

# Gabriel<sup>®</sup> HD

THE ORIGINAL

# 2025

## HD TRUCK, TRAILER, AND BUS SHOCKS CATALOG



**SCAN TO WATCH!**  
*See how to properly check  
for worn HD shocks!*



Gabriel.com

# Table of Contents

New Part Numbers / Part Numbers Discontinued.....	2
<b>Application and Numerical Listings</b>	
Shocks for Heavy Duty Trucks, Trailers and Buses - Application Listing.....	4
Shocks for Heavy Duty Trucks, Trailers and Buses - Numerical Listing.....	232
Competitive and OEM Interchange.....	275
Fleetline / GasSLX Interchange.....	422
How to Determine the Correct Shock for Your Truck.....	423
Specifications by End Mount.....	434
Specifications by Part Number.....	449
Mounting Accessory Packages and Component Parts.....	464
Mounting Accessory Packages - Buyer's Guide .....	471

**NEW PART NUMBERS IN THIS CATALOG  
NOUVEAUX NUMÉROS DE PIÈCES DANS CE CATALOGUE  
NUMERACION NUEVA DE PARTES EN ESTE CATALOGO**

85205

**PART NUMBERS TO BE DISCONTINUED ONCE INVENTORY IS GONE  
LES NUMÉROS DE PIÈCE SERONT DISCONTINUÉS UNE FOIS L'INVENTAIRE ÉPUISE  
NÚMEROS DE PIEZA QUE SE DESCONTINUARAN UNA VEZ QUE SE HAYA TERMINADO EL INVENTARIO**

83065

83113

83180

85180

85351



# **Heavy Duty Shocks for Trucks, Trailers and Buses**

(Alphabetical Listing)

(Numerical Listing)

# **Amortiguadores Para Vehículos Pesados Camiones, Remolques Y Autobuses**

(Lista alfabética)

(Listado numérico)

# **Amortisseurs Pour Poids Lourds Camions, Remorques et Autobus**

(Liste alphabétique)

(Ordre numérique)

**Gabriel<sup>®</sup> HD**  
**THE ORIGINAL**



# APPLICATION GUIDE

Year	Fitment Notes	OEM#					
			Fleetline	GasSLX	Fleetline	GasSLX	Cab Shock Specialty Shock

## AUTOCAR LLC.

## AUTOCAR LLC.

### ADDITIONAL APPLICATIONS (cont)

	DC87T, DC9364 From Feb. 1971 89000 Series	.....	O		89406				
	Models with Air Suspension and O.E.M. Number 85000 Series	8071524	O			85024			
		8026658	O			85046			
	Models with Air Suspension and O.E.M. Number 89000 Series	8026658	O			89434			
	Models with Hendrickson HTS 210, HTS 230 and HTS 260 Suspensions 85000 Series	60665-025 60665-025L	O			85036			
	Models with Hendrickson HTS 210, HTS 230 and HTS 260 Suspensions 89000 Series	60665-025 60665-025L	O			89405			
	Models with O.E.M. Number 83000 Series	28CFG-910Z 849246 660186 28CFG-910 1011839	O		83216				
	Models with O.E.M. Number 85000 Series	37301-3202	O		85026				

### DC-64

24	Models with 20,000 lb Front Axle 85000 Series	A3711405-001	O		85908				
	Models with Hendrickson HMX 400 Haulmax with 16.5" Saddle 83000 Series	60680-004L 60680-004	O			83143			
	Models with Hendrickson HMX 400 Haulmax with 17.5" & 18.5" Saddle 83000 Series	60680-005L 60680-005	O			83142			
	Models with Hendrickson HN - 522 83000 Series	60680-003L 60680-003	O			83112			
	Models with Hendrickson Primaax EX 462 Air Suspensions with 8 1/2" to 10" Ride Height 85000 Series	60657-003 60657-003L	O			85072			
20-23	Models with 20,000 lb Front Axle	A3711405-001	O		85908				
	Models with Hendrickson HMX 400 Haulmax with 16.5" Saddle	60680-004L 60680-004	O			83143			
	Models with Hendrickson HMX 400 Haulmax with 17.5" & 18.5" Saddle	60680-005L 60680-005	O			83142			
	Models with Hendrickson HN - 522	60680-003L 60680-003	O			83112			
	Models with Hendrickson Primaax EX 462 Air Suspensions with 8 1/2" to 10" Ride Height	60657-003 60657-003L	O			85072			

### XPEDITOR

08-23	4 X 2 Models with Hendrickson Primaax EX 232 Air Suspensions with 8 1/2" to 10" Ride Height	60657-003 60657-003L				O		85072		
	6 X 4 Models with Hendrickson HMX 400/460 Haulmax with 16.5" Saddle	60680-004L 60680-004	O			83143				
	6 X 4 Models with Hendrickson HMX 400/460 Haulmax with 17.5" & 18.5" Saddle	60680-005L 60680-005	O			83142				
	6 X 4 Models with Hendrickson HN - 522	60680-003L 60680-003	O			83112				
	6 X 4 Models with Hendrickson Primaax EX 462 Air Suspensions with 8 1/2" to 10" Ride Height	60657-003 A3591004-001 60657-003L	O			85072				
	8 X 4 Models with Hendrickson Primaax EX 462 Air Suspensions with 8 1/2" to 10" Ride Height	60657-003 A3591004-001 60657-003L	O			85072				
	Models with Hendrickson Primaax EX 462 Air Suspensions with 12 1/2" - 14 3/8" - 15 1/2" Ride Height	60665-011	O			85967				
16-21	Models with 20,000 lb Front Axle	A3730008-001	O		85086					
08-20	8 X 4 Models with Chalmers 800 Series - 46K Tandem Truck Suspensions ( HD Shock Kit with High Mounts)	800670	O			85060				
	8 X 4 Models with Chalmers 800 Series - 46K Tandem Truck Suspensions ( HD Shock Kit with Low Mounts)	800781	O			85314	89425			
09-12	Models with 20,000 lb Front Axle	3946210	I		83103					

### XPERT

16-24	Models with Hendrickson HTS 210 Suspension	60665-025 60665-025L				O		85036	89405	
14-24	Models with Hendrickson HAS-210 or HAS-230 Air Suspensions	60670-005 60670-005L	O			83137				
14-23	4 X 2 Models (CLASS 8) with Hendrickson EX-262 Air Suspensions	60665-013	O			85965				





# APPLICATION GUIDE

Year	Fitment Notes	OEM#					
			Fleetline	GasSLX	Fleetline	GasSLX	Cab Shock/ Specialty Shock

## BLUE BIRD

## BLUE BIRD

### ADDITIONAL APPLICATIONS

	Buses with 3/4" Mounting Pins 85000 Series	2021459	O	85012	....					
	Buses with 3/4" Mounting Pins 89000 Series	2021459	OO	....	89413					
	Buses with 35" Chassis 85000 Series	303-1350628 90-1968	OO	85712	....					
	Buses with Flat Leaf Rear Spring Suspensions (8,200 lb to 10,400 lb) 85000 Series	1707405		....	....	O	85005	....	....	
	Buses with Flat Leaf Rear Spring Suspensions (8,200 lb to 10,400 lb) 89000 Series	1707405		....	....	OO	....	89430	....	
	Buses with Neway Air Suspensions with O.E.M. Number 83000 Series	90044915		....	....	O	83127	....	....	
	Buses with Neway Air Suspensions with O.E.M. Number 85000 Series	90044448		....	....	OO	85051	....	....	
		1526417		....	....	OO	85052	....	....	
		90045083		....	....	OO	85910	....	....	
	Buses with Reyco Air Suspension 85000 Series	1668722	OO	85030	....		....	....	....	
		1668730 1722222		....	....	OO	85013	....	....	
		1668722	OO	....	89440			....	....	
	Buses with Reyco Air Suspension 89000 Series	1668730 1722222		....	....	OO	....	89414	....	
		City Bird Buses with 1 " Mounting Pins 85000 Series	614958 00614966 300-0614966	OO	85307	....		....	....	....
			300-0614974 609180		....	....	OO	85304	....	....
	Low Floor Bus Models with O.E.M. Number 85000 Series	4760958 0075916	OO	85086	....		....	....	....	
	Low Floor Bus Models with O.E.M. Number 89000 Series	4759272		....	....	T	....	89447	....	
	Models with O.E.M. Number 85000 Series	65992-004 00119798	OO	85106	....		....	....	....	
		614974	OO	85304	....		....	....	....	
		300-1316546		....	....	OO	85006	....	....	
		0020326		....	....	OO	85976	....	....	
	Models with O.E.M. Number 89000 Series	2310601 23106-01		....	....	OO	....	89430	....	

### ALL AMERICAN FE

04-24	Buses with Hendrickson Airtek Front Air Suspension (10,000 lb Capacity)	58913-009L 0055017 58913-008L 00119797 0085990 58913-008 65992-003 58913-009 471700000456	OO	85959	....				
	Buses with Hendrickson Airtek Front Air Suspension (13, 200 to 14,600 lb Capacity)	58913-011L 58913-011	OO	85959	....				
	Buses with Hendrickson Softek Suspension (8,500 lb - 10,000 lb Capacity)	58913-009L 0085990 58913-007L 58913-007 58913-009 0055008 471700000456		OO	85959	....			
89-24	Buses with Comfort Air Suspensions	471700131545 471700000428 60998-001 60998-003 00085991		....	....	O	85006	....	....
	Buses with Leaf Spring Rear Suspension	0088035 471700000464		....	....	OO	85090	....	....
00-22	Models with Hendrickson HAS-210 or HAS-230 Air Suspensions	060665-003 59057-001 0014985 60665-003		....	....	OO	83137	....	....





# APPLICATION GUIDE

Year	Fitment Notes	OEM#					
			Fleetline	GasSLX	Fleetline	GasSLX	Cab Shock/ Specialty Shock

## BLUE BIRD

## BLUE BIRD

### D3 SERIES (FE & RE MODELS)

10-13	Buses with Comfort Air Suspensions 85000 Series	47170000428 60998-001 60998-003 00085991	....	....	85006	....	....
	Buses with Hendrickson Airtek Front Air Suspension (13, 200 to 14,600 lb Capacity) 85000 Series	58913-011L 58913-011	OO	85959	....	....	....
	Buses with Hendrickson Airtek Front Air Suspension 83000 Series	00110808	OO	83124	....	....	....
	Buses with Hendrickson Airtek Front Air Suspension 89000 Series	00110808	OO	....	89407	....	....
	Buses with Hendrickson Softek Suspension (13,200 lb - 14,600 lb Capacity) 85000 Series	0106303 471700002919 58913-010L 58913-010	OO	85106	....	....	....
	Buses with Leaf Spring Rear Suspension 85000 Series	0088035 47170000464	OO	....	....	85090	....

### MOTORHOMES

	Blue Bird Motor Home with IFS (37 Foot) 85000 Series	7805-S-1007 7805-N-1002	OO	85329	....	....	....
	WanderLodge 85000 Series	90-1968-SP1	OO	85712	....	....	....
	WanderLodge LX, LXI - Models 85000 Series	90-1951-SP1	OO	....	....	85734	....

### TC2000

89-04	Buses with Ridewell Front Suspension with O.E.M. Number	AMS65119 1317767 300-1317767 1667831	OO	85029	....	....	....
		1004167	OO	85712	....	....	....
	Buses with Ridewell Rear Suspension with O.E.M. Number	1658533	OO	....	....	85010	....
		305-0961284	OO	....	....	85734	....
	Buses with Standard Flat Leaf Rear Springs	1316546 1746163	OO	....	....	85006	....

### VISION SCHOOL BUS

04-24	Buses with Comfort Air Suspensions	471700131545 47170000428 60998-001 60998-003 00085991	....	....	85006	....	....
	Buses with Hendrickson Airtek Front Air Suspension (10,000 lb Capacity)	58913-009L 0055017 58913-008L 00119797 0085990 58913-008 65992-003 58913-009 47170000456	OO	85959	....	....	....
	Buses with Hendrickson Airtek Front Air Suspension (13, 200 to 14,600 lb Capacity)	00119797 65992-003 58913-011L 58913-011	OO	85959	....	....	....
	Buses with Hendrickson Softek Suspension (8,500 lb - 10,000 lb Capacity)	58913-009L 0085990 58913-007L 58913-007 58913-009 0055008 47170000456	OO	85959	....	....	....
	Buses with Leaf Spring Rear Suspension	0088035 47170000464	OO	....	....	85090	....
10-19	Buses with Hendrickson Softek Suspension (13,200 lb - 14,600 lb Capacity)	0106303 471700002919 58913-010L 58913-010	OO	85106	....	....	....

### WANDERLODGE

	Models with O.E.M. Number 85000 Series	1750793	....	....	85712	....	....
	Models with Reyco Air Suspension 85000 Series	01722214	OO	....	....	85030	....
	Models with Reyco Air Suspension 89000 Series	01722214	OO	....	....	89440	....



# APPLICATION GUIDE

Year	Fitment Notes	OEM#					
			Fleetline	GasSLX	Fleetline	GasSLX	Cab Shock Specialty Shock

## CATERPILLAR

## CATERPILLAR

### CT660

11-17	Models with Hendrickson HMX 400/460 Haulmax with 16.5" Saddle	60680-004L 60680-004 H60680-004	....	....		83143	....	....
	Models with Hendrickson HMX 400/460 Haulmax with 17.5" & 18.5" Saddle	60680-005L HDR60680-005 60680-005	....	....		83142	....	....
	Models with Hendrickson Primaax EX 232, 462 and 692 Air Suspension (13" Ride Height)	60665-011L 60665-011L 060665-011	....	....		85967	....	....
	Models with Hendrickson Primaax EX 232, 462 and 692 Air Suspension (8-1/2" to 10" Ride Height)	60657-003 60657-003L	....	....		85072	....	....

### CT680

16-17	Models HAS-402 Hendrickson Air Suspensions	60670-005 60670-005L	....	....		83137	....	....
-------	--	-------------------------	------	------	--	-------	------	------

### CT681

14-17	Models with Hendrickson HMX 400/460 Haulmax with 16.5" Saddle	60680-004L 60680-004 H60680-004	....	....		83143	....	....
	Models with Hendrickson HMX 400/460 Haulmax with 17.5" & 18.5" Saddle	60680-005L HDR60680-005 60680-005	....	....		83142	....	....

## CHALLENGE COOK

## CHALLENGE COOK

### CEMENT TRUCK

	Cement Trucks with 1/2" Bearing mount Specialty Shock	632147				632147		
	Cement Trucks with 3/4" Bushing & Sleeve mount Specialty Shock	1540212 1540459				646155		
		632155				646177		

## CHALMERS SUSPENSION

## CHALMERS SUSPENSION

### VARIOUS

	800 Series - 46K Tandem Truck Suspensions ( HD Shock Kit with High Mounts) 85000 Series	800670 665174	....	....		85060	....	....
	800 Series - 46K Tandem Truck Suspensions ( HD Shock Kit with Low Mounts) 85000 Series	800781	....	....		85314	....	....
	800 Series - 46K Tandem Truck Suspensions ( HD Shock Kit with Low Mounts) 89000 Series	800781	....	....		....	89425	....
	K800199 Model Shock Kit (Stanard) 85000 Series	K800199 665174	....	....		85060	....	....
	K880233 Model Shock Kit (Standard 50K Suspension) 85000 Series	K880233 665174	....	....		85060	....	....
	K880247 Model Shock Kit 85000 Series	665174 K880247	....	....		85060	....	....
	K880248 Model Shock Kit 85000 Series	K880248	....	....		85314	....	....
	K880248 Model Shock Kit 89000 Series	K880248	....	....		....	89425	....
	K880642 Model Shock Kit (Used on Western Star only) 85000 Series	K880642 665174	....	....		85060	....	....
	Single Axle Truck Suspension (1023-23K, 1030 -30K, 1040-40K) 85000 Series	665174	....	....		85060	....	....

## CHAMPION BUS INC.

## CHAMPION BUS INC.

	GMC P6000 Chassis 83000 Series	22064230				83136	....	
--	--------------------------------	----------	--	--	--	-------	------	--

## CHANCE COACH TRANSIT BUS

## CHANCE COACH TRANSIT BUS

	Buses with 3/4" Mounting Pins 85000 Series	2021459				85012	....	
	Buses with 3/4" Mounting Pins 89000 Series	2021459				....	89413	
	Models with O.E.M. Number 83000 Series	6893 728600				83203	....	
		6892 59039				83207	....	
	Models with O.E.M. Number 85000 Series	AS789B				85014	....	

# APPLICATION GUIDE

Year	Fitment Notes	OEM#					
			Fleetline	GasSLX	Fleetline	GasSLX	Cab Shock\ Specialty Shock

## CHANCE COACH TRANSIT BUS VARIOUS (cont)

## CHANCE COACH TRANSIT BUS

Models with O.E.M. Number 89000 Series	6892 59039	OIO	....	89407	OIO	....	....	....
	6893 728600	OIO	....	89436	OIO	....	....	....

## CHEVROLET

## CHEVROLET

### 6, 60, 6000 & 6500 SERIES

79-89	B6P042 School Bus (Axle codes F090, F120D) 83000 Series	22007753 22002295 22017531	OIO	83303	....	OIO	....	....
	B6P042 School Bus w/15000 lb. or 17000 lb. Rear Springs 83000 Series	22012169 22012096	OIO	....	....	OIO	83221	....
	B6P042 School Bus w/18500 or 20800 lb. Rear Springs 83000 Series	22012166 22012095	OIO	....	....	OIO	83126	....
	B6P042 School Bus w/18500 or 20800 lb. Rear Springs 89000 Series	22012166 22012095	OIO	....	....	OIO	....	89430
79-80	W Chassis - 72" BBC Steel Tilt Cab 83000 Series	22002293	OIO	83126	....	OIO	....	....
		22007751	OIO	83303	....	OIO	....	....
	W Chassis - 72" BBC Steel Tilt Cab 89000 Series	22002293	OIO	....	89430	OIO	....	....
75-80	C, M, S Chassis - Conventional Cab and School Bus 83000 Series	4975510	OIO	83221	....	OIO	....	....
73-80	C, S, T Chassis - Conventional & Tilt Cab and School Bus with 5000 & 7000 lb. Axle 83000 Series	4940606 4975497 22007701 4940662 22002293 3192890 22012095	OIO	83126	....	OIO	....	....
		22007751	OIO	83303	....	OIO	....	....
	C, S, T Chassis - Conventional & Tilt Cab and School Bus with 5000 & 7000 lb. Axle 89000 Series	4940606 4975497 22007701 4940662 22002293 3192890 22012095	OIO	....	89430	OIO	....	....
76-78	SE-60 w/Hydraulic Brakes from Serial # 120000 (1975 2nd Design) 83000 Series	22012169 3192892	OIO	....	....	OIO	83221	....
73-78	S-60 w/Air Brakes 83000 Series	22007751	OIO	83303	....	OIO	....	....
		4940606 22012166 22007701 22012095	OIO	....	....	OIO	83126	....
		3171069	OIO	....	....	OIO	85304	....
	S-60 w/Air Brakes 89000 Series	4940606 22012166 22007701 22012095	OIO	....	....	OIO	....	89430
69-78	S-60 83000 Series	4975510 3192892	OIO	83221	....	OIO	....	....
73-75	C, M, S Chassis - Conventional Cab and School Bus with 5000 & 7000 lb. Axle 83000 Series	22007750 4975494 4975467	OIO	83207	....	OIO	....	....
		22007750 4975494 4975467	OIO	....	89407	OIO	....	....
	SE, SS-60 thru Serial # 134487 (1975 1st Design) 83000 Series	22007750 4975494 22007700 4975467	OIO	83207	....	OIO	....	....
	SE, SS-60 thru Serial # 134487 (1975 1st Design) 89000 Series	22007750 4975494 22007700 4975467	OIO	....	89407	OIO	....	....
73-74	SG, SM-60 83000 Series	3192890	OIO	83126	....	OIO	....	....
	SG, SM-60 89000 Series	3192890	OIO	....	89430	OIO	....	....
	SG, SM-61 83000 Series	4940606	OIO	83126	....	OIO	....	....
	SG, SM-61 89000 Series	4940606	OIO	....	89430	OIO	....	....

# APPLICATION GUIDE

Year	Fitment Notes	OEM#					
			Fleetline	GasSLX	Fleetline	GasSLX	Cab Shock/ Specialty Shock

## CHEVROLET

## CHEVROLET

### 6, 60, 6000 & 6500 SERIES (cont)

73-74	SG, SM-62 83000 Series	22002293	O	83126	....				
	SG, SM-62 89000 Series	22002293	OO	....	89430				
	SG, SM-63 83000 Series	22007701	OO	83126	....				
	SG, SM-63 89000 Series	22007701	OO	....	89430				
	SG, SM-64 83000 Series	22007751	OO	83303	....				
71-72	Conventional Cab & Tilt Cab with 9000 & 11000 lb. Axles 83000 Series	4940606 22012095	O	....	....	O	83126	....	....
	Conventional Cab & Tilt Cab with 9000 & 11000 lb. Axles 89000 Series	4940606 22012095	O	....	....	O	....	89430	....
	TDM 4 Cycle Detroit Diesel with Tandem Axle 83000 Series	4940606 22012095	O	....	....	O	83126	....	....
	TDM 4 Cycle Detroit Diesel with Tandem Axle 89000 Series	4940606 22012095	O	....	....	O	....	89430	....
69-72	All - Exc. Tilt Cab 83000 Series	22012096 3192892	OO	83221	....				
69-70	D - D Forward Control with 9000 & 11000 lb. Axles - Exc. Tilt Cab 83000 Series	22012096 3192892	OO	83221	....				
68-69	All with 9000 & 11000 lb. Axles - Exc. Tilt Cab 83000 Series	4940606 22012095	OO	83126	....				
	All with 9000 & 11000 lb. Axles - Exc. Tilt Cab 89000 Series	4940606 22012095	OO	....	89430				
67-68	TDM 4 Cycle Detroit Diesel with Tandem Axle - Exc. Tilt Cab 83000 Series	22012096 3192892	O	....	....	O	83221	....	....
68	Cowl - Exc. School Bus 83000 Series	22012096 3192892	OO	83221	....				

### 7, 70 & 7000 SERIES

79-89	C, M Chassis - 97" BBC Conventional Cab 83000 Series	22007753 22002295 22017531 22017530	OO	83303	....				
	C, M Chassis - 97" BBC Conventional Cab 89000 Series	22012166 22012095	O	....	....	O	83126	....	....
83-84	S7T042 Forward Control Chassis w/17000, 18500, 21000, 23000 lb. Rear Axle 83000 Series	22012166 22012095	O	....	....	O	83126	....	....
	S7T042 Forward Control Chassis w/17000, 18500, 21000, 23000 lb. Rear Axle 89000 Series	22012166 22012095	O	....	....	O	....	89430	....
	STT042 Forward Control Chassis 85000 Series	3171069 22012065	OO	85304	....				
77-80	H, J Chassis - 92" BBC Conventional Cab 83000 Series	4963854 4984526	OO	83216	....				
73-80	H, J Chassis - 92" BBC Conventional Cab with V-6, V8 Diesel Engines 83000 Series	4940614 4963854	OO	83216	....				
	H, J, M Chassis - 92" & 114" BBC Conventional Cab 85000 Series	3171069 2204683	OO	85304	....				
	R Chassis - Rear Engine Bus 85000 Series	22012090 5552451	OO	85308	....				
		5552552	O	....	....	O	85303	....	....
		5552456	O	....	....	O	85307	....	....
	R Chassis - Rear Engine Bus 89000 Series	22012090 5552451	OO	....	89422				
		5552552	O	....	....	O	....	89422	....
	T, W Chassis - 72" BBC Steel Tilt Cab (4 x 2) with V-6 Diesel Engine 83000 Series	4940606 4975497 22012095	OO	83126	....				
22007751		OO	83303	....					
T, W Chassis - 72" BBC Steel Tilt Cab (4 x 2) with V-6 Diesel Engine 89000 Series	4940606 4975497 22012095	OO	....	89430					
T, W Chassis - 72" BBC Steel Tilt Cab with V-6 Gas Engine 85000 Series	22012091 5552452	OO	85303	....					
T, W Chassis - 72" BBC Steel Tilt Cab with V-6 Gas Engine 89000 Series	22012091 5552452	OO	....	89422					



# APPLICATION GUIDE

Year	Fitment Notes	OEM#					
			Fleetline	GasSLX	Fleetline	GasSLX	Cab Shock\ Specialty Shock

## CHEVROLET

## CHEVROLET

### 7, 70 & 7000 SERIES (cont)

66-72	72" BBC Steel Tilt Cab with V-6 2 Cycle Diesel Engine 83000 Series	3171462 3192890 22012095	OIO	83126	....	....	....	....
	72" BBC Steel Tilt Cab with V-6 2 Cycle Diesel Engine 89000 Series	3171462 3192890 22012095	OIO	....	89430	....	....	....
	72" BBC Steel Tilt Cab with V-6 2 Cycle Diesel Engine with 17201 and 17221 Axle 83000 Series	22012096 3192892	OIO	....	....	83221	....	....
	72" BBC Steel Tilt Cab with V-6 2 Cycle Diesel Engine with 19101 and 19201 Axle 83000 Series	4940600	OIO	....	....	83209	....	....
	72" BBC Steel Tilt Cab with V-6 2 Cycle Diesel Engine with 19101 and 19201 Axle 89000 Series	4940600	OIO	....	....	....	89414	....
	92" BBC Conventional Cab 83000 Series	4940614 3192657 4963854	OIO	83216	....	....	....	....
	Conventional Cab with Tapered 2-Leaf Softride 11000 lb. Rating and F120 Axle (12000 lb.) 85000 Series	3171069 22052336 22046483	OIO	85304	....	....	....	....
	Conventional Cab With Tapered 2-Leaf Softride 7000 & 9000 lb. Rating and F070, F090, F120 Axle (7000, 9000 & 12000 lb.) 83000 Series	3171068 4940614 3192657 4963854 4963853	OIO	83216	....	....	....	....

### 8, 80 & 8000 SERIES

73-86	H, J, M Chassis - 92" & 114" BBC Conventional Cab 85000 Series	3171069 22052336 22046483	OIO	85304	....	....	....	....
79-82	H, J Chassis - 92" BBC Conventional Cab 4 x 2 with Air Suspension 85000 Series	3171069 22052336 22012065 22046483	OIO	....	....	85304	....	....
73-81	H, J Chassis - 92" BBC Conventional Cab 83000 Series	4940614 4963854 4984526	OIO	83216	....	....	....	....
73-80	R Chassis - Rear Engine Bus 85000 Series	22012090 5552451	OIO	85308	....	....	....	....
		22012091 5552452	OIO	....	....	85303	....	....
		5552456	OIO	....	....	85307	....	....
	R Chassis - Rear Engine Bus 89000 Series	22012090	OIO	....	89422	....	....	....
		5552451	OIO	....	89422	....	....	....
22012091	OIO	....	....	....	89422	....	....	
5552452	OIO	....	....	....	89422	....	....	
70-80	T, W Chassis - 72" BBC Steel Tilt Cab with V-6 Gas Engine 85000 Series	22012091 5552452	OIO	85303	....	....	....	....
	T, W Chassis - 72" BBC Steel Tilt Cab with V-6 Gas Engine 89000 Series	22012091 5552452	OIO	....	89422	....	....	....
66-72	92" BBC Conventional Cab 83000 Series	3171068 4940614 3192657 4963854 4963853	OIO	83216	....	....	....	....
	92" BBC Conventional Cab with 7000 & 9000 lb. Axles - Exc. 2-Leaf Softride 85000 Series	3171069 22052336 22046483	OIO	85304	....	....	....	....
66-69	72" BBC Steel Tilt Cab 85000 Series	5544060	OIO	85302	....	....	....	....
	72" BBC Steel Tilt Cab 89000 Series	5544060	OIO	....	89420	....	....	....

### 9000 SERIES

77-86	M, N Chassis - 114" BBC Conventional & 108" BBC Aluminum Conventional Cab with Rear GM Air-Ride Suspension (4 Req'd) 85000 Series	3171069 22052336 22012065 22046483	OIO	85304	....	....	....	....
70-86	D, F Chassis - 54" BBC Aluminum Tilt Cab with Rear GM Air Ride Suspension (4 Req'd) 85000 Series	3171069 22052336 22012065 22046483	OIO	85304	....	....	....	....
	H, J Chassis - 92" BBC Conventional Cab 85000 Series	3171069 22052336 22046483	OIO	85304	....	....	....	....

# APPLICATION GUIDE

Year	Fitment Notes	OEM#					
			Fleetline	GasSLX	Fleetline	GasSLX	Cab Shock Specialty Shock

## CHEVROLET

## CHEVROLET

### 9000 SERIES (cont)

70-80	T, W Chassis - 72" BBC Steel Tilt Cab 85000 Series	22012091 5552452	O O	85303	....	....	....	....
	T, W Chassis - 72" BBC Steel Tilt Cab 89000 Series	22012091 5552452	O O	....	89422	....	....	....
70-72	54" BBC Aluminum Tilt Cab 6 x 4 85000 Series	3171069 22052336 22046483	O O O	85304	....	....	....	....
	92" & 114" BBC Conventional Cab - Exc. 6 x 4 83000 Series	4940614 4963854	O O	83216	....	....	....	....
	92" & 114" BBC Conventional Cab 6 x 4 85000 Series	3171069 22052336 22046483	O O O	85304	....	....	....	....

### B - SERIES - SCHOOL BUS

	Models with O.E.M. Number 83000 Series	88982682 15588554 22064230 15123676	 	83136	....	....	....	....
--	--	--	------	-------	------	------	------	------

#### B6

90-07	B6, B7 Model School Bus Chassis With 15000, 19000, 21000 lb Multileaf Springs 85000 Series	15174902 22064232		....	....	 	85071	....	....
-------	--	----------------------	--	------	------	------	-------	------	------

#### B7

93-02	With 15000, 19000, 21000 lb Multileaf Springs	15174902 22064232		....	....	 	85071	....	....
-------	---	----------------------	--	------	------	------	-------	------	------

### C - SERIES (C6500, C7500, C8500) KODIAK

	Models with O.E.M. Number 83000 Series	88982684	 	83136	....	....	....	....
--	--	----------	------	-------	------	------	------	------

#### C70 KODIAK

90-96	Conventional Cab w/ Front Shock with O.E.M. Number	88982682 15588554 15887728 15174898 19152843 22064230 15123676	 	83136	....	....	....	....	
	Conventional Cab w/15000, 19000, 21000 lb Multileaf Springs	15174902 88982686 22064232	 	....	....	 	85071	....	....
	Conventional Cab w/19000, 21000, 23000 lb Taperleaf Springs (EXC Low Profile Vehicle)	22064233	 	....	....	 	83136	....	....
	Truck Cabs with Link Cabmate Model GMC104TK	1201-0054 1202-0054	O O	....	....	O O	....	....	83021

#### C4500 KODIAK

90-02	C Chassis - Conventional Cab 83000 Series	88982682 15588554 15887728 19152843 22064230 15123676	 	83136	....	....	....	....	
	C Chassis - Conventional Cab w/19000, 21000, 23000 lb Taperleaf Springs (EXC Low Profile Vehicle) 83000 Series	22064233	 	....	....	 	83136	....	....
	C Chassis - Conventional Cab With 15000, 19000, 21000 lb Multileaf Springs 85000 Series	15174902 88982686 22064232	 	....	....	 	85071	....	....
83-99	C Chassis - Conventional Cab with 9100 to 17500 lb Rear Axle 83000 Series	22064432	O O	....	....	O O	83221	....	....

#### C5500 KODIAK

92-02	C Chassis - Conventional Cab 83000 Series	88982682 15588554 15887728 19152843 22064230 15123676	 	83136	....	....	....	....	
	C Chassis - Conventional Cab w/19000, 21000, 23000 lb Taperleaf Springs (EXC Low Profile Vehicle) 83000 Series	22064233	 	....	....	 	83136	....	....
	C Chassis - Conventional Cab With 15000, 19000, 21000 lb Multileaf Springs 85000 Series	15174902 88982686 22064232	 	....	....	 	85071	....	....
92-99	C Chassis - Conventional Cab with 9100 to 17500 lb Rear Axle 83000 Series	22064432	O O	....	....	O O	83221	....	....



# APPLICATION GUIDE

Year	Fitment Notes	OEM#					
			Fleetline	GasSLX	Fleetline	GasSLX	Cab Shock Specialty Shock

## CHEVROLET

## CHEVROLET

### C7500 KODIAK (cont)

83-96	Conventional Cab with 9100 to 17500 lb Rear Axle 83000 Series	22064432	....	....	83221	....	....
-------	---	----------	------	------	-------	------	------

### C8500

03-09	Models with Hendrickson Air Suspension (Stamping number 47902-13)	12474915 15963161	....	....	83122	89406	....
	Models with Hendrickson Air Suspension with O.E.M. Number	60670-005 060665-003 12474917 15740554 59057-001 47902-29	....	....	83137	....	....

### T5500

97-09	FL1 Tilt Cab with 8100 lb Axle 83000 Series	22165188 22165187 22064804 22064805	83136	....	....	....	....
	FL2 Tilt Cab with 5000 to 11000 lb Axle 83000 Series	22166442 22064807	83136	....	....	....	....
	FL3 Tilt Cab with 14575 lb Axle 83000 Series	22165189 22064806	83136	....	....	....	....
90-06	Tilt Cab w/15000, 19000, 21000 lb Multileaf Springs 85000 Series	15174902 22064232	....	....	85071	....	....
92-99	Tilt Cab w/19000, 21000, 23000 lb Taperleaf Springs (EXC Low Profile Veh.) 83000 Series	22064233	....	....	83136	....	....

### T6500

03	FL1 Tilt Cab with 8100 lb Axle 83000 Series	22165188 22165187 22064804 22064805	83136	....	....	....	....
	FL2 Tilt Cab with 5000 to 11000 lb Axle 83000 Series	22166442 22064807	83136	....	....	....	....
	FL3 Tilt Cab with 14575 lb Axle 83000 Series	22165189 22064806	83136	....	....	....	....
	Tilt Cab w/15000, 19000, 21000 lb Multileaf Springs 85000 Series	15174902 22064232	....	....	85071	....	....
92-96	Tilt Cab w/19000, 21000, 23000 lb Taperleaf Springs (EXC Low Profile Veh.) 83000 Series	22064233	....	....	83136	....	....
90-96	Tilt Cab w/15000, 19000, 21000 lb Multileaf Springs 85000 Series	15174902 22064232	....	....	85071	....	....

### T7500

04-09	FL1 Tilt Cab with 8100 lb Axle	22165188 22165187 22064804 22064805	83136	....	....	....	....
	FL2 Tilt Cab with 5000 to 11000 lb Axle	22166442 22064807	83136	....	....	....	....
	FL3 Tilt Cab with 14575 lb Axle	22165189 22064806	83136	....	....	....	....
04-06	Tilt Cab w/15000, 19000, 21000 lb Multileaf Springs	15174902 22064232	....	....	85071	....	....
03	FL1 Tilt Cab with 8100 lb Axle 83000 Series	22165188 22165187 22064804 22064805	83136	....	....	....	....
	FL2 Tilt Cab with 5000 to 11000 lb Axle 83000 Series	22166442 22064807	83136	....	....	....	....
	FL3 Tilt Cab with 14575 lb Axle 83000 Series	22165189 22064806	83136	....	....	....	....
	Tilt Cab w/15000, 19000, 21000 lb Multileaf Springs 85000 Series	15174902 22064232	....	....	85071	....	....
97-02	FL1 Tilt Cab with 8100 lb Axle	22165188 22165187 22064804 22064805	83136	....	....	....	....
	FL2 Tilt Cab with 5000 to 11000 lb Axle	22166442 22064807	83136	....	....	....	....
	FL3 Tilt Cab with 14575 lb Axle	22165189 22064806	83136	....	....	....	....
	Tilt Cab w/15000, 19000, 21000 lb Multileaf Springs	15174902 22064232	....	....	85071	....	....



# APPLICATION GUIDE

Year	Fitment Notes	OEM#					
			Fleetline	GasSLX	Fleetline	GasSLX	Cab Shock/ Specialty Shock

## COACHMEN

## COACHMEN

### AURORA (cont)

09	MotorHomes with Ford F53 Chassis with 16,000 lb GVW to 22,000 lb GVW 83000 Series	ASH-1206 9U94-18080-AA AT-621 ASH-25824 9U9Z-18125-A ASH-1023 ASH-1230 ASH-137	....	....	83122	....	....	
	MotorHomes with Ford F53 Chassis with 16,000 lb GVW to 22,000 lb GVW 89000 Series	ASH-1229 ASH-1228 9U94-18045-AA ASH-1205 AT-620 ASH-1022 1C34-18045-AA ASH-294 9U9Z-18124-A ASH-25822 ASH-25823 1C34-18045-JA AT-766	OO	....	89414	....	....	....
		ASH-1206 9U94-18080-AA AT-621 ASH-25824 9U9Z-18125-A ASH-1023 ASH-1230 ASH-137	....	....	....	89406	....	....
07	MotorHomes with Ford F53 Chassis with 16,000 lb GVW to 22,000 lb GVW 83000 Series	ASH-1229 ASH-1228 9U94-18045-AA ASH-1205 AT-620 ASH-1022 1C34-18045-AA ASH-294 9U9Z-18124-A ASH-25822 ASH-25823 1C34-18045-JA AT-766	OO	83209	....	....	....	
		ASH-1206 9U94-18080-AA AT-621 ASH-25824 9U9Z-18125-A ASH-1023 ASH-1230 ASH-137	....	....	83122	....	....	
	MotorHomes with Ford F53 Chassis with 16,000 lb GVW to 22,000 lb GVW 89000 Series	ASH-1229 ASH-1228 9U94-18045-AA ASH-1205 AT-620 ASH-1022 1C34-18045-AA ASH-294 9U9Z-18124-A ASH-25822 ASH-25823 1C34-18045-JA AT-766	OO	....	89414	....	....	....
	ASH-1206 9U94-18080-AA AT-621 ASH-25824 9U9Z-18125-A ASH-1023 ASH-1230 ASH-137	....	....	....	89406	....	....	

### CLASS A MOTORHOMES

	MotorHomes with Freightliner XC Chassis 83000 Series	66153-002 F4-BE5-C832-MO	OO	83124	....	....	....
	MotorHomes with Freightliner XC Chassis 89000 Series	66153-002 F4-BE5-C832-MO	OO	....	89407	....	....

### CROSS COUNTRY

06	MotorHomes with Freightliner XC Chassis ADL200 Suspension w/ 20K Rear 85000 Series	16-16873-000	....	....	85029	....	....
	MotorHomes with Freightliner XC Chassis AS120 Front Suspension 83000 Series	16-16874-000 16-16737-000 141700131810	OO	83160	....	....	....



# APPLICATION GUIDE

Year	Fitment Notes	OEM#					
			Fleetline	GasSLX	Fleetline	GasSLX	Cab Shock\ Specialty Shock

## COACHMEN

## COACHMEN

### CROSS COUNTRY (cont)

06	MotorHomes with Freightliner XC Chassis Rear Shock with O.E.M. Number 85000 Series	141700131809 16-16736-000		....	....	O	85029	....	....
	MotorHomes with Freightliner XC Chassis ZF - IFS Front Suspension with 23,000 lb GVW or Greater 85000 Series	16-18103-000 481700000493		85900	....	....	O	....	....

### CROSS COUNTRY ELITE

03-05	MotorHomes with Freightliner XC Chassis ADL200 Suspension w/ 20K Rear 85000 Series	16-16873-000		....	....	O	85029	....	....
	MotorHomes with Freightliner XC Chassis AS120 Front Suspension 83000 Series	16-16874-000 16-16737-000 141700131810		83160	....	....	O	....	....
	MotorHomes with Freightliner XC Chassis Rear Shock with O.E.M. Number 85000 Series	141700131809 16-16736-000		....	....	....	O	85029	....
	MotorHomes with Freightliner XC Chassis ZF - IFS Front Suspension with 23,000 lb GVW or Greater 85000 Series	16-18103-000 481700000493		85900	....	....	O	....	....

### CROSS COUNTRY SE

03-05	MotorHomes with Freightliner XC Chassis ADL200 Suspension w/ 20K Rear 85000 Series	16-16873-000		....	....	O	85029	....	....
	MotorHomes with Freightliner XC Chassis AS120 Front Suspension 83000 Series	16-16874-000 16-16737-000 141700131810		83160	....	....	O	....	....
	MotorHomes with Freightliner XC Chassis Rear Shock with O.E.M. Number 85000 Series	141700131809 16-16736-000		....	....	....	O	85029	....
	MotorHomes with Freightliner XC Chassis ZF - IFS Front Suspension with 23,000 lb GVW or Greater 85000 Series	16-18103-000 481700000493		85900	....	....	O	....	....

### MIRADA

99-07	MotorHomes with Ford F53 Chassis with 16,000 lb GVW to 22,000 lb GVW 83000 Series	ASH-1229 ASH-1228 9U94-18045-AA ASH-1205 AT-620 ASH-1022 1C34-18045-AA ASH-294 9U9Z-18124-A ASH-25822 ASH-25823 1C34-18045-JA AT-766		83209	....	O	....	....	....	
		ASH-1206 9U94-18080-AA AT-621 ASH-25824 9U9Z-18125-A ASH-1023 ASH-1230 ASH-137		....	....	....	....	O	83122	....
	MotorHomes with Ford F53 Chassis with 16,000 lb GVW to 22,000 lb GVW 89000 Series	ASH-1229 ASH-1228 9U94-18045-AA ASH-1205 AT-620 ASH-1022 1C34-18045-AA ASH-294 9U9Z-18124-A ASH-25822 ASH-25823 1C34-18045-JA AT-766		....	89414	....	O	....	....	....
		ASH-1206 9U94-18080-AA AT-621 ASH-25824 9U9Z-18125-A ASH-1023 ASH-1230 ASH-137		....	....	....	....	O	89406	....

# APPLICATION GUIDE

Year	Fitment Notes	OEM#					
			Fleetline	GasSLX	Fleetline	GasSLX	Cab Shock Specialty Shock

## COACHMEN

## COACHMEN

### PURSUIT

04-12	MotorHomes with Ford F53 Chassis with 16,000 lb GVW to 22,000 lb GVW 83000 Series	ASH-1229 ASH-1228 9U94-18045-AA ASH-1205 AT-620 ASH-1022 1C34-18045-AA ASH-294 9U9Z-18124-A ASH-25822 ASH-25823 1C34-18045-JA AT-766	OO	83209	....				
		ASH-1206 9U94-18080-AA AT-621 ASH-25824 9U9Z-18125-A ASH-1023 ASH-1230 ASH-137	....	....	83122	....	....	OO	
	MotorHomes with Ford F53 Chassis with 16,000 lb GVW to 22,000 lb GVW 89000 Series	ASH-1229 ASH-1228 9U94-18045-AA ASH-1205 AT-620 ASH-1022 1C34-18045-AA ASH-294 9U9Z-18124-A ASH-25822 ASH-25823 1C34-18045-JA AT-766	OO	....	89414	....	....	....	....
		ASH-1206 9U94-18080-AA AT-621 ASH-25824 9U9Z-18125-A ASH-1023 ASH-1230 ASH-137	OO	....	....	....	89406	....	....

## CONTINENTAL TRAILWAYS-EAGLE INTL.

## CONTINENTAL TRAILWAYS-EAGLE INTL.

### VARIOUS

	Buses with O.E.M. Number 85000 Series	5532026	OO	85304	....				
		6-05-5 01-0100-020	OO	85307	....	....	....	....	....
	Silver Eagle 85000 Series	70039 680091 01-0100-905	OO	85303	....	....	....	....	....
		5394467 70041	OO	85305	....	....	....	....	....
Silver Eagle 89000 Series	70039 680091 01-0100-905	OO	....	89422	....	....	....	....	

## COUNTRY COACH

## COUNTRY COACH

### AFFINITY

00-10	MotorHomes with Gillig Chassis w/ Neway I-beam front		OT	85723	....				
	MotorHomes with Neway IFS		OO	85029	....	OO	83124	89407	....
	MotorHomes with Ridewell Front Suspension		OO	85712	....	....	....	....	....
	MotorHomes with Ridewell Rear Suspension		OO	....	....	OO	85734	....	....

### ALLURE

00-04	MotorHomes with Gillig Chassis w/ Neway I-beam front		OT	85723	....				
-------	--	--	----	-------	------	--	--	--	--

### CONCEPT

00	MotorHomes with Gillig Chassis w/ Neway I-beam front		OT	85723	....				
	MotorHomes with Neway IFS		OO	85029	....	OO	83124	89407	....
	MotorHomes with Ridewell Rear Suspension		OO	....	....	OO	85734	....	....

# APPLICATION GUIDE

Year	Fitment Notes	OEM#					
			Fleetline	GasSLX	Fleetline	GasSLX	Cab Shock Specialty Shock

## COUNTRY COACH

### CONCEPT (cont)

00	MotorHomes with Ridewell Suspension		O	85712	....							
----	-------------------------------------	--	---	-------	------	--	--	--	--	--	--	--

### INTRIGUE

00-04	MotorHomes with Gillig Chassis w/ Neway I-beam front		O	85723	....							
-------	--	--	---	-------	------	--	--	--	--	--	--	--

### MAGNA

00-04	MotorHomes with Gillig Chassis w/ Neway I-beam front		O	85723	....							
	MotorHomes with Neway IFS		O	85029	....	O	83124	89407				
	MotorHomes with Ridewell Rear Suspension		O	....	....		O	85734				
	MotorHomes with Ridewell Suspension		O	85712	....							

### MAGNA 630

05-10	MotorHomes with Gillig Chassis w/ Neway I-beam front		O	85723	....							
	MotorHomes with Neway IFS		O	85029	....	O	83124	89407				
	MotorHomes with Ridewell Rear Suspension		O	....	....		O	85734				
	MotorHomes with Ridewell Suspension		O	85712	....							

## CRANE CARRIER

### VARIOUS

	Models with Hendrickson HMX 400 Haulmax (with 16.5" Saddle) 83000 Series	60680-004L 60680-004 64178-001		....	....	O	83143					
	Models with Ridewell RDS-209 Tandem Air Drive Suspension Specialty Shock	1310002		....	....	O				665937		
	Models with Ridewell Truck Air-Ride Suspension with O.E.M. Number 85000 Series	1265157B000		....	....	O	85712					

## CRANE CARRIER

## CROWN COACH

	All with Steel Spring Suspension 85000 Series	3188729	O	85303	....							
		5532026	O	85304	....							
	All with Steel Spring Suspension 89000 Series	3188729	O	....	89422							
	Models with O.E.M. Number 85000 Series	5532036	O	85734	....							

## CROWN COACH

## CUNHA PRODUCTS OHD

	Truck Dollies 85000 Series	CP-5222		....	....	O	85315					
--	----------------------------	---------	--	------	------	---	-------	--	--	--	--	--

## CUNHA PRODUCTS OHD

## CUSH CORPORATION

### TRAILER SUSPENSIONS - LOW MOUNT

	25k UnderMount Econo 6/9 85000 Series	C0078		....	....	O	85000					
	25k UnderMount Econo 6/9 89000 Series	C0078		....	....	O		89436				
	CompacTrac 4.5/7 RH 85000 Series	C0078		....	....	O	85000					
	CompacTrac 4.5/7 RH 89000 Series	C0078		....	....	O		89436				
	CP Competitor Series (U-Bolted) 25K & 30K 85000 Series	C0226		....	....	O	85064					
	DiscMATE LowMount 25K Disc Brake 85000 Series	C0062-D		....	....	O	85000					
	DiscMATE LowMount 25K Disc Brake 89000 Series	C0062-D		....	....	O		89436				
	Performance Yoke-8in 25K Undermount 85000 Series	C0062-D		....	....	O	85000					
	Performance Yoke-8in 25K Undermount 89000 Series	C0062-D		....	....	O		89436				
	RideBest 25KHD 6 85000 Series	C0062-D		....	....	O	85000					
	RideBest 25KHD 6 89000 Series	C0062-D		....	....	O		89436				
	RideBest 25KHD 8 85000 Series	C0062-D		....	....	O	85000					

## CUSH CORPORATION

# APPLICATION GUIDE

Year	Fitment Notes	OEM#					
			Fleetline	GasSLX	Fleetline	GasSLX	Cab Shock Specialty Shock

## CUSH CORPORATION

## CUSH CORPORATION

### TRAILER SUSPENSIONS - LOW MOUNT (cont)

	RideBest 25KHD 8 89000 Series	C0062-D	....	....	OO	....	89436	....
	RideBest Yoke 25KHD 9 85000 Series	C0062-D	....	....	OO	85000	....	....
	RideBest Yoke 25KHD 9 89000 Series	C0062-D	....	....	OO	....	89436	....
	RoughNeck Series, Cush Integrated, LowMount 30k 85000 Series	C0226	....	....	OO	85064	....	....
	RoughNeck, Cush Integrated, LowMount 25K 85000 Series	C0062-D	....	....	OO	85000	....	....
	RoughNeck, Cush Integrated, LowMount 25K 89000 Series	C0062-D	....	....	OO	....	89436	....

### TRAILER SUSPENSIONS - TOP MOUNT

	CLT-25 CushLITE BigFOOT (245 Style) 85000 Series	C0078	....	....	OO	85000	....	....
	CLT-25 CushLITE BigFOOT (245 Style) 89000 Series	C0078	....	....	OO	....	89436	....
	CLX25-317 CushLITE BigFOOT (317 style) 85000 Series	C0078	....	....	OO	85000	....	....
	CLX25-317 CushLITE BigFOOT (317 style) 89000 Series	C0078	....	....	OO	....	89436	....
	CP Performance Top Mount 85000 Series	C0226	....	....	OO	85064	....	....
	CT250TB Top Mount High Travel (U-Bolted) 85000 Series	C0226	....	....	OO	85064	....	....
	DiscMATE 25K Roughneck Topmount 85000 Series	C0226	....	....	OO	85064	....	....
	RideBest 25K TopMount 85000 Series	C0226	....	....	OO	85064	....	....
	RideBest 25KHD TopMount 14-19 85000 Series	C0226	....	....	OO	85064	....	....
	RoughNeck Series, Cush Integrated, TopMount 25K 85000 Series	C04045	....	....	OO	85045	....	....
	RoughNeck Series, Cush Integrated, TopMount 30K 85000 Series	C0226	....	....	OO	85064	....	....

### VARIOUS

	Models with O.E.M. Number 85000 Series	C0228	....	....	OO	85005	....	....
		C0227	....	....	OO	85014	....	....
	Models with O.E.M. Number 89000 Series	C0228	....	....	OO	....	89430	....

## DAMON

## DAMON

### CHALLENGER

00-14	MotorHomes with Ford F53 Chassis with 16,000 lb GVW to 22,000 lb GVW	ASH-1229 ASH-1228 9U94-18045-AA ASH-1205 AT-620 ASH-1022 1C34-18045-AA ASH-294 9U9Z-18124-A ASH-25822 ASH-25823 1C34-18045-JA AT-766	83209	89414	OO	....	....	....
		ASH-1206 9U94-18080-AA AT-621 ASH-25824 9U9Z-18125-A ASH-1023 ASH-1230 ASH-137	....	....	OO	83122	89406	....

### CLASS A MOTORHOMES

04-11	Models with Workhorse W20 , W22, & W24 MotorHome Chassis with O.E.M. Number 85000 Series	W0005663 F4-BE5-F325-HO 24-153256	....	....	OO	85124	....	....
	Models with Workhorse W20 , W22, & W24 MotorHome Chassis with O.E.M. Number 98 - 11 85000 Series	24-153249 F4-BE5-B492-HO W0005662 W0006254 24153249 24-186629 F4-BE5-A832-MO F4-BE5-F324-HO	85125	....	OO	....	....	....

# APPLICATION GUIDE

Year	Fitment Notes	OEM#					
				Fleetline	GasSLX		Fleetline

## DAMON

## DAMON

### DAYBREAK

12-13	MotorHomes with Ford F53 Chassis with 16,000 lb GVW to 22,000 lb GVW 83000 Series	ASH-1229 ASH-1228 9U94-18045-AA ASH-1205 AT-620 ASH-1022 1C34-18045-AA ASH-294 9U9Z-18124-A ASH-25822 ASH-25823 1C34-18045-JA AT-766	OIO	83209	....	....	....	....
		ASH-1206 9U94-18080-AA AT-621 ASH-25824 9U9Z-18125-A ASH-1023 ASH-1230 ASH-137	....	....	OIO	83122	....	....
	MotorHomes with Ford F53 Chassis with 16,000 lb GVW to 22,000 lb GVW 89000 Series	ASH-1229 ASH-1228 9U94-18045-AA ASH-1205 AT-620 ASH-1022 1C34-18045-AA ASH-294 9U9Z-18124-A ASH-25822 ASH-25823 1C34-18045-JA AT-766	OIO	....	89414	....	....	....
		ASH-1206 9U94-18080-AA AT-621 ASH-25824 9U9Z-18125-A ASH-1023 ASH-1230 ASH-137	....	....	OIO	....	89406	....
00-11	MotorHomes with Ford F53 Chassis with 16,000 lb GVW to 22,000 lb GVW	ASH-1229 ASH-1228 9U94-18045-AA ASH-1205 AT-620 ASH-1022 1C34-18045-AA ASH-294 9U9Z-18124-A ASH-25822 ASH-25823 1C34-18045-JA AT-766	OIO	83209	89414	....	....	....
		ASH-1206 9U94-18080-AA AT-621 ASH-25824 9U9Z-18125-A ASH-1023 ASH-1230 ASH-137	....	....	OIO	83122	89406	....
99	MotorHomes with Ford F53 Chassis with 16,000 lb GVW to 22,000 lb GVW 83000 Series	ASH-1229 ASH-1228 9U94-18045-AA ASH-1205 AT-620 ASH-1022 1C34-18045-AA ASH-294 9U9Z-18124-A ASH-25822 ASH-25823 1C34-18045-JA AT-766	OIO	83209	....	....	....	....
		ASH-1206 9U94-18080-AA AT-621 ASH-25824 9U9Z-18125-A ASH-1023 ASH-1230 ASH-137	....	....	OIO	83122	....	....

# APPLICATION GUIDE

Year	Fitment Notes	OEM#					
			Fleetline	GasSLX	Fleetline	GasSLX	Cab Shock Specialty Shock

## DAMON

## DAMON

### DAYBREAK (cont)

99	MotorHomes with Ford F53 Chassis with 16,000 lb GVW to 22,000 lb GVW 89000 Series	ASH-1229 ASH-1228 9U94-18045-AA ASH-1205 AT-620 ASH-1022 1C34-18045-AA ASH-294 9U9Z-18124-A ASH-25822 ASH-25823 1C34-18045-JA AT-766	O/O	....	89414	....	....	....
		ASH-1206 9U94-18080-AA AT-621 ASH-25824 9U9Z-18125-A ASH-1023 ASH-1230 ASH-137	....	....	O/O	....	89406	....

### INTRUDER

00-07	MotorHomes with Ford F53 Chassis with 16,000 lb GVW to 22,000 lb GVW	ASH-1229 ASH-1228 9U94-18045-AA ASH-1205 AT-620 ASH-1022 1C34-18045-AA ASH-294 9U9Z-18124-A ASH-25822 ASH-25823 1C34-18045-JA AT-766	O/O	83209	89414	....	....	....	
		ASH-1206 9U94-18080-AA AT-621 ASH-25824 9U9Z-18125-A ASH-1023 ASH-1230 ASH-137	....	....	O/O	83122	89406	....	....
99	MotorHomes with Ford F53 Chassis with 16,000 lb GVW to 22,000 lb GVW 83000 Series	ASH-1229 ASH-1228 9U94-18045-AA ASH-1205 AT-620 ASH-1022 1C34-18045-AA ASH-294 9U9Z-18124-A ASH-25822 ASH-25823 1C34-18045-JA AT-766	O/O	83209	....	....	....	....	
		ASH-1206 9U94-18080-AA AT-621 ASH-25824 9U9Z-18125-A ASH-1023 ASH-1230 ASH-137	....	....	O/O	83122	....	....	....
		ASH-1229 ASH-1228 9U94-18045-AA ASH-1205 AT-620 ASH-1022 1C34-18045-AA ASH-294 9U9Z-18124-A ASH-25822 ASH-25823 1C34-18045-JA AT-766	O/O	....	89414	....	....	....	....
	ASH-1206 9U94-18080-AA AT-621 ASH-25824 9U9Z-18125-A ASH-1023 ASH-1230 ASH-137	....	....	O/O	....	89406	....	....	



# APPLICATION GUIDE

Year	Fitment Notes	OEM#					
			Fleetline	GasSLX	Fleetline	GasSLX	Cab Shock\ Specialty Shock

## DAMON

## DAMON

### OUTLAW

12-14	MotorHomes with Ford F53 Chassis with 16,000 lb GVW to 22,000 lb GVW 83000 Series	ASH-1229 ASH-1228 9U94-18045-AA ASH-1205 AT-620 ASH-1022 1C34-18045-AA ASH-294 9U9Z-18124-A ASH-25822 ASH-25823 1C34-18045-JA AT-766	OIO	83209	....	....	....	....
		ASH-1206 9U94-18080-AA AT-621 ASH-25824 9U9Z-18125-A ASH-1023 ASH-1230 ASH-137	....	....	83122	....	....	....
	MotorHomes with Ford F53 Chassis with 16,000 lb GVW to 22,000 lb GVW 89000 Series	ASH-1229 ASH-1228 9U94-18045-AA ASH-1205 AT-620 ASH-1022 1C34-18045-AA ASH-294 9U9Z-18124-A ASH-25822 ASH-25823 1C34-18045-JA AT-766	OIO	....	89414	....	....	....
		ASH-1206 9U94-18080-AA AT-621 ASH-25824 9U9Z-18125-A ASH-1023 ASH-1230 ASH-137	....	....	....	89406	....	....
07-11	MotorHomes with Ford F53 Chassis with 16,000 lb GVW to 22,000 lb GVW	ASH-1229 ASH-1228 9U94-18045-AA ASH-1205 AT-620 ASH-1022 1C34-18045-AA ASH-294 9U9Z-18124-A ASH-25822 ASH-25823 1C34-18045-JA AT-766	OIO	83209	89414	....	....	....
		ASH-1206 9U94-18080-AA AT-621 ASH-25824 9U9Z-18125-A ASH-1023 ASH-1230 ASH-137	....	....	83122	89406	....	....

## DANA

## DANA

### VARIOUS

	Dana Smart Ride - RF and RS Models - 20,000 lb and 23,000 lb 85000 Series	SR1VJ100	....	....	OIO	85078	....	....
--	---	----------	------	------	-----	-------	------	------

## DENNIS EAGLE

## DENNIS EAGLE

### PROVIEW

21-23	Models with Hendrickson HN-460 Rear Suspension	60680-003L 60680-003	....	....	OIO	83112	....	....
17	Models with Hendrickson HN-460 Rear Suspension	60680-003L 60680-003	....	....	OIO	83112	....	....

## DEXTER AXLE

## DEXTER AXLE

### TRAILER

	86 AR / RS 1015, 1035, 3015, 3035 Slider Air Suspension 85000 Series	18165-01	....	....	OIO	85006	....	....
--	--	----------	------	------	-----	-------	------	------

# APPLICATION GUIDE

Year	Fitment Notes	OEM#					
			Fleetline	GasSLX	Fleetline	GasSLX	Cab Shock/ Specialty Shock

## DIAMOND REO VARIOUS

## DIAMOND REO

	Additional O.E.M. Interchanges 85000 Series	220-S5-10	....	....	○	85712	....	....
	All w/Velvet Ride Suspension 85000 Series	.....	....	....	○	85307	....	....
	C054, C088 w/FH or FL Axle 85000 Series	.....	○	○	○	85307	....	....
	C054, C088, C114, C116 w/FF Axle 83000 Series	220-55-6 220-55-1	○	○	○	83214	....	....
	C090, C090D, C101 85000 Series	220-55-7 220-55-2	○	○	○	85304	....	....
	C114, C116 w/FH or FL Axle 85000 Series	220-55-7 220-55-2	○	○	○	85304	....	....
	DC101 85000 Series	220-55-7 220-55-2	○	○	○	85304	....	....

## DIAMOND T

## DIAMOND T

	Models with O.E.M. Number 85000 Series	5549925	○	○	○	85304	....	....
--	--	---------	---	---	---	-------	------	------

## DUPLEX

## DUPLEX

	Models with O.E.M. Number 83000 Series	7604-3371 59024	○	○	○	83204	....	....
--	--	--------------------	---	---	---	-------	------	------

## DURA SUSPENSION

## DURA SUSPENSION

	Models with O.E.M. Number 83000 Series	665133 1080099 59030	....	....	○	83203	....	....
		7604-3371 59024	....	....	○	83204	....	....
		12866	....	....	○	83207	....	....
	Models with O.E.M. Number 85000 Series	A-2212	....	....	○	85029	....	....
	Models with O.E.M. Number 89000 Series	12866	....	....	○	89407	....	....
		665133 1080099 59030	....	....	○	89436	....	....

## DYNAMAX CORP

## DYNAMAX CORP

### DX3

13-24	Models with 8000 to 16000 lb Front Axle and Taperleaf Spring	10-13760-000 471700002991 SDA471700002991	○	○	○	85959	....	....
	Models with Airliner 21,000 lb Rear Air Suspension	16-15817-000 16-18708-000 481700006848 471700002809 SDA471700002809	....	....	○	85724	89443	....

### DYNAQUEST

05-07	Models with 10000 to 12000 lb. Taper-leaf Spring Suspension	10-12390-000	○	○	○	85920	89503	....
	Models with Airliner 18,000 lb Rear Air Suspension	16-15817-000 16-18708-000 481700006848 471700002809 SDA471700002809	....	....	○	85724	89443	....

### DYNAQUEST ST

09-14	Models with 8000 to 16000 lb Front Axle and Taperleaf Spring	10-13760-000 471700002991 SDA471700002991	○	○	○	85959	....	....
	Models with Airliner 18,000 lb Rear Air Suspension	16-15817-000 16-18708-000 481700006848 471700002809 SDA471700002809	....	....	○	85724	89443	....

### DYNAQUEST XL

09-24	Models with 12000 lb to 20000 Front Axle	10-13809-000 471700003920	○	○	○	85958	....	....
-------	--	------------------------------	---	---	---	-------	------	------

# APPLICATION GUIDE

Year	Fitment Notes	OEM#					
			Fleetline	GasSLX	Fleetline	GasSLX	Cab Shock Specialty Shock

## DYNAMAX CORP

## DYNAMAX CORP

### DYNAQUEST XL (cont)

09-24	Models with FAS II (40,000 lb) Rear Air Suspension	16-15817-000 16-18708-000 481700006848 471700002809 SDA471700002809	...	...	OIO	85724	89443	...
-------	--	---	-----	-----	-----	-------	-------	-----

### EUROPA

21-24	Models with 8000 to 16000 lb Front Axle and Taperleaf Spring	10-13760-000 471700002991 SDA471700002991	OIO	85959	...	...	...	...
	Models with Airliner 21,000 lb Rear Air Suspension	16-15817-000 16-18708-000 481700006848 471700002809 SDA471700002809	...	...	OIO	85724	89443	...

### FORCE HD

22	Models with 8000 to 16000 lb Front Axle and Taperleaf Spring	10-13760-000 471700002991 SDA471700002991	OIO	85959	...	...	...	...
	Models with Airliner 21,000 lb Rear Air Suspension	16-15817-000 16-18708-000 481700006848 471700002809 SDA471700002809	...	...	OIO	85724	89443	...
19-21	Models with 8000 to 16000 lb Front Axle and Taperleaf Spring 85000 Series	10-13760-000 471700002991 SDA471700002991	OIO	85959	...	...	...	...
15-18	Models with 8000 to 16000 lb Front Axle and Taperleaf Spring	10-13760-000 471700002991 SDA471700002991	OIO	85959	...	...	...	...
	Models with Airliner 21,000 lb Rear Air Suspension	16-15817-000 16-18708-000 481700006848 471700002809 SDA471700002809	...	...	OIO	85724	89443	...

### GRAND SPORT

02-04	Models 23,000 lb Airliner Rear Air Suspension	16-15817-000 471700002808 16-18708-000 481700006848 471700002809 SDA471700002809	...	...	OIO	85724	89443	...
	Models with 12000 lb Taperleaf Front Suspension	10-13634-000 47170000449 10-13063-000 10-13021-000 10-13684-000 10-13211-000 471700131155	OIO	85918	89449	...	...	...

### GRAND SPORT GT

09-14	Models with 14,600 lb Taperleaf Front Suspension	SDA471700003920 10-13809-000	OIO	85958	...	...	...	...
	Models with Freightliner Airliner Rear Air Suspension	16-15817-000 16-18708-000 481700006848 471700002809 SDA471700002809	...	...	OIO	85724	89443	...

### GRAND SPORT GT TOY HAULER

09-13	390TH Models with 12000 lb Taperleaf Front Suspension	10-13760-000 471700002991 SDA471700002991	OIO	85959	...	...	...	...
	410TH & 450TH Models with 12000 lb Taperleaf Front Suspension	SDA471700003920 10-13809-000	OIO	85958	...	...	...	...
07-13	Models 21K or 23K Airliner Rear Air Suspension	16-15817-000 471700002808 16-18708-000 481700006848 471700002809 SDA471700002809	...	...	OIO	85724	89443	...
07-08	390TH Models with 12000 lb Taperleaf Front Suspension	10-12390-000	OIO	85920	89503	...	...	...

# APPLICATION GUIDE

Year	Fitment Notes	OEM#					
			Fleetline	GasSLX	Fleetline	GasSLX	Cab Shock Specialty Shock

## DYNAMAX CORP

## DYNAMAX CORP

### GRAND SPORT GT TOY HAULER (cont)

07-08	410TH & 450TH Models with 12000 lb Taperleaf Front Suspension	10-13634-000 471700000449 10-13063-000 10-13021-000 10-13684-000 10-13211-000 471700131155	O/O	85918	89449	....	....	....
-------	---	--	-----	-------	-------	------	------	------

### GRAND SPORT M2

03-07	Models with 10000 to 12000 lb. Taper-leaf Spring Suspension	10-12390-000	O/O	85920	89503	....	....	....
	Models with Airliner 21,000 lb Rear Air Suspension	16-15817-000 16-18708-000 481700006848 471700002809 SDA471700002809	O/O	....	....	85724	89443	....

### GRAND SPORT ULTRA

09-14	Models with 14,000 lb Taperleaf Front Suspension	SDA471700003920 10-13809-000	O/O	85958	....	....	....	....
07-14	Models 23,000 lb Airliner Rear Air Suspension	16-15817-000 471700002808 16-18708-000 481700006848 471700002809 SDA471700002809	O/O	....	....	85724	89443	....
	07-08	Models with 14,000 lb Taperleaf Front Suspension	O/O	85918	89449	....	....	....

## EAGLE MOTOR COACH

## EAGLE MOTOR COACH

### VARIOUS

	Buses with Rubber Torsion Suspension 85000 Series	6-05-5	O/O	....	....	85307	....	....
	Buses with Steel Spring Suspension 85000 Series	5532026	O/O	85304	....	....	....	....
	Models with O.E.M. Number 85000 Series	70039 680091 01-0100-905	O/O	85303	....	....	....	....
		5394467 101364 70041	O/O	85305	....	....	....	....
		01-0100-020	O/O	85307	....	....	....	....
		014-0100-905	O/O	85308	....	....	....	....
		154-0100-514	O/O	85314	....	....	....	....
		690060	O/O	....	....	85713	....	....
		12J-5-10	O/O	....	....	85733	....	....
	Models with O.E.M. Number 89000 Series	70039 680091 01-0100-905 014-0100-905	O/O	....	89422	....	....	....
154-0100-514		O/O	....	89425	....	....	....	

## EAST MANUFACTURING CORP.

## EAST MANUFACTURING CORP.

	Shocks with stamping number 85000 Series	A-20002	O/O	....	....	85000	....	....
		A-20126	O/O	....	....	85323	....	....
	Shocks with stamping number 89000 Series	A-20126 A-20002	O/O	....	....	....	89436	....
		Trailers with East Trailer part number 83000 Series	517-05916-14	O/O	....	....	83124	....
		517-05009-14	O/O	....	....	83125	....	....
		517-05511-14	O/O	....	....	83128	....	....
		517-05010-07	O/O	....	....	83214	....	....

# APPLICATION GUIDE

Year	Fitment Notes	OEM#					
			Fleetline	GasSLX	Fleetline	GasSLX	Cab Shock Specialty Shock

## EAST MANUFACTURING CORP. VARIOUS (cont)

## EAST MANUFACTURING CORP.

	Trailers with East Trailer part number 85000 Series	517-05110-20	...	...	85000	...	...	
		517-05805-20	...	...	85005	...	...	
		517-05001-23	...	...	85029	...	...	
		517-05806-20	...	...	85030	...	...	
		517-05006-20	...	...	85738	...	...	
	Trailers with East Trailer part number 87000 Series	517-05001-18	...	...	87015	...	...	
		Trailers with East Trailer part number 89000 Series		517-05916-14	...	...	89407	...
	517-05001-23			...	...	89430	...	
	517-05110-20 517-05511-14 517-05805-20			...	...	89436	...	...
	517-05809-20			...	...	89437	...	...
	517-05006-20			...	...	89440	...	...

## EMERGENCY ONE

## EMERGENCY ONE

	AERM Models with 10K Front Leaf Spring 85000 Series	90-2572	85329	...	...	...	...
	AERM Models with 21K Front Taper-Leaf Spring 85000 Series	90-2572	85329	...	...	...	...
	PAEM Models with 19K Front Taper-Leaf Spring 85000 Series	90-2572	85329	...	...	...	...
	PMPR Models with 19K Front Taper-Leaf Spring 85000 Series	90-2572	85329	...	...	...	...

## ENTEGRA COACH

## ENTEGRA COACH

### ACCOLADE

20-24	Models with Freightliner S2RV chassis	10-13976-000	85918	89449	...	...	...
		16-16764-000	...	...	85724	89443	...

### ACCOLADE XL

21-24	Models with Freightliner S2RV chassis	10-13976-000	85918	89449	...	...	...
		16-16764-000	...	...	85724	89443	...

### EMBLEM

19-24	MotorHomes with Ford F53 Chassis with 16,000 lb GVW to 22,000 lb GVW	ASH-25822 ASH-25823	83209	89414	...	...	...
		ASH-1206 9U94-18080-AA AT-621 ASH-25824 9U9Z-18125-A ASH-1023 ASH-1230 ASH-137	...	...	83122	89406	...
	MotorHomes with Ford F53 Chassis with 24,000 lb GVW to 26,000 lb GVW	ASH-25821 ASH-1161	85006	...	...	...	...
19-23	MotorHomes with Ford F53 Chassis with 24,000 lb GVW to 26,000 lb GVW	ASH-25820 ASH-1162	...	...	85005	89430	...

### VISION

19-24	MotorHomes with Ford F53 Chassis with 16,000 lb GVW to 22,000 lb GVW	ASH-25822 ASH-25823	83209	89414	...	...	...
		ASH-1206 9U94-18080-AA AT-621 ASH-25824 9U9Z-18125-A ASH-1023 ASH-1230 ASH-137	...	...	83122	89406	...

### VISION XL

20-24	MotorHomes with Ford F53 Chassis with 24,000 lb GVW to 26,000 lb GVW	ASH-25821 ASH-1161	85006	...	...	...	...
-------	--	-----------------------	-------	-----	-----	-----	-----

# APPLICATION GUIDE

Year	Fitment Notes	OEM#					
			Fleetline	GasSLX	Fleetline	GasSLX	Cab Shock Specialty Shock

## ENTEGRA COACH

### VISION XL (cont)

## ENTEGRA COACH

20-23	MotorHomes with Ford F53 Chassis with 24,000 lb GVW to 26,000 lb GVW	ASH-25820 ASH-1162	....	....	☉	85005	89430	....
-------	--	-----------------------	------	------	---	-------	-------	------

## FEDERAL COACH

### VARIOUS

## FEDERAL COACH

09-19	Shuttle buses with Freightliner M2-106 Chassis 85000 Series	10-13760-000 471700002991 SDA471700002991	☉	85959	....	....	....	....
02-19	Shuttle buses with Freightliner M2-106 Chassis 85000 Series	16-18708-000 471700002809	☉	....	....	☉	85724	....
	Shuttle buses with Freightliner M2-106 Chassis 89000 Series	16-18708-000 471700002809	☉	....	....	☉	....	89443
02-08	Shuttle buses with Freightliner M2-106 Chassis 85000 Series	10-12388-000 10-12390-000	☉	85920	....	....	....	....
	Shuttle buses with Freightliner M2-106 Chassis 89000 Series	10-12388-000 10-12390-000	☉	....	89503	....	....	....

## FLEETWOOD

### AXON

## FLEETWOOD

19-20	MotorHomes with Ford F53 Chassis with 16,000 lb GVW to 22,000 lb GVW 83000 Series	ASH-1229 ASH-1228 9U94-18045-AA ASH-1205 AT-620 ASH-1022 1C34-18045-AA ASH-294 9U9Z-18124-A ASH-25822 ASH-25823 1C34-18045-JA AT-766	☉	83209	....	....	....	....
		ASH-1206 9U94-18080-AA AT-621 ASH-25824 9U9Z-18125-A ASH-1023 ASH-1230 ASH-137	☉	....	....	☉	83122	....
	MotorHomes with Ford F53 Chassis with 16,000 lb GVW to 22,000 lb GVW 89000 Series	ASH-1229 ASH-1228 9U94-18045-AA ASH-1205 AT-620 ASH-1022 1C34-18045-AA ASH-294 9U9Z-18124-A ASH-25822 ASH-25823 1C34-18045-JA AT-766	☉	....	89414	....	....	....
18	MotorHomes with Ford F53 Chassis with 16,000 lb GVW to 22,000 lb GVW	ASH-1206 9U94-18080-AA AT-621 ASH-25824 9U9Z-18125-A ASH-1023 ASH-1230 ASH-137	☉	....	....	☉	....	89406
		ASH-1229 ASH-1228 9U94-18045-AA ASH-1205 AT-620 ASH-1022 1C34-18045-AA ASH-294 9U9Z-18124-A ASH-25822 ASH-25823 1C34-18045-JA AT-766	☉	83209	89414	....	....	....

# APPLICATION GUIDE

Year	Fitment Notes	OEM#					
			Fleetline	GasSLX	Fleetline	GasSLX	Cab Shock\ Specialty Shock

## FLEETWOOD

### AXON (cont)

18	MotorHomes with Ford F53 Chassis with 16,000 lb GVW to 22,000 lb GVW	ASH-1206 9U94-18080-AA AT-621 ASH-25824 9U9Z-18125-A ASH-1023 ASH-1230 ASH-137	OIO	85006	....	83122	89406	....
----	--	---	-----	-------	------	-------	-------	------

## FLEETWOOD

### BOUNDER

08-24	MotorHomes with Ford F53 Chassis with 24,000 lb GVW to 26,000 lb GVW	ASH-25821 ASH-1161	OIO	85006	....	....	....	....
00-24	MotorHomes with Ford F53 Chassis with 16,000 lb GVW to 22,000 lb GVW	ASH-1229 ASH-1228 9U94-18045-AA ASH-1205 AT-620 ASH-1022 1C34-18045-AA ASH-294 9U9Z-18124-A ASH-25822 ASH-25823 1C34-18045-JA AT-766	OIO	83209	89414	....	....	....
		ASH-1206 9U94-18080-AA AT-621 ASH-25824 9U9Z-18125-A ASH-1023 ASH-1230 ASH-137	....	....	83122	89406	....	
08-23	MotorHomes with Ford F53 Chassis with 24,000 lb GVW to 26,000 lb GVW	ASH-25820 ASH-1162	OIO	....	....	85005	89430	....
02-06	Models with Freightliner XC Chassis with ZF - IFS Front Suspension and 23,000 lb GVW or Greater	16-18103-000 481700000493	IT	85900	....	....	....	....
	MotorHomes with Freightliner XC Chassis and ADL200 Suspension w/ 20K Rear	16-16873-000 141700131809 16-16736-000	OIO	....	....	85029	....	....
	MotorHomes with Freightliner XC Chassis and AS120 Front Suspension	16-16874-000 16-16737-000 141700131810	OIO	83160	....	....	....	....

### CLASS A MOTORHOMES

04-11	Models with Workhorse W20 , W22, & W24 MotorHome Chassis with O.E.M. Number 85000 Series	W0005663 F4-BE5-F325-HO 24-153256	IT	....	....	85124	....	....
-------	--	---	----	------	------	-------	------	------

### DISCOVERY

02-06	Models with Freightliner XC Chassis with ZF - IFS Front Suspension and 23,000 lb GVW or Greater	16-18103-000 481700000493	IT	85900	....	....	....	....
	MotorHomes with Freightliner XC Chassis and ADL200 Suspension w/ 20K Rear	16-16873-000 141700131809 16-16736-000	OIO	....	....	85029	....	....
	MotorHomes with Freightliner XC Chassis and AS120 Front Suspension	16-16874-000 16-16737-000 141700131810	OIO	83160	....	....	....	....

### EXCURSION

03-06	Models with Freightliner XC Chassis with ZF - IFS Front Suspension and 23,000 lb GVW or Greater	16-18103-000 481700000493	IT	85900	....	....	....	....
02-06	MotorHomes with Freightliner XC Chassis and ADL200 Suspension w/ 20K Rear	16-16873-000 141700131809 16-16736-000	OIO	....	....	85029	....	....
	MotorHomes with Freightliner XC Chassis and AS120 Front Suspension	16-16874-000 16-16737-000 141700131810	OIO	83160	....	....	....	....

### EXPEDITION

02-06	Models with Freightliner XC Chassis with ZF - IFS Front Suspension and 23,000 lb GVW or Greater	16-18103-000 481700000493	IT	85900	....	....	....	....
	MotorHomes with Freightliner XC Chassis and AS120 Front Suspension	16-16874-000 16-16737-000 141700131810	OIO	83160	....	....	....	....



# APPLICATION GUIDE

Year	Fitment Notes	OEM#					
				Fleetline	GasSLX		Fleetline

## FLEETWOOD FLAIR

## FLEETWOOD

15-24	MotorHomes with Ford F53 Chassis with 16,000 lb GVW to 22,000 lb GVW	ASH-1229 ASH-1228 9U94-18045-AA ASH-1205 AT-620 ASH-1022 1C34-18045-AA ASH-294 9U9Z-18124-A ASH-25822 ASH-25823 1C34-18045-JA AT-766	OO	83209	89414	....	....	....
		ASH-1206 9U94-18080-AA AT-621 ASH-25824 9U9Z-18125-A ASH-1023 ASH-1230 ASH-137	OO	....	....	83122	89406	....
00-07	MotorHomes with Ford F53 Chassis with 16,000 lb GVW to 22,000 lb GVW	ASH-1229 ASH-1228 9U94-18045-AA ASH-1205 AT-620 ASH-1022 1C34-18045-AA ASH-294 9U9Z-18124-A ASH-25822 ASH-25823 1C34-18045-JA AT-766	OO	83209	89414	....	....	....
		ASH-1206 9U94-18080-AA AT-621 ASH-25824 9U9Z-18125-A ASH-1023 ASH-1230 ASH-137	OO	....	....	83122	89406	....

## FLEX

23-24	MotorHomes with Ford F53 Chassis with 16,000 lb GVW to 22,000 lb GVW	ASH-1229 ASH-1228 9U94-18045-AA ASH-1205 AT-620 ASH-1022 1C34-18045-AA ASH-294 9U9Z-18124-A ASH-25822 ASH-25823 1C34-18045-JA AT-766	OO	83209	89414	....	....	....
		ASH-1206 9U94-18080-AA AT-621 ASH-25824 9U9Z-18125-A ASH-1023 ASH-1230 ASH-137	OO	....	....	83122	89406	....

## FORTIS

20-24	MotorHomes with Ford F53 Chassis with 16,000 lb GVW to 22,000 lb GVW	ASH-1229 ASH-1228 9U94-18045-AA ASH-1205 AT-620 ASH-1022 1C34-18045-AA ASH-294 9U9Z-18124-A ASH-25822 ASH-25823 1C34-18045-JA AT-766	OO	83209	89414	....	....	....
-------	--	--	----	-------	-------	------	------	------

# APPLICATION GUIDE

Year	Fitment Notes	OEM#					
			Fleetline	GasSLX	Fleetline	GasSLX	Cab Shock\ Specialty Shock

## FLEETWOOD

## FLEETWOOD

### FORTIS (cont)

20-24	MotorHomes with Ford F53 Chassis with 16,000 lb GVW to 22,000 lb GVW	ASH-1206 9U94-18080-AA AT-621 ASH-25824 9U9Z-18125-A ASH-1023 ASH-1230 ASH-137	O/O	85006	....	O/O	83122	89406	....
	MotorHomes with Ford F53 Chassis with 24,000 lb GVW to 26,000 lb GVW	ASH-25821 ASH-1161	O/O	85006	....	O/O	....	....	....
20-23	MotorHomes with Ford F53 Chassis with 24,000 lb GVW to 26,000 lb GVW	ASH-25820 ASH-1162	O/O	....	....	O/O	85005	89430	....

### PROVIDENCE

04-06	Models with Freightliner XC Chassis with ZF - IFS Front Suspension and 23,000 lb GVW or Greater	16-18103-000 481700000493	I/I	85900	....	O/O	....	....	....
	MotorHomes with Freightliner XC Chassis and ADL200 Suspension w/ 20K Rear	16-16873-000 141700131809 16-16736-000	O/O	....	....	O/O	85029	....	....
	MotorHomes with Freightliner XC Chassis and AS120 Front Suspension	16-16874-000 16-16737-000 141700131810	O/O	83160	....	O/O	....	....	....



### SOUTHWIND

08-23	MotorHomes with Ford F53 Chassis with 24,000 lb GVW to 26,000 lb GVW	ASH-25821 ASH-1161	O/O	85006	....	O/O	....	....	....
		ASH-25820 ASH-1162	O/O	....	....	O/O	85005	89430	....
00-23	MotorHomes with Ford F53 Chassis with 16,000 lb GVW to 22,000 lb GVW	ASH-1229 ASH-1228 9U94-18045-AA ASH-1205 AT-620 ASH-1022 1C34-18045-AA ASH-294 9U9Z-18124-A ASH-25822 ASH-25823 1C34-18045-JA AT-766	O/O	83209	89414	O/O	....	....	....
		ASH-1206 9U94-18080-AA AT-621 ASH-25824 9U9Z-18125-A ASH-1023 ASH-1230 ASH-137	O/O	....	....	O/O	83122	89406	....

### STORM

11-18	MotorHomes with Ford F53 Chassis with 16,000 lb GVW to 22,000 lb GVW	ASH-1229 ASH-1228 9U94-18045-AA ASH-1205 AT-620 ASH-1022 1C34-18045-AA ASH-294 9U9Z-18124-A ASH-25822 ASH-25823 1C34-18045-JA AT-766	O/O	83209	89414	O/O	....	....	....
		ASH-1206 9U94-18080-AA AT-621 ASH-25824 9U9Z-18125-A ASH-1023 ASH-1230 ASH-137	O/O	....	....	O/O	83122	89406	....

# APPLICATION GUIDE

Year	Fitment Notes	OEM#					
			Fleetline	GasSLX	Fleetline	GasSLX	Cab Shock Specialty Shock

## FLEETWOOD

## FLEETWOOD

### STORM (cont)

01-07	MotorHomes with Ford F53 Chassis with 16,000 lb GVW to 22,000 lb GVW	ASH-1229 ASH-1228 9U94-18045-AA ASH-1205 AT-620 ASH-1022 1C34-18045-AA ASH-294 9U9Z-18124-A ASH-25822 ASH-25823 1C34-18045-JA AT-766	83209	89414	...	...	...
		ASH-1206 9U94-18080-AA AT-621 ASH-25824 9U9Z-18125-A ASH-1023 ASH-1230 ASH-137			...	...	83122

## FLUIDRIVE

## FLUIDRIVE

### VARIOUS

	Models T950-1200, -1400, -1700 85000 Series	2697	...	...	85712	...	...
--	---	------	-----	-----	-------	-----	-----

## FLXIBLE TRANSIT BUS

## FLXIBLE TRANSIT BUS

	2-Level Intercity Bus 85000 Series	....	85736	....	....	....	....	
	City Bus - 51 Passenger 85000 Series	6-05-5	85307	....	....	....	....	
		6-05-7 6-05-8 6-05-6 6-05-3 6-05-4 6-05-1 6-05-2	85736	....	....	....	....	
		City Bus - 51 Passenger with Rubber Torsion Suspension 85000 Series	6-05-1	85736	....	....	....	....
			6-05-5	....	....	85307	....	....
			6-05-7 6-05-8 6-05-6 6-05-3 6-05-4 6-05-2	....	....	85736	....	....
			Model 870 Flex Bus, Metro 85000 Series	87-2520-00003 4975518 97-2210-00009 87-2520-00001 74412 97-2210-00011 97-2210-00002 97-2210-00001 97-2210-00004 97-2210-00003 97-2210-00006 97-2210-00005	....	....	85704	....

## FLYER INDUSTRIES

## FLYER INDUSTRIES

	Coaches with Low Floor 85000 Series	15813	....	....	85708	....	....
91-21	Coaches with Low Floor 85000 Series	009863	85722	....	....	....	....

## FORD

## FORD

### 8500 SERIES

	Models with 101", 113" & 122" BBC Conventional Tractors with Link Cabmate Models FH101, FH1322 & FH1322-A 83000 Series	1201-1043 1202-1043	....	....	....	....	83025
--	--	------------------------	------	------	------	------	-------

### 9500 SERIES

	Models with 101", 113" & 122" BBC Conventional Tractors with Link Cabmate Models FH101, FH1322 & FH1322-A 83000 Series	1201-1043 1202-1043	....	....	....	....	83025
	Models with O.E.M. Number 83000 Series	F6HZ-5K407-AB	....	....	....	....	83034

# APPLICATION GUIDE

Year	Fitment Notes	OEM#					
			Fleetline	GasSLX	Fleetline	GasSLX	Cab Shock\ Specialty Shock

## FORD

## FORD

### A9513

96-98	All Models with 10000 lb or 12000 lb Axle and 54" Taperleaf Spring	F6HT-18045-AC F6HZ-18124-A F6HZ-18124-G	OIO	85054	....	....	....	....
	All with 12000 lb, 13000 lb or 14600 lb Axle and 60" Taperleaf Spring	F6HT-18045-EB F6HT-18045-EC F6HZ-18124-F F6HZ-18124-E F6HZ-18124-D	OIO	85055	89439	....	....	....
	All with 13200 lb or 14600 lb Axle and 54" Taperleaf Spring	F6HT-18045-GC F6HT-18045-GB	OIO	85030	89440	....	....	....
	All with 23000 lb Axle and 52" Taperleaf spring	F5HZ-18125-A	OIO	....	....	85314	89425	....
	All with Hendrickson HAS-400, HA-210 or HA-230 Air Suspension	F6HZ-18080-FC 47902-28 F6HZ-18125-D	OIO	....	....	85013	89414	....
	All with Neway AD-246 Air Suspension	90045099 90045132	OIO	....	....	85906	89407	....
	Models with 10000 lb Axle and 54" Multileaf Spring	F6HT-18045-KA	OIO	....	89402	....	....	....
	Models with 12000 or 13200 lb Axle and 54" Multileaf Spring	F6HT-18045-BC	OIO	85047	89435	....	....	....
	Models with 21000 lb or 23000 lb Axle and 46" Taperleaf spring	F5HZ-18125-B	OIO	....	....	85001	89410	....
	Models with 8500 or 9000 lb Axle and 54" Taperleaf Spring	F6HT-18045-HC	OIO	85054	....	....	....	....
	Models with Hendrickson 40LH Model Tandem Axle	F6HT-18080-DA F6HZ-18125-B F6HT-18080-B 57241-2	OIO	....	....	83109	....	....

### A9522

97	All Models with 10000 lb or 12000 lb Axle and 54" Taperleaf Spring	F6HT-18045-AC F6HZ-18124-A F6HZ-18124-G	OIO	85054	....	....	....	....
	All with 12000 lb, 13000 lb or 14600 lb Axle and 60" Taperleaf Spring	F6HT-18045-EB F6HT-18045-EC F6HZ-18124-F F6HZ-18124-E F6HZ-18124-D	OIO	85055	89439	....	....	....
	All with 13200 lb or 14600 lb Axle and 54" Taperleaf Spring	F6HT-18045-GC F6HT-18045-GB	OIO	85030	89440	....	....	....
	All with 23000 lb Axle and 52" Taperleaf spring	F5HZ-18125-A	OIO	....	....	85314	89425	....
	All with Hendrickson HAS-400, HA-210 or HA-230 Air Suspension	F6HZ-18080-FC 47902-28 F6HZ-18125-D	OIO	....	....	85013	89414	....
	All with Neway AD-246 Air Suspension	90045099 90045132	OIO	....	....	85906	89407	....
	Models with 12000 or 13200 lb Axle and 54" Multileaf Spring	F6HT-18045-BC	OIO	85047	89435	....	....	....
	Models with 21000 lb or 23000 lb Axle and 46" Taperleaf spring	F5HZ-18125-B	OIO	....	....	85001	89410	....
	Models with 8500 or 9000 lb Axle and 54" Taperleaf Spring	F6HT-18045-HC	OIO	85054	....	....	....	....
	Models with Hendrickson 40LH Model Tandem Axle	F6HT-18080-DA F6HZ-18125-B F6HT-18080-B 57241-2	OIO	....	....	83109	....	....

### ADDITIONAL APPLICATIONS

CL9000 & CLT9000 Cabover Tractors (Sleeper & Non-Sleeper) with Link Cabmate Model FCL110-2P 83000 Series	1202-0032	OIO	....	....	....	....	83016
Models with Link Cab Suspension 83000 Series	1202-0042	OIO	....	....	....	....	83025

### AEROMAX (A, AT, AAT, 8500, 9500) SERIES

96	8000 Models with 12000 or 13000 lb Axles 85000 Series	F6HT-18045-LA	OIO	85376	....	....	....
	8000 Models with 16000 lb. Multileaf Spring 85000 Series	F6HT-18045-AA	OIO	85054	....	....	....

### AT9513

96-98	All Models with 10000 lb or 12000 lb Axle and 54" Taperleaf Spring	F6HT-18045-AC F6HZ-18124-A F6HZ-18124-G	OIO	85054	....	....	....
-------	--	---	-----	-------	------	------	------

# APPLICATION GUIDE

Year	Fitment Notes	OEM#					
			Fleetline	GasSLX	Fleetline	GasSLX	Cab Shock/ Specialty Shock

## FORD

## FORD

### AT9513 (cont)

96-98	All with 12000 lb, 13000 lb or 14600 lb Axle and 60" Taperleaf Spring	F6HT-18045-EB F6HT-18045-EC F6HZ-18124-F F6HZ-18124-E F6HZ-18124-D	OO	85055	89439				
	All with 13200 lb or 14600 lb Axle and 54" Taperleaf Spring	F6HT-18045-GC F6HT-18045-GB	OO	85030	89440				
	All with 23000 lb Axle and 52" Taperleaf spring	F5HZ-18125-A				OO	85314	89425	
	All with Hendrickson HAS-400, HA-210 or HA-230 Air Suspension	F6HZ-18080-FC 47902-28 F6HZ-18125-D				OO	85013	89414	
	All with Neway AD-246 Air Suspension	90045099 90045132				OO	85906	89407	
	Models with 10000 lb Axle and 54" Multileaf Spring	F6HT-18045-KA	OO		89402				
	Models with 12000 or 13200 lb Axle and 54" Multileaf Spring	F6HT-18045-BC	OO	85047	89435				
	Models with 21000 lb or 23000 lb Axle and 46" Taperleaf spring	F5HZ-18125-B				OO	85001	89410	
	Models with 8500 or 9000 lb Axle and 54" Taperleaf Spring	F6HT-18045-HC	OO	85054					
	Models with Hendrickson 40LH Model Tandem Axle	F6HT-18080-DA F6HZ-18125-B F6HT-18080-B 57241-2				OO	83109		

### AT9522

97-98	All Models with 10000 lb or 12000 lb Axle and 54" Taperleaf Spring	F6HT-18045-AC F6HZ-18124-A F6HZ-18124-G	OO	85054	....				
	All with 12000 lb, 13000 lb or 14600 lb Axle and 60" Taperleaf Spring	F6HT-18045-EB F6HT-18045-EC F6HZ-18124-F F6HZ-18124-E F6HZ-18124-D	OO	85055	89439				
	All with 13200 lb or 14600 lb Axle and 54" Taperleaf Spring	F6HT-18045-GC F6HT-18045-GB	OO	85030	89440				
	All with 23000 lb Axle and 52" Taperleaf spring	F5HZ-18125-A				OO	85314	89425	
	All with Hendrickson HAS-400, HA-210 or HA-230 Air Suspension	F6HZ-18080-FC 47902-28 F6HZ-18125-D				OO	85013	89414	
	All with Neway AD-246 Air Suspension	90045099 90045132				OO	85906	89407	
	Models with 10000 lb Axle and 54" Multileaf Spring	F6HT-18045-KA	OO		89402				
	Models with 12000 or 13200 lb Axle and 54" Multileaf Spring	F6HT-18045-BC	OO	85047	89435				
	Models with 21000 lb or 23000 lb Axle and 46" Taperleaf spring	F5HZ-18125-B				OO	85001	89410	
	Models with 8500 or 9000 lb Axle and 54" Taperleaf Spring	F6HT-18045-HC	OO	85054					
Models with Hendrickson 40LH Model Tandem Axle	F6HT-18080-DA F6HZ-18125-B F6HT-18080-B 57241-2				OO	83109			

### B - SERIES - BUS COWL CHASSIS

94-97	B - 700 with 21000 lb Taperleaf Springs 85000 Series	F4HT-18080-BA		....	....	OO	85001	....	....
	B - 700 with 21000 lb Taperleaf Springs 89000 Series	F4HT-18080-BA				OO		89410	
	B - 800 with 21000 lb Taperleaf Springs 85000 Series	F4HT-18080-BA				OO	85001		
	B - 800 with 21000 lb Taperleaf Springs 89000 Series	F4HT-18080-BA				OO		89410	

### B-600

80-94	B - Series - Bus Cowl Chassis	F1HT-18045-AA E0HT-18045-AB E0HT-18045-AA	OO	83309	....				
-------	-------------------------------	---	----	-------	------	--	--	--	--

### B-700

80-94	B - Series - Bus Cowl Chassis	F1HT-18045-AA E0HT-18045-AB E0HT-18045-AA	OO	83309	....				
94	Models with with 14600 lb Multileaf Spring	F4HT-18045-EA	OO	83125					

# APPLICATION GUIDE

Year	Fitment Notes	OEM#					
			Fleetline	GasSLX	Fleetline	GasSLX	Cab Shock\ Specialty Shock

## FORD

## FORD

### B-700 (cont)

94	Models with with 15000, 17500, 19000 lb Taperleaf Springs	F4HT-18080-AB F4HT-18080-AA	....	....	○	85314	89425	....
----	---	--------------------------------	------	------	---	-------	-------	------

### B-800

95-98	Models with with 14600 lb Multileaf Spring	F4HT-18045-EA	○	83125	....	....	....	....
95-97	Models with 52" Multileaf Spring	F4HT-18045-CB	○	83107	....	....	....	....
	Models with with 15000, 17500, 19000 lb Taperleaf Springs	F4HT-18080-AB F4HT-18080-AA	○	....	....	○	85314	89425
95-96	B - Series - Bus Cowl Chassis	F1HT-18045-AA E0HT-18045-AB E0HT-18045-AA	○	83309	....	....	....	....

### B-7000

83-87	B - Series - Bus Cowl Chassis	F1HT-18045-AA E0HT-18045-AB E0HT-18045-AA	○	83309	....	....	....	....
-------	-------------------------------	---	---	-------	------	------	------	------

### C & CT SERIES - TILT CAB

87-90	C-600, C-700, C-800, C-7000, CT-800, CT-8000 with 4040, 5040 lb. Springs and 7000, 9000, 12000 lb. Axles 83000 Series	D2EF-18045-AA	○	83312	....	....	....	....
	C-600, C-700, C-800, C-7000, CT-800, CT-8000 with 4040, 5040 lb. Springs and 7000, 9000, 12000 lb. Axles 89000 Series	D2EF-18045-AA	○	....	89409	....	....	....
76-79	C-600, C-700, C-750, C-800, C-900, CT-800, CT-900 Models 83000 Series	D2EF-18045-AA D7KF-18045-EA	○	83312	....	....	....	....
	C-600, C-700, C-750, C-800, C-900, CT-800, CT-900 Models 89000 Series	D2EF-18045-AA D7KF-18045-EA	○	....	89409	....	....	....
69-79	C-750, C-800, C-850, C-900, CT-750, CT-800, CT-850, CT-900, CT-950 with 9000 lb. to 15000 lb. Axles 83000 Series	C8HA-18045-A D2KF-18045-AA D1TF-18045-LA	○	83312	....	....	....	....
	C-750, C-800, C-850, C-900, CT-750, CT-800, CT-850, CT-900, CT-950 with 9000 lb. to 15000 lb. Axles 89000 Series	C8HA-18045-A D2KF-18045-AA D1TF-18045-LA	○	....	89409	....	....	....
71-73	C-500, C-550, C-600, C-650, C-700, C-750 with 6000 & 7000 lb. Axle 83000 Series	D1TF-18045-LA	○	83312	....	....	....	....
	C-500, C-550, C-600, C-650, C-700, C-750 with 6000 & 7000 lb. Axle 89000 Series	D1TF-18045-LA	○	....	89409	....	....	....
67-71	C-600, C-650, C-700, C-750, C-800, C-850, C-1000 with 7000, 9000, 11000, 12000,15000 lb. Axles and 175" Wheel Base 83000 Series	C8HA-18045-A	○	83312	....	....	....	....
	C-600, C-650, C-700, C-750, C-800, C-850, C-1000 with 7000, 9000, 11000, 12000,15000 lb. Axles and 175" Wheel Base 89000 Series	C8HA-18045-A	○	....	89409	....	....	....
67-69	C-600, C-650, C-700, C-750, C-800, C-850, C-1000 with 7000, 9000, 11000, 12000,15000 lb. Axles - Exc. with 175" Wheel Base 83000 Series	D2HF-18045-CA	○	83308	....	....	....	....
64-67	C-550, C-600 with 6000 lb. Axle - and Power Steering 83000 Series	C2TA-18045-A	○	83216	....	....	....	....
	C-550, C-600, C-650, C-700, C-750 Models 83000 Series	C6PF-18077-F	○	....	....	○	83225	....
64-66	C700/1100, CT-700/1100 with 7000, 9000, 11000, 15000 lb. Axles 83000 Series	D2HF-18045-CA	○	83308	....	....	....	....

### C700

80-86	Models with 3100 lb Spring and 7000 lb Axle	D7HT-18045-JA	○	83308	....	....	....	....
	Models with 4040, 5040 lb Springs and 7000, 9000, 12000 lb Axles	D2EF-18045-AA	○	83312	89409	....	....	....

### C800

80-89	Models with 3100 lb Spring and 7000 lb Axle	D7HT-18045-JA	○	83308	....	....	....	....
80-86	Models with 4040, 5040 lb Springs and 7000, 9000, 12000 lb Axles	D2EF-18045-AA	○	83312	89409	....	....	....

### C7000

80-86	Models with 3100 lb Spring and 7000 lb Axle	D7HT-18045-JA	○	83308	....	....	....	....
	Models with 4040, 5040 lb Springs and 7000, 9000, 12000 lb Axles	D2EF-18045-AA	○	83312	89409	....	....	....

### C8000

80-90	Models with 3100 lb Spring and 7000 lb Axle	D7HT-18045-JA	○	83308	....	....	....	....
-------	---	---------------	---	-------	------	------	------	------

# APPLICATION GUIDE

Year	Fitment Notes	OEM#					
			Fleetline	GasSLX	Fleetline	GasSLX	Cab Shock Specialty Shock

## FORD

## FORD

### CF SERIES (BRAZILIAN BUILT)

86-89	CF - 600, CF - 700 Models 85000 Series	E5HT-18045-AA	○	85301	....	....	....	....
		E5HT-18080-EA E5HT-18080-DA	○	....	....	....	....	....

#### CF7000

96-97	Models with 16000 lb. Multileaf Spring	F6HT-18045-AA	○	85054	....	....	....	....
92-97	Models with 9000 lb Axle	F2HZ-18124-A F2HT-18045-BA F2HT-18045-CA F6HT-18045-LA	○	85376	....	....	....	....
86-97	Models with 12000 lb or 13000 lb Axle	87HU-18045-AA E6HZ-18124-A E5HT-18045-AA E7HZ-18124-A	○	85301	....	....	....	....
		....	....	....	....	....	....	....

#### CF8000

96-97	Models with 16000 lb. Multileaf Spring	F6HT-18045-AA	○	85054	....	....	....	....
92-97	Models with 9000 lb Axle	F2HZ-18124-A F2HT-18045-BA F2HT-18045-CA F6HT-18045-LA	○	85376	....	....	....	....
87-97	Models with 12000 lb or 13000 lb Axle	87HU-18045-AA E6HZ-18124-A E5HT-18045-AA E7HZ-18124-A	○	85301	....	....	....	....
		....	....	....	....	....	....	....

#### CFT8000

96-97	Models with 16000 lb. Multileaf Spring	F6HT-18045-AA	○	85054	....	....	....	....
92-97	Models with 9000 lb Axle	F2HZ-18124-A F2HT-18045-BA F2HT-18045-CA F6HT-18045-LA	○	85376	....	....	....	....

### CL & CLT SERIES - HIGHWAY TRACTOR TILT CAB

	Models with Hendrickson Rear Air Suspension 83000 Series	47902-13	○	....	....	....	....	....
	Models with Hendrickson Rear Air Suspension 89000 Series	47902-13	○	....	....	....	....	....
78-80	CL-9000, CLT-9000 Models 85000 Series	D7HT-18045-NA	○	85301	....	....	....	....
	CL-9000, CLT-9000 with Rear Tandem Axle with Neway Suspension 83000 Series	D7HA-18080-AA	○	....	....	....	....	....
	CL-9000, CLT-9000 with Rear Tandem Axle with Neway Suspension 89000 Series	D7HA-18080-AA	○	....	....	....	....	....
	CL-9000, CLT-9000 with Single Rear Axle Suspension 83000 Series	D4HA-18080-AA	○	....	....	....	....	....
	CL-9000, CLT-9000 with Single Rear Axle Suspension 89000 Series	D4HA-18080-AA	○	....	....	....	....	....

#### CL9000

90-91	Models with Multileaf Spring	F1HT-18045-NA	○	85040	....	....	....	....
81-91	Models with O.E.M. Number	D7HT-18045-NA	○	85301	....	....	....	....
	Models with Rear Tandem Axle with Neway Suspension	D7HA-18080-AA	○	....	....	....	....	....
	Models with Single Rear Axle Suspension	D4HA-18080-AA	○	....	....	....	....	....

#### CLT9000

90-91	Models with Multileaf Spring	F1HT-18045-NA	○	85040	....	....	....	....
81-91	Models with O.E.M. Number	D7HT-18045-NA	○	85301	....	....	....	....
	Models with Rear Tandem Axle with Neway Suspension	D7HA-18080-AA	○	....	....	....	....	....
	Models with Single Rear Axle Suspension	D4HA-18080-AA	○	....	....	....	....	....

#### CT800D

81-82	Models with 3100 lb Spring and 7000 lb Axle	D7HT-18045-JA	○	83308	....	....	....	....
-------	---	---------------	---	-------	------	------	------	------



# APPLICATION GUIDE

Year	Fitment Notes	OEM#					
			Fleetline	GasSLX	Fleetline	GasSLX	Cab Shock\ Specialty Shock

## FORD

## FORD

### CT8000

81-90	Models with 3100 lb Spring and 7000 lb Axle	D7HT-18045-JA	OO	83308	....			
81-86	Models with 4040, 5040 lb Springs and 7000, 9000, 12000 lb Axles	D2EF-18045-AA	OO	83312	89409			

### F SERIES - CONVENTIONAL CAB

90	F-650 with 13000 & 15000 lb Rear Axle 83000 Series	D7HT-18080-BA		....	....			
	F-8000, FT-700, FT-8000 - Exc. 9000 lb Axle with H.D. Suspension & 12000 lb Axle 83000 Series	E0HT-18045-AB E0HT-18045-AA	OO	83309	....			
88-89	F-8000, FT-700, FT-8000 - Exc. 9000 lb. Axle with H.D. Suspension & 12000 lb. Axle 83000 Series	E0HT-18045-AB E0HT-18045-AA	OO	83309	....			
81-89	F-650 with 13000 & 15000 lb. Rear Axle 83000 Series	D7HT-18080-BA	OO	....	....			
83-87	FT-700 - Exc. 9000 lb. Axle with H.D. Suspension & 12000 lb. Axle 83000 Series	E0HT-18045-AB E0HT-18045-AA	OO	83309	....			
80-82	F-8000, FT-700, FT-8000 - Exc. 9000 lb. Axle with H.D. Suspension & 12000 lb. Axle 83000 Series	E0HT-18045-AB E0HT-18045-AA	OO	83309	....			
76-79	F-800 83000 Series	D7HT-18045-GA	OO	83308	....			
		D2HT-18080-HA	OO	....	....			
73-79	F-700 (Diesel), F-750, F-800 with 9000 lb. Axle 83000 Series	D2EF-18045-AA D2TF-18045-AA D7HT-18045-BA	OO	83312	....			
	F-700 (Diesel), F-750, F-800 with 9000 lb. Axle 89000 Series	D2EF-18045-AA D2TF-18045-AA D7HT-18045-BA	OO	....	89409			
70-79	F-500, F-600, F-650, F-700, F-750, F-800 with 5500, 6000, 7000 & 9000 lb. Axles 83000 Series	D2TF-18045-GA	OO	83308	....			
	F-650, F-750, F-800 with 13000 & 15000 lb. Rear Axle 83000 Series	D7HT-18080-BA	OO	....	....			
64-79	F-500, F-600 (2 x 4), F-650, F-700, F-750 83000 Series	D2TF-18080-HA C7PF-18077-A	OO	....	....			
70-72	F-700 (Diesel), F-750 with 9000 lb. Axle 83000 Series	D2HF-18045-CA	OO	83308	....			
64-69	F-500, F-600, F-700, F-750 with 6000 & 7000 Axle 83000 Series	C2TA-18045-A	OO	83216	....			
	F-600, F-650, F-700, F-750, F-800 with 13000 & 15000 lb. Rear Axle 83000 Series	D7HT-18080-BA	OO	....	....			
	F-800, F-850, F-900, F-950, F-1000 with 6000, 7000, 9000, 11000, 12000, 15000, 18000 lb. Axles (Exc. Diesel with 6000 and 7000 lb. Axles) 83000 Series	C1TT-18045-C C6PF-18077-DL	OO	83312	....			
	F-800, F-850, F-900, F-950, F-1000 with 6000, 7000, 9000, 11000, 12000, 15000, 18000 lb. Axles (Exc. Diesel with 6000 and 7000 lb. Axles) 89000 Series	C1TT-18045-C C6PF-18077-DL	OO	....	89409			
	F-950, F-1000, F-1100 Diesel with 7000 lb. Axle 83000 Series	C6PF-18077-DN	OO	83314	....			

### F-53

08-23	F53 Chassis with 24,000 lb GVW to 26,000 lb GVW 85000 Series	ASH-25821 ASH-1161 HU9Z-18124-A	OO	85006	....			
		ASH-25820 ASH-1162	OO	....	....			
	F53 Chassis with 24,000 lb GVW to 26,000 lb GVW 89000 Series	ASH-25820 ASH-1162	OO	....	....			
06-23	F-53 Chassis with 16,000 lb GVW to 18,000 lb GVW 83000 Series	ASH-1206 9U94-18080-AA 9U9Z-18125-B AT-621 ASH-25825 ASH-25824 9U9Z-18125-A ASH-1023 ASH-1230 ASH-137 HU9Z-18125-B	OO	....	....			
	F-53 Chassis with 16,000 lb GVW to 18,000 lb GVW 89000 Series	ASH-1206 9U94-18080-AA 9U9Z-18125-B AT-621 ASH-25825 ASH-25824 9U9Z-18125-A ASH-1023 ASH-1230 ASH-137 HU9Z-18125-B	OO	....	....			

# APPLICATION GUIDE

Year	Fitment Notes	OEM#					
			Fleetline	GasSLX	Fleetline	GasSLX	Cab Shock Specialty Shock



## FORD

## FORD

### F-53 (cont)

06-23	F53 Chassis with 16,000 lb GVW to 22,000 lb GVW 83000 Series	ASH-1229 HU94-18045-AA ASH-1228 9U94-18045-AA ASH-1205 AT-620 ASH-1022 HU9Z-18124-B HU9Z-18124-C HU94-18045-BA ASH-294 9U9Z-18124-A 9U9Z-18124-B ASH-25822 ASH-25823 1C34-18045-JA AT-766	83209	....	O/O	....	....	....
	F53 Chassis with 16,000 lb GVW to 22,000 lb GVW 89000 Series	ASH-1229 HU94-18045-AA ASH-1228 9U94-18045-AA ASH-1205 AT-620 ASH-1022 HU9Z-18124-B HU9Z-18124-C HU94-18045-BA ASH-294 9U9Z-18124-A 9U9Z-18124-B ASH-25822 ASH-25823 1C34-18045-JA AT-766	....	89414	O/O	....	....	....
11-20	F53 Stripped Chassis Commercial Stripped Chassis, 19,500 lb to 22,000 lb GVW 85000 Series	471700007203 ASH-24634 DU94-18045-CB	85013	....	O/O	....	....	....
	F53 Stripped Chassis Commercial Stripped Chassis, 19,500 lb to 22,000 lb GVW 89000 Series	471700007203 ASH-24634 DU94-18045-CB	....	89414	O/O	....	....	....
	F53 Stripped Chassis With BT Delivery Van Pack, 16,000 LB. GVW 85000 Series	471700009775 DU94-18080-CA 471700007117 DU94-18080-CB	....	....	O/O	85010	....	....
99-04	F-53 Chassis with 16,000 lb GVW to 18,000 lb GVW 83000 Series	ASH-1206 9U94-18080-AA AT-621 ASH-25824 9U9Z-18125-A ASH-1023 ASH-1230 ASH-137 HU9Z-18125-B	....	....	O/O	83122	....	....
	F-53 Chassis with 16,000 lb GVW to 18,000 lb GVW 89000 Series	ASH-1206 9U94-18080-AA AT-621 ASH-25824 9U9Z-18125-A ASH-1023 ASH-1230 ASH-137 HU9Z-18125-B	....	....	O/O	....	89406	....
	F53 Chassis with 16,000 lb GVW to 22,000 lb GVW 83000 Series	ASH-1229 HU94-18045-AA ASH-1228 9U94-18045-AA ASH-1205 AT-620 ASH-1022 HU9Z-18124-B HU9Z-18124-C HU94-18045-BA ASH-294 9U9Z-18124-A 9U9Z-18124-B ASH-25822 ASH-25823 1C34-18045-JA AT-766	83209	....	O/O	....	....	....

# APPLICATION GUIDE

Year	Fitment Notes	OEM#					
			Fleetline	GasSLX	Fleetline	GasSLX	Cab Shock\ Specialty Shock

## FORD

## FORD



### F-53 (cont)

99-04	F53 Chassis with 16,000 lb GVW to 22,000 lb GVW 89000 Series	ASH-1229 HU94-18045-AA ASH-1228 9U94-18045-AA ASH-1205 AT-620 ASH-1022 HU9Z-18124-B HU9Z-18124-C HU94-18045-BA ASH-294 9U9Z-18124-A 9U9Z-18124-B ASH-25822 ASH-25823 1C34-18045-JA AT-766	OIO	89414				
88-97	F53 Chassis with 16,000 lb GVW to 22,000 lb GVW 83000 Series	ASH-1229 HU94-18045-AA ASH-1228 9U94-18045-AA ASH-1205 AT-620 ASH-1022 HU9Z-18124-B HU9Z-18124-C HU94-18045-BA ASH-294 9U9Z-18124-A 9U9Z-18124-B ASH-25822 ASH-25823 1C34-18045-JA AT-766	OIO	83209	....	....	....	....
	F53 Chassis with 16,000 lb GVW to 22,000 lb GVW 89000 Series	ASH-1229 HU94-18045-AA ASH-1228 9U94-18045-AA ASH-1205 AT-620 ASH-1022 HU9Z-18124-B HU9Z-18124-C HU94-18045-BA ASH-294 9U9Z-18124-A 9U9Z-18124-B ASH-25822 ASH-25823 1C34-18045-JA AT-766	OIO	89414	....	....	....	....

### F-53 MOTORHOME CHASSIS

25	F53 Chassis with 16,000 lb GVW to 22,000 lb GVW	1C34-18045-JA	OIO	83209	....			
		ASH-1229 HU94-18045-AA ASH-1228 9U94-18045-AA ASH-1205 AT-620 ASH-1022 6U9Z18124D HU9Z-18124-B HU9Z-18124-C HU94-18045-BA ASH-294 9U9Z-18124-A 9U9Z-18124-B ASH-25822 ASH-25823 AT-766	OIO	83209	89414	....	....	....
24	F53 Chassis with 16,000 lb GVW to 22,000 lb GVW	1C34-18045-JA	OIO	83209	....	....	....	....

# APPLICATION GUIDE

Year	Fitment Notes	OEM#					
			Fleetline	GasSLX	Fleetline	GasSLX	Cab Shock! Specialty Shock

**FORD**

**FORD**

## F-53 MOTORHOME CHASSIS (cont)

24	F53 Chassis with 16,000 lb GVW to 22,000 lb GVW	ASH-1229 HU94-18045-AA ASH-1228 9U94-18045-AA ASH-1205 AT-620 ASH-1022 6U9Z18124D HU9Z-18124-B HU9Z-18124-C HU94-18045-BA ASH-294 9U9Z-18124-A 9U9Z-18124-B ASH-25822 ASH-25823 AT-766	OO	83209	89414	....	....	....
	MotorHomes with Ford F53 Chassis with 24,000 lb GVW to 26,000 lb GVW 85000 Series	ASH-25821 ASH-1161 HU9Z-18124-A	OO	85006	....	....	....	....
08-23	MotorHomes with Ford F53 Chassis with 24,000 lb GVW to 26,000 lb GVW	ASH-25821 ASH-1161 HU9Z-18124-A	OO	85006	....	....	....	....
		ASH-25820 ASH-1162	OO	....	....	85005	89430	....
06-23	F53 Chassis with 16,000 lb GVW to 22,000 lb GVW	ASH-1229 HU94-18045-AA ASH-1228 9U94-18045-AA ASH-1205 AT-620 ASH-1022 HU9Z-18124-B HU9Z-18124-C HU94-18045-BA ASH-294 9U9Z-18124-A 9U9Z-18124-B ASH-25822 ASH-25823 1C34-18045-JA AT-766	OO	83209	89414	....	....	....
	Motorhome Chassis with 16,000 lb GVW to 18,000 lb GVW	ASH-1206 9U94-18080-AA 9U9Z-18125-B AT-621 ASH-25825 ASH-25824 9U9Z-18125-A ASH-1023 ASH-1230 ASH-137 HU9Z-18125-B	OO	....	....	83122	89406	....
	Motorhome Chassis with 20,500 lb GVW to 22,000 lb GVW	ASH-1206 9U94-18080-AA AT-621 ASH-25824 9U9Z-18125-A ASH-1023 ASH-1230 ASH-137 HU9Z-18125-B	OO	....	....	83122	89406	....
11-20	F53 Stripped Chassis Commercial Stripped Chassis, 19,500 lb to 22,000 lb GVW	47 1700 007 203 ASH-24634 DU94-18045-CB	OO	85013	89414	....	....	....
	F53 Stripped Chassis With BT Delivery Van Pack, 16,000 LB. GVW	471700009775 DU94-18080-CA 471700007117 DU94-18080-CB	OO	....	....	85010	....	....
05	MotorHomes with Ford F53 Chassis with 16,000 lb GVW to 22,000 lb GVW 83000 Series	ASH-1229 ASH-1228 9U94-18045-AA ASH-1205 AT-620 ASH-1022 1C34-18045-AA ASH-294 9U9Z-18124-A ASH-25822 ASH-25823 1C34-18045-JA AT-766	OO	83209	....	....	....	....

# APPLICATION GUIDE

Year	Fitment Notes	OEM#					
				Fleetline	GasSLX		Fleetline

## FORD

## FORD

### F-53 MOTORHOME CHASSIS (cont)

05	MotorHomes with Ford F53 Chassis with 16,000 lb GVW to 22,000 lb GVW 89000 Series	ASH-1229 ASH-1228 9U94-18045-AA ASH-1205 AT-620 ASH-1022 1C34-18045-AA ASH-294 9U9Z-18124-A ASH-25822 ASH-25823 1C34-18045-JA AT-766	OIO	....	89414	....	....	....
99-04	F53 Chassis with 16,000 lb GVW to 22,000 lb GVW	ASH-1229 HU94-18045-AA ASH-1228 9U94-18045-AA ASH-1205 AT-620 ASH-1022 HU9Z-18124-B HU9Z-18124-C HU94-18045-BA ASH-294 9U9Z-18124-A 9U9Z-18124-B ASH-25822 ASH-25823 1C34-18045-JA AT-766	OIO	83209	89414	....	....	....
	Motorhome Chassis with 16,000 lb GVW to 18,000 lb GVW	ASH-1206 9U94-18080-AA 9U9Z-18125-B AT-621 ASH-25825 ASH-25824 9U9Z-18125-A ASH-1023 ASH-1230 ASH-137 HU9Z-18125-B	OIO	....	....	83122	89406	....
	Motorhome Chassis with 20,500 lb GVW to 22,000 lb GVW	ASH-1206 9U94-18080-AA AT-621 ASH-25824 9U9Z-18125-A ASH-1023 ASH-1230 ASH-137 HU9Z-18125-B	OIO	....	....	83122	89406	....
98	MotorHomes with Ford F53 Chassis with 16,000 lb GVW to 22,000 lb GVW 83000 Series	ASH-1229 ASH-1228 9U94-18045-AA ASH-1205 AT-620 ASH-1022 1C34-18045-AA ASH-294 9U9Z-18124-A ASH-25822 ASH-25823 1C34-18045-JA AT-766	OIO	83209	....	....	....	....
	MotorHomes with Ford F53 Chassis with 16,000 lb GVW to 22,000 lb GVW 89000 Series	ASH-1229 ASH-1228 9U94-18045-AA ASH-1205 AT-620 ASH-1022 1C34-18045-AA ASH-294 9U9Z-18124-A ASH-25822 ASH-25823 1C34-18045-JA AT-766	OIO	....	89414	....	....	....

# APPLICATION GUIDE

Year	Fitment Notes	OEM#					
			Fleetline	GasSLX	Fleetline	GasSLX	Cab Shock Specialty Shock

## FORD

## FORD

### F-53 MOTORHOME CHASSIS (cont)

88-97	F53 Chassis with 16,000 lb GVW to 22,000 lb GVW	ASH-1229 HU94-18045-AA ASH-1228 9U94-18045-AA ASH-1205 AT-620 ASH-1022 HU9Z-18124-B HU9Z-18124-C HU94-18045-BA ASH-294 9U9Z-18124-A 9U9Z-18124-B ASH-25822 ASH-25823 1C34-18045-JA AT-766	OO	83209	89414	OO	....	....	....
	F53 Motorhome Chassis (Over 30 feet)		OO	83125	....	OO	....	....	....
	Motorhome Chassis with 16,000 lb GVW to 18,000 lb GVW	ASH-1206 9U94-18080-AA 9U9Z-18125-B AT-621 ASH-25825 ASH-25824 9U9Z-18125-A ASH-1023 ASH-1230 ASH-137 HU9Z-18125-B	OO	....	....	OO	83122	89406	....

### F-59 COMMERCIAL STRIPPED CHASSIS

24	MotorHomes with Ford F59 Commercial Chassis with 24,000 lb GVW to 26,000 lb GVW 85000 Series	ASH-25821 ASH-1161 HU9Z-18124-A	OO	85006	....	OO	....	....	....
88	F59 Commercial Chassis with 16,000 lb or 19,500 GVW	471700009775 CU9Z-18125-A ASH-12261 ASH-24523 ASH-24589 DU94-18080-CA BU9Z-18125-A 471700007117 ASH-24474 DU94-18080-CB DU9Z-18125-A DU9Z-18125-B	OO	....	....	OO	85010	....	....
	F59 Commercial Chassis with 16,000 lb to 22,000 GVW	ASH-12251 CU9Z-18124-A ASH-24473 BU9Z-18124-A ASH-24522 ASH-24634 DU9Z-18124-A DU9Z-18124-B	OO	85013	89414	OO	....	....	....

### F-600

86-94	Models with O.E.M. Number	AX-310 ASH-24446 E6HT-18080-AA E6HZ-18125-D	OO	....	....	OO	83215	....	....
80-94	Exc. 9000 lb Axle with H.D. Suspension & 12000 lb Axle	EOHT-18045-AB EOHT-18045-AA	OO	83309	....	OO	....	....	....
80-90	Models with 17000 & 18000 lb Rear Axle	D7HT-18080-DA D7HF-18080-AA	OO	....	....	OO	83215	....	....
70-90	Models with 13000 & 15000 lb Rear Axle	D7HT-18080-BA	OO	....	....	OO	83225	....	....
90	Models with Multileaf Spring	F1HT-18045-AA	OO	83309	....	OO	....	....	....
83-89	Models with 9000 lb Axle with H.D. Suspension & 12000 lb Axle	D7HT-18045-CA D2HF-18045-AA	OO	83314	....	OO	....	....	....

### F-600 LPO

90-94	Models with O.E.M. Number	E9HS-18080-AA	OO	....	....	OO	85716	....	....
-------	---------------------------	---------------	----	------	------	----	-------	------	------

### F-650

21-24	Models with 19.5" or 22.5" Wheels (22,000 lb GVW)	FC4Z-18124-B FC4Z-18124-A ASH-24659 ASH-24658 471700011530 FC44-18045-BB	OO	85181	....	OO	....	....	....
-------	---	---	----	-------	------	----	------	------	------

# APPLICATION GUIDE

Year	Fitment Notes	OEM#					
			Fleetline	GasSLX	Fleetline	GasSLX	Cab Shock\ Specialty Shock

## FORD

## FORD

### F-650 (cont)

21-24	Models with 13,500, 15,500 & 19,000 lb Multi-leaf Rear Springs	FC4Z-18125-A ASH-24660 471700011531 FC44-18080-AB	OIO	85180	....	....	OIO	85180	....	....
	Models with Hendrickson HAS - 400/460 Rear Air Suspension	60675-014 ASH-25838 FC4Z-18125-E	OIO	85978	....	....	OIO	85978	....	....
	Models with Hendrickson Rear Air Suspension	60670-011 FC4Z-18125-D ASH-24663	OIO	83148	....	....	OIO	83148	....	....
		60670-012 ASH-24662 FC4Z-18125-C	OIO	83168	....	....	OIO	83168	....	....
	20	Models with Hendrickson Rear Air Suspension 83000 Series	60670-011 FC4Z-18125-D ASH-24663	OIO	83148	....	....	OIO	83148	....
15-19	Models with 19.5" or 22.5" Wheels (22,000 lb GVW)	FC4Z-18124-B FC4Z-18124-A ASH-24659 ASH-24658 471700011530 FC44-18045-BB	OIO	85181	....	....	OIO	85181	....	....
	Models with 13,500, 15,500 & 19,000 lb Multi-leaf Rear Springs	FC4Z-18125-A ASH-24660 471700011531 FC44-18080-AB	OIO	85180	....	....	OIO	85180	....	....
	Models with Hendrickson HAS - 400/460 Rear Air Suspension	60675-014 ASH-25838 FC4Z-18125-E	OIO	85978	....	....	OIO	85978	....	....
	Models with Hendrickson Rear Air Suspension	60670-011 FC4Z-18125-D ASH-24663	OIO	83148	....	....	OIO	83148	....	....
		60670-012 ASH-24662 FC4Z-18125-C	OIO	83168	....	....	OIO	83168	....	....
	15	Models with 10,000 lb Front Suspension	3584116C1 3584116C2 ASH-24492 AA-616 2C44-18045-BA 4C4Z-18124-QA	OIO	83175	....	OIO	83175	....	....
	Models with 12,000 & 13,200 lb Front Springs	4C4Z-18124-JB 3584118C2 AA-617 4C4Z-18124-RA AT-812	OIO	85928	....	....	OIO	85928	....	....
	Models with 21,000 lb Rear Air Suspension	3578858C1 3578858C2 4C4Z-18125-DA	OIO	85656	....	....	OIO	85656	....	....
	Models with 22,000 lb Multi-leaf Rear Springs	4C4Z-18125-B 501906C91 501906C92 ASH-24661	OIO	83317	....	....	OIO	83317	....	....
	Models with 8,500 lb Front Suspension	4C4Z-18124-HB AA-615 FC4Z-18124-HB 3584117C2 4C4Z-18124-P AT-811	OIO	83135	....	....	OIO	83135	....	....
	Models with Hendrickson HAS - 230 Rear Air Suspension	4C4Z-18125-CA 60675-003 ASH-1105 ASH-722 60675-003L	OIO	85976	....	....	OIO	85976	....	....
	Models with International Air Suspension (4x2)	AA-619 3553628C1 3553628C2	OIO	85927	....	....	OIO	85927	....	....
14	Models with 10,000 lb Front Suspension 83000 Series	3584116C1 3584116C2 ASH-24492 AA-616 2C44-18045-BA 4C4Z-18124-QA	OIO	83175	....	....	OIO	83175	....	....
	Models with 12,000 & 13,200 lb Front Springs 85000 Series	4C4Z-18124-JB 3584118C2 AA-617 4C4Z-18124-RA AT-812	OIO	85928	....	....	OIO	85928	....	....
	Models with 21,000 lb Rear Air Suspension 85000 Series	3578858C1 3578858C2 4C4Z-18125-DA	OIO	85656	....	....	OIO	85656	....	....



# APPLICATION GUIDE

Year	Fitment Notes	OEM#					
			Fleetline	GasSLX	Fleetline	GasSLX	Cab Shock Specialty Shock

## FORD

## FORD

### F-650 (cont)

14	Models with 22,000 lb Multi-leaf Rear Springs 83000 Series	4C4Z-18125-B 501906C91 501906C92 ASH-24661	....	....	83317	....	....
	Models with 8,500 lb Front Suspension 83000 Series	4C4Z-18124-HB AA-615 FC4Z-18124-HB 3584117C2 4C4Z-18124-P AT-811	OO	83135	....	....	....
	Models with Hendrickson HAS - 230 Rear Air Suspension 85000 Series	4C4Z-18125-CA 60675-003 ASH-1105 ASH-722 60675-003L	OO	....	....	85976	....
	Models with International Air Suspension (4x2) 85000 Series	AA-619 3553628C1 3553628C2	OO	....	....	85927	....
04-13	Models with 21,000 lb Rear Air Suspension	3578858C1 3578858C2 4C4Z-18125-DA	OO	....	....	85656	....
	Models with 22,000 lb Multi-leaf Rear Springs	4C4Z-18125-B 501906C91 501906C92 ASH-24661	OO	....	....	83317	....
	Models with Hendrickson HAS - 230 Rear Air Suspension	4C4Z-18125-CA 60675-003 ASH-1105 ASH-722 60675-003L	OO	....	....	85976	....
	Models with International Air Suspension (4x2)	AA-619 3553628C1 3553628C2	OO	....	....	85927	....
02-13	Models with Vari-Rate Rear Suspension	AA-620 4C4Z-18125-CC	OO	....	....	83101	....
00-13	Models with 10,000 lb Front Suspension	3584116C1 3584116C2 ASH-24492 AA-616 2C44-18045-BA 4C4Z-18124-QA	OO	83175	....	....	....
	Models with 12,000 & 13,200 lb Front Springs	4C4Z-18124-JB 3584118C2 AA-617 4C4Z-18124-RA AT-812	OO	85928	....	....	....
	Models with 8,500 lb Front Suspension	4C4Z-18124-HB AA-615 FC4Z-18124-HB 3584117C2 4C4Z-18124-P AT-811	OO	83135	....	....	....
00-03	Models with 23,000 lb Multi-leaf Rear Springs	F81Z-18125-ZA AT-696 AT696 ASH-2447 F81A-18080-ZC	OO	....	....	83140	....
	Models with Hendrickson HAS - 190 Rear Air Suspension	1C44-18080-AA 60670-008 60670-008L	OO	....	....	83123	89405
00-02	Models with 8500 or 9000 lb Front Axle	XC35-18045-JA AA-494 ASH-397 3U2Z-18124-MAA XC35-18045-AB XC3Z-18124-JA XC35-18045-AD	OO	83131	....	....	....

### F-700

94-98	Models with Taperleaf Springs and with 6000, 7000, 8500, 9000 lb Axle	F5HZ-18124-A F4HT-18045-AB F4HT-18045-AC	OO	83314	....	....	....
	Models with with 15000, 17500, 19000 lb Taperleaf Springs	F4HT-18080-AB F5HZ-18125-A F4HT-18080-AA	OO	....	....	85314	89425
86-98	Models with O.E.M. Number	AX-310 ASH-24446 E6HT-18080-AA E6HZ-18125-D	OO	....	....	83215	....
94-97	Models with 52" or 54" Taperleaf Springs and with 10000 or 12000 lb Axle	F4HT-18045-DA F5HZ-18124-C	OO	85063	....	....	....

# APPLICATION GUIDE

Year	Fitment Notes	OEM#					
			Fleetline	GasSLX	Fleetline	GasSLX	Cab Shock\ Specialty Shock

## FORD

## FORD

### F-700 (cont)

94-97	w/ Multileaf Spring and w/ 10000, 12000 or 13200 lb Axle	F4HT-18045-CB F5HZ-18124-B	OIO	83107	....	....	....	....
80-94	Exc. 9000 lb Axle with H.D. Suspension & 12000 lb Axle	E0HT-18045-AB E0HT-18045-AA	OIO	83309	....	....	....	....
94	Models with with 14600 lb Multileaf Spring	F4HT-18045-EA F5HZ-18124-D	OIO	83125	....	....	....	....
80-90	Models with 17000 & 18000 lb Rear Axle	D7HT-18080-DA D7HF-18080-AA	OIO	....	....	83215	....	....
70-90	Models with 13000 & 15000 lb Rear Axle	D7HT-18080-BA	OIO	....	....	83225	....	....
90	Models with Multileaf Spring	F1HT-18045-AA	OIO	83309	....	....	....	....
83-89	Models with 9000 lb Axle with H.D. Suspension & 12000 lb Axle	D7HT-18045-CA D2HF-18045-AA	OIO	83314	....	....	....	....





### F-700 LPO

90-94	Models with O.E.M. Number	E9HS-18080-AA	OIO	....	....	85716	....	....
-------	---------------------------	---------------	-----	------	------	-------	------	------

### F-750

21-24	Models with 19.5" or 22.5" Wheels (22,000 lb GVW)	FC4Z-18124-B FC4Z-18124-A ASH-24659 ASH-24658 471700011530 FC44-18045-BB	OIO	85181	....	....	....	....								
	Models with 13,500, 15,500 & 19,000 lb Multi-leaf Rear Springs	FC4Z-18125-A ASH-24660 471700011531 FC44-18080-AB	OIO	....	....	85180	....	....								
	Models with Hendrickson HAS - 400/460 Rear Air Suspension	60675-014 ASH-25838 FC4Z-18125-E	OIO	....	....	85978	....	....								
	Models with Hendrickson Rear Air Suspension	60670-011 FC4Z-18125-D ASH-24663	OIO	....	....	83148	....	....								
20	Models with Hendrickson Rear Air Suspension 83000 Series	60670-011 FC4Z-18125-D ASH-24663	OIO	....	....	83148	....	....								
									Models with 19.5" or 22.5" Wheels (22,000 lb GVW)	FC4Z-18124-B FC4Z-18124-A ASH-24659 ASH-24658 471700011530 FC44-18045-BB	OIO	85181	....	....	....	
									Models with 13,500, 15,500 & 19,000 lb Multi-leaf Rear Springs	FC4Z-18125-A ASH-24660 471700011531 FC44-18080-AB	OIO	....	....	85180	....	....
									Models with Hendrickson HAS - 400/460 Rear Air Suspension	60675-014 ASH-25838 FC4Z-18125-E	OIO	....	....	85978	....	....
15-19	Models with 19.5" or 22.5" Wheels (22,000 lb GVW)	FC4Z-18124-B FC4Z-18124-A ASH-24659 ASH-24658 471700011530 FC44-18045-BB	OIO	85181	....	....	....	....								
									Models with 13,500, 15,500 & 19,000 lb Multi-leaf Rear Springs	FC4Z-18125-A ASH-24660 471700011531 FC44-18080-AB	OIO	....	....	85180	....	....
									Models with Hendrickson HAS - 400/460 Rear Air Suspension	60675-014 ASH-25838 FC4Z-18125-E	OIO	....	....	85978	....	....
									Models with Hendrickson Rear Air Suspension	60670-011 FC4Z-18125-D ASH-24663	OIO	....	....	83148	....	....
15	Models with 10,000 lb Front Suspension	3584116C1 3584116C2 ASH-24492 AA-616 2C44-18045-BA 4C4Z-18124-QA	OIO	83175	....	....	....	....								
									Models with 12,000 & 13,200 lb Front Springs	4C4Z-18124-JB 3584118C2 AA-617 4C4Z-18124-RA AT-812	OIO	85928	....	....	....	
									Models with 21,000 lb Rear Air Suspension	3578858C1 3578858C2 4C4Z-18125-DA	OIO	....	....	85656	....	....
									Models with 22,000 lb Multi-leaf Rear Springs	4C4Z-18125-B 501906C91 501906C92 ASH-24661	OIO	....	....	83317	....	....

# APPLICATION GUIDE

Year	Fitment Notes	OEM#					
			 Fleetline	GasSLX	 Fleetline	GasSLX	Cab Shock Specialty Shock

## FORD

### F-750 (cont)

## FORD

15	Models with 8,500 lb Front Suspension	4C4Z-18124-HB AA-615 FC4Z-18124-HB 3584117C2 4C4Z-18124-P AT-811	83135	...	...	...	...	...
	Models with Hendrickson HAS - 230 Rear Air Suspension	4C4Z-18125-CA 60675-003 ASH-1105 ASH-722 60675-003L	...	...	85976	...	...	...
	Models with International Air Suspension (4x2)	AA-619 3553628C1 3553628C2	...	...	85927	...	...	...
14	Models with 10,000 lb Front Suspension 83000 Series	3584116C1 3584116C2 ASH-24492 AA-616 2C44-18045-BA 4C4Z-18124-QA	83175	...	...	...	...	...
	Models with 12,000 & 13,200 lb Front Springs 85000 Series	4C4Z-18124-JB 3584118C2 AA-617 4C4Z-18124-RA AT-812	85928	...	...	...	...	...
	Models with 21,000 lb Rear Air Suspension 85000 Series	3578858C1 3578858C2 4C4Z-18125-DA	...	...	85656	...	...	...
	Models with 22,000 lb Multi-leaf Rear Springs 83000 Series	4C4Z-18125-B 501906C91 501906C92 ASH-24661	...	...	83317	...	...	...
	Models with 8,500 lb Front Suspension 83000 Series	4C4Z-18124-HB AA-615 FC4Z-18124-HB 3584117C2 4C4Z-18124-P AT-811	83135	...	...	...	...	...
	Models with Hendrickson HAS - 230 Rear Air Suspension 85000 Series	4C4Z-18125-CA 60675-003 ASH-1105 ASH-722 60675-003L	...	...	85976	...	...	...
	Models with International Air Suspension (4x2) 85000 Series	AA-619 3553628C1 3553628C2	...	...	85927	...	...	...
04-13	Models with 21,000 lb Rear Air Suspension	3578858C1 3578858C2 4C4Z-18125-DA	...	...	85656	...	...	...
	Models with 22,000 lb Multi-leaf Rear Springs	4C4Z-18125-B 501906C91 501906C92 ASH-24661	...	...	83317	...	...	...
	Models with Hendrickson HAS - 230 Rear Air Suspension	4C4Z-18125-CA 60675-003 ASH-1105 ASH-722 60675-003L	...	...	85976	...	...	...
	Models with International Air Suspension (4x2)	AA-619 3553628C1 3553628C2	...	...	85927	...	...	...
02-13	Models with Vari-Rate Rear Suspension	AA-620 4C4Z-18125-CC	...	...	83101	...	...	...
00-13	Models with 10,000 lb Front Suspension	3584116C1 3584116C2 ASH-24492 AA-616 2C44-18045-BA 4C4Z-18124-QA	83175	...	...	...	...	...
	Models with 12,000 & 13,200 lb Front Springs	4C4Z-18124-JB 3584118C2 AA-617 4C4Z-18124-RA AT-812	85928	...	...	...	...	...
	Models with 8,500 lb Front Suspension	4C4Z-18124-HB AA-615 FC4Z-18124-HB 3584117C2 4C4Z-18124-P AT-811	83135	...	...	...	...	...

# APPLICATION GUIDE

Year	Fitment Notes	OEM#					
			Fleetline	GasSLX	Fleetline	GasSLX	Cab Shock\ Specialty Shock

## FORD

## FORD

### F-750 (cont)

00-03	Models with 23,000 lb Multi-leaf Rear Springs	F81Z-18125-ZA AT-696 AT696 ASH-2447 F81A-18080-ZC	OIO	83140	....	....	83140	....	....
	Models with Hendrickson HAS - 190 Rear Air Suspension	1C44-18080-AA 60670-008 60670-008L	OIO	83123	89405	....	83123	89405	....
00-02	Models with 8500 or 9000 lb Front Axle	XC35-18045-JA AA-494 ASH-397 3U2Z-18124-MAA XC35-18045-AB XC3Z-18124-JA XC35-18045-AD	OIO	83131	....	....	....	....	....

### F-800

94-98	Models with Taperleaf Springs and with 6000, 7000, 8500, 9000 lb Axle	F5HZ-18124-A F4HT-18045-AB F4HT-18045-AC	OIO	83314	....	....	....	....	....
	Models with with 15000, 17500, 19000 lb Taperleaf Springs	F4HT-18080-AB F5HZ-18125-A F4HT-18080-AA	OIO	85314	89425	....	85314	89425	....
94-97	Models with 21000 Taperleaf Springs	F4HT-18080-BA	OIO	85001	89410	....	85001	89410	....
	Models with 52" or 54" Taperleaf Springs and with 10000 or 12000 lb Axle	F4HT-18045-DA F5HZ-18124-C	OIO	85063	....	....	....	....	....
86-97	Models with O.E.M. Number	AX-310 ASH-24446 E6HT-18080-AA E6HZ-18125-D	OIO	83215	....	....	83215	....	....
80-94	Exc. 9000 lb Axle with H.D. Suspension & 12000 lb Axle	E0HT-18045-AB E0HT-18045-AA	OIO	83309	....	....	....	....	....
94	Models with with 14600 lb Multileaf Spring	F4HT-18045-EA F5HZ-18124-D	OIO	83125	....	....	....	....	....
	w/ Multileaf Spring and w/ 10000, 12000 or 13200 lb Axle	F4HT-18045-CB F5HZ-18124-B	OIO	83107	....	....	....	....	....
80-90	Models with 17000 & 18000 lb Rear Axle	D7HT-18080-DA D7HF-18080-AA	OIO	83215	....	....	83215	....	....
90	Models with Multileaf Spring	F1HT-18045-AA	OIO	83309	....	....	....	....	....
83-89	Models with 9000 lb Axle with H.D. Suspension & 12000 lb Axle	D7HT-18045-CA D2HF-18045-AA	OIO	83314	....	....	....	....	....
80-89	Models with 13000 & 15000 lb Rear Axle	D7HT-18080-BA	OIO	83225	....	....	83225	....	....

### F-7000

83-87	Models with 9000 lb Axle with H.D. Suspension & 12000 lb Axle	D7HT-18045-CA D2HF-18045-AA	OIO	83314	....	....	....	....	....
80-87	Exc. 9000 lb Axle with H.D. Suspension & 12000 lb Axle	E0HT-18045-AB E0HT-18045-AA	OIO	83309	....	....	....	....	....

### F-8000

83-87	Exc. 9000 lb Axle with H.D. Suspension & 12000 lb Axle	E0HT-18045-AB E0HT-18045-AA	OIO	83309	....	....	....	....	....
	Models with 9000 lb Axle with H.D. Suspension & 12000 lb Axle	D7HT-18045-CA D2HF-18045-AA	OIO	83314	....	....	....	....	....





### FT800

80-90	Exc. 9000 lb Axle with H.D. Suspension & 12000 lb Axle	E0HT-18045-AB E0HT-18045-AA	OIO	83309	....	....	....	....	....
83-89	Models with 9000 lb Axle with H.D. Suspension & 12000 lb Axle	D7HT-18045-CA D2HF-18045-AA	OIO	83314	....	....	....	....	....

### FT900

94-98	Models with 46" Taperleaf Spring and 15000, 17500 or 19000 lb Axle	F4HT-18080-AB F4HT-18080-AA F5HZ-18125-DA	OIO	85314	89425	....	85314	89425	....
	Models with 46" Taperleaf Springs and 21000 lb Axle	F4HT-18080-BA	OIO	85001	89410	....	85001	89410	....
	Models with Multileaf Spring and 14600 lb Axle	F4HT-18045-EA F5HZ-18124-D	OIO	83125	....	....	....	....	....
	w/ Multileaf Spring and w/ 10000, 12000 or 13200 lb Axle	F4HT-18045-CB F5HZ-18124-B	OIO	83107	....	....	....	....	....







# APPLICATION GUIDE

Year	Fitment Notes	OEM#					
			 Fleetline	GasSLX	 Fleetline	GasSLX	Cab Shock Specialty Shock



## FORD

## FORD



### FT900 (cont)

90-98	Models with shock located forward of rear axle	AX-310 ASH-24446 E6HT-18080-AA E6HZ-18125-D	...	...	 83215	...	...
94-97	Models with 52" or 54" Taperleaf Springs and with 10000 or 12000 lb Axle	F4HT-18045-DA F5HZ-18124-C	 85063	...	...	...	...
	Models with Taperleaf Springs and with 6000, 7000, 8500 or 9000 lb Axles	F5HZ-18124-A F4HT-18045-AB	 83314	...	...	...	...
90-94	Low Profile Models with 9000 lb Axle with H.D. Suspension or 10000, 11000, or 12000 lb Axles	E9HZ-18124-A E9HS-18045-AA	 83309	...	...	...	...
	Models with 9000 lb Axle with H.D. Suspension or 10000, 11000, or 12000 lb Axles	C4HZ-18124-E F1HT-18045-AA F1HZ-18124-A	 83309	...	...	...	...
90-92	Low Profile Models with O.E.M. Number	E9HS-18080-AA	...	...	 85716	...	...









### FT8000

83-87	Exc. 9000 lb Axle with H.D. Suspension & 12000 lb Axle	E0HT-18045-AB E0HT-18045-AA	 83309	...	...	...	...
	Models with 9000 lb Axle with H.D. Suspension & 12000 lb Axle	D7HT-18045-CA D2HF-18045-AA	 83314	...	...	...	...



### H AND HT SERIES - HI TILT CAB

61-66	HT-950 with 12000 & 15000 lb. Axle 83000 Series	.....	 83314	...	...	...	...
61-63	HT-950 with 11000 lb. Axle 83000 Series	.....	 83314	...	...	...	...



### L, LT & LTS - CONVENTIONAL CAB

	L-8000, L-9000, LT-8000, LT-9000 with Hendrickson Rear Air Suspension 83000 Series	47902-13	...	...	 83122	...	...
	L-8000, L-9000, LT-8000, LT-9000 with Hendrickson Rear Air Suspension 89000 Series	47902-13	...	...	 89406	...	...
73-89	LTS-800, LTS-850, LTS-900, LTS-9000 with 16000 lb. Axle 83000 Series	D0HA-18045-E D2HF-18045-DA D7HT-18045-EA	 83312	...	...	...	...
	LTS-800, LTS-850, LTS-900, LTS-9000 with 16000 lb. Axle 89000 Series	D0HA-18045-E D2HF-18045-DA D7HT-18045-EA	 89409	...	...	...	...
73-80	L-800, L850, L-900, L-9000, LT-800, LT-850, LT880, LT-900, LT-9000, LTS-800, LTS-850, LTS-900 with 7000, 9000, 12000, 16000 lb. Axles 83000 Series	D2HF-18045-BA D7HT-18045-DA	 83309	...	...	...	...
73-79	L-800, L8000, L-900, L-9000, LT-800, LT-880, LT8000, LT-900, LT-9000 with 7000, 9000, 12000 lb. Axles 83000 Series	D7HF-18045-FA D2EF-18045-AA D2KF-18045-AA D7HT-18045-BA	 83312	...	...	...	...
	L-800, L8000, L-900, L-9000, LT-800, LT-880, LT8000, LT-900, LT-9000 with 7000, 9000, 12000 lb. Axles 89000 Series	D7HF-18045-FA D2EF-18045-AA D2KF-18045-AA D7HT-18045-BA	 89409	...	...	...	...
	L-800, L8000, L-900, L-9000, LT-800, LT-880, LT8000, LT-900, LT-9000, LTS-8000, LTS-900, LTS-9000 with 7000, 9000, 12000, 16000 lb. Axles 83000 Series	D2HT-18045-CA D2HF-18045-AA	 83314	...	...	...	...

### L-SERIES CONVENTIONAL

	All with 60" Able Body Sleepers with Link Bunkmate Models FAS60-A & FAS60-AS 83000 Series	1201-1044 1202-1044	...	...	 83025	...	...
	L, LT, LN, LNT 800, 8000, 9000 Models, LTS, LS 8000, 9000 Models, & LTL, LL 9000 Models with Link Cabmate Model FN89-A 83000 Series	1201-0012 1202-0012	...	...	 83023	...	...

### L800

80-85	Models with 7000, 9000, 12000 lb Axles	D7HF-18045-FA D2EF-18045-AA D2KF-18045-AA D7HT-18045-BA	 83312	89409	...	...	...
	Models with 7000, 9000, 12000, 16000 lb Axles	D2HF-18045-BA D7HT-18045-DA	 83309	...	...	...	...
		D2HT-18045-CA D2HF-18045-AA	 83314	...	...	...	...

### L900

81	Models with 7000, 9000, 12000 lb Axles	D7HF-18045-FA D2EF-18045-AA D2KF-18045-AA D7HT-18045-BA	 83312	89409	...	...	...
----	--	--	---	-------	-----	-----	-----

# APPLICATION GUIDE

Year	Fitment Notes	OEM#					
			Fleetline	GasSLX	Fleetline	GasSLX	Cab Shock Specialty Shock

## FORD

## FORD

### L900 (cont)

81	Models with 7000, 9000, 12000, 16000 lb Axles	D2HF-18045-BA D7HT-18045-DA	OO	83309	....	....	....	....
		D2HT-18045-CA D2HF-18045-AA	OO	83314	....	....	....	....

### L8000

81-88	Models with 7000, 9000, 12000 lb Axles	D7HF-18045-FA D2EF-18045-AA D2KF-18045-AA D7HT-18045-BA	OO	83312	89409	....	....	....
		Models with 7000, 9000, 12000, 16000 lb Axles	D2HF-18045-BA D7HT-18045-DA	OO	83309	....	....	....
81-85	Models with 7000, 9000, 12000, 16000 lb Axles	D2HT-18045-CA D2HF-18045-AA	OO	83314	....	....	....	....

### L8000F

94-97	Models with 21000 or 23000 lb. with 46" Taperleaf Spring	F4HT-18080-BA		....	....	OO	85001	89410	....
91-97	Models with 4000, 4500, 5400, 6000, 7200 lb Multileaf Springs and with 9000, 10000, 12000 or 16000 lb Axles	F1HT-18045-CB	OO	83216	....	OO	....	....	....
	Models with 4500, 5400, 6000, 7200, 10000 lb Multileaf Springs and with 10000, 12000, 13200, 16000 lb Axles	F1HT-18045-DB	OO	83308	....	OO	....	....	....
	Models with Multileaf Spring	F1HT-18045-DA	OO	83312	89409	OO	....	....	....
90-97	Models with 52" Taperleaf Spring	F1HT-18045-GB F1HT-18045-GA	OO	85006	....	OO	....	....	....
	Models with 58" Parabolic Taperleaf Spring	F1HT-18045-RA F1HT-18045-RB	OO	....	89402	OO	....	....	....

### L9000

94-97	Models with 21000 or 23000 lb. with 46" Taperleaf Spring	F4HT-18080-BA		....	....	OO	85001	89410	....
91-97	Models with 4000, 4500, 5400, 6000, 7200 lb Multileaf Springs and with 9000, 10000, 12000 or 16000 lb Axles	F1HT-18045-CB	OO	83216	....	OO	....	....	....
	Models with 4500, 5400, 6000, 7200, 10000 lb Multileaf Springs and with 10000, 12000, 13200, 16000 lb Axles	F1HT-18045-DB	OO	83308	....	OO	....	....	....
	Models with 52" Taperleaf Spring	F1HT-18045-GB F1HT-18045-GA	OO	85006	....	OO	....	....	....
	Models with 58" Parabolic Taperleaf Spring	F1HT-18045-RA F1HT-18045-RB	OO	....	89402	OO	....	....	....
	Models with Multileaf Spring	F1HT-18045-DA	OO	83312	89409	OO	....	....	....
81-97	Models with 7000, 9000, 12000 lb Axles	D7HF-18045-FA D2EF-18045-AA D2KF-18045-AA D7HT-18045-BA	OO	83312	89409	OO	....	....	....
81-90	Models with 7000, 9000, 12000, 16000 lb Axles	D2HF-18045-BA D7HT-18045-DA	OO	83309	....	OO	....	....	....
81-85	Models with 7000, 9000, 12000, 16000 lb Axles	D2HT-18045-CA D2HF-18045-AA	OO	83314	....	OO	....	....	....

### LA8000F

91-97	All with Hendrickson HAS-400, HA-210 or HA-230 Air Suspension	47902-28		....	....	OO	85013	89414	....	
		Models with 4000, 4500, 5400, 6000, or 7200 lb. Multileaf Spring	F1HT-18045-CB	OO	83216	....	OO	....	....	....
		Models with 52" or 58" Taperleaf Spring	F1HT-18045-EA F1HT-18045-EB	OO	....	89402	OO	....	....	....
		Models with with 4500 lb to 10000 lb Multileaf Spring	F1HT-18045-CA	OO	83308	....	OO	....	....	....
96	Models with 12000 or 13000 lb Axles	F6HT-18045-LA	OO	85376	....	OO	....	....	....	
	Models with 16000 lb. Multileaf Spring	F6HT-18045-AA	OO	85054	....	OO	....	....	....	

### LA9000

91-97	All with Hendrickson HAS-400, HA-210 or HA-230 Air Suspension	47902-28		....	....	OO	85013	89414	....
		Models with 4000, 4500, 5400, 6000, or 7200 lb. Multileaf Spring	F1HT-18045-CB	OO	83216	....	OO	....	....
90-97	Models with with 4500 lb to 10000 lb Multileaf Spring	F1HT-18045-CA	OO	83308	....	OO	....	....	....

### LL, LLA, LTA, LTL, LTLA - CONVENTIONAL CAB

93	LL-9000 with 4500, 5000, 6000 lb Springs and with 10000, 11000, 12000 lb Axles 83000 Series	F1HT-18045-DB		83308	....		....	....	....
----	---	---------------	--	-------	------	--	------	------	------

# APPLICATION GUIDE

Year	Fitment Notes	OEM#					
			Fleetline	GasSLX	Fleetline	GasSLX	Cab Shock/ Specialty Shock

## FORD

## FORD

### LL9000

94-96	Models with 4000, 4500, 5400, 6000 or 7200 lb Multileaf Springs and with 9000, 10000, 12000 or 16000 lb Axles	F1HT-18045-CB	O	O	83216	....	....	....	....
	Models with 4500, 5000, 6000 lb Springs and with 10000, 11000, 12000 lb Axles	F1HT-18045-DB	O	O	83308	....	....	....	....
91-92	Models with 4000, 4500, 5400, 6000 or 7200 lb Multileaf Springs and with 9000, 10000, 12000 or 16000 lb Axles	F1HT-18045-CB	O	O	83216	....	....	....	....
90-92	Models with 4500, 5000, 6000 lb Springs and with 10000, 11000, 12000 lb Axles	F1HT-18045-DB	O	O	83308	....	....	....	....

### LLA9000

92-97	Models with 4000, 4500, 5400, 6000 or 7200 lb Multileaf Springs and with 9000, 10000, 12000 or 16000 lb Axles	F1HT-18045-CB	O	O	83216	....	....	....	....
	Models With 4500, 5400, 6000, 7200 or 10000 lb. Multileaf Spring	F1HT-18045-CA	O	O	83308	....	....	....	....
	Models with 4500, 5400, 6500 lb 58" Parabolic Taperleaf Spring	F0HT-18045-CA F1HT-18045-HB	O	O	85006	....	....	....	....
	Models with Hendrickson Rear Air Suspension	47902-28	O	O	....	....	85013	89414	....

### LN & LNT - CONVENTIONAL CAB

	LN-7000, LN-8000, LN-9000, LNT-8000, LNT-9000 with Hendrickson Rear Air Suspension 83000 Series	F0HT-18080-AA 47902-13 F0HZ-18125-A	O	O	....	....	83122	....	....
	LN-7000, LN-8000, LN-9000, LNT-8000, LNT-9000 with Hendrickson Rear Air Suspension 89000 Series	F0HT-18080-AA 47902-13 F0HZ-18125-A	O	O	....	....	....	89406	....
86-89	LN-600, LN-700, LN-750 with 11000, 13000, 15000, 17000 lb. Axles 83000 Series	D7HT-18080-BA	O	O	....	....	83225	....	....
70-89	LN-600, LN-650, LN-700, LN-750, LN-7000, LN-800, LN-8000, LNT-800, LNT-8000 with 3000, 3300 lb. Springs and 5000, 5500, 6000, 7000 lb. Axles 83000 Series	D7HT-18045-GA	O	O	83308	....	....	....	....
	LN-600, LN-700, LN-7000, LN-800, LN-8000, LNT-800, LNT-8000 with 4400 lb. Spring and 7000, 9000 lb. Axles 83000 Series	D2EF-18045-AA	O	O	83312	....	....	....	....
	LN-600, LN-700, LN-7000, LN-800, LN-8000, LNT-800, LNT-8000 with 4400 lb. Spring and 7000, 9000 lb. Axles 89000 Series	D2EF-18045-AA	O	O	....	89409	....	....	....
76-81	LN-800, LN-8000, LN-900, LN-9000, LNT-800, LNT-8000, LNT-900, LNT-9000 83000 Series	D7HT-18045-CA D2HF-18045-AA	O	O	83314	....	....	....	....
76-79	LN-600, LN-650, LN-700, LN-800 83000 Series	D7HT-18045-BA	O	O	83312	....	....	....	....
	LN-600, LN-650, LN-700, LN-800 89000 Series	D7HT-18045-BA	O	O	....	89409	....	....	....
70-79	LN-800, LN-850, LN-8000, LN-900, LN-9000, LNT-800, LNT-850, LNT-880, LNT-8000, LNT-900, LNT-9000 with 6000, 7000, 9000, 12000, 16000 lb. Axles 83000 Series	D2HF-18045-BA D7HT-18045-DA	O	O	83309	....	....	....	....
76-77	LN-800, LN-8000, LN-900, LN-9000, LNT-800, LNT-8000, LNT-900, LNT-9000 83000 Series	D2KF-18045-AA	O	O	83312	....	....	....	....
	LN-800, LN-8000, LN-900, LN-9000, LNT-800, LNT-8000, LNT-900, LNT-9000 89000 Series	D2KF-18045-AA	O	O	....	89409	....	....	....
70-75	LN-700, LN-750 Diesel with 9000 lb. Axle 83000 Series	C1TT-18045-C	O	O	83312	....	....	....	....
	LN-700, LN-750 Diesel with 9000 lb. Axle 89000 Series	C1TT-18045-C	O	O	....	89409	....	....	....
70-71	LN-800, LN-850, LNT-900, with 7000, 9000, 12000 lb. Axles 83000 Series	D2TF-18045-GA	O	O	83308	....	....	....	....

### LN700

80-86	Models with 11000, 13000, 15000, 17000 lb Axles	D7HT-18080-BA	O	O	....	....	83225	....	....
	Models with 3000, 3300 lb Springs and 5000, 5500, 6000, 7000 lb Axles	D7HT-18045-GA	O	O	83308	....	....	....	....
	Models with 4400 lb Spring and 7000, 9000 lb Axles	D2EF-18045-AA	O	O	83312	89409	....	....	....

### LN800

80-85	Models with 3000, 3300 lb Springs and 5000, 5500, 6000, 7000 lb Axles	D7HT-18045-GA	O	O	83308	....	....	....	....
	Models with 4400 lb Spring and 7000, 9000 lb Axles	D2EF-18045-AA	O	O	83312	89409	....	....	....
	Models with 6000, 7000, 9000, 12000, 16000 lb Axles	D2HF-18045-BA D7HT-18045-DA	O	O	83309	....	....	....	....

### LN900

81	Models with 6000, 7000, 9000, 12000, 16000 lb Axles	D2HF-18045-BA D7HT-18045-DA	O	O	83309	....	....	....	....
----	---	--------------------------------	---	---	-------	------	------	------	------



# APPLICATION GUIDE

Year	Fitment Notes	OEM#					
				Fleetline	GasSLX		Fleetline

## FORD

## FORD

### LN7000

94-97	Models with 21000 or 23000 lb. with 46" Taperleaf Spring	F4HT-18080-BA		....									
91-97	Models with 4000, 4500, 5400, 6000 or 7200 lb Multileaf Springs and with 9000, 10000, 12000 or 16000 lb Axles	F1HT-18045-CB	<input type="checkbox"/>	83216	....	<input type="checkbox"/>	85001	89410	....	....	....	....	....
	Models with 4500, 5400, 6000, 7200, 10000 lb Springs and with 10000, 12000, 13200, 16000 lb Axles	F1HT-18045-DB	<input type="checkbox"/>	83308	....	<input type="checkbox"/>	....	....	....	....	....	....	....
90-97	Models with 52" Taperleaf Spring	F1HT-18045-GB F1HT-18045-GA	<input type="checkbox"/>	85006	....	<input type="checkbox"/>	....	....	....	....	....	....	....
	Models with 58" Parabolic Taperleaf Spring	F1HT-18045-RA F1HT-18045-RB	<input type="checkbox"/>	....	89402	<input type="checkbox"/>	....	....	....	....	....	....	....
	Models with Multileaf Spring	F1HT-18045-DA	<input type="checkbox"/>	83312	89409	<input type="checkbox"/>	....	....	....	....	....	....	....
81-97	Models with 3000, 3300 lb Springs and 5000, 5500, 6000, 7000 lb Axles	D7HT-18045-GA	<input type="checkbox"/>	83308	....	<input type="checkbox"/>	....	....	....	....	....	....	....
	Models with 4400 lb Spring and 7000, 9000 lb Axles	D2EF-18045-AA	<input type="checkbox"/>	83312	89409	<input type="checkbox"/>	....	....	....	....	....	....	....

### LN8000

94-97	Models with 21000 or 23000 lb. with 46" Taperleaf Spring	F4HT-18080-BA		....									
91-97	Models with 4000, 4500, 5400, 6000 or 7200 lb Multileaf Springs and with 9000, 10000, 12000 or 16000 lb Axles	F1HT-18045-CB	<input type="checkbox"/>	83216	....	<input type="checkbox"/>	85001	89410	....	....	....	....	....
	Models with 4500, 5400, 6000, 7200, 10000 lb Springs and with 10000, 12000, 13200, 16000 lb Axles	F1HT-18045-DB	<input type="checkbox"/>	83308	....	<input type="checkbox"/>	....	....	....	....	....	....	....
90-97	Models with 52" Taperleaf Spring	F1HT-18045-GB F1HT-18045-GA	<input type="checkbox"/>	85006	....	<input type="checkbox"/>	....	....	....	....	....	....	....
	Models with 58" Parabolic Taperleaf Spring	F1HT-18045-RA F1HT-18045-RB	<input type="checkbox"/>	....	89402	<input type="checkbox"/>	....	....	....	....	....	....	....
	Models with Multileaf Spring	F1HT-18045-DA	<input type="checkbox"/>	83312	89409	<input type="checkbox"/>	....	....	....	....	....	....	....
81-97	Models with 3000, 3300 lb Springs and 5000, 5500, 6000, 7000 lb Axles	D7HT-18045-GA	<input type="checkbox"/>	83308	....	<input type="checkbox"/>	....	....	....	....	....	....	....
	Models with 4400 lb Spring and 7000, 9000 lb Axles	D2EF-18045-AA	<input type="checkbox"/>	83312	89409	<input type="checkbox"/>	....	....	....	....	....	....	....
81-88	Models with 6000, 7000, 9000, 12000, 16000 lb Axles	D2HF-18045-BA D7HT-18045-DA	<input type="checkbox"/>	83309	....	<input type="checkbox"/>	....	....	....	....	....	....	....

### LN9000

94-97	Models with 21000 or 23000 lb. with 46" Taperleaf Spring	F4HT-18080-BA		....									
91-97	Models with 4000, 4500, 5400, 6000 or 7200 lb Multileaf Springs and with 9000, 10000, 12000 or 16000 lb Axles	F1HT-18045-CB	<input type="checkbox"/>	83216	....	<input type="checkbox"/>	85001	89410	....	....	....	....	....
	Models with 4500, 5400, 6000, 7200, 10000 lb Springs and with 10000, 12000, 13200, 16000 lb Axles	F1HT-18045-DB	<input type="checkbox"/>	83308	....	<input type="checkbox"/>	....	....	....	....	....	....	....
90-97	Models with 52" Taperleaf Spring	F1HT-18045-GB F1HT-18045-GA	<input type="checkbox"/>	85006	....	<input type="checkbox"/>	....	....	....	....	....	....	....
	Models with 58" Parabolic Taperleaf Spring	F1HT-18045-RA F1HT-18045-RB	<input type="checkbox"/>	....	89402	<input type="checkbox"/>	....	....	....	....	....	....	....
	Models with Multileaf Spring	F1HT-18045-DA	<input type="checkbox"/>	83312	89409	<input type="checkbox"/>	....	....	....	....	....	....	....
81-89	Models with 6000, 7000, 9000, 12000, 16000 lb Axles	D2HF-18045-BA D7HT-18045-DA	<input type="checkbox"/>	83309	....	<input type="checkbox"/>	....	....	....	....	....	....	....

### LNT800

81-84	Models with 3000, 3300 lb Springs and 5000, 5500, 6000, 7000 lb Axles	D7HT-18045-GA		83308									
	Models with 4400 lb Spring and 7000, 9000 lb Axles	D2EF-18045-AA	<input type="checkbox"/>	83312	89409	<input type="checkbox"/>	....	....	....	....	....	....	....
	Models with 6000, 7000, 9000, 12000, 16000 lb Axles	D2HF-18045-BA D7HT-18045-DA	<input type="checkbox"/>	83309	....	<input type="checkbox"/>	....	....	....	....	....	....	....

### LNT900

81	Models with 6000, 7000, 9000, 12000, 16000 lb Axles	D2HF-18045-BA D7HT-18045-DA		83309									
----	---	--------------------------------	--	-------	--	--	--	--	--	--	--	--	--

### LNT8000

81-89	Models with 3000, 3300 lb Springs and 5000, 5500, 6000, 7000 lb Axles	D7HT-18045-GA		83308									
	Models with 4400 lb Spring and 7000, 9000 lb Axles	D2EF-18045-AA	<input type="checkbox"/>	83312	89409	<input type="checkbox"/>	....	....	....	....	....	....	....
	Models with 6000, 7000, 9000, 12000, 16000 lb Axles	D2HF-18045-BA D7HT-18045-DA	<input type="checkbox"/>	83309	....	<input type="checkbox"/>	....	....	....	....	....	....	....

# APPLICATION GUIDE

Year	Fitment Notes	OEM#					
			Fleetline	GasSLX	Fleetline	GasSLX	Cab Shock/ Specialty Shock

## FORD

## FORD

### LNT8000F

94-97	Models with 21000 or 23000 lb. with 46" Taperleaf Spring	F4HT-18080-BA		....	....		85001	89410	....
91-97	Models with 4000, 4500, 5400, 6000 or 7200 lb Multileaf Springs and with 9000, 10000, 12000 or 16000 lb Axles	F1HT-18045-CB	O	O	83216	....	....	....	....
	Models with 4500, 5400, 6000, 7200, 10000 lb Springs and with 10000, 12000, 13200, 16000 lb Axles	F1HT-18045-DB	O	O	83308	....	....	....	....
90-97	Models with 52" Taperleaf Spring	F1HT-18045-GB F1HT-18045-GA	O	O	85006	....	....	....	....
	Models with 58" Parabolic Taperleaf Spring	F1HT-18045-RA F1HT-18045-RB	O	O	....	89402	....	....	....
	Models with Multileaf Spring	F1HT-18045-DA	O	O	83312	89409	....	....	....
87-97	Models with 3000, 3300 lb Springs and 5000, 5500, 6000, 7000 lb Axles	D7HT-18045-GA	O	O	83308	....	....	....	....

### LNT9000

94-97	Models with 21000 or 23000 lb. with 46" Taperleaf Spring	F4HT-18080-BA		....	....		85001	89410	....
91-97	Models with 4000, 4500, 5400, 6000 or 7200 lb Multileaf Springs and with 9000, 10000, 12000 or 16000 lb Axles	F1HT-18045-CB	O	O	83216	....	....	....	....
	Models with 4500, 5400, 6000, 7200, 10000 lb Springs and with 10000, 12000, 13200, 16000 lb Axles	F1HT-18045-DB	O	O	83308	....	....	....	....
90-97	Models with 52" Taperleaf Spring	F1HT-18045-GB F1HT-18045-GA	O	O	85006	....	....	....	....
	Models with 58" Parabolic Taperleaf Spring	F1HT-18045-RA F1HT-18045-RB	O	O	....	89402	....	....	....
	Models with Multileaf Spring	F1HT-18045-DA	O	O	83312	89409	....	....	....
81-89	Models with 6000, 7000, 9000, 12000, 16000 lb Axles	D2HF-18045-BA D7HT-18045-DA	O	O	83309	....	....	....	....

### LOUISVILLE SERIES - CONVENTIONAL CAB

	All with 54" Multileaf Spring and with 12000 or 13200 lb Axle 85000 Series	F6HT-18045-BC	O	O	85047	....	....	....	....
	All with 54" Multileaf Spring and with 12000 or 13200 lb Axle 89000 Series	F6HT-18045-BC	O	O	....	89435	....	....	....
	All with Hendrickson HAS-400 Air Suspension 85000 Series	F6HZ-18080-FC 47902-28 F6HZ-18125-D	O	O	....	....	85013	....	....
	All with Hendrickson HAS-400 Air Suspension 89000 Series	F6HZ-18080-FC 47902-28 F6HZ-18125-D	O	O	....	....	....	89414	....
	All with Neway AD-246 Air Suspension 85000 Series	90045099	O	O	....	....	85906	....	....
		90045132	O	O	....	....	85909	....	....
All with Neway AD-246 Air Suspension 89000 Series	90045099	O	O	....	....	....	89407	....	
96-98	All with 13200 lb or 14600 lb Axle and 54" Taperleaf Spring 85000 Series	F6HT-18045-GC F6HT-18045-GB	O	O	85030	....	....	....	....
	All with 13200 lb or 14600 lb Axle and 54" Taperleaf Spring 89000 Series	F6HT-18045-GC F6HT-18045-GB	O	O	....	89440	....	....	....
	All with 54" Multi-leaf Spring and 14600 or 16000 lb Axle 85000 Series	F6HT-18045-CC F6HZ-18124-C	O	O	85055	....	....	....	....
	All with 54" Multi-leaf Spring and 14600 or 16000 lb Axle 89000 Series	F6HT-18045-CC F6HZ-18124-C	O	O	....	89439	....	....	....
96-97	All Models with 10000 lb or 12000 lb Axle and 54" Taperleaf Spring 85000 Series	F6HT-18045-AC F6HZ-18124-A F6HZ-18124-G	O	O	85054	....	....	....	....
	All with 12000 lb, 13000 lb or 14600 lb Axle and 60" Taperleaf Spring 85000 Series	F6HT-18045-EB F6HT-18045-EC F6HZ-18124-F F6HZ-18124-E F6HZ-18124-D	O	O	85055	....	....	....	....
	All with 12000 lb, 13000 lb or 14600 lb Axle and 60" Taperleaf Spring 89000 Series	F6HT-18045-EB F6HT-18045-EC F6HZ-18124-F F6HZ-18124-E F6HZ-18124-D	O	O	....	89439	....	....	....
	All with 54" Multileaf Spring and with 8500 or 9000 lb Axle 89000 Series	F6HT-18045-JB F6HT-18045-JC F6HZ-18124-J	O	O	....	89402	....	....	....
	All with 8500 lb or 9000 lb Axle with 54" Taperleaf Spring 85000 Series	F6HT-18045-HB F6HT-18045-HC F6HZ-18124-H	O	O	85054	....	....	....	....

# APPLICATION GUIDE

Year	Fitment Notes	OEM#					
			Fleetline	GasSLX	Fleetline	GasSLX	Cab Shock\ Specialty Shock

## FORD

## FORD

### LS8000F

90-97	Models with 52" or 58" Taperleaf Spring	F1HT-18045-EA F1HT-18045-EB	O	O	....	89402	....	....	....
	Models with with 4500 lb to 10000 lb Multileaf Spring	F1HT-18045-CA	O	O	83308	....	....	....	....

### LT800

81-84	Models with 7000, 9000, 12000 lb Axles	D7HF-18045-FA D2EF-18045-AA D2KF-18045-AA D7HT-18045-BA	O	O	83312	89409	....	....	....
	Models with 7000, 9000, 12000, 16000 lb Axles	D2HF-18045-BA D7HT-18045-DA	O	O	83309	....	....	....	....
		D2HT-18045-CA D2HF-18045-AA	O	O	83314	....	....	....	....

### LT8000

81-88	Models with 7000, 9000, 12000 lb Axles	D7HF-18045-FA D2EF-18045-AA D2KF-18045-AA D7HT-18045-BA	O	O	83312	89409	....	....	....
	Models with 7000, 9000, 12000, 16000 lb Axles	D2HF-18045-BA D7HT-18045-DA	O	O	83309	....	....	....	....
81-85	Models with 7000, 9000, 12000, 16000 lb Axles	D2HT-18045-CA D2HF-18045-AA	O	O	83314	....	....	....	....

### LT9000

94-97	Models with 21000 or 23000 lb. with 46" Taperleaf Spring	F4HT-18080-BA	O	O	....	....	85001	89410	....
91-97	Models with 4000, 4500, 5400, 6000, 7200 lb Multileaf Springs and with 9000, 10000, 12000 or 16000 lb Axles	F1HT-18045-CB	O	O	83216	....	....	....	....
	Models with 4500, 5400, 6000, 7200, 10000 lb Multileaf Springs and with 10000, 12000, 13200, 16000 lb Axles	F1HT-18045-DB	O	O	83308	....	....	....	....
	Models with 52" Taperleaf Spring	F1HT-18045-GB F1HT-18045-GA	O	O	85006	....	....	....	....
	Models with 58" Parabolic Taperleaf Spring	F1HT-18045-RA F1HT-18045-RB	O	O	....	89402	....	....	....
	Models with Multileaf Spring	F1HT-18045-DA	O	O	83312	89409	....	....	....
81-97	Models with 7000, 9000, 12000 lb Axles	D7HF-18045-FA D2EF-18045-AA D2KF-18045-AA D7HT-18045-BA	O	O	83312	89409	....	....	....
81-90	Models with 7000, 9000, 12000, 16000 lb Axles	D2HF-18045-BA D7HT-18045-DA	O	O	83309	....	....	....	....
81-85	Models with 7000, 9000, 12000, 16000 lb Axles	D2HT-18045-CA D2HF-18045-AA	O	O	83314	....	....	....	....

### LTA9000

91-97	Models with 4000, 4500, 5400, 6000 or 7200 lb Multileaf Springs and with 9000, 10000, 12000 or 16000 lb Axles	F1HT-18045-CB	O	O	83216	....	....	....	....
	Models With 4500, 5400, 6000, 7200 or 10000 lb. Multileaf Spring	F1HT-18045-CA	O	O	83308	....	....	....	....
	Models with Hendrickson Rear Air Suspension	47902-28	O	O	....	....	85013	89414	....

### LTL9000

82-85	Models with 7000, 9000, 12000 lb. Axle	D2HF-18045-AA	O	O	83314	....	....	....	....
-------	--	---------------	---	---	-------	------	------	------	------

### LTLA9000

92-97	Models with 4000, 4500, 5400, 6000 or 7200 lb Multileaf Springs and with 9000, 10000, 12000 or 16000 lb Axles	F1HT-18045-CB	O	O	83216	....	....	....	....
	Models With 4500, 5400, 6000, 7200 or 10000 lb. Multileaf Spring	F1HT-18045-CA	O	O	83308	....	....	....	....
	Models with 4500, 5400, 6500 lb 58" Parabolic Taperleaf Spring	F0HT-18045-CA F1HT-18045-HB	O	O	85006	....	....	....	....
	Models with Hendrickson Rear Air Suspension	47902-28	O	O	....	....	85013	89414	....

### LTS9000

81-90	Models with 7000, 9000, 12000, 16000 lb Axles	D2HF-18045-BA D7HT-18045-DA	O	O	83309	....	....	....	....
81-89	Models with 16000 lb Axle	D0HA-18045-E D2HF-18045-DA D7HT-18045-EA	O	O	83312	89409	....	....	....

# APPLICATION GUIDE

Year	Fitment Notes	OEM#					
			Fleetline	GasSLX	Fleetline	GasSLX	Cab Shock Specialty Shock

## FORD

## FORD

### LTS9000 (cont)

81-85	Models with 7000, 9000, 12000, 16000 lb Axles	D2HT-18045-CA D2HF-18045-AA	O O	83314	....					
-------	---	--------------------------------	--------	-------	------	--	--	--	--	--

### MOTORHOME CHASSIS

73-76	M-400 & M-500 Motorhome Chassis 83000 Series	.....								
	M-400 & M-500 Motorhome Chassis 85000 Series	.....	O O	85012	....					
	M-400 & M-500 Motorhome Chassis 89000 Series	.....	O O	....	89413	....				
57-76	P-400 & 4000 Motorhome Chassis with H.D. Springs 85000 Series	.....	O O	85012	....					
	P-400 & 4000 Motorhome Chassis with H.D. Springs 89000 Series	.....	O O	....	89413	....				

### N AND NT 89" BBC CONVENTIONAL CAB

64-69	M-750, N-800, N-850, N-900, N-950 with 6000, 7000, 9000, 11000, 12000 lb. Axles 83000 Series	C1TT-18045-C		83312	....					
	M-750, N-800, N-850, N-900, N-950 with 6000, 7000, 9000, 11000, 12000 lb. Axles 89000 Series	C1TT-18045-C	O O	....	89409	....				
	N-1100 with 11000 thru 15000 lb. Axles 83000 Series	C6PF-18077-DN	O O	83314	....	....				
	N-500, N-550, N-600, N-650, N-700 with 5000, 6000, 7000 & 9000 lb. Axles 83000 Series	D2TF-18045-GA	O O	83308	....	....				
	N-500, N-550, N-600, N-650, N-700, N-750 83000 Series	D2TF-18080-HA C7PF-18077-A	O O	....	....	....				
	N-600, N-650, N-700, N-750, N-800, N-850, N-900, N-950 with 6000, 7000, 9000, 11000, 12000 lb. Axles 83000 Series	C6PF-18077-DL	O O	83312	....	....				
	N-600, N-650, N-700, N-750, N-800, N-850, N-900, N-950 with 6000, 7000, 9000, 11000, 12000 lb. Axles 89000 Series	C6PF-18077-DL	O O	....	89409	....				

### T-SERIES - CONVENTIONAL TANDEM

64-69	T-750, T-800, T-850, T-900, T-950 with 9000 thru 15000 lb. Axles 83000 Series	C6PF-18077-DN C1TT-18045-E		83314	....					
-------	---	-------------------------------	--	-------	------	--	--	--	--	--

### VARIOUS

	HN-80 with 21000 lb or 23000 lb Axle & 52" Taper leaf Rear Suspension 85000 Series	F6HT-18080-JA		....	....					
--	--	---------------	--	------	------	--	--	--	--	--

### W AND WT SERIES - HI TILT CAB HIGHWAY TRACTOR

73-77	W-900, WT-900 with Air Suspension 83000 Series	D2HZ-18080-A D4HA-18080-AA								
	W-900, WT-900 with Air Suspension 89000 Series	D2HZ-18080-A D4HA-18080-AA	O O	....	....	....	89414	....		
66-77	W-900, W-950, W-1000, WT-900, WT-950, WT-1000 with 12000 & 15000 lb. Axle 85000 Series	C6TA-18045-Z C6TA-18045-Y	O O	85301	....					
66-71	W-900, W-950, W-1000, WT-900, WT-950, WT-1000 with 11000 lb. Axle 85000 Series	D2HA-18045-E1A D2HA-18045-E2B D2HA-18045-E1B D2HA-18045-E2A	O O	85304	....					

## FOREST RIVER

## FOREST RIVER

### CLASS A MOTORHOMES

	MotorHomes with Workhorse UFO Chassis with Hendrickson Softek Front Suspension 83000 Series	66153-002 F4-BE5-C832-MO		83124	....					
	MotorHomes with Workhorse UFO Chassis with Hendrickson Softek Front Suspension 89000 Series	66153-002 F4-BE5-C832-MO	O O	....	89407	....				

### REFLECTION

02-04	MotorHomes with Freightliner XC Chassis & ADL200 Suspension w/ 20K Rear ADL200 Suspension w/ 20K Rear 85000 Series	16-16873-000								
	MotorHomes with Freightliner XC Chassis & ADL200 Suspension w/ 20K Rear Rear Shock with O.E.M. Number 85000 Series	141700131809 16-16736-000	O O	....	....	....	85029	....		
	MotorHomes with Freightliner XC Chassis and AS120 Front Suspension 83000 Series	16-16874-000 16-16737-000 141700131810	O O	83160	....	....				
	MotorHomes with Freightliner XC ChassisZF & IFS Front Suspension with 23,000 lb GVW or Greater ZF - IFS Front Suspension with 23,000 lb GVW or Greater 85000 Series	16-18103-000 481700000493	O O	85900	....	....				

### TSUNAMI

02-06	MotorHomes with Freightliner XC Chassis & ADL200 Suspension w/ 20K Rear ADL200 Suspension w/ 20K Rear 85000 Series	16-16873-000		....	....					
-------	--	--------------	--	------	------	--	--	--	--	--

# APPLICATION GUIDE

Year	Fitment Notes	OEM#					
			Fleetline	GasSLX	Fleetline	GasSLX	Cab Shock\ Specialty Shock

## FOREST RIVER

## FOREST RIVER

### TSUNAMI (cont)

02-06	MotorHomes with Freightliner XC Chassis & ADL200 Suspension w/ 20K Rear Rear Shock with O.E.M. Number 85000 Series	141700131809 16-16736-000	...	...	OO	85029	...	...
	MotorHomes with Freightliner XC Chassis and AS120 Front Suspension 83000 Series	16-16874-000 16-16737-000 141700131810	OO	83160	...	...	...	...
	MotorHomes with Freightliner XC ChassisZF & IFS Front Suspension with 23,000 lb GVW or Greater ZF - IFS Front Suspension with 23,000 lb GVW or Greater 85000 Series	16-18103-000 481700000493	I	85900	...	...	...	...

## FREIGHTLINER

## FREIGHTLINER

### 108SD

12-24	All Models with 12,000 to 16,000 lb. Front Axle and Taperleaf Spring	10-13760-000 471700002991 SDA471700002991	OO	85959	...	...	...	...
	Day Cab Models with Spring Suspensions	18-47350-000 18-60766-000 814903003482	OO	...	...	...	83040	...
	Models with FAS II (40,000 lb) Rear Air Suspension	16-15817-000 16-18708-000 481700006848 471700002809 SDA471700002809	OO	...	...	85724	89443	...
	Models with Freightliner TufTrac Rear Air Suspension	481700125969 16-15770-000	OO	...	...	85956	...	...
	Models with Hendrickson HMX 400/460 Haulmax with 16.5" Saddle	60680-004L 60680-004 H60680-004	OO	...	...	83143	...	...
	Models with Hendrickson HMX 400/460 Haulmax with 17.5" & 18.5" Saddle	60680-005L HDR60680-005 60680-005	OO	...	...	83142	...	...

### 114SD

12-24	All Models with 12000 lb to 20000 lb Set-Back Front Axle	SDA471700003920 10-13809-000	OO	85958	...	...	...	...
	Day Cab Models with Spring Suspensions	18-47350-000 18-60766-000 814903003482	OO	...	...	...	83040	...
	Models with FAS II (40,000 lb) Rear Air Suspension	16-15817-000 16-18708-000 481700006848 471700002809 SDA471700002809	OO	...	...	85724	89443	...
	Models with Freightliner TufTrac Rear Air Suspension	481700125969 16-15770-000	OO	...	...	85956	...	...
	Models with Hendrickson HMX 400/460 Haulmax with 16.5" Saddle	HDR60680-004 60680-004L 60680-004 H60680-004	OO	...	...	83143	...	...
	Models with Hendrickson HMX 400/460 Haulmax with 17.5" & 18.5" Saddle	60680-005L HDR60680-005 60680-005	OO	...	...	83142	...	...
12-23	All Models with 18,000 lb Flat Leaf Spring	10-13684-000 471700000470	OO	85918	89449	...	...	...

### 122SD

17-23	Models with O.E.M. Number	814903015188 18-69674-000	OO	...	...	...	83906	...
13-23	All Models with 12000 lb to 20000 lb Set-Back Front Axle	SDA471700003920 10-13809-000	OO	85958	...	...	...	...
	Models with FAS II (40,000 lb) Rear Air Suspension	16-15817-000 16-18708-000 481700006848 471700002809 SDA471700002809	OO	...	...	85724	89443	...
	Models with Freightliner TufTrac Rear Air Suspension	481700125969 16-15770-000	OO	...	...	85956	...	...
	Models with Hendrickson HMX 400/460 Haulmax with 16.5" Saddle	60680-004L 60680-004 H60680-004	OO	...	...	83143	...	...
	Models with Hendrickson HMX 400/460 Haulmax with 17.5" & 18.5" Saddle	60680-005L HDR60680-005 60680-005	OO	...	...	83142	...	...
13-16	Crew Cab Models with O.E.M. Number	18-60764-000	OO	...	...	...	83038	...
	Models with O.E.M. Number	18-60764-000	OO	...	...	...	83038	...

# APPLICATION GUIDE

Year	Fitment Notes	OEM#					
			Fleetline	GasSLX	Fleetline	GasSLX	Cab Shock Specialty Shock

## FREIGHTLINER

## FREIGHTLINER

### ADDITIONAL APPLICATIONS

	Models with 60" Sleeper w/ Link Bunkmate Model FRTS60-A 83000 Series	1202-1043	....	....	O	....	....	83025
--	--	-----------	------	------	---	------	------	-------

### ARGOSY

99-15	Models with 12000 lb Taperleaf Front Suspension	10-13634-000 47170000449 10-12703-000	O	85918	89449	....	....	....
	Models with FAS II (40,000 lb) Rear Air Suspension	16-15817-000 16-13957-000	O	....	....	O	85724	89443
	Models with Freightliner Low Profile Rear Air Suspension (18,000 to 40,000 lb)	16-14259-000 471700002992 16-18706-000	O	....	....	O	85331	....
	Models with O.E.M. Number	18-37813-000	O	....	....	O	....	83044
	Models with Rear 10000 lb - 15000 lb Low Profile AirLiner	16-18711-000 16-16577-000 471700002996	O	....	....	O	85335	....

### B2

05-23	Models with 12000 lb Taperleaf Front Suspension	10-13634-000 10-13211-000	O	85918	89449	....	....	....
	Models with FAS II (40,000 lb) Rear Air Suspension	16-15817-000 16-13957-000 16-18708-000 481700006848 471700002809 SDA471700002809	O	....	....	O	85724	89443
05-22	Models with 15,000 lb Rear Suspension	6803260000	O	....	....	O	83120	....

### BUS CHASSIS

	FB Shuttle bus chassis with O.E.M. Number 85000 Series	16-16765-000 471700131775	O	85006	....	....	....	....
	School Bus Chassis with 7,000 lb Suspension 85000 Series	471700005079 10-13859-000	O	85005	....	....	....	....
	School Bus Chassis with 7,000 lb Suspension 89000 Series	471700005079 10-13859-000	O	....	89430	....	....	....
	Shuttle Bus Chassis 85000 Series	16-16082-000	O	85043	....	....	....	....
97-08	F65 School bus chassis with 10,000 to 18,000 lb Suspension 85000 Series	6803230300 471700003009 10-13759-000 GBL665538	O	85006	....	....	....	....
	F65 School bus chassis with Taperleaf Spring 83000 Series	6803260000 GBL654725	O	....	....	O	83120	....

### CASCADIA

21-24	Cascadia 126 Day Cab and Sleeper cabs w/ 12 mm Top mounting bolt	18-73207-000 814903018451	....	....	....	O	....	83911
18-24	126 Models with 12000 to 13300 lb Taperleaf Front Suspension	10-14317-000 10-14282-000 X9007009-73 10-14193-000 A90193 10-14339-000	O	83396	....	....	....	....
	Models with Hendrickson Airtek NXT Front	HDR 58913 015 58913-015	O	85200	....	....	....	....
16-24	Models with Airliner Rear Air Suspension with O.E.M. Number	16-20156-000	O	....	....	O	85205	....
08-24	Models with FAS II (40,000 lb) Rear Air Suspension	16-15817-000 16-18708-000 481700006848 471700002809 SDA471700002809	O	....	....	O	85724	89443
09-22	Models with Hendrickson Front Airtek	58913-003L 58913-012L 471700131331 471700006269 58913-012 58913-003	O	85932	89453	....	....	....
18-21	116 Models with 12000 to 13300 lb Taperleaf Front Suspension	10-14317-000 10-14282-000 X9007009-73 10-14193-000 A90193	O	83396	....	....	....	....

# APPLICATION GUIDE

Year	Fitment Notes	OEM#					
			Fleetline	GasSLX	Fleetline	GasSLX	Cab Shock\ Specialty Shock

## FREIGHTLINER

### CASCADIA (cont)

17-21	Day Cab and Sleeper cabs w/OEM Number and 12 mm Top mounting bolt	814903012666 814903015188 18-67845-000 18-69674-000	OIO	85918	89449	OIO		83906
18-20	113 Models with 12000 to 13300 lb Taperleaf Front Suspension	10-14317-000 10-14282-000 X9007009-73 10-14193-000 A90193	OIO	83396	...	OIO	...	...
09-20	125 Models with 12000 to 13300 lb Taperleaf Front Suspension	SDA471700003920 10-13809-000	OIO	85958	...	OIO	...	...
09-19	Models with 72" High-Roof Sleeper and 1/2" Top mounting bolt	18-41762-000 814903003528 18-60764-000	OIO	...	...	OIO	...	83038
09-17	113 Models with 12000 to 13300 lb Taperleaf Front Suspension	SDA471700003920 10-13809-000	OIO	85958	...	OIO	...	...
08	125 Models with 12000 to 13300 lb Taperleaf Front Suspension	10-13634-000 47170000449 10-13211-000 471700131155	OIO	85918	89449	OIO	...	...

## FREIGHTLINER

### CENTURY CLASS

	Models with Low Profile Front 85000 Series	10-12703-000	OIO	85918	...	OIO		...
	Models with Low Profile Front 89000 Series	10-12703-000	OIO	...	89449	OIO	...	...
	Models with O.E.M. Number 83000 Series	18-41762-000 18-41762-002	OIO	...	...	OIO	...	83038
		18-41762-001	OIO	...	...	OIO	...	83047
00-11	Models with 12000 lb Taperleaf Front Suspension	10-13634-000 47170000449 10-13063-000 10-13021-000 10-13211-000 471700131155	OIO	85918	89449	OIO	...	...
	Models with Hendrickson Front Airtek	58913-003L 471700131331 58913-003	OIO	85932	89453	OIO	...	...
96-11	Day Cab Suspensions with O.E.M. Number	18-32999-001 18-60295-000 18-30378-000	OIO	...	...	OIO	...	83006
	Models with FAS II (40,000 lb) Rear Air Suspension	16-15817-000 16-13957-000	OIO	...	...	OIO	85724	89443
	Models with Freightliner Low Profile Rear Air Suspension (18,000 to 40,000 lb)	16-14259-000 471700002992 16-18706-000	OIO	...	...	OIO	85331	...
	Sleeper-Cabs with O.E. Number	18-30378-000 18-32999-000	OIO	...	...	OIO	...	83001
97-99	Models with 12000 lb Taperleaf Front Suspension	10-12542-000	OIO	85901	...	OIO	...	...

### CLASSIC

01-11	Models with 12000 lb Taperleaf Front Suspension	10-13634-000 47170000449 10-13063-000 10-13021-000 10-13211-000 471700131155	OIO	85918	89449	OIO		...
	Models with FAS II (40,000 lb) Rear Air Suspension	16-15817-000 16-13957-000 16-18708-000 481700006848 471700002809 SDA471700002809	OIO	...	...	OIO	85724	89443
	Models with Hendrickson Front Airtek	58913-003L 471700131331 58913-003	OIO	85932	89453	OIO	...	...
	Sleeper Cab models with Air Suspension	18-29846-000	OIO	...	...	OIO	...	83009

### CLASSIC XL

01-09	Models with 12000 lb Taperleaf Front Suspension	10-13634-000 47170000449 10-13063-000 10-13021-000 10-13211-000 471700131155	OIO	85918	89449	OIO		...
-------	---	---	-----	-------	-------	-----	--	-----



# APPLICATION GUIDE

Year	Fitment Notes	OEM#					
			Fleetline	GasSLX	Fleetline	GasSLX	Cab Shock Specialty Shock

## FREIGHTLINER

### CLASSIC XL (cont)

01-09	Models with FAS II (40,000 lb) Rear Air Suspension	16-15817-000 16-13957-000 16-18708-000 481700006848 471700002809 SDA471700002809	...	...	85724	89443	...
	Models with Hendrickson Front Airtek	58913-003L 471700131331 58913-003	OO	85932	89453	...	...

## FREIGHTLINER

### CLASSIC/CLASSICXL

	Models with O.E.M. Number 85000 Series	680009	OO	85302	...	...	...	
		70029	OO	85308	...	...	...	
		10-12032-004 10-12032-002	OO	85320	...	...	...	
		Models with O.E.M. Number 89000 Series	680009	OO	...	89420	...	...
			70029	OO	...	89422	...	...
			10-12032-004 10-12032-002	OO	...	89429	...	...

### COLUMBIA

	Models with O.E.M. Number 83000 Series	18-29846-000	OO	...	...	...	83009
17-20	Models with Sleeper Cabs w/O.E.M. Numbers	814903015188 18-69674-000	OO	...	...	...	83906
09-20	Models with 12000 lb Taperleaf Front Suspension	SDA471700003920 10-13809-000	OO	85958	...	...	...
00-20	All Models with Freightliner TufTrac Rear Air Suspension	481700125969 16-15770-000	OO	...	...	85956	...
	Models with FAS II (40,000 lb) Rear Air Suspension	16-15817-000 471700002808 16-18708-000 481700006848 471700002809 SDA471700002809	OO	...	...	85724	89443
	Models with Hendrickson Front Airtek	58913-003L 58913-012L 471700131331 471700006269 58913-012 58913-003	OO	85932	89453	...	...
00-17	Models with Sleeper Cabs w/O.E.M. Numbers	18-41762-000 814903003528 18-60764-000	OO	...	...	...	83038
00-08	Models with 12000 lb Taperleaf Front Suspension	10-13634-000 471700000449 10-13063-000 10-13021-000 10-13684-000 471700000470 10-13211-000 471700131155	OO	85918	89449	...	...

### CONDOR

02-07	Models with Hendrickson HMX 400/460 Haulmax with 16.5" Saddle	60680-004L 60680-004 H60680-004	OO	...	...	83143	...
	Models with Hendrickson HMX 400/460 Haulmax with 17.5" & 18.5" Saddle	60680-005L HDR60680-005 60680-005	OO	...	...	83142	...
01-07	Models with 14,600 to 20,000 lb Front Suspension	10-13634-000 471700000449 10-13211-000 471700131155	OO	85918	89449	...	...
	Models with Chalmers 46,000 lb Rear Suspension	665174	OO	...	...	85060	...
	Models with FAS II (40,000 lb) Rear Air Suspension	16-15817-000 16-13957-000 16-18708-000 481700006848 471700002809 SDA471700002809	OO	...	...	85724	89443
	Models with Freightliner TufTrac Rear Air Suspension	481700125969 16-15770-000	OO	...	...	85956	...



# APPLICATION GUIDE

Year	Fitment Notes	OEM#					
			Fleetline	GasSLX	Fleetline	GasSLX	Cab Shock\ Specialty Shock

## FREIGHTLINER CORONADO

## FREIGHTLINER

17-20	Day Cab and Sleeper Cabs w/O.E.M. Numbers	814903015188 18-69674-000						
10-20	Models with 12,000 lb to 20,000 Front Axle	10-13809-000 471700003920	OO	85958	....	....	....	....
01-20	Models with Chalmers 46,000 lb Rear Suspension	665174	OO	....	....	85060	....	....
	Models with FAS II (40,000 lb) Rear Air Suspension	16-15817-000 16-18708-000 481700006848 471700002809 SDA471700002809	OO	....	....	85724	89443	....
	Models with Freightliner TufTrac Rear Air Suspension	481700125969 16-15770-000	OO	....	....	85956	....	....
	Models with Hendrickson Front Airtek	58913-003L 58913-012L 471700131331 471700006269 58913-012 58913-003	OO	85932	89453	....	....	....
01-17	Models with Sleeper Cabs w/O.E.M. Numbers	18-41762-000 18-41762-002 814903003528 18-60764-000 18-60765-002	OO	....	....	....	....	83038
01-09	Models with 12000 lb Taperleaf Front Suspension	10-13211-000	OO	85918	89449	....	....	....

## FC70

05-07	Models with 10,000 to 18,000 lb Suspension 85000 Series	6803230300 471700003009 10-13759-000 GBL665538						
	Models with 6000 to 9000 lb Front Axle 85000 Series	6803230200	OO	85043	....	....	....	....
	Models with Freightliner FAS II Rear Air Suspension 85000 Series	16-15817-000 16-13957-000	OO	....	....	85724	....	....
	Models with Freightliner FAS II Rear Air Suspension 89000 Series	16-15817-000 16-13957-000	OO	....	....	....	89443	....
99-04	Models with 10,000 to 18,000 lb Suspension	6803230300 471700003009 10-13759-000 GBL665538	OO	85006	....	....	....	....
	Models with 6000 to 9000 lb Front axle	6803230200	OO	85043	....	....	....	....
	Models with FAS II (40,000 lb) Rear Air Suspension	16-15817-000 16-13957-000 16-18708-000	OO	....	....	85724	89443	....







## FC80

99-07	Models with 10,000 to 18,000 lb Suspension	6803230300 471700003009 10-13759-000 GBL665538						
	Models with 6000 to 9000 lb Front axle	6803230200	OO	85043	....	....	....	....
	Models with FAS II (40,000 lb) Rear Air Suspension	16-15817-000 16-13957-000 16-18708-000	OO	....	....	85724	89443	....

## FL70

96-06	Day Cab Suspensions with O.E.M. Number	18-32999-001 18-60295-000 18-30378-000						
91-06	Models with 10,000 to 18,000 lb Suspension	6803230300 471700003009 10-13759-000 GBL665538	OO	85006	....	....	....	....
	Models with 6000 to 9000 lb Front axle	6803230200	OO	85043	....	....	....	....
	Models with FAS II (40,000 lb) Rear Air Suspension	16-15817-000 16-13957-000	OO	....	....	85724	89443	....
	Trucks with Link Cabmate Models FRT153BC-A , FRT106BC or FRT106HD-A	1201-0054 1202-0054	OO	....	....	....	....	83021
	w/ 15000 lb Rear Suspension	6803260000 GBL654725	OO	....	....	83120	....	....







# APPLICATION GUIDE

Year	Fitment Notes	OEM#					
			 Fleetline	 GasSLX	 Fleetline	 GasSLX	 Cab Shock Specialty Shock

## FREIGHTLINER

## FREIGHTLINER

### FL80

96-06	Day Cab Suspensions with O.E.M. Number	18-32999-001 18-60295-000 18-30378-000	....	....		....	....	83006
91-06	Models with 10,000 to 18,000 lb Suspension	6803230300 471700003009 10-13759-000 GBL665538		85006	....	....	....	....
	Models with 6000 to 9000 lb Front axle	6803230200		85043	....	....	....	....
	Models with FAS II (40,000 lb) Rear Air Suspension	16-15817-000 16-13957-000	....	....		85724	89443	....
	Trucks with Link Cabmate Models FRT153BC-A , FRT106BC or FRT106HD-A	1201-0054 1202-0054	....	....		....	....	83021
	w/ 15000 lb Rear Suspension	6803260000 GBL654725	....	....		83120	....	....







### FL106

94-03	Trucks with Link Cabmate Models FRT153BC-A , FRT106BC or FRT106HD-A	1201-0054 1202-0054	....	....		....	....	83021
-------	---	------------------------	------	------	---	------	------	-------











### FL112

96-06	Day Cab Tractors with Link Cabmate Model FRT112DC	1201-1044 1202-1044	....	....		....	....	83025
-------	---	------------------------	------	------	---	------	------	-------

### FLA086

89-99	Models with 86", 96" & 104" Cabs with Link Cabmate Model FRT285	1202-0032	....	....		....	....	83016
	Models with Airliner Rolling Lobe Spring Air Suspension	16-13947-000 681-326-0400	....	....		85319	89428	....
	Models with Convoluted Spring Air Suspension	16-18705-000 471700002990 16-12117-000	....	....		85007	....	....
	Models with FAS II (40,000 lb) Rear Air Suspension	16-15817-000 16-13957-000	....	....		85724	89443	....
	Models with Neway Tag Axle Air Suspension	90044162	....	....		83128	89436	....
	Models with O.E.M. Number	10-12032-004 10-12032-003 10-12032-002 10-12032-001 10-12032-000 10-12030-002	....	85320	89429	....	....	....
	681-891-02-05 GBL 650361	....	....		....	....	83017	

### FLB

02	Models with 86", 96" & 104" Cabs with Link Cabmate Model FRT285	1202-0032	....	....		....	....	83016
	Models with Airliner Rolling Lobe Spring Air Suspension	16-13947-000 681-326-0400	....	....		85319	89428	....
	Models with Convoluted Spring Air Suspension	16-18705-000 471700002990 16-12117-000	....	....		85007	....	....
	Models with FAS II (40,000 lb) Rear Air Suspension	16-15817-000 16-13957-000	....	....		85724	89443	....
	Models with Neway Tag Axle Air Suspension	90044162	....	....		83128	89436	....
	Trucks with 90", 100", & 110" Cabs with Link Cabmate Models FRT46-2P-A or FRT46-2P-B	1201-0054 1202-0054	....	....		....	....	83021
94-99	Models with 86", 96" & 104" Cabs with Link Cabmate Model FRT285	1202-0032	....	....		....	....	83016
	Models with Airliner Rolling Lobe Spring Air Suspension	16-13947-000 681-326-0400	....	....		85319	89428	....
	Models with Convoluted Spring Air Suspension	16-18705-000 471700002990 16-12117-000	....	....		85007	....	....
	Models with FAS II (40,000 lb) Rear Air Suspension	16-15817-000 16-13957-000	....	....		85724	89443	....
	Models with Neway Tag Axle Air Suspension	90044162	....	....		83128	89436	....
	Models with O.E.M. Number	10-12032-004 10-12032-003 10-12032-002 10-12032-001 10-12032-000 10-12030-002	....	85320	89429	....	....	....

# APPLICATION GUIDE

Year	Fitment Notes	OEM#					
			Fleetline	GasSLX	Fleetline	GasSLX	Cab Shock\ Specialty Shock

## FREIGHTLINER

## FREIGHTLINER

### FLB (cont)

94-99	Trucks with 90", 100", & 110" Cabs with Link Cabmate Models FRT46-2P-A or FRT46-2P-B	1201-0054 1202-0054	....	....	O	O	....	....	83021
-------	--	------------------------	------	------	---	---	------	------	-------

### FLC112

95-01	Models with 12000 lb Taperleaf Front Suspension	10-13634-000 47170000449 10-13063-000 10-13021-000 10-13211-000 471700131155	O	85918	89449	O	O	....	....	....
	Models with FAS II (40,000 lb) Rear Air Suspension	16-15817-000 16-13957-000	O	....	....	O	O	85724	89443	....
89-01	Conventional Tractors with Link Cabmate Model FRTE120-A	1201-1043 1202-1043	O	....	....	O	O	....	....	83025
85-01	Models with Convulated Spring Air Suspension	16-18705-000 471700002990 16-12117-000	O	....	....	O	O	85007	....	....
85-97	Models with O.E.M. Number	10-12032-004 10-12032-003 10-12032-002 10-12032-001 10-12032-000 10-12030-002	O	85320	89429	O	O	....	....	....

### FLC120

91	Conventional Tractors with Link Cabmate Model FRTE120-A	1201-1043 1202-1043	O	....	....	O	O	....	....	83025
	Models with Convulated Spring Air Suspension	16-18705-000 471700002990 16-12117-000	O	....	....	O	O	85007	....	....
	Models with O.E.M. Number	10-12032-004 10-12032-003 10-12032-002 10-12032-001 10-12032-000 10-12030-002	O	85320	89429	O	O	....	....	....
87-88	Models with O.E.M. Number	10-12032-004 10-12032-003 10-12032-002 10-12032-001 10-12032-000 10-12030-002	O	85320	89429	O	O	....	....	....
81-88	Models with Convulated Spring Air Suspension	16-18705-000 471700002990 16-12117-000	O	....	....	O	O	85007	....	....

### FLD112

03-08	D2 Cab Models	814903003486 18-41762-001 18-60765-001	O	....	....	O	O	....	....	83047
02-08	Models with Hendrickson Front Airtak	58913-003L 58913-012L 471700131331 471700006269 58913-012 58913-003	O	85932	89453	O	O	....	....	....
95-08	Models with 12000 lb Taperleaf Front Suspension	10-13634-000 47170000449 10-13063-000 10-13021-000 10-13211-000 471700131155	O	85918	89449	O	O	....	....	....
	Models with FAS II (40,000 lb) Rear Air Suspension	16-15817-000 16-13957-000	O	....	....	O	O	85724	89443	....
91-08	Models with Convulated Spring Air Suspension	16-18705-000 471700002990 16-12117-000	O	....	....	O	O	85007	....	....
	Models with O.E.M. Number	10-12032-004 10-12032-003 10-12032-002 10-12032-001 10-12032-000 10-12030-002	O	85320	89429	O	O	....	....	....
		1201-1043 1201-1044 1202-1043 1202-1044	O	....	....	O	O	....	....	83025
		Sleeper Cab models with Air Suspension	18-29846-000	O	....	....	O	O	....	....

# APPLICATION GUIDE

Year	Fitment Notes	OEM#					
			Fleetline	GasSLX	Fleetline	GasSLX	Cab Shock/ Specialty Shock

## FREIGHTLINER

### FLD112 (cont)

08	All Models with Freightliner TufTrac Rear Air Suspension	481700125969 16-15770-000	....	....	85956	....	....
----	--	------------------------------	------	------	-------	------	------

## FREIGHTLINER

### FLD120

09-11	Models with 12000 to 13300 lb Taperleaf Front Suspension	SDA471700003920 10-13809-000	O	85958	....	....	....
08-11	All Models with Freightliner TufTrac Rear Air Suspension	481700125969 16-15770-000	O	....	....	85956	....
03-11	D2 Cab Models	814903003486 18-41762-001 18-60765-001	O	....	....	....	83047
02-11	Models with Hendrickson Front Airtek	58913-003L 58913-012L 471700131331 471700006269 58913-012 58913-003	O	85932	89453	....	....
95-11	Models with FAS II (40,000 lb) Rear Air Suspension	16-15817-000 16-13957-000	O	....	....	85724	89443
91-11	Sleeper Cab models with Air Suspension	18-29846-000	O	....	....	....	83009
88-11	Models with Convoluted Spring Air Suspension	16-18705-000 471700002990 16-12117-000	O	....	....	85007	....
	Models with O.E.M. Number	10-12032-004 10-12032-003 10-12032-002 10-12032-001 10-12032-000 10-12030-002	O	85320	89429	....	....
		1201-1043 1201-1044 1202-1043 1202-1044	O	....	....	....	83025
		95-08	Models with 12000 lb Taperleaf Front Suspension	10-13634-000 47170000449 10-13063-000 10-13021-000 10-13211-000 471700131155	O	85918	89449

### FLD120SD

09-12	Models with 12000 to 13300 lb Taperleaf Front Suspension	SDA471700003920 10-13809-000	O	85958	....	....	....
08-12	All Models with Freightliner TufTrac Rear Air Suspension	481700125969 16-15770-000	O	....	....	85956	....
05-12	Models with Convoluted Spring Air Suspension	16-18705-000 471700002990 16-12117-000	O	....	....	85007	....
	Models with FAS II (40,000 lb) Rear Air Suspension	16-15817-000 16-13957-000	O	....	....	85724	89443
	Models with Hendrickson Front Airtek	58913-003L 58913-012L 471700131331 471700006269 58913-012 58913-003	O	85932	89453	....	....
	Models with O.E.M. Number	10-12032-004 10-12032-003 10-12032-002 10-12032-001 10-12032-000 10-12030-002	O	85320	89429	....	....
05-08	Models with 12000 lb Taperleaf Front Suspension	10-13634-000 47170000449 10-13063-000 10-13021-000 10-13211-000 471700131155	O	85918	89449	....	....
03	Models with 12000 lb Taperleaf Front Suspension	10-13634-000 47170000449 10-13063-000 10-13021-000 10-13211-000 471700131155	O	85918	89449	....	....
	Models with Convoluted Spring Air Suspension	16-18705-000 471700002990 16-12117-000	O	....	....	85007	....
	Models with FAS II (40,000 lb) Rear Air Suspension	16-15817-000 16-13957-000	O	....	....	85724	89443

# APPLICATION GUIDE

Year	Fitment Notes	OEM#					
			Fleetline	GasSLX	Fleetline	GasSLX	Cab Shock Specialty Shock

## FREIGHTLINER

### FLD120SD (cont)

03	Models with Hendrickson Front Airtek	58913-003L 58913-012L 471700131331 471700006269 58913-012 58913-003	OIO	85932	89453	....	....	....
	Models with O.E.M. Number	10-12032-004 10-12032-003 10-12032-002 10-12032-001 10-12032-000 10-12030-002	OIO	85320	89429	....	....	....

## FREIGHTLINER

### FLD132

09-11	Models with 12000 to 13300 lb Taperleaf Front Suspension	SDA471700003920 10-13809-000	OIO	85958	....	....	....	....
08-11	All Models with Freightliner TufTrac Rear Air Suspension	481700125969 16-15770-000	OIO	....	....	85956	....	....
03-11	Models with Convoluted Spring Air Suspension	16-18705-000 471700002990 16-12117-000	OIO	....	....	85007	....	....
	Models with FAS II (40,000 lb) Rear Air Suspension	16-15817-000 16-13957-000	OIO	....	....	85724	89443	....
	Models with Hendrickson Front Airtek	58913-003L 58913-012L 471700131331 471700006269 58913-012 58913-003	OIO	85932	89453	....	....	....
	Models with O.E.M. Number	10-12032-004 10-12032-003 10-12032-002 10-12032-001 10-12032-000 10-12030-002	OIO	85320	89429	....	....	....
05-08	Models with 12000 lb Taperleaf Front Suspension	10-13634-000 471700000449 10-13063-000 10-13021-000 10-13211-000 471700131155	OIO	85918	89449	....	....	....
01	Models with Convoluted Spring Air Suspension	16-18705-000 471700002990 16-12117-000	OIO	....	....	85007	....	....
	Models with FAS II (40,000 lb) Rear Air Suspension	16-15817-000 16-13957-000	OIO	....	....	85724	89443	....
	Models with O.E.M. Number	10-12032-004 10-12032-003 10-12032-002 10-12032-001 10-12032-000 10-12030-002	OIO	85320	89429	....	....	....

### FRED CHASSIS

06-08	Front - Engine Diesel Chassis (FRED Chassis) 85000 Series	471700002726 16-18455-000	OIO	85918	....	....	....	....
	Front - Engine Diesel Chassis (FRED Chassis) 89000 Series	471700002726 16-18455-000	OIO	....	89449	....	....	....

### M2

	Models O.E.M. Number 85000 Series	10-13592-000 471700000440	OIO	85959	....	....	....	....
05-21	Models with FAS II (40,000 lb) Rear Air Suspension	16-15817-000 16-18708-000 481700006848 471700002809 SDA471700002809	OIO	....	....	85724	89443	....
	Models with Freightliner TufTrac Rear Air Suspension	481700125969 16-15770-000	OIO	....	....	85956	....	....
	Models with Hendrickson HMX 400/460 Haulmax with 16.5" Saddle	60680-004L 60680-004 H60680-004	OIO	....	....	83143	....	....
	Models with Hendrickson HMX 400/460 Haulmax with 17.5" & 18.5" Saddle	60680-005L HDR60680-005 60680-005	OIO	....	....	83142	....	....
	Models with Rear 10000 lb - 15000 lb Low Profile AirLiner	16-18711-000 16-16577-000 471700002996	OIO	....	....	85335	....	....

# APPLICATION GUIDE

Year	Fitment Notes	OEM#					
			Fleetline	GasSLX	Fleetline	GasSLX	Cab Shock/ Specialty Shock

## FREIGHTLINER

### M2 (cont)

05-21	Models with Rear 52" Spring ,10000 lb - 15000 lb	16-16486-000 16-18710-000 471700002995	....	....	 ○	83134	....	....
	Models with Rear 52" Spring ,18000 lb - 23000 lb	471700002994 16-16442-000 16-18709-000	....	....	 ○	83134	....	....
	Models with Rear 60" Spring ,18000 lb - 23000 lb	16-15765-000 471700002993 16-18707-000	....	....	 ○	85921	....	....
05-15	Models with Freightliner Low Profile Rear Air Suspension (18,000 to 40,000 lb)	16-14259-000 471700002992 16-18706-000	....	....	 ○	85331	....	....

## FREIGHTLINER

### M2 100

02-10	Models with FAS II (40,000 lb) Rear Air Suspension	16-15817-000 16-18708-000 481700006848 471700002809 SDA471700002809	....	....	 ○ ○	85724	89443	....
	Models with Freightliner Low Profile Rear Air Suspension (18,000 to 40,000 lb)	16-14259-000 471700002992 16-18706-000	....	....	 ○ ○	85331	....	....
	Models with Freightliner TufTrac Rear Air Suspension	481700125969 16-15770-000	....	....	 ○ ○	85956	....	....
	Models with Hendrickson HMX 400/460 Haulmax with 16.5" Saddle	60680-004L 60680-004 H60680-004	....	....	 ○ 	83143	....	....
	Models with Hendrickson HMX 400/460 Haulmax with 17.5" & 18.5" Saddle	60680-005L HDR60680-005 60680-005	....	....	 ○ 	83142	....	....
	Models with Rear 10000 lb - 15000 lb Low Profile AirLiner	16-18711-000 16-16577-000 471700002996	....	....	 ○ ○	85335	....	....
	Models with Rear 52" Spring ,10000 lb - 15000 lb	16-16486-000 16-18710-000 471700002995	....	....	 ○ ○	83134	....	....
	Models with Rear 52" Spring ,18000 lb - 23000 lb	471700002994 16-16442-000 16-18709-000	....	....	 ○ ○	83134	....	....
	Models with Rear 60" Spring ,18000 lb - 23000 lb	16-15765-000 471700002993 16-18707-000	....	....	 ○ ○	85921	....	....

### M2 106

05-06	Day Cab Models with Spring Suspensions	18-47350-000 18-60766-000 814903003482	....	....	 ○ ○	....	....	83040
	Models with 10000 to 12000 lb. Taper-leaf Spring Suspension	10-12390-000	 ○ ○	85920	89503	 ○ ○	....	....
	Models with 6000 to 9000 lb Front axle	10-12388-000	 ○ ○	85920	89503	 ○ ○	....	....
	Models with FAS II (40,000 lb) Rear Air Suspension	16-15817-000 16-18708-000 481700006848 471700002809 SDA471700002809	....	....	 ○ ○	85724	89443	....
	Models with Freightliner Low Profile Rear Air Suspension (18,000 to 40,000 lb)	16-14259-000 471700002992 16-18706-000	....	....	 ○ ○	85331	....	....
	Models with Freightliner TufTrac Rear Air Suspension	481700125969 16-15770-000	....	....	 ○ ○	85956	....	....
	Models with Hendrickson HMX 400/460 Haulmax with 16.5" Saddle	60680-004L 60680-004 H60680-004	....	....	 ○ 	83143	....	....
	Models with Hendrickson HMX 400/460 Haulmax with 17.5" & 18.5" Saddle	60680-005L HDR60680-005 60680-005	....	....	 ○ 	83142	....	....
	Models with Rear 10000 lb - 15000 lb Low Profile AirLiner	16-18711-000 16-16577-000 471700002996	....	....	 ○ ○	85335	....	....
	Models with Rear 52" Spring ,10000 lb - 15000 lb	16-16486-000 16-18710-000 471700002995	....	....	 ○ ○	83134	....	....
Models with Rear 52" Spring ,18000 lb - 23000 lb	471700002994 16-16442-000 16-18709-000	....	....	 ○ ○	83134	....	....	

# APPLICATION GUIDE

Year	Fitment Notes	OEM#					
			Fleetline	GasSLX	Fleetline	GasSLX	Cab Shock Specialty Shock

## FREIGHTLINER

## FREIGHTLINER

### M2 106 (cont)

05-06	Models with Rear 60" Spring ,18000 lb - 23000 lb	16-15765-000 471700002993 16-18707-000	....	....		85921	....	....
	Models with Reyco 79KB Rear Steel Spring Suspension	19495-01 16725-01	....	....		83126	89430	....
02-03	Day Cab Models with Spring Suspensions	18-47350-000 18-60766-000 814903003482	....	....		....	....	83040
	Models with 10000 to 12000 lb. Taper-leaf Spring Suspension	10-12390-000		85920		89503	....	....
	Models with 6000 to 9000 lb Front axle	10-12388-000		85920		89503	....	....
	Models with FAS II (40,000 lb) Rear Air Suspension	16-15817-000 16-18708-000 481700006848 471700002809 SDA471700002809	....	....		85724	89443	....
	Models with Freightliner Low Profile Rear Air Suspension (18,000 to 40,000 lb)	16-14259-000 471700002992 16-18706-000	....	....		85331	....	....
	Models with Freightliner TufTrac Rear Air Suspension	481700125969 16-15770-000	....	....		85956	....	....
	Models with Hendrickson HMX 400/460 Haulmax with 16.5" Saddle	60680-004L 60680-004 H60680-004	....	....		83143	....	....
	Models with Hendrickson HMX 400/460 Haulmax with 17.5" & 18.5" Saddle	60680-005L HDR60680-005 60680-005	....	....		83142	....	....
	Models with Rear 10000 lb - 15000 lb Low Profile AirLiner	16-18711-000 16-16577-000 471700002996	....	....		85335	....	....
	Models with Rear 52" Spring ,10000 lb - 15000 lb	16-16486-000 16-18710-000 471700002995	....	....		83134	....	....
	Models with Rear 52" Spring ,18000 lb - 23000 lb	471700002994 16-16442-000 16-18709-000	....	....		83134	....	....
	Models with Rear 60" Spring ,18000 lb - 23000 lb	16-15765-000 471700002993 16-18707-000	....	....		85921	....	....
Models with Reyco 79KB Rear Steel Spring Suspension	19495-01 16725-01	....	....		83126	89430	....	

### M2 112

16-24	Models with Airliner Rear Air Suspension with O.E.M. Number	16-20156-000	....	....		85205	....	....
09-24	Models with 12000 lb to 20000 Front Axle	10-13809-000 471700003920		85958		....	....	....
03-24	Day Cab Models with Leaf Spring Suspensions	18-47349-000 814903003483 18-60767-000	....	....		....	....	83039
	Models with FAS II (40,000 lb) Rear Air Suspension	16-15817-000 16-18708-000 481700006848 471700002809 SDA471700002809	....	....		85724	89443	....
	Models with Freightliner TufTrac Rear Air Suspension	481700125969 16-15770-000	....	....		85956	....	....
	Models with Hendrickson HMX 400/460 Haulmax with 16.5" Saddle	60680-004L 60680-004 H60680-004	....	....		83143	....	....
	Models with Hendrickson HMX 400/460 Haulmax with 17.5" & 18.5" Saddle	60680-005L HDR60680-005 60680-005	....	....		83142	....	....
03-23	Models with Rear 10000 lb - 15000 lb Low Profile AirLiner	16-18711-000 16-16577-000 471700002996	....	....		85335	....	....
	Models with Rear 52" Spring ,10000 lb - 15000 lb	16-16486-000 16-18710-000 471700002995	....	....		83134	....	....
	Models with Rear 52" Spring ,18000 lb - 23000 lb	471700002994 16-16442-000 16-18709-000	....	....		83134	....	....
	Models with Rear 60" Spring ,18000 lb - 23000 lb	16-15765-000 471700002993 16-18707-000	....	....		85921	....	....

# APPLICATION GUIDE

Year	Fitment Notes	OEM#					
			Fleetline	GasSLX	Fleetline	GasSLX	Cab Shock Specialty Shock

## FREIGHTLINER

### M2 112 (cont)

03-22	Crew Cab Models with O.E.M. Number	18-41762-000 814903003528 18-60764-000	....	....	OO	....	....	83038
03-15	Models with Freightliner Low Profile Rear Air Suspension (18,000 to 40,000 lb)	16-14259-000 471700002992 16-18706-000	....	....	OO	85331	....	....
03-08	Models with 12000 lb to 20000 Front Axle	10-13634-000 471700000449 10-13211-000 471700131155 10-12703-000	OO	85918	89449	....	....	....

## FREIGHTLINER

### MB CHASSIS

	MB Chassis (VIP bus) 85000 Series	16-17760-000 471700131778 16-16827-000	....	....	OO	85331	....	....
	MB55 Chassis 85000 Series	16-17759-000 471700000447	....	....	OO	85919	....	....
	MB55 Models w/8000 lb. flat leaf front suspension 85000 Series	16-17684-000	OO	85058	....	....	....	....
	MB55 Models w/8000 lb. flat leaf front suspension 89000 Series	16-17684-000	OO	....	89431	....	....	....
	MB55 Shuttle bus w/8000 lb. flat leaf front suspension 85000 Series	16-15676-000	OO	85058	....	....	....	....
	MB55 Shuttle bus w/8000 lb. flat leaf front suspension 89000 Series	16-15676-000	OO	....	89431	....	....	....

### MC CHASSIS

	MC Chassis with Hendrickson Softek Front Suspension 85000 Series	16-18094-000 471700000466	OO	85959	....	....	....	....
	MC Chassis with O.E.M. Number 85000 Series	471700002727 16-18456-000	OO	....	....	OO	85959	....
	MC-L Chassis with 9,000 lb Suspension 85000 Series	471700002726 16-18455-000	OO	85918	....	....	....	....
	MC-L Chassis with 9,000 lb Suspension 89000 Series	471700002726 16-18455-000	OO	....	89449	....	....	....
96-99	MC Chassis for Class A Motorhomes 83000 Series	P117099	OO	....	....	OO	83120	....

### MP 14

	MP 14 Chassis 83000 Series	16-15475-000	OO	83164	....	....	....	....
--	----------------------------	--------------	----	-------	------	------	------	------

### MP 19

	MP 19 Chassis 83000 Series	16-15475-000	OO	83164	....	....	....	....
--	----------------------------	--------------	----	-------	------	------	------	------

### MT55

	MT55 Models w/8000 lb. flat leaf front suspension 85000 Series	16-17684-000 16-15676-000	OO	85058	....	....	....	....
	MT55 Models w/8000 lb. flat leaf front suspension 89000 Series	16-17684-000 16-15676-000	OO	....	89431	....	....	....
	MT55 Step Van with O.E.M. Number To 2020 83000 Series	16-16542-000 16-15436-000	OO	....	....	OO	83154	....

### VARIOUS

	Fleetwood Motor Home with O.E.M. Number 83000 Series	GBL 651375 RW24285	OO	83119	....	....	....	....
	M-Line Walk in Van with O.E.M. Number 83000 Series	P117099 MAE 16949	OO	....	....	OO	83120	....
	Models with 7000 lb Front Suspension 85000 Series	10-13776-000	OO	85005	....	....	....	....
	Models with 7000 lb Front Suspension 89000 Series	10-13776-000	OO	....	89430	....	....	....
	Models with Neway Air Suspension with shock stamping 85000 Series	90045083	OO	....	....	OO	85910	....
	Oshkosh Motor Home with O.E.M. Number 83000 Series	1398980	OO	83127	....	....	....	....
	Step Van Models with O.E.M. Number 85000 Series	471700003011 16-19138-000	OO	85058	....	....	....	....
	Step Van Models with O.E.M. Number 89000 Series	471700003011 16-19138-000	OO	....	89431	....	....	....
18-24	Models with Freightliner S2RV chassis 85000 Series	10-13976-000 16-16764-000	OO	85918	....	....	....	....
			OO	....	....	OO	85724	....



# APPLICATION GUIDE

Year	Fitment Notes	OEM#					
			Fleetline	GasSLX	Fleetline	GasSLX	Cab Shock\ Specialty Shock

## FREIGHTLINER

## FREIGHTLINER

### VARIOUS (cont)

18-24	Models with Freightliner S2RV chassis 89000 Series	10-13976-000	O	....	89449	O	....	....
		16-16764-000	O	....	....	O	....	89443

### VC CHASSIS

03-12	VC Chassis - ADL200 Suspension w/ 23,000 lb GVW & Higher 85000 Series	141700131809	O	....	....	O	85029	....	....
		16-16736-000	O	....	....	O	....	....	....
03-07	MotorHome Chassis with ZF - IFS Front Suspension (23,000 lb GVW & Higher) 85000 Series	16-18103-000	I	85900	....	O	....	....	....
		48170000493	I	....	....	O	85029	....	....
	VC Chassis - ADL200 Suspension w/ 20K Rear 85000 Series	16-16873-000	O	....	....	O	....	....	....
		471700131974	O	....	....	O	....	....	....
93-07	VC Chassis - Neway AS-120 Front Air Suspension (Up To 22000 lb GVW) 83000 Series	16-16737-000	O	83160	....	O	....	....	....

### XB CHASSIS

	MotorHome Chassis with Neway AS-120, 10,500 lb Front Air Suspension 83000 Series	14170000377	O	83160	....	O	....	....
		16-18075-000	O	....	....	O	....	....
	MotorHome Chassis with Neway AS-120, 12,000 lb Front Air Suspension 83000 Series	16-16874-000	O	83160	....	O	....	....
		14170000378	O	....	....	O	....	....
		16-18076-000	O	....	....	O	....	....
		141700131975	O	....	....	O	....	....

### XC CHASSIS

	MotorHome Chassis with Neway AS-120, 10,500 lb Front Air Suspension 83000 Series	14170000377	O	83160	....	O	....	....
		16-18075-000	O	....	....	O	....	....
		16-16874-000	O	83160	....	O	....	....
	MotorHome Chassis with Neway AS-120, 12,000 lb Front Air Suspension 83000 Series	14170000378	O	....	....	O	....	....
		16-18076-000	O	....	....	O	....	....
		141700131975	O	....	....	O	....	....
	MotorHome Chassis with ZF- IFS, 12,000 lb Front Air Suspension 85000 Series	16-17144-000	I	85900	....	O	....	....
		48170000477	I	....	....	O	....	....
		481700131919	I	....	....	O	....	....
		16-17361-000	I	....	....	O	....	....
03-12	MotorHome Chassis with Neway AS-120 Front Air Suspension (23,000 lb GVW & Higher) 83000 Series	16-16874-000	O	83160	....	O	....	....
		16-16737-000	O	....	....	O	....	....
		141700131810	O	....	....	O	....	....
	XC Chassis - ADL200 Suspension w/ 23,000 lb GVW & Higher 85000 Series	141700131809	O	....	....	O	85029	....
		16-16736-000	O	....	....	O	....	....
03-07	MotorHome Chassis with ZF - IFS Front Suspension (23,000 lb GVW & Higher) 85000 Series	16-18103-000	I	85900	....	O	....	....
		48170000493	I	....	....	O	....	....
	XC Chassis - ADL200 Suspension w/ 20K Rear 85000 Series	16-16873-000	O	....	....	O	85029	....
		471700131974	O	....	....	O	....	....
93-07	MotorHome Chassis with Neway AS-120 Front Air Suspension (Up To 22000 lb GVW) 83000 Series	16-16737-000	O	83160	....	O	....	....

### XCS CHASSIS

01-02	XCS Chassis with Freightliner Rear Air Suspension 83000 Series	16-16093-000	O	83160	....	O	....	....
00-02	XCS Chassis (22000 lb GVW) w/ O.E.M. Number 83000 Series	16-15592-000	O	....	....	O	83154	....
		16-15755-000	O	....	....	O	....	....
	XCS Chassis (22000 lb GVW) w/ O.E.M. Number 85000 Series	16-16043-000	O	85043	....	O	....	....

## FRUEHAUF

## FRUEHAUF

### VARIOUS

	"L" Suspensions 83000 Series	UCD-006216-001	O	....	....	O	83203	....	....	
		"L" Suspensions 89000 Series	UCD-006216-001	O	....	....	O	....	89436	....
		"T" Suspensions 85000 Series	UCE-1295-901	O	....	....	O	....	85300	....
		"T" Suspensions 89000 Series	UCE-1295-901	O	....	....	O	....	89419	....
		"T" Suspensions With Drop Frame ( NT Construction ) 85000 Series	UCF-8339-001	O	....	....	O	....	85321	....
			UCF-8339-002	O	....	....	O	....	....	....
		All with Air Suspension and O.E.M. Number 85000 Series	UCE-1295-1	O	....	....	O	....	85300	....
		All with Air Suspension and O.E.M. Number 89000 Series	UCE-1295-1	O	....	....	O	....	....	89419
		All with Lift Axle 83000 Series	UCE-9399-1	O	....	....	O	....	83122	....
		All with Lift Axle 89000 Series	UCE-9399-1	O	....	....	O	....	....	89406
		Model UCA-5431 85000 Series	5352858	O	....	....	O	....	85305	....

# APPLICATION GUIDE

Year	Fitment Notes	OEM#					
			Fleetline	GasSLX	Fleetline	GasSLX	Cab Shock/ Specialty Shock

## FRUEHAUF

## FRUEHAUF

### VARIOUS (cont)

	Model W24T1 Air Ride 85000 Series	UCE-2983-000 UCE-2983-001	....	....	85322	....	....
	Tractor & Trailer Lift Axle with O.E.M. Number 83000 Series	5116-117	....	....	83122	....	....
	Tractor & Trailer Lift Axle with O.E.M. Number 89000 Series	5116-117	....	....	....	89406	....

## FWD CORPORATION

## FWD CORPORATION

	Models with O.E.M. Number 85000 Series	450739	85302	....	....	....	....
	Models with O.E.M. Number 89000 Series	450739	....	89420	....	....	....

## GENERAL TRAILER CO.

## GENERAL TRAILER CO.

	Models with Air Suspension 83000 Series	120-1	....	....	83125	....	....
--	---	-------	------	------	-------	------	------

## GEORGIE BOY MANUFACTURING

## GEORGIE BOY MANUFACTURING

### CLASS A MOTORHOMES

	Models with Workhorse UFO Chassis with Hendrickson Softek Front Suspension 83000 Series	66153-002 F4-BE5-C832-MO	83124	....	....	....	....
	Models with Workhorse UFO Chassis with Hendrickson Softek Front Suspension 89000 Series	66153-002 F4-BE5-C832-MO	....	89407	....	....	....
99-09	All Series MotorHomes with Ford F53 Chassis with 16,000 lb GVW to 22,000 lb GVW 83000 Series	ASH-1229 ASH-1228 9U94-18045-AA ASH-1205 AT-620 ASH-1022 1C34-18045-AA ASH-294 9U9Z-18124-A ASH-25822 ASH-25823 1C34-18045-JA AT-766	83209	....	....	....	....
		ASH-1206 9U94-18080-AA AT-621 ASH-25824 9U9Z-18125-A ASH-1023 ASH-1230 ASH-137	....	....	83122	....	....
		ASH-1229 ASH-1228 9U94-18045-AA ASH-1205 AT-620 ASH-1022 1C34-18045-AA ASH-294 9U9Z-18124-A ASH-25822 ASH-25823 1C34-18045-JA AT-766	....	89414	....	....	....
		ASH-1206 9U94-18080-AA AT-621 ASH-25824 9U9Z-18125-A ASH-1023 ASH-1230 ASH-137	....	....	89406	....	....

## GILLIG

## GILLIG

### VARIOUS

	Additional O.E.M. Interchanges 85000 Series	665568	....	....	85051	....	....
		53-02133-000	....	....	85318	....	....
	Models with Neway ARD-234 Models Truck & Tractor Air Suspension (ARD-234-6) 83000 Series	90044046	....	....	83123	....	....
	Models with Neway ARD-234 Models Truck & Tractor Air Suspension (ARD-234-6) 89000 Series	90044046	....	....	....	89405	....
	Models with O.E.M. Number 83000 Series	82-01878	83122	....	....	....	....

# APPLICATION GUIDE

Year	Fitment Notes	OEM#	 Fleetline   GasSLX		 Fleetline   GasSLX   Cab Shock\ Specialty Shock		

## GILLIG

## GILLIG

### VARIOUS (cont)

	Models with O.E.M. Number 83000 Series	90044683		....	....		83122	....	....	
		90044769 90044770		....	....		 	83207	....	....
		Models with O.E.M. Number 85000 Series	90-1968	 	85712	....		....	....	....
			90-2423 695109 H53-02132-14005 MR6394	 	85723	....		....	....	....
			1583470 H53-20415-006		....	....	 	85051	....	....
			90-1951-SP1		....	....	 	85734	....	....
		Models with O.E.M. Number 89000 Series	82-01878	 	....	89406		....	....	....
			90044683		....	....	 	....	89406	....
			90044769 90044770		....	....	 	....	89407	....
		Phantom Models (30 Foot) with O.E.M. Number 85000 Series	90-2164 SP1	 	85723	....		....	....	....
		Phantom Models with O.E.M. Number 85000 Series	9051024 1145291N000		....	....	 	85916	....	....
		Phantom Models with O.E.M. Number 89000 Series	9051024 1145291N000		....	....	 	....	89430	....
		School Bus w/1" Mounting Pins 85000 Series	53-176 200-171	 	85304	....		....	....	....
		School Bus w/3/4" Mounting Pins 83000 Series	57113	 	83219	....		....	....	....
			57131		....	....	 	83216	....	....
		Transit Bus, Phantom 55, 40, TB40 85000 Series	53-24685	 	85723	....		....	....	....
		90F-1912 53-14010 695110		....	....	 	85318	....	....	

## GLAVAL BUS CO.

## GLAVAL BUS CO.

### CONCORDE II - SERIES

15-23	Models with F-650 chassis with 13,500, 15,500 & 19,000 lb Multi-leaf Rear Springs From 07/15 85000 Series	FC4Z-18125-A ASH-24660 471700011531 FC44-18080-AB		....	....	 	85180	....	....
		Models with F-650 chassis with 19.5" or 22.5" Wheels (22,000 lb GVW) From 07/15 85000 Series	FC4Z-18124-B FC4Z-18124-A ASH-24659 ASH-24658 471700011530 FC44-18045-BB	 	85181	....		....	....
04-15	Models with F-650 chassis with 21,000 lb Rear Air Suspension To 2015 85000 Series	3578858C1 3578858C2 4C4Z-18125-DA		....	....	 	85656	....	....
	Models with F-650 chassis with 22,000 lb Multi-leaf Rear Springs 83000 Series	4C4Z-18125-B 501906C92 ASH-24661		....	....	 	83317	....	....
00-15	Models with F-650 chassis with 10,000 lb Front Suspension 83000 Series	3584116C1 3584116C2 AA-616 4C4Z-18124-QA	 	83175	....		....	....	....
	Models with F-650 chassis with 12,000 & 13,200 lb Front Springs 85000 Series	4C4Z-18124-JB 3584118C2 AA-617 4C4Z-18124-RA AT-812	 	85928	....		....	....	....

## GMC

## GMC

### 3500 & 4000 SERIES

60-62	3500, 4000, B-4000, L-4000, S-4000 with H-130, H-150 and 13800 Axles 83000 Series	.....		....	....	 	83221	....	....
-------	---	-------	--	------	------	------	-------	------	------

### 4500 SERIES

72-80	PS4620 P, 4650P Step Van (Walk-in) 5/8" Upper bolt 83000 Series	22007751			83303	....		....	....
-------	---	----------	--	--	-------	------	--	------	------

# APPLICATION GUIDE

Year	Fitment Notes	OEM#					
				Fleetline	GasSLX		Fleetline

**GMC**

**GMC**

## 5000 SERIES

76-89	C Chassis - Conventional Cab 83000 Series	22012096 22012196		....	....					
75-80	C Chassis - Conventional Cab 83000 Series	4975510	OO	83221	....	....	....	....	....	....
60-62	5000, B-5000, L-5000, S-5000 with 1618 or 16802 Axle 83000 Series	....	OO	....	....	....	....	....	....	....

## 5500 SERIES

60-68	LW-5500 85000 Series	....								
-------	----------------------	------	--	--	--	--	--	--	--	--

## 6000 SERIES

79-80	W Chassis - 72" BBC Steel Tilt Cab 83000 Series	22002293								
		22007751	OO	83126	....	....	....	....	....	....
			OO	83303	....	....	....	....	....	....
	W Chassis - 72" BBC Steel Tilt Cab 89000 Series	22002293	OO	....	89430	....	....	....	....	....
73-75	C, S Chassis - Conventional Cab and School Bus - Exc. with 18500, 20800 & 23000 lb. Rear Axle 83000 Series	22007750 4975494 4975467								
		22007750 4975494 4975467	OO	83207	....	....	....	....	....	....
			OO	....	89407	....	....	....	....	....
63-68	DW - 6000 85000 Series	....								
		....	OO	85005	....	....	....	....	....	....
	DW - 6000 89000 Series	....	OO	....	89430	....	....	....	....	....
60-68	L - 6000 85000 Series	....	OO	85307	....	....	....	....	....	....

## 6500 SERIES

75-89	C, M Chassis - Conventional Cab with 9000 & 12000 lb. Axle 83000 Series	22007751 22002295 22017531 4975511 22017530								
73-80	C, M, S Chassis - Conventional Cab and School Bus - Exc. with 20800 or 23000 lb. Rear Axle 83000 Series	22012169 22012096 3192892								
		4940606 22012166 22012095	OO	....	....	....	....	....	....	....
		4940606 22012166 22012095	OO	....	....	....	89430	....	....	....
		4940606 4975497 22002293 3192890 22012095	OO	83126	....	....	....	....	....	....
		4940606 4975497 22002293 3192890 22012095	OO	....	89430	....	....	....	....	....
75-76	C, M Chassis - Conventional Cab 83000 Series	4975510	OO	83221	....	....	....	....	....	....
73-75	C, M Chassis - Conventional Cab with 9000 & 12000 lb. Axle 83000 Series	4940606 4975497 3192890 22012095								
		4940614 4963854	OO	83216	....	....	....	....	....	....
		4940606 4975497 3192890 22012095	OO	....	89430	....	....	....	....	....
		22007750 4975494 4975467	OO	83207	....	....	....	....	....	....
	C, M, S Chassis - Conventional Cab and School Bus 89000 Series	22007750 4975494 4975467	OO	....	89407	....	....	....	....	....
66-72	CE-6500, CM-6500 Conventional Cab with V-6 Diesel or V-8 Gas Engine 83000 Series	3192892								
		22012096 3192892 3192891	OO	83221	....	....	....	....	....	....

# APPLICATION GUIDE

Year	Fitment Notes	OEM#					
			Fleetline	GasSLX	Fleetline	GasSLX	Cab Shock\ Specialty Shock

**GMC**

**GMC**

## 6500 SERIES (cont)

66-72	CE-6500, ME-6500 Conventional Cab with V-8 Gas Engine with 11000 lb. Axle 83000 Series	4940606 3192890 22012095	O O	83126	....	....	....	....
	CE-6500, ME-6500 Conventional Cab with V-8 Gas Engine with 11000 lb. Axle 89000 Series	4940606 3192890 22012095	O O	....	89430	....	....	....
	CM-6500, TE-6500, TM-6500 Conventional Cab with V-6 Diesel or V-8 Gas Engine 83000 Series	4940606 3192890 22012095	O O	83126	....	....	....	....
		22012096	O O	....	....	83221	....	....
	CM-6500, TE-6500, TM-6500 Conventional Cab with V-6 Diesel or V-8 Gas Engine 89000 Series	4940606 3192890 22012095	O O	....	89430	....	....	....
	EG-6500, DM-6500, ES-6500 Cab/Cowl with V-6 Gas or Diesel or In-line 6 Gas Engines 83000 Series	3171068 3192657 4963853	O O	83216	....	....	....	....
3171462 3192890 22012095		O O	....	....	83126	....	....	
EG-6500, DM-6500, ES-6500 Cab/Cowl with V-6 Gas or Diesel or In-line 6 Gas Engines 89000 Series	3171462 3192890 22012095	O O	....	....	....	89430	....	

## 7000 SERIES

79-89	C, M Chassis - 97" BBC Conventional Cab 83000 Series	22007753 22002295 22017531 22017530	O O	83303	....	....	....
	C, M Chassis - 97" BBC Conventional Cab with 18500, 20800 & 23000 lb. Rear Axle 83000 Series	22012166 22012095	O O	83126	....	....	....
	C, M Chassis - 97" BBC Conventional Cab with 18500, 20800 & 23000 lb. Rear Axle 89000 Series	22012166 22012095	O O	....	89430	....	....
79-81	C, M Chassis - 97" BBC Conventional Cab - Exc. with 18500, 20800 & 23000 lb. Rear Axle 83000 Series	22012169 22012096	O O	83221	....	....	....
79-80	W Chassis - 72" BBC Steel Tilt Cab 83000 Series	22002293	O O	83126	....	....	....
		22007751	O O	83303	....	....	....
	W Chassis - 72" BBC Steel Tilt Cab 89000 Series	22002293	O O	....	89430	....	....

## 7500 SERIES

77-80	H, J Chassis - 92" BBC Conventional Cab 83000 Series	4963854 4984526	O O	83216	....	....	....
73-80	H, J, M Chassis - 92" & 114" BBC Conventional Cab 85000 Series	3171069 22052336 22046483	O O	85304	....	....	....
	H, J, M Chassis - 92" & 114" BBC Conventional Cab with V-6, V-8 Gas or V-6 Diesel Engines 83000 Series	4940614 4963854	O O	83216	....	....	....
	R Chassis - Rear Engine Bus 85000 Series	22012090 5552451	O O	85308	....	....	....
		22012091 5552452	O O	....	....	85303	....
		5552456	O O	....	....	85307	....
	R Chassis - Rear Engine Bus 89000 Series	22012090	O O	....	89422	....	....
		5552451	O O	....	89422	....	....
		22012091	O O	....	....	89422	....
		5552452	O O	....	....	89422	....
	T, W Chassis - 72" BBC Steel Tilt Cab with V-6 Diesel Engine 83000 Series	4940606 4975497 22012095	O O	83126	....	....	....
22007751		O O	83303	....	....	....	
T, W Chassis - 72" BBC Steel Tilt Cab with V-6 Diesel Engine 89000 Series	4940606 4975497 22012095	O O	....	89430	....	....	
T, W Chassis - 72" BBC Steel Tilt Cab with V-6 Gas Engine 85000 Series	22012091 5552452	O O	85303	....	....	....	
T, W Chassis - 72" BBC Steel Tilt Cab with V-6 Gas Engine 89000 Series	22012091 5552452	O O	....	89422	....	....	

# APPLICATION GUIDE

Year	Fitment Notes	OEM#					
			Fleetline	GasSLX	Fleetline	GasSLX	Cab Shock Specialty Shock

**GMC**

**GMC**

## 7500 SERIES (cont)

70-72	72" BBC Tilt Cab with Air Brakes & Gas Engine 85000 Series	22012091 5552452	OO	85303	....				
	72" BBC Tilt Cab with Air Brakes & Gas Engine 89000 Series	22012091 5552452	OO	....	89422				
	72" BBC Tilt Cab with Air Brakes - Exc. Gas Engine 83000 Series	4940606 3171462 22012095	OO	83126	....				
	72" BBC Tilt Cab with Air Brakes - Exc. Gas Engine 89000 Series	4940606 3171462 22012095	OO	....	89430				
66-72	72" BBC Tilt Cab with V-6 2 Cycle Diesel Engine with 17221 Axle 83000 Series	22012096 3192892		....	....	OO	83221	....	....
	72" BBC Tilt Cab with V-6 2 Cycle Diesel Engine with 19101 and 19201 Axle 83000 Series	4940600		....	....	OO	83209	....	....
	72" BBC Tilt Cab with V-6 2 Cycle Diesel Engine with 19101 and 19201 Axle 89000 Series	4940600		....	....	OO	....	89414	....
	92" BBC Conventional Cab with Tapered 2-Leaf Softride 11000 lb. Rating and F120 Axle (12000 lb.) 85000 Series	3171069 22052336 22046483	OO	85304	....				
	92" BBC Conventional Cab with Tapered 2-Leaf Softride 7000 & 9000 lb. Rating and F070, F090, F120 Axle (7000, 9000 & 12000 lb.) 83000 Series	3171068 4940614 3192657 4963854 4963853	OO	83216	....				
66-69	72" BBC Tilt Cab 83000 Series	4940606 3171462 22012095	OO	83126	....				
	72" BBC Tilt Cab 89000 Series	4940606 3171462 22012095	OO	....	89430				

## 8500 SERIES

73-86	H, J, M Chassis - 92" & 114" BBC Conventional Cab 85000 Series	3171069 22052336 22046483	OO	85304	....				
79-82	H, J Chassis - 92" BBC Conventional Cab 4 x 2 with Air Suspension 85000 Series	3171069 22052336 22012065 22046483		....	....	OO	85304	....	....
73-81	H, J Chassis - 92" BBC Conventional Cab with V-6, V-8 Gas Engine 83000 Series	4940614 4963854 4984526	OO	83216	....				
79-80	D, F Chassis - 54" BBC Aluminum Tilt Cab 85000 Series	3171069 22052336 22046483	OO	85304	....				
73-80	R Chassis - Rear Engine Bus 85000 Series	22012090 5552451	OO	85308	....				
		22012091 5552452		....	....	OO	85303	....	....
		5552456		....	....	OO	85307	....	....
	R Chassis - Rear Engine Bus 89000 Series	22012090	OO	....	89422				
		5552451	OO	....	89422				
		22012091		....	....	OO	....	89422	....
		5552452		....	....	OO	....	89422	....
T, W Chassis - 72" BBC Steel Tilt Cab with V-6 Gas Engine 85000 Series	22012091 5552452	OO	85303	....					
	22012091 5552452	OO	....	89422					
66-72	72" BBC Tilt Cab 85000 Series	5544060	OO	85302	....				
	72" BBC Tilt Cab 89000 Series	5544060	OO	....	89420				
	92" BBC Conventional Cab with 7000 & 9000 lb. Axles 85000 Series	3171069 22052336 22046483	OO	85304	....				
67	92" BBC Conventional Cab 83000 Series	3171068 4940614 3192657 4963854 4963853	OO	83216	....				

# APPLICATION GUIDE

Year	Fitment Notes	OEM#					
			Fleetline	GasSLX	Fleetline	GasSLX	Cab Shock\ Specialty Shock

## GMC

## GMC

### 9500 SERIES

77-89	M, N Chassis - 114" BBC Conventional & 108" BBC Aluminum Conventional Cab with Rear GM Air-Ride Suspension (4 req'd) 85000 Series	3171069 22052336 22046483	O O	85304	....	....	....	....	....	....
73-89	D, F Chassis - 54" BBC Aluminum Tilt Cab with Rear GM Air Ride Suspension (4 Req'd) 85000 Series	3171069 22052336 22012065 22046483	O O	85304	....	....	....	....	....	....
	H, J Chassis - 92" BBC Conventional Cab with Rear GM Air-Ride Suspension (4 req'd) 85000 Series	3171069 22052336 22012065 22046483	O O	85304	....	....	....	....	....	....
73-80	T, W Chassis - 72" BBC Steel Tilt Cab 85000 Series	22012091 5552452	O O	85303	....	....	....	....	....	....
	T, W Chassis - 72" BBC Steel Tilt Cab 89000 Series	22012091 5552452	O O	....	89422	....	....	....	....	....
67-72	92" & 114" BBC Conventional Cab 83000 Series	3171068 4940614 3192657 4963854 4963853	O O	83216	....	....	....	....	....	....
66-72	48" BBC Aluminum Tilt Cab 85000 Series	5552454	O O	85302	....	....	....	....	....	....
	48" BBC Aluminum Tilt Cab 89000 Series	5552454	O O	....	89420	....	....	....	....	....
	72" BBC Steel Tilt Cab 85000 Series	22012091 5552452	O O	85303	....	....	....	....	....	....
	72" BBC Steel Tilt Cab 89000 Series	22012091 5552452	O O	....	89422	....	....	....	....	....

### ADDITIONAL APPLICATIONS

1500 Models	Models with Rear Suspension 83000 Series	35901-0005		....	....	O O	83219	....	....	....
-------------	--	------------	--	------	------	--------	-------	------	------	------

### B7

93-02	Models with O.E.M. Number	88982682 15588554 22064230 15123676		83136	....	....	....	....	....	....
	School Bus Chassis w/15000, 19000, 21000 lb Multileaf Springs	15174902 22064232		....	....		85071	....	....	....

### C - SERIES (C4500, C5500) TOPKICK

90-99	C Chassis - Conventional Cab with 9100 to 17500 lb Rear Axle 83000 Series	22064432		....	....	O O	83221	....	....	....
83-89	C Chassis - Conventional Cab with 9100 to 17500 lb. Rear Axle 83000 Series	22064432		....	....	O O	83221	....	....	....

### C - SERIES (C6500, C7500, C8500) TOPKICK

90-09	Conventional Cab Front Shock with O.E.M. Number 83000 Series	88982682 15588554 15887728 15174898 19152843 22064230 15123676		83136	....	....	....	....	....	....
	Conventional Cab w/19000, 21000, 23000 lb Taperleaf Springs (EXC Low Profile Vehicle) 83000 Series	22064233		....	....		83136	....	....	....
	Conventional Cab With 15000, 19000, 21000 lb Multileaf Springs 85000 Series	15174902 88982686 22064232		....	....		85071	....	....	....
95-02	Models with Hendrickson Air Suspension (Stamping number 47902-13) 83000 Series	12474915 15963161		....	....	O O	83122	....	....	....
	Models with Hendrickson Air Suspension (Stamping number 47902-13) 89000 Series	12474915 15963161		....	....	O O	....	89406	....	....
90-99	Conventional Cab with 9100 to 17500 lb Rear Axle 83000 Series	22064432		....	....	O O	83221	....	....	....
83-89	Conventional Cab with 9100 to 17500 lb. Rear Axle 83000 Series	22064432		....	....	O O	83221	....	....	....

### C4500 TOPKICK

90-02	C Chassis - Conventional Cab with 15000, 19000, 21000 lb Multileaf Springs 85000 Series	15174902 88982686 22064232		....	....		85071	....	....	....
	C Chassis - Conventional Cab with 19000, 21000, 23000 lb Taperleaf Springs (EXC Low Profile Vehicle) 83000 Series	22064233		....	....		83136	....	....	....



# APPLICATION GUIDE

Year	Fitment Notes	OEM#					
			Fleetline	GasSLX	Fleetline	GasSLX	Cab Shock Specialty Shock

**GMC**

**GMC**

## C4500 TOPKICK (cont)

90-02	C Chassis - Conventional Cab with Front Shock with O.E.M. Number 83000 Series	88982682 15588554 15887728 19152843 22064230 15123676	83136							
-------	---	--	-------	--	--	--	--	--	--	--

## C5500 TOPKICK

90-02	C Chassis - Conventional Cab with 15000, 19000, 21000 lb Multileaf Springs 85000 Series	15174902 88982686 22064232								
	C Chassis - Conventional Cab with 19000, 21000, 23000 lb Taperleaf Springs (EXC Low Profile Vehicle) 83000 Series	22064233					85071			
	C Chassis - Conventional Cab with Front Shock with O.E.M. Number 83000 Series	88982682 15588554 15887728 19152843 22064230 15123676	83136							

## C6000 TOPKICK

90-96	Truck Cabs with Link Cabmate Model GMC104TK	1201-0054 1202-0054								
-------	---	------------------------	--	--	--	--	--	--	--	--

## C6500 TOPKICK

03-09	Truck Cabs with Link Cabmate Model GMC104TK	1201-0054 1202-0054								
97-99	Truck Cabs with Link Cabmate Model GMC104TK	1201-0054 1202-0054								

## C7000 TOPKICK

90-96	Truck Cabs with Link Cabmate Model GMC104TK	1201-0054 1202-0054								
-------	---	------------------------	--	--	--	--	--	--	--	--

## C7500 TOPKICK

97-09	Truck Cabs with Link Cabmate Model GMC104TK	1201-0054 1202-0054								
-------	---	------------------------	--	--	--	--	--	--	--	--

## C8500 TOPKICK

03-09	Truck Cabs with Link Cabmate Model GMC104TK	1201-0054 1202-0054								
-------	---	------------------------	--	--	--	--	--	--	--	--

## COACHES

	4100, 4900 Models 85000 Series	3192416 4975552 3182842 3188599	85711							
	4500, 5300 Models 85000 Series	3166657 3192333	85700							
	Models with O.E.M. Number 85000 Series	3178507 5316794 5527271 3178106 5549924 3189265 3178995 5304059 5352857 5316784 5527272	85700							

## T5500

97-09	FL1 Tilt Cab with 8100 lb Axle 83000 Series	22165188 22165187 22064804 22064805	83136							
	FL2 Tilt Cab with 5000 to 11000 lb Axle 83000 Series	22166442 22064807	83136							
	FL3 Tilt Cab with 14575 lb Axle 83000 Series	22165189 22064806	83136							
90-06	Tilt Cab with 15000, 19000, 21000 lb Multileaf Springs 85000 Series	15174902 22064232								
92-99	Tilt Cab with 19000, 21000, 23000 lb Taperleaf Springs (EXC Low Profile Veh.) 83000 Series	22064233								
99	Models with Hendrickson Air Suspension (Stamping number 47902-13) 83000 Series	12474915 15963161								



# APPLICATION GUIDE

Year	Fitment Notes	OEM#					
			Fleetline	GasSLX	Fleetline	GasSLX	Cab Shock\ Specialty Shock

**GMC**

**GMC**

## T5500 (cont)

99	Models with Hendrickson Air Suspension (Stamping number 47902-13) 89000 Series	12474915 15963161	....	....	O	O	89406	....
----	--	----------------------	------	------	---	---	-------	------

## T6500

03	FL1 Tilt Cab with 8100 lb Axle 83000 Series	22165188 22165187 22064804 22064805		83136	....		....	....
	FL2 Tilt Cab with 5000 to 11000 lb Axle 83000 Series	22166442 22064807		83136	....		....	....
	FL3 Tilt Cab with 14575 lb Axle 83000 Series	22165189 22064806		83136	....		....	....
	Tilt Cab with 15000, 19000, 21000 lb Multileaf Springs 85000 Series	15174902 22064232		....	....		85071	....
92-96	Tilt Cab with 19000, 21000, 23000 lb Taperleaf Springs (EXC Low Profile Veh.) 83000 Series	22064233		....	....		83136	....
90-96	Tilt Cab with 15000, 19000, 21000 lb Multileaf Springs 85000 Series	15174902 22064232		....	....		85071	....

## T7500

04-09	FL1 Tilt Cab with 8100 lb Axle	22165188 22165187 22064804 22064805		83136	....		....	....
	FL2 Tilt Cab with 5000 to 11000 lb Axle	22166442 22064807		83136	....		....	....
	FL3 Tilt Cab with 14575 lb Axle	22165189 22064806		83136	....		....	....
04-06	Tilt Cab with 15000, 19000, 21000 lb Multileaf Springs	15174902 22064232		....	....		85071	....
03	FL1 Tilt Cab with 8100 lb Axle 83000 Series	22165188 22165187 22064804 22064805		83136	....		....	....
	FL2 Tilt Cab with 5000 to 11000 lb Axle 83000 Series	22166442 22064807		83136	....		....	....
	FL3 Tilt Cab with 14575 lb Axle 83000 Series	22165189 22064806		83136	....		....	....
	Tilt Cab with 15000, 19000, 21000 lb Multileaf Springs 85000 Series	15174902 22064232		....	....		85071	....
97-02	FL1 Tilt Cab with 8100 lb Axle	22165188 22165187 22064804 22064805		83136	....		....	....
	FL2 Tilt Cab with 5000 to 11000 lb Axle	22166442 22064807		83136	....		....	....
	FL3 Tilt Cab with 14575 lb Axle	22165189 22064806		83136	....		....	....
	Tilt Cab with 15000, 19000, 21000 lb Multileaf Springs	15174902 22064232		....	....		85071	....
97-99	Tilt Cab with 19000, 21000, 23000 lb Taperleaf Springs (EXC Low Profile Veh.)	22064233		....	....		83136	....
99	Models with Hendrickson Air Suspension (Stamping number 47902-13)	12474915 15963161		....	....		83122	89406
92-96	Tilt Cab with 19000, 21000, 23000 lb Taperleaf Springs (EXC Low Profile Veh.) 83000 Series	22064233		....	....		83136	....
90-96	Tilt Cab with 15000, 19000, 21000 lb Multileaf Springs 85000 Series	15174902 22064232		....	....		85071	....

## T8500

97-09	FL1 Tilt Cab with 8100 lb Axle 83000 Series	22165188 22165187 22064804 22064805		83136	....		....	....
	FL2 Tilt Cab with 5000 to 11000 lb Axle 83000 Series	22166442 22064807		83136	....		....	....
	FL3 Tilt Cab with 14575 lb Axle 83000 Series	22165189 22064806		83136	....		....	....
98-06	Tilt Cab with 15000, 19000, 21000 lb Multileaf Springs 85000 Series	15174902 22064232		....	....		85071	....
92-99	Tilt Cab with 19000, 21000, 23000 lb Taperleaf Springs (EXC Low Profile Veh.) 83000 Series	22064233		....	....		83136	....
99	Models with Hendrickson Air Suspension (Stamping number 47902-13) 83000 Series	12474915 15963161		....	....		83122	....

# APPLICATION GUIDE

Year	Fitment Notes	OEM#					
			Fleetline	GasSLX	Fleetline	GasSLX	Cab Shock/ Specialty Shock

## GMC

## GMC

### T8500 (cont)

99	Models with Hendrickson Air Suspension (Stamping number 47902-13) 89000 Series	12474915 15963161	....	....	☉	....	89406	....
----	--	----------------------	------	------	---	------	-------	------

### VARIOUS

	Astro Cabover (Sleeper & Non-Sleeper Trucks) with Link Cabmate Model GMC-2P-A 83000 Series	1202-0032	....	....	☉	....	....	83016
	Brigadier Tractors with J9 Cabs with Link Cabmate Model GMC92J9 83000 Series	1202-0012	....	....	☉	....	....	83023
	TopKick Truck Cabs with Link Cabmate Model GMC92TK 83000 Series	1202-0012	....	....	☉	....	....	83023
79-09	Conventional Trucks measuring 108" BBC or 116" BBC with Link Cabmate Model GMC816 83000 Series	1202-0012	....	....	☉	....	....	83023

### WH SERIES

	WHS, WHR, WHL or WHE Models with Front Dual Shocks 83000 Series	3082284		83400	....	☉	....	....
--	---	---------	--	-------	------	---	------	------

## GRANNING SUSPENSION

## GRANNING SUSPENSION

### MODEL L120 SELF STEER AXLE

	Models with O.E.M. Number Specialty Shock	701071-01	☉	☉	....	646155	....
--	---	-----------	---	---	------	--------	------

### VARIOUS

	Models T950-1200, -1400, -1700 85000 Series	2697	....	....	☉	85712	....	....
	Models with O.E.M. Number 83000 Series	OE12425 1085	....	....	☉	83214	....	....

## GREAT DANE TRAILER

## GREAT DANE TRAILER



	Trailers with Great Dane part number 83000 Series	HENS-20001	....	....	☉	83389	....	....
	Trailers with Great Dane part number 85000 Series	HENS-20002 HENS-23566	....	....	☉	85000	....	....
		REY18165-01	....	....	☉	85006	....	....
		HENS21292 HENS-21292	....	....	☉	85052	....	....
		HENS-23649	....	....	☉	85064	....	....
		HENS-20126	....	....	☉	85323	....	....
		MER202447	....	....	☉	85919	....	....
		Trailers with Great Dane part number 89000 Series	HENS-20002 HENS-20001 HENS-23566 HENS-20126	....	....	☉	....	89436
	Trailers with Great Dane part number Heavy Duty 85000 Series	HENS-24088	....	....	☉	85000	....	....
	Trailers with Great Dane part number Heavy Duty 89000 Series	HENS-24088	....	....	☉	....	89436	....
	Trailers with Great Dane part number Standard 83000 Series	HENS-24088	....	....	☉	83389	....	....
	Trailers with Great Dane part number Standard 89000 Series	HENS-24088	....	....	☉	....	89436	....
	Trailers with Reyco 86 AR / RS 1015, 1035, 3015, 3035 Slider Air Suspension 85000 Series	18165-01	....	....	☉	85006	....	....
	Trailers with Reyco Suspension 87 83000 Series	18163-01	....	....	☉	83207	....	....
	Trailers with Reyco Suspension 87 89000 Series	18163-01	....	....	☉	....	89407	....
	Trailers with Reyco Suspension 88 83000 Series	18164-01	....	....	☉	83122	....	....
	Trailers with Reyco Suspension 88 89000 Series	18164-01	....	....	☉	....	89406	....

## GREYHOUND BUS

## GREYHOUND BUS

	City Cruiser 85000 Series	12TA-01-013	☉	85303	....	....	....	....
	City Cruiser 89000 Series	12TA-01-013	☉	....	89422	....	....	....
	MC5, MC7, MC8 85000 Series	3178157	☉	85700	....	....	....	....

# APPLICATION GUIDE

Year	Fitment Notes	OEM#					
			Fleetline	GasSLX	Fleetline	GasSLX	Cab Shock\ Specialty Shock

## GRUMMAN BUS

## GRUMMAN BUS

### VARIOUS (cont)

	Model 870 Flex Bus 85000 Series	22025305 22025067 97-2210-00002 97-2210-00001 97-2210-00004 97-2210-00003 97-2210-00005		85900	....		85704	....	
--	---------------------------------	---	--	-------	------	--	-------	------	--

## GULF STREAM

## GULF STREAM

### ATRIUM

03-06	Models with Freightliner XC Chassis with ZF - IFS Front Suspension and 23,000 lb GVW or Greater 85000 Series	16-18103-000 481700000493		85900	....		....	....	
	MotorHomes with Freightliner XC Chassis & AS120 Front Suspension AS120 Front Suspension 83000 Series	16-16874-000 16-16737-000 141700131810		83160	....		....	....	....
	MotorHomes with Freightliner XC Chassis and ADL200 Suspension w/ 20K Rear 85000 Series	16-16873-000 141700131809 16-16736-000		....	....		85029	....	....

### ENDURA

04-07	MotorHomes with Chevy Kodiak Chassis 83000 Series	88982682 15588554 15887728 19152843 22064230 15123676		83136	....		....	....	
-------	---	--	--	-------	------	--	------	------	--

### FRIENDSHIP

02-06	Models with Freightliner XC Chassis with ZF - IFS Front Suspension and 23,000 lb GVW or Greater 85000 Series	16-18103-000 481700000493		85900	....		....	....	
	MotorHomes with Freightliner XC Chassis & AS120 Front Suspension AS120 Front Suspension 83000 Series	16-16874-000 16-16737-000 141700131810		83160	....		....	....	....
	MotorHomes with Freightliner XC Chassis and ADL200 Suspension w/ 20K Rear 85000 Series	16-16873-000 141700131809 16-16736-000		....	....		85029	....	....

### SCENIC CRUISER

02-06	Models with Freightliner XC Chassis with ZF - IFS Front Suspension and 23,000 lb GVW or Greater 85000 Series	16-18103-000 481700000493		85900	....		....	....	
	MotorHomes with Freightliner XC Chassis & AS120 Front Suspension AS120 Front Suspension 83000 Series	16-16874-000 16-16737-000 141700131810		83160	....		....	....	....
	MotorHomes with Freightliner XC Chassis and ADL200 Suspension w/ 20K Rear 85000 Series	16-16873-000 141700131809 16-16736-000		....	....		85029	....	....

## HARDEE MFG.

## HARDEE MFG.

### VARIOUS

	Models with O.E.M. Number 83000 Series	8030223		....	....		83207	....	
	Models with O.E.M. Number 85000 Series	AS789B		....	....		85014	....	....
	Models with O.E.M. Number 89000 Series	8030223		....	....		....	89407	....

## HAUSMAN

## HAUSMAN

	Models with O.E.M. Number 85000 Series	695110		....	....		85318	....	
		695119		....	....		85702	....	....



## HENDRICKSON TRAILER SUSPENSION SYSTEMS

## HENDRICKSON TRAILER SUSPENSION SYSTEMS

### ADDITIONAL APPLICATIONS

	AB-32-001 Models 85000 Series	A-1667		....	....		85000	....	
	AB-32-001 Models 89000 Series	A-1667		....	....		....	89436	....
	HK HK200M (Standard with 11" - 12" Ride Height) 85000 Series	S-4084 A-4084		....	....		85005	....	....
	HK HK200M (Standard with 11" - 12" Ride Height) 89000 Series	S-4084 A-4084		....	....		....	89430	....

# APPLICATION GUIDE

Year	Fitment Notes	OEM#					
			Fleetline	GasSLX	Fleetline	GasSLX	Cab Shock/ Specialty Shock

## HENDRICKSON TRAILER SUSPENSION SYSTEMS

## HENDRICKSON TRAILER SUSPENSION SYSTEMS

### ADDITIONAL APPLICATIONS (cont)

HK HK200M Models (Standard with 9.25" Ride Height) 85000 Series	S-2218 A-2218	....	....	85030	....	....
HK HK200M Models (Standard with 9.25" Ride Height) 89000 Series	S-2218 A-2218	....	....	....	89440	....
HK HTHKR (All) 85000 Series	S-23650 S-21292 A-21292 B-23650	....	....	85052	....	....
HK190T (Slider Air Suspension) 85000 Series	A-21292	....	....	85052	....	....
HK230 (Slider Air Suspension) 85000 Series	A-21292	....	....	85052	....	....
HS190T (Slider Air Suspension) 83000 Series	A-20001	....	....	83389	....	....
HS190T (Slider Air Suspension) 89000 Series	A-20001	....	....	....	89436	....
HS230 (Slider Air Suspension) 85000 Series	A-20002	....	....	85000	....	....
HS230 (Slider Air Suspension) 89000 Series	A-20002	....	....	....	89436	....
MT-45,MTL45,MTL-50 85000 Series	S-1667	....	....	85000	....	....
MT-45,MTL45,MTL-50 89000 Series	S-1667	....	....	....	89436	....
TDC-014 85000 Series	A-2212	....	....	85029	....	....

### CONNEX

CXU 23K / 25K (Standard with 5.5" - 6.5" Ride Height) 85000 Series	S-23650 B-23650	....	....	85052	....	....
CXY 23K / 25K (Standard with 6.5" - 9" Ride Height) 85000 Series	S-23651 B-23651	....	....	85045	....	....
ST CXSL 25K (Standard with 14" - 19" Ride Height) 85000 Series	A-2212 S-2212	....	....	85029	....	....

### HLP PARALIFT

Auxiliary Lifiable Steerable System (HL) Specialty Shock	A-14496			646155		
--	---------	---	--	--------	--	--

### HLU PARALIFT ULTRA

Auxiliary Lifiable Steerable System (HL) Specialty Shock	A-14496			646155		
--	---------	---	--	--------	--	--

### INTRAAX

AA230T & AA250T Models with O.E.M. Number 85000 Series	A-20002	....	....	85000	....	....
	A-20889 A-20126	....	....	85323	....	....
	B-22345	....	....	85911	....	....
AA230T & AA250T Models with O.E.M. Number 89000 Series	A-20889 A-20126 A-20002	....	....	....	89436	....
AAEDL 30K (Extended Service with 14" - 15" Ride Height & High Damping - Rear Mounting) 85000 Series	S-25436 B-25436	....	....	85916	....	....
AAEDL 30K (Extended Service with 14" - 15" Ride Height & High Damping - Rear Mounting) 89000 Series	S-25436 B-25436	....	....	....	89430	....
AAEDL Models For Models with 12" Ride Height 85000 Series	B-24023	....	....	85738	....	....
AAEDL Models For Models with 14" to 19" Ride Height 85000 Series	B-23316	....	....	85382	....	....
AAEDL Models For Models with 9" Ride Height 85000 Series	B-24579	....	....	85939	....	....
AAEDT 30K (Extended Service with 14" Ride Height & High Damping - Front Mounting) 85000 Series	B-23316 S-23316	....	....	85382	....	....
AAEDT 30K Models ( w/14" and 15" Ride Height- High Damping) 85000 Series	B-25436	....	....	85916	....	....
AAEDT 30K Models ( w/14" and 15" Ride Height- High Damping) 89000 Series	B-25436	....	....	....	89430	....
AAEDT 30K Models ( w/14" Ride Height) 85000 Series	B-23361	....	....	85911	....	....
AAEDT 30K Models ( w/15", 16" & 17" Ride Height) 85000 Series	B-25515	....	....	85338	....	....
AAL 23K / 25K / 30K (Extended service with 12" Ride Height & High Damping) 85000 Series	B-24023 S-24023	....	....	85738	....	....

# APPLICATION GUIDE

Year	Fitment Notes	OEM#					
			Fleetline	GasSLX	Fleetline	GasSLX	Cab Shock\ Specialty Shock





## HENDRICKSON TRAILER SUSPENSION SYSTEMS

## HENDRICKSON TRAILER SUSPENSION SYSTEMS

### INTRAAX (cont)

AAL 23K / 25K / 30K (Extended Service with 14" to 19" Ride Height & High Damping - Front Mounting) 85000 Series	B-23316 S-23316	....	....	○	85382	....	....
AAL 23K / 25K / 30K (Extended Service with 6.5" - 9" Ride Height - High Damping) 85000 Series	S-24579 B-24579	....	....	○	85939	....	....
AAL 23K, 25K & 30K Models Front shocks with 12" Ride Height 85000 Series	B-23566	....	....	○	85000	....	....
AAL 23K, 25K & 30K Models Front shocks with 12" Ride Height 89000 Series	B-23566	....	....	○	....	89436	....
AAL 23K, 25K & 30K Models Front shocks with 14" to 19" Ride Height 85000 Series	A-2212	....	....	○	85029	....	....
AAL 23K, 25K & 30K Models Front shocks with 6.5" to 9" Ride Height 85000 Series	B-23651	....	....	○	85045	....	....
AAL 23K, 25K & 30K Models Rear shocks with 14" to 17" Ride Height 85000 Series	B-25437	....	....	○	85337	....	....
AAL 23K, 25K & 30K Models Rear shocks with 6.5" to 7.5" Ride Height 85000 Series	B-20345	....	....	○	85345	....	....
AAL 23K, 25K & 30K Models Rear shocks with 9" to 12" Ride Height 85000 Series	B-25436	....	....	○	85916	....	....
AAL 23K, 25K & 30K Models Rear shocks with 9" to 12" Ride Height 89000 Series	B-25436	....	....	○	....	89430	....
AANL 23K (Extended Service with 13" - 17" Ride Height & High Damping - Rear Mounting) 85000 Series	S-25437 B-25437	....	....	○	85337	....	....
AANL 23K (Extended Service with 8" - 12" Ride Height & High Damping - Rear Mounting) 85000 Series	S-25436 B-25436	....	....	○	85916	....	....
AANL 23K (Extended Service with 8" - 12" Ride Height & High Damping - Rear Mounting) 89000 Series	S-25436 B-25436	....	....	○	....	89430	....
AANL 23K Models with 12" to 17" Ride Height - High Damping 85000 Series	B-25515	....	....	○	85338	....	....
AANL 23K Models with 6.5" to 9" Ride Height - High Damping 85000 Series	B-24579	....	....	○	85939	....	....
AANL 23K Models with 6.5" to 9" Ride Height - Standard 85000 Series	B-23651	....	....	○	85045	....	....
AANLS - 20K with Rear shocks with 9" Ride Height 85000 Series	B-23316	....	....	○	85382	....	....
AANLS 20K (Extended Service with 12" Ride Height & High Damping (Rear Mounting)) 85000 Series	B-20345 S-20345	....	....	○	85345	....	....
AANLS 20K (Extended service with 12" Ride Height & High Damping - Front Mounting) 85000 Series	B-24023 S-24023	....	....	○	85738	....	....
AANLS 20K (Extended Service with 6.5" - 7" Ride Height & High Damping) 85000 Series	S-25515 B-25515	....	....	○	85338	....	....
AANLS 20K (Extended Service with 6.5" - 9" Ride Height & High Damping - Front Mounting) 85000 Series	S-24579 B-24579	....	....	○	85939	....	....
AANLS 20K (Standard with 6.5" - 9" Ride Height - Front Mounting) 85000 Series	S-23651 B-23651	....	....	○	85045	....	....
AANLS 20K - Standard with 12" Ride Height (Front Mounting) 85000 Series	B-23566	....	....	○	85000	....	....
AANLS 20K - Standard with 12" Ride Height (Front Mounting) 89000 Series	B-23566	....	....	○	....	89436	....
AANT 23K (Standard with 13" Ride Height and High Damping) 85000 Series	S-23651 B-23651	....	....	○	85045	....	....
AANT 23K (Standard with 13.5" - 17" Ride Height & High Damping) 85000 Series	S-23361 B-23361	....	....	○	85911	....	....
AANT 23K Models (High Damping) 85000 Series	B-24023	....	....	○	85738	....	....
AANT 23K Models (Hvy Duty) 85000 Series	B-24125	....	....	○	85323	....	....
AANT 23K Models (Hvy Duty) 89000 Series	B-24125	....	....	○	....	89436	....
AANT 23K Models (Limited Rebound) 85000 Series	B-23361	....	....	○	85911	....	....
AANT 23K Models (Standard) 85000 Series	B-23566	....	....	○	85000	....	....
AANT 23K Models (Standard) 89000 Series	B-23566	....	....	○	....	89436	....
AANT 23K Models Extended Service with 13" Ride Height - High Damping 85000 Series	S-24579 B-24579	....	....	○	85939	....	....
AAT 23K Models (High Damping) 85000 Series	B-24023	....	....	○	85738	....	....
AAT 23K Models (Hvy Duty) 85000 Series	B-24125	....	....	○	85323	....	....
AAT 23K Models (Hvy Duty) 89000 Series	B-24125	....	....	○	....	89436	....

















# APPLICATION GUIDE

Year	Fitment Notes	OEM#					
			 Fleetline	GasSLX	 Fleetline	GasSLX	Cab Shock Specialty Shock









## HENDRICKSON TRAILER SUSPENSION SYSTEMS

## HENDRICKSON TRAILER SUSPENSION SYSTEMS

### INTRAAX (cont)

AAT 23K Models (Limited Rebound) 85000 Series	B-23361	....	....	 85911	....	....
AAT 23K Models (Standard) 85000 Series	B-23566	....	....	 85000	....	....
AAT 23K Models (Standard) 89000 Series	B-23566	....	....	 ....	89436	....
AAT 25K Models (High Damping) 85000 Series	B-24023	....	....	 85738	....	....
AAT 25K Models (Hvy Duty) 85000 Series	B-24125	....	....	 85323	....	....
AAT 25K Models (Hvy Duty) 89000 Series	B-24125	....	....	 ....	89436	....
AAT 25K Models (Limited Rebound) 85000 Series	B-23361	....	....	 85911	....	....
AAT 25K Models (Standard) 85000 Series	B-23566	....	....	 85000	....	....
AAT 25K Models (Standard) 89000 Series	B-23566	....	....	 ....	89436	....
AAT 30K (Limited Rebound) 85000 Series	S-23361 B-23361	....	....	 85911	....	....
AAT 30K (Standard) 85000 Series	B-23566	....	....	 85000	....	....
AAT 30K (Standard) 89000 Series	B-23566	....	....	 ....	89436	....
AAT 30K Models 85000 Series	B-24023	....	....	 85738	....	....
AAZL 23K / 46K Models with 12" Ride Height - High Damping 85000 Series	B-24023	....	....	 85738	....	....
AAZL 23K / 46K Models with 12" Ride Height - Standard 85000 Series	B-23566	....	....	 85000	....	....
AAZL 23K / 46K Models with 12" Ride Height - Standard 89000 Series	B-23566	....	....	 ....	89436	....
AAZL 23K / 46K Models with 6.5" to 9" Ride Height - High Damping 85000 Series	B-24579	....	....	 85939	....	....
AAZL 23K / 46K Models with 6.5" to 9" Ride Height - Standard 85000 Series	B-23651	....	....	 85045	....	....
AAZNT 23K / 46K / 69K Models with 12" to 17" Ride Height - High Damping 85000 Series	B-24023	....	....	 85738	....	....
AAZNT 23K / 46K / 69K Models with 12" to 17" Ride Height - Standard 85000 Series	B-23566	....	....	 85000	....	....
AAZNT 23K / 46K / 69K Models with 12" to 17" Ride Height - Standard 89000 Series	B-23566	....	....	 ....	89436	....
HKANL 23K (Standard) 85000 Series	S-25515 B-25515	....	....	 85338	....	....
Low Ride Height Models with (10.5" to 15" Ride Height) 85000 Series	B-23013	....	....	 85000	....	....
Low Ride Height Models with (10.5" to 15" Ride Height) 89000 Series	B-23013	....	....	 ....	89436	....
Low Ride Height Models with (15.5" to 21" Ride Height - High Damping) 85000 Series	B-23316	....	....	 85382	....	....
Low Ride Height Models with (15.5" to 21" Ride Height - Std Damping) 85000 Series	B-23315	....	....	 85029	....	....
Low Ride Height Models with (6.5" to 8" Ride Height - High Damping) 85000 Series	B-22312	....	....	 85939	....	....
Low Ride Height Models with (6.5" to 8" Ride Height) 85000 Series	B-22311	....	....	 85045	....	....

### TOP MOUNT STYLE

HT190T (All Models) 83000 Series	A-20001	....	....	 83389	....	....
HT190T (All Models) 89000 Series	A-20001	....	....	 ....	89436	....
HT230T ( TA14-020) 85000 Series	B-22345 S-23361 B-23361	....	....	 85911	....	....
HT230T ( TA15-521, TA17-521) 85000 Series	B-21553	....	....	 85738	....	....
HT230T ( TA15-522, TA17-522) 87000 Series	B-21699	....	....	 87018	....	....
HT230T (-14-020, -14-021, TA14-021) 85000 Series	A-2212	....	....	 85029	....	....
HT230T (-14-17, -15-17, -15-517, -17-517, TA15-517, TA15-520, TA17-517) 85000 Series	A-20126	....	....	 85323	....	....
HT230T (-14-17, -15-17, -15-517, -17-517, TA15-517, TA15-520, TA17-517) 89000 Series	A-20126	....	....	 ....	89436	....



# APPLICATION GUIDE

Year	Fitment Notes	OEM#	 Fleetline    GasSLX		 Fleetline    GasSLX    Cab Shock\ Specialty Shock		
------	---------------	------	-------------------------	--	---	--	--

## HENDRICKSON TRAILER SUSPENSION SYSTEMS

## HENDRICKSON TRAILER SUSPENSION SYSTEMS

### TOP MOUNT STYLE (cont)

HT230T (-14-7,-14-11, -15-7,-15-11,-15-12,-15-28,TA14-7,TA15-7,TA16-7,TA17-7,TB14-33,TB15-28) 85000 Series	A-2160	....	....	85014	....	....
HT230T All except Models listed below 85000 Series	A-20002	....	....	85000	....	....
HT230T All except Models listed below 89000 Series	A-20002	....	....	....	89436	....
HT250T (All Models) 85000 Series	A-2212	....	....	85029	....	....
HT300T & N-HT300T ( -15-007, -15-011, -15-021,-17-007,-17-011, -17-012, TB19-007,TB19-020) 85000 Series	A-2160	....	....	85014	....	....
HT300T & N-HT300T ( -15-017, -15-518, -17-518,-17-520) 85000 Series	B-21553	....	....	85738	....	....
HT300T & N-HT300T ( TB15-027 ) 85000 Series	B-24579	....	....	85939	....	....
HT300T & N-HT300T ( TB15-518 ) 87000 Series	B-21699	....	....	87018	....	....
HT300T & N-HT300T (All except Models listed below) 85000 Series	A-20126	....	....	85323	....	....
HT300T & N-HT300T (All except Models listed below) 89000 Series	A-20126	....	....	....	89436	....
T-15-140, -155, -172, 244, -376 85000 Series	A-2218	....	....	85030	....	....
T-15-140, -155, -172, 244, -376 89000 Series	A-2218	....	....	....	89440	....
T-15-324 85000 Series	A-2160	....	....	85014	....	....
T-17-141, -174, -284 85000 Series	A-2218	....	....	85030	....	....
T-17-141, -174, -284 89000 Series	A-2218	....	....	....	89440	....
TMB-14-120 85000 Series	A-2213	....	....	85010	....	....
TMB-17-135 85000 Series	A-4084	....	....	85005	....	....
TMB-17-135 89000 Series	A-4084	....	....	....	89430	....

### UNDERSLUNG STYLE

HT190U ( -6.75-001 / -6.75-002 / -6.75-003 / -6.75-020 ) 85000 Series	A-2212	....	....	85029	....	....
HT190U ( U-7.5-517 ) 85000 Series	A-20002	....	....	85000	....	....
HT190U ( U-7.5-517 ) 89000 Series	A-20002	....	....	....	89436	....
HT190U ( U-9-022 / UB7-021 ) 85000 Series	B-23649	....	....	85064	....	....
HT190U (All except Models listed above) 83000 Series	A-20001	....	....	83389	....	....
HT190U (All except Models listed above) 89000 Series	A-20001	....	....	....	89436	....
HT250U & N-HT250U (All except Models listed below) 85000 Series	A-20002	....	....	85000	....	....
HT250U & N-HT250U (All except Models listed below) 89000 Series	A-20002	....	....	....	89436	....
HT250U & N-HT250U (U-6.5-030, U-6.5-031) 85000 Series	A-2160	....	....	85014	....	....
HT250U & N-HT250U (U-6.5-27,U-9-27 & -28,U-14-28,UB6.5-522,UB7.5-27 & -522,UB9-522,UB12-27 & -28,UB14-27 & -28) 85000 Series	B-21553	....	....	85738	....	....
HT250U & N-HT250U (U-6.5-517, U-7.5-17, U-7.5-517, U-9-517, U-12-517, U-14-514, UB6.5-517, UB7.5-517) 85000 Series	A-20126	....	....	85323	....	....
HT250U & N-HT250U (U-6.5-517, U-7.5-17, U-7.5-517, U-9-517, U-12-517, U-14-514, UB6.5-517, UB7.5-517) 89000 Series	A-20126	....	....	....	89436	....
HT250U & N-HT250U (U-7.5-021, U-7.5-022) 85000 Series	A-1667	....	....	85000	....	....
HT250U & N-HT250U (U-7.5-021, U-7.5-022) 89000 Series	A-1667	....	....	....	89436	....
HT250U & N-HT250U (U-9-20 & -21 & -23, U-9.5-26, U-15-22, UB9-22, UB15-22) 85000 Series	A-2212	....	....	85029	....	....
HT250U-Y (All Models) 85000 Series	A-20002	....	....	85000	....	....
HT250U-Y (All Models) 89000 Series	A-20002	....	....	....	89436	....
HT250US (Models with Angled and Frame Clearance Mount) (Standard Travel w/ 6.5", 7.5" & 14" Ride Height -High Damping) 85000 Series	B-24579	....	....	85939	....	....

# APPLICATION GUIDE

Year	Fitment Notes	OEM#					
			Fleetline	GasSLX	Fleetline	GasSLX	Cab Shock/ Specialty Shock

## HENDRICKSON TRAILER SUSPENSION SYSTEMS

## HENDRICKSON TRAILER SUSPENSION SYSTEMS

### UNDERSLUNG STYLE (cont)



HT250US (Models with Angled and Frame Clearance Mount) (Standard Travel w/ 6.5", 7.5" & 14" Ride Height) 85000 Series	B-23651	....	....	....	....	85045	....	....
HT250US (Models with O.E.M. Number) 85000 Series	B-22862	....	....	....	....	85045	....	....
	B-21947	....	....	....	....	85052	....	....
	B-21936	....	....	....	....	85064	....	....
	B-23316	....	....	....	....	85382	....	....
HT250US (Models with Remote Shock Mount) (Extended Rebound w/ 6.5" to 9" Ride Height -High Damping) 85000 Series	B-23316	....	....	....	....	85382	....	....
HT250US (Models with Remote Shock Mount) (Extended Rebound w/ 6.5" to 9" Ride Height) 85000 Series	A-2212	....	....	....	....	85029	....	....
HT250US (Models with Remote Shock Mount) (Standard Travel w/ 12" to 14" Ride Height) 85000 Series	A-2212	....	....	....	....	85029	....	....
HT250US (Models with Remote Shock Mount) (Standard Travel w/ 5.5" to 6.5" Ride Height) 85000 Series	B-23650	....	....	....	....	85052	....	....
HT250US (Models with Remote Shock Mount) (Standard Travel w/ 7.5" to 9" Ride Height -High Damping) 85000 Series	B-23743	....	....	....	....	85938	....	....
HT250US (Models with Remote Shock Mount) (Standard Travel w/ 7.5" to 9" Ride Height) 85000 Series	B-23649	....	....	....	....	85064	....	....
HT250US (Models with Standard Shock Mount) (Extended Rebound w/ 6.5" Ride Height -High Damping) 85000 Series	B-24579	....	....	....	....	85939	....	....
HT250US (Models with Standard Shock Mount) (Extended Rebound w/ 6.5" Ride Height) 85000 Series	B-23651	....	....	....	....	85045	....	....
HT250US (Models with Standard Shock Mount) (Standard Travel w/ 3.5" to 4" Ride Height) 85000 Series	B-23548	....	....	....	....	85079	....	....
HT250US (Models with Standard Shock Mount) (Standard Travel w/ 5.5" to 6.5" Ride Height) 85000 Series	B-23650	....	....	....	....	85052	....	....
HT250US (Models with Standard Shock Mount) (Standard Travel w/ 7.5" to 14" Ride Height -High Damping) 85000 Series	B-23743	....	....	....	....	85938	....	....
HT250US (Models with Standard Shock Mount) (Standard Travel w/ 7.5" to 14" Ride Height) 85000 Series	B-23649	....	....	....	....	85064	....	....
HT300U & N-HT300U (All except Models listed below) 85000 Series	A-20126	....	....	....	....	85323	....	....
HT300U & N-HT300U (All except Models listed below) 89000 Series	A-20126	....	....	....	....	....	89436	....
HT300U & N-HT300U (U-7.5-519,U-9-011,U-9-519,U-12-011,U-12-015,U-14-011,U-14-015,U-17-011) 87000 Series	B-21699	....	....	....	....	87018	....	....
T-12-139 85000 Series	A-2213	....	....	....	....	85010	....	....
T-23-US-9-011 85000 Series	A-2213	....	....	....	....	85010	....	....
T-4-392 85000 Series	A-2160	....	....	....	....	85014	....	....
T-6-062, -295, -370, -422 85000 Series	A-1667	....	....	....	....	85000	....	....
T-6-062, -295, -370, -422 89000 Series	A-1667	....	....	....	....	....	89436	....
T-6-071 85000 Series	A-2212	....	....	....	....	85029	....	....
T-9-084 85000 Series	A-2240	....	....	....	....	85013	....	....
T-9-084 89000 Series	A-2240	....	....	....	....	....	89414	....
T-9-106, -278, -313 85000 Series	A-4084	....	....	....	....	85005	....	....
T-9-106, -278, -313 89000 Series	A-4084	....	....	....	....	....	89430	....
T-9-175 85000 Series	A-2160	....	....	....	....	85014	....	....
T-9-325 85000 Series	A-2218	....	....	....	....	85030	....	....
T-9-325 89000 Series	A-2218	....	....	....	....	....	89440	....
T-9-390 85000 Series	A-2213	....	....	....	....	85010	....	....
T30-US-9, -17 85000 Series	A-10348	....	....	....	....	85043	....	....

### VANTRAX

HKA180 Heavy Duty 85000 Series	S-24088 B-24088	....	....	....	....	85000	....	....
HKA180 Heavy Duty 89000 Series	S-24088 B-24088	....	....	....	....	....	89436	....



# APPLICATION GUIDE

Year	Fitment Notes	OEM#	 Fleetline    GasSLX		 Fleetline    GasSLX    Cab Shock\ Specialty Shock		

## HENDRICKSON TRAILER SUSPENSION SYSTEMS

## HENDRICKSON TRAILER SUSPENSION SYSTEMS

### VANTRAAX (cont)

	HKA180 Standard 83000 Series	S-24088 B-24088					83389		
	HKA180 Standard 89000 Series	S-24088 B-24088						89436	
	HKA200 85000 Series	B-23566 S-23566					85000		
	HKA200 89000 Series	B-23566 S-23566						89436	
	HKA250 (Standard) 85000 Series	B-24023					85738		
	HKAL 46K Models 85000 Series	B-23566					85000		
	HKAL 46K Models 89000 Series	B-23566						89436	
	HKANT 40K Heavy Duty 85000 Series	S-24088 B-24088					85000		
	HKANT 40K Heavy Duty 89000 Series	S-24088 B-24088						89436	
	HKANT 40K Standard 83000 Series	S-24088 B-24088					83389		
	HKANT 40K Standard 89000 Series	S-24088 B-24088						89436	
	HKANT 46K 85000 Series	B-23566 S-23566					85000		
	HKANT 46K 89000 Series	B-23566 S-23566						89436	
	HKANT 69K23 85000 Series	S-23566					85000		
	HKANT 69K23 89000 Series	S-23566						89436	
	HKARL 46K Disc Brake Applications 85000 Series	S-25436 B-25436					85916		
	HKARL 46K Disc Brake Applications 89000 Series	S-25436 B-25436						89430	
	HKARL 46K Drum Brake Applications 85000 Series	B-23566 S-23566					85000		
	HKARL 46K Drum Brake Applications 89000 Series	B-23566 S-23566						89436	
	HKAT 46K 85000 Series	B-23566 S-23566					85000		
	HKAT 46K 89000 Series	B-23566 S-23566						89436	
	HKAT 50K 85000 Series	B-24023 S-24023					85738		
	HKAT 69K 85000 Series	B-24023 S-24023					85738		
	HKAT 69K23 Models 85000 Series	B-23566 S-23566					85000		
	HKAT 69K23 Models 89000 Series	B-23566 S-23566						89436	

## HENDRICKSON TRUCK SUSPENSION SYSTEMS

## HENDRICKSON TRUCK SUSPENSION SYSTEMS

### ADDITIONAL APPLICATIONS

	Conventional Hino Models with Hendrickson Comfort Air Suspension 83000 Series	60670-020					83148		
	HAS 460 Suspensions with O.E.M. Number 85000 Series	60675-12					85638		
	Hendrickson Rear Air Suspension used on Conventional Hino Models ( 23,000 lb Capacity) 83000 Series	60670-018					83166		
	HMX 400/460 Haulmax with 16.5" Saddle Height 83000 Series	60680-004L 60680-004					83143		
	HMX 400/460 Haulmax with 17.5" or 18.5" Saddle Height 83000 Series	60680-005L 60680-005					83142		
	HTS 210 For Spartan Chassis (Type C School Bus Applications) 85000 Series	60665-025 60665-025L					85036		
	HTS 210 For Spartan Chassis (Type C School Bus Applications) 89000 Series	60665-025 60665-025L						89405	

# APPLICATION GUIDE

Year	Fitment Notes	OEM#					
			Fleetline	GasSLX	Fleetline	GasSLX	Cab Shock Specialty Shock

## HENDRICKSON TRUCK SUSPENSION SYSTEMS

## HENDRICKSON TRUCK SUSPENSION SYSTEMS

### ADDITIONAL APPLICATIONS (cont)

MaxAir / AL-405 Models 83000 Series	57241-006 57241-006L	....	....	83111	....	....
Parasteer Suspensions Models with O.E.M. Number 85000 Series	60998-002L 60998-002 59483-000 60665-005 60665-005L	85919	....	....	....	....

### AIRTEK - SERIES

Airtek Front Used on BlueBird 85000 Series	58913-009L 58913-008L 58913-007L 58913-008 58913-007 65992-003 58913-009 47170000456	85959	....	....	....	....
Airtek Front Used on Freightliner / Western Star 85000 Series	58913-003L 58913-012L 47170006269 58913-012 58913-003	85932	....	....	....	....
Airtek Front Used on Freightliner / Western Star 89000 Series	58913-003L 58913-012L 47170006269 58913-012 58913-003	....	89453	....	....	....
Airtek Front Used on International 85000 Series	65992-002 65992-002L 65992-001	85955	....	....	....	....
Airtek Front Used on Volvo / Mack 85000 Series	64838-003L 64838-001 64838-002L 64838-001L 64838-002 64838-003	85933	....	....	....	....
Airtek Front Used on Volvo / Mack 89000 Series	64838-003L 64838-001 64838-002L 64838-001L 64838-002 64838-003	....	89454	....	....	....

### ALL AMERICAN SERIES (FE & RE MODELS)

Buses with Hendrickson 14,600 lb Capacity-Left Hand Drive Steertek Axle 85000 Series	58913-011L 58913-011	85959	....	....	....	....
--	-------------------------	-------	------	------	------	------

### COMFORT AIR - SERIES

Conventional Hino Models with Single Axle Air Suspension 83000 Series	60670-017 60670-013	....	....	83148	....	....
Models with O.E.M. Number 85000 Series	471700131545 60998-001 60998-003	....	....	85006	....	....

### FIREMAAX - SERIES

Firemaax 240 Air Suspensions Disc Brake Applications with 8 1/2" to 10" Ride Height 85000 Series	060665-014 60665-014	....	....	85962	....	....
Firemaax 240 Air Suspensions Drum Brake Applications with 8 1/2" to 10" Ride Height 85000 Series	60665-018L 060665-018 60665-018	....	....	85961	....	....
Firemaax 240 Air Suspensions Standard with 12 1/2" - 14 3/8" - 15 1/2" Ride Height 85000 Series	60665-011	....	....	85967	....	....
Firemaax 240 Air Suspensions Standard with 8 1/2" to 10" Ride Height 85000 Series	60657-003 60657-003L	....	....	85072	....	....
Firemaax 270 Air Suspensions Drum Brake Applications with 8 1/2" to 10" Ride Height 85000 Series	60665-013	....	....	85965	....	....
Firemaax 480 Air Suspensions Disc Brake Applications with 8 1/2" to 10" Ride Height 85000 Series	060665-014 60665-014	....	....	85962	....	....
Firemaax 480 Air Suspensions Drum Brake Applications with 8 1/2" to 10" Ride Height 85000 Series	60665-018L 060665-018 60665-018	....	....	85961	....	....
Firemaax 480 Air Suspensions Standard with 12 1/2" - 14 3/8" - 15 1/2" Ride Height 85000 Series	60665-011	....	....	85967	....	....
Firemaax 480 Air Suspensions Standard with 8 1/2" to 10" Ride Height 85000 Series	60657-003 60657-003L	....	....	85072	....	....



# APPLICATION GUIDE

Year	Fitment Notes	OEM#					
			Fleetline	GasSLX	Fleetline	GasSLX	Cab Shock Specialty Shock

## HENDRICKSON TRUCK SUSPENSION SYSTEMS

## HENDRICKSON TRUCK SUSPENSION SYSTEMS







### HAS - SERIES (cont)

HAS - 230 With O.E.M. Number 85000 Series	60675-003 60675-003L				85976	....	....
HAS - 230L 83000 Series	60670-008 60670-008L				83123	....	....
HAS - 230L 89000 Series	60670-008 60670-008L				....	89405	....
HAS - 360 With O.E.M. Number 83000 Series	60670-005				83137	....	....
HAS - 360 With O.E.M. Number 85000 Series	60675-003 60675-003L				85976	....	....
HAS - 400 Mack & Kenworth Air Suspensions 83000 Series	47902-25				83125	....	....
HAS - 400 Standard Inboard Rear 83000 Series	60670-007 60670-007L				83144	....	....
HAS - 400 With O.E.M. Number 83000 Series	60670-005				83137	....	....
HAS - 400 With O.E.M. Number 85000 Series	60675-006 60675-006L				85909	....	....
	60675-003 60675-003L				85976	....	....
HAS - 400L 83000 Series	60670-008 60670-008L				83123	....	....
HAS - 400L 89000 Series	60670-008 60670-008L				....	89405	....
HAS - 402 Standard Inboard Rear 83000 Series	60670-007 60670-007L				83144	....	....
HAS - 402 With O.E.M. Number 83000 Series	60670-005				83137	....	....
HAS - 402 With O.E.M. Number 85000 Series	60675-006 60675-006L				85909	....	....
	60675-003 60675-003L				85976	....	....
HAS - 402L 83000 Series	60670-008 60670-008L				83123	....	....
HAS - 402L 89000 Series	60670-008 60670-008L				....	89405	....
HAS - 40LH With O.E.M. Number 83000 Series	60680-001 60680-001L				83111	....	....
HAS - 40LH With O.E.M. Number 85000 Series	60685-001				85977	....	....
HAS - 460 85000 Series	60675-016 60675-016L				85976	....	....
HAS - 460 Standard Inboard Rear 83000 Series	60670-007 60670-007L				83144	....	....
HAS - 460 With O.E.M. Number 83000 Series	60670-005				83137	....	....
HAS - 460 With O.E.M. Number 85000 Series	60675-006 60675-006L				85909	....	....
	60675-003 60675-003L				85976	....	....
HAS - 460L 83000 Series	60670-008 60670-008L				83123	....	....
HAS - 460L 89000 Series	60670-008 60670-008L				....	89405	....
Models with O.E.M. Number 85000 Series	606758Q				85976	....	....
	60675-014				85978	....	....

### HN - SERIES

HN - 400 Models built between Mar/96 - Sept/97 83000 Series	60680-003L 60680-003				83112	....	....
HN - 400 Models built between Nov/88 - Feb/96 83000 Series	60670-002L 60670-002				83207	....	....
HN - 400 Models built between Nov/88 - Feb/96 89000 Series	60670-002L 60670-002				....	89407	....
HN - 402 Models built between Apr/96 - Dec/04 83000 Series	57241-003 60680-003L 60680-003				83112	....	....
HN - 460 Models built between Mar/96 - Sept/97 83000 Series	57241-003 60680-003L 60680-003				83112	....	....







# APPLICATION GUIDE

Year	Fitment Notes	OEM#					
							
			Fleetline	GasSLX	Fleetline	GasSLX	Cab Shock Specialty Shock

## HENDRICKSON TRUCK SUSPENSION SYSTEMS

## HENDRICKSON TRUCK SUSPENSION SYSTEMS





### HN - SERIES (cont)

	HN - 460 Models built between Nov/88 - Feb/96 83000 Series	60670-002L 60670-002				83207		
	HN - 460 Models built between Nov/88 - Feb/96 89000 Series	60670-002L 60670-002				....	89407	
	HN - 462 Models built between Apr/96 - 2015 83000 Series	57241-003 60680-003L 60680-003				83112		
	HNT - 460 85000 Series	47902-18				85030		
	HNT - 460 89000 Series	47902-18				....	89440	
96-15	HN - 522 83000 Series	60680-003L 60680-003				83112		

### HTB 400 LT - SERIES

	HTB 400LT Rear Air Suspensions 85000 Series	60657-006 60657-011 60657-010				85102		
--	---	-------------------------------------	--	--	---	-------	--	--

### PRIMAAX - SERIES

	230 Air Suspensions For International Models with 9" Ride Height 85000 Series	60657-003 60657-003L				85072		
	230 Air Suspensions Standard with 12 1/2" - 14 3/8" - 15 1/2" Ride Height 85000 Series	60665-011				85967		
	230 Air Suspensions Standard with 8 1/2" to 10" Ride Height 85000 Series	60657-003 60657-003L				85072		
	260 Air Suspensions Drum Brake Applications with 8 1/2" to 10" Ride Height 85000 Series	60665-013				85965		
	460 Air Suspensions For International Models with 9" Ride Height 85000 Series	60657-003 60657-003L				85072		
	460 Air Suspensions Standard with 12 1/2" - 14 3/8" - 15 1/2" Ride Height 85000 Series	60665-011				85967		
	460 Air Suspensions Standard with 8 1/2" to 10" Ride Height 85000 Series	60657-003 60657-003L				85072		
	520 Air Suspensions Drum Brake Applications with 8 1/2" to 10" Ride Height 85000 Series	60665-013				85965		
	690 Air Suspensions For International Models with 9" Ride Height 85000 Series	60657-003 60657-003L				85072		
	690 Air Suspensions Standard with 12 1/2" - 14 3/8" - 15 1/2" Ride Height 85000 Series	60665-011				85967		
	690 Air Suspensions Standard with 8 1/2" to 10" Ride Height 85000 Series	60657-003 60657-003L				85072		
	780 Air Suspensions Drum Brake Applications with 8 1/2" to 10" Ride Height 85000 Series	60665-013				85965		
	EX 232 Air Suspensions Standard with 12 1/2" - 14 3/8" - 15 1/2" Ride Height 85000 Series	60665-011				85967		
	EX 232 Air Suspensions Standard with 8 1/2" to 10" Ride Height 85000 Series	60657-003 60657-003L				85072		
	EX 23KT for Kenworth Models (Standard with 15 1/2" Ride Height) 85000 Series	60665-011L				85967		
	EX 23KT for Kenworth Models (Standard with 15 1/2" Ride Height) 85000 Series	60665-011				85967		
	EX 262 Air Suspensions Drum Brake Applications with 8 1/2" to 10" Ride Height 85000 Series	60665-013				85965		
	EX 26K for Kenworth Models (Standard with 10" Ride Height - Except Tridem) 85000 Series	60665-013L				85965		
	EX 26K for Kenworth Models (Standard with 10" Ride Height - Except Tridem) 85000 Series	60665-013				85965		
	EX 26KT for Kenworth Models (Standard with 15 1/2" Ride Height) 85000 Series	60665-011 60665-011L				85967		
	EX 462 Air Suspensions Standard with 12 1/2" - 14 3/8" - 15 1/2" Ride Height 85000 Series	60665-011				85967		
	EX 462 Air Suspensions Standard with 8 1/2" to 10" Ride Height 85000 Series	60657-003 60657-003L				85072		
	EX 522 Air Suspensions Drum Brake Applications with 8 1/2" to 10" Ride Height 85000 Series	60665-013				85965		
	EX 52K for Kenworth Models (Standard with 10" Ride Height - Except Tridem) 85000 Series	60665-013L 60665-013				85965		
	EX 692 Air Suspensions Standard with 12 1/2" - 14 3/8" - 15 1/2" Ride Height 85000 Series	60665-011				85967		



# APPLICATION GUIDE

Year	Fitment Notes	OEM#					
			Fleetline	GasSLX	Fleetline	GasSLX	Cab Shock\ Specialty Shock

## HINO

## HINO

### FF3020

03	FF Models Trucks with O.E.M. Number 83000 Series	48500-1941	OIO	83141	....	....	....	....
98-02	FF Models Trucks with O.E.M. Number	48500-1941	OIO	83141	....	....	....	....

### L7

22-24	Models with Hendrickson Comfort Air (Single Axle - 21K & 23K) 83000 Series	60670-018 60670-030L 60670-030 48530-E0290 60670-018L	OIO	....	....	83166	....	....
	Models with O.E.M. Number 83000 Series	48500-E0420	OIO	83391	....	....	....	....

### L8

22-23	Models with Hendrickson Comfort Air (Single Axle - 21K & 23K) 83000 Series	60670-018 60670-030L 60670-030 48530-E0290 60670-018L	OIO	....	....	83166	....	....
-------	--	---	-----	------	------	-------	------	------

### SG SERIES

86	SG221 Tractor 83000 Series	48500-1941	OIO	83141	....	....	....	....
----	----------------------------	------------	-----	-------	------	------	------	------

### SG19

86-91	SG19	48500-1941	OIO	83141	....	....	....	....
-------	------	------------	-----	-------	------	------	------	------

### SG20

92	SG20	48500-1941	OIO	83141	....	....	....	....
----	------	------------	-----	-------	------	------	------	------

### SG22

86	SG22 Straight Truck	48500-1941	OIO	83141	....	....	....	....
----	---------------------	------------	-----	-------	------	------	------	------

### SG23

87-92	SG23 Straight Truck	48500-1941	OIO	83141	....	....	....	....
-------	---------------------	------------	-----	-------	------	------	------	------

### SG231

89-92	SG231 Tractor	48500-1941	OIO	83141	....	....	....	....
-------	---------------	------------	-----	-------	------	------	------	------

### SG3320

98-02	SG Models Trucks with O.E.M. Number	S4850-01941 48500-1941	OIO	83141	....	....	....	....
93-97	SG3320 (SG4H)	48500-1941	OIO	83141	....	....	....	....

### SG3323

93-97	SG3323 (SG1H) Straight Truck	48500-1941	OIO	83141	....	....	....	....
-------	------------------------------	------------	-----	-------	------	------	------	------

### SG5523

93-96	SG5523 (SG1HD) Tractor	48500-1941	OIO	83141	....	....	....	....
-------	------------------------	------------	-----	-------	------	------	------	------

### XL7

22-23	Models with Hendrickson Comfort Air (Single Axle - 21K & 23K) 83000 Series	60670-018 60670-030L 60670-030 48530-E0290 60670-018L	OIO	....	....	83166	....	....
21	Models with Hendrickson Comfort Air (Single Axle - 21K & 23K)	60670-018 60670-030L 60670-030 48530-E0290 60670-018L	OIO	....	....	83166	....	....

### XL8

22-23	Models with Hendrickson Comfort Air (Single Axle - 21K & 23K) 83000 Series	60670-018 60670-030L 60670-030 48530-E0290 60670-018L	OIO	....	....	83166	....	....
-------	--	---	-----	------	------	-------	------	------



# APPLICATION GUIDE

Year	Fitment Notes	OEM#					
			Fleetline	GasSLX	Fleetline	GasSLX	Cab Shock Specialty Shock

## HINO

## HINO

### XL8 (cont)

21	Models with Hendrickson Comfort Air (Single Axle - 21K & 23K)	60670-018 60670-030L 60670-030 48530-E0290 60670-018L	....	....	83166	....	....
	Models with Hendrickson Comfort Air (Tandem Axle - 46K)	60670-018 60670-030L 60670-030 48530-E0290 60670-018L	....	....	83166	....	....

## HOBBS TRAILER

## HOBBS TRAILER

### VARIOUS

	Models with O.E.M. Number 85000 Series	680117	....	....	85300	....	....
	Models with O.E.M. Number 89000 Series	680117	....	....	....	89419	....

## HOLIDAY RAMBLER

## HOLIDAY RAMBLER

### ADMIRAL

11-15	MotorHomes with Ford F53 Chassis with 16,000 lb GVW to 22,000 lb GVW 83000 Series	ASH-1229 ASH-1228 9U94-18045-AA ASH-1205 AT-620 ASH-1022 1C34-18045-AA ASH-294 9U9Z-18124-A ASH-25822 ASH-25823 1C34-18045-JA AT-766	83209	....	....	....	....
		ASH-1206 9U94-18080-AA AT-621 ASH-25824 9U9Z-18125-A ASH-1023 ASH-1230 ASH-137	....	....	83122	....	....
	MotorHomes with Ford F53 Chassis with 16,000 lb GVW to 22,000 lb GVW 89000 Series	ASH-1229 ASH-1228 9U94-18045-AA ASH-1205 AT-620 ASH-1022 1C34-18045-AA ASH-294 9U9Z-18124-A ASH-25822 ASH-25823 1C34-18045-JA AT-766	....	89414	....	....	....
		ASH-1206 9U94-18080-AA AT-621 ASH-25824 9U9Z-18125-A ASH-1023 ASH-1230 ASH-137	....	....	89406	....	....
02-06	MotorHomes with Ford F53 Chassis with 16,000 lb GVW to 22,000 lb GVW 83000 Series	ASH-1229 ASH-1228 9U94-18045-AA ASH-1205 AT-620 ASH-1022 1C34-18045-AA ASH-294 9U9Z-18124-A ASH-25822 ASH-25823 1C34-18045-JA AT-766	83209	....	....	....	....
		ASH-1206 9U94-18080-AA AT-621 ASH-25824 9U9Z-18125-A ASH-1023 ASH-1230 ASH-137	....	....	83122	....	....

# APPLICATION GUIDE

Year	Fitment Notes	OEM#					
			Fleetline	GasSLX	Fleetline	GasSLX	Cab Shock\ Specialty Shock

## HOLIDAY RAMBLER

### ADMIRAL (cont)

02-06	MotorHomes with Ford F53 Chassis with 16,000 lb GVW to 22,000 lb GVW 89000 Series	ASH-1229 ASH-1228 9U94-18045-AA ASH-1205 AT-620 ASH-1022 1C34-18045-AA ASH-294 9U9Z-18124-A ASH-25822 ASH-25823 1C34-18045-JA AT-766	OIO	89414				
		ASH-1206 9U94-18080-AA AT-621 ASH-25824 9U9Z-18125-A ASH-1023 ASH-1230 ASH-137	OIO	89406				

## HOLIDAY RAMBLER



### CLASS A MOTORHOMES

04-11	Models with Workhorse W20 , W22, & W24 MotorHome Chassis with O.E.M. Number 85000 Series	W0005663 F4-BE5-F325-HO 24-153256	OIO					
98-11	Models with Workhorse W20 , W22, & W24 MotorHome Chassis with O.E.M. Number 85000 Series	24-153249 F4-BE5-B492-HO W0005662 W0006254 24153249 24-186629 F4-BE5-A832-MO F4-BE5-F324-HO	OIO	85125				
00-03	Models with Roadmaster Chassis RM4C or used on Ambassador 83000 Series	01809924	OIO	83144				
	Models with Roadmaster Chassis RM4C or used on Ambassador 85000 Series	01809923	OIO			85029		
95-99	MotorHomes with Freightliner XC Chassis (22,000 to 26,000 lb GVW) 83000 Series	.....	OIO	83160				
	MotorHomes with Freightliner XC Chassis (22,000 to 26,000 lb GVW) 85000 Series	.....	OIO			85029		

### ENDEAVOR

15	MotorHomes with Ford F53 Chassis with 16,000 lb GVW to 22,000 lb GVW 83000 Series	ASH-1229 ASH-1228 9U94-18045-AA ASH-1205 AT-620 ASH-1022 1C34-18045-AA ASH-294 9U9Z-18124-A ASH-25822 ASH-25823 1C34-18045-JA AT-766	OIO	83209				
		ASH-1206 9U94-18080-AA AT-621 ASH-25824 9U9Z-18125-A ASH-1023 ASH-1230 ASH-137	OIO	83122				
	MotorHomes with Ford F53 Chassis with 16,000 lb GVW to 22,000 lb GVW 89000 Series	ASH-1229 ASH-1228 9U94-18045-AA ASH-1205 AT-620 ASH-1022 1C34-18045-AA ASH-294 9U9Z-18124-A ASH-25822 ASH-25823 1C34-18045-JA AT-766	OIO	89414				

# APPLICATION GUIDE

Year	Fitment Notes	OEM#					
			Fleetline	GasSLX	Fleetline	GasSLX	Cab Shock Specialty Shock

## HOLIDAY RAMBLER

### ENDEAVOR (cont)

## HOLIDAY RAMBLER

15	MotorHomes with Ford F53 Chassis with 16,000 lb GVW to 22,000 lb GVW 89000 Series	ASH-1206 9U94-18080-AA AT-621 ASH-25824 9U9Z-18125-A ASH-1023 ASH-1230 ASH-137	....	....	OO	....	89406	....
----	---	---	------	------	----	------	-------	------

### VACATIONER

10	MotorHomes with Ford F53 Chassis with 16,000 lb GVW to 22,000 lb GVW 83000 Series	ASH-1229 ASH-1228 9U94-18045-AA ASH-1205 AT-620 ASH-1022 1C34-18045-AA ASH-294 9U9Z-18124-A ASH-25822 ASH-25823 1C34-18045-JA AT-766	OO	83209	....	....	....	....
		ASH-1206 9U94-18080-AA AT-621 ASH-25824 9U9Z-18125-A ASH-1023 ASH-1230 ASH-137	....	....	OO	83122	....	....
	MotorHomes with Ford F53 Chassis with 16,000 lb GVW to 22,000 lb GVW 89000 Series	ASH-1229 ASH-1228 9U94-18045-AA ASH-1205 AT-620 ASH-1022 1C34-18045-AA ASH-294 9U9Z-18124-A ASH-25822 ASH-25823 1C34-18045-JA AT-766	OO	....	89414	....	....	....
08	MotorHomes with Ford F53 Chassis with 16,000 lb GVW to 22,000 lb GVW 83000 Series	ASH-1229 ASH-1228 9U94-18045-AA ASH-1205 AT-620 ASH-1022 1C34-18045-AA ASH-294 9U9Z-18124-A ASH-25822 ASH-25823 1C34-18045-JA AT-766	OO	83209	....	....	....	....
		ASH-1206 9U94-18080-AA AT-621 ASH-25824 9U9Z-18125-A ASH-1023 ASH-1230 ASH-137	....	....	OO	83122	....	....
	MotorHomes with Ford F53 Chassis with 16,000 lb GVW to 22,000 lb GVW 89000 Series	ASH-1229 ASH-1228 9U94-18045-AA ASH-1205 AT-620 ASH-1022 1C34-18045-AA ASH-294 9U9Z-18124-A ASH-25822 ASH-25823 1C34-18045-JA AT-766	OO	....	89414	....	....	....

# APPLICATION GUIDE

Year	Fitment Notes	OEM#					
			Fleetline	GasSLX	Fleetline	GasSLX	Cab Shock Specialty Shock

## HOLIDAY RAMBLER

### VACATIONER (cont)

08	MotorHomes with Ford F53 Chassis with 16,000 lb GVW to 22,000 lb GVW 89000 Series	ASH-1206 9U94-18080-AA AT-621 ASH-25824 9U9Z-18125-A ASH-1023 ASH-1230 ASH-137	...	...	...	89406	...	...
----	---	---	-----	-----	-----	-------	-----	-----

### VARIOUS

	Models with Neway Trailer Air Suspension 83000 Series	90044794	...	...	O	83127	...	...
--	---	----------	-----	-----	---	-------	-----	-----

## HOLLAND-BINKLEY

## HOLLAND-BINKLEY

	Air Plus Integrated Air Susp. with ProPar Parallel Spindle Axles 83000 Series	6898	...	...	O	83125	...	...
	Holland ProPar NT2 Air Suspension 85000 Series	680298	...	...	O	85321	...	...

## HUTCHENS SUSPENSION

## HUTCHENS SUSPENSION

	Models with O.E.M. Number 83000 Series	9423-00	...	...	O	83203	...	...
	Models with O.E.M. Number 89000 Series	9423-00	...	...	O	89436	...	...

## IC CORPORATION

## IC CORPORATION

### AE SCHOOL BUS

	AE Model School Buses with O.E.M. Number 83000 Series	3902993C1 3902993C2 3902993C3	O	83135	...	...	...	...
--	---	-------------------------------------	---	-------	-----	-----	-----	-----

### BE SCHOOL BUS

08-15	School Buses with 7,000 lb Front Axles	3605735C1 3605735C2	O	83169	...	...	...	...
	School Buses with O.E.M. Number	3609400C1 3609400C2	I	83317	...	...	...	...

### CE SCHOOL BUS

10-23	CE Model School Buses (71 Capacity) with 9,000 to 10,000 lb Front Suspension	6127088C1 OE13402S 3578105C2 3578105C1	O	83163	...	...	...	...
	CE Model School Buses with 20,000 lb International IROS Air Suspension	6127713C2 3578858C2 6127713C1	O	...	...	85656	...	...
20-21	CE Model School Buses with 17,000 lb - 22,000 lb rear suspension	4164142C1	I	...	...	83244	...	...
13-18	CE Model School Buses with 6,000 to 8,000 lb Front Axles	3533356C3	O	83169	...	...	...	...
16-17	CE Model School Buses with 20,000 lb Rear Air Suspension	3601600C3	O	...	...	85082	...	...
10-13	CE Model School Buses with 22,000 lb Rear Spring Suspension	501906C91 501906C92 OE13424S	I	...	...	83317	...	...
06-09	CE Model School Buses (71 Capacity) with 9,000 to 10,000 lb Front Suspension 83000 Series	6127088C1 OE13402S 3578105C2 3578105C1	O	83163	...	...	...	...
05-09	CE Model School Buses with 22,000 lb Rear Spring Suspension 83000 Series	501906C91 501906C92 OE13424S	I	...	...	83317	...	...

### RE SCHOOL BUS

	Low-Profile models with O.E.M. Number 83000 Series	1660846C92	O	...	...	83101	...	...
	RE Model School Buses with O.E.M. Number 85000 Series	2018987C1 501553C91 1675455C1	O	...	...	85003	...	...
	RE Model School Buses with O.E.M. Number 89000 Series	2018987C1 501553C91 1675455C1	O	...	...	89411	...	...
03-18	RE Model School Buses (Low Profile)	537524C91	O	...	...	83123	89405	...
	RE Model School Buses with 12,000 to 14,000 lb Front Axles	2200327C1	I	85332	...	...	...	...
	RE Model School Buses with O.E.M number	3604282C1	I	85351	...	...	...	...

# APPLICATION GUIDE

Year	Fitment Notes	OEM#					
			Fleetline	GasSLX	Fleetline	GasSLX	Cab Shock Specialty Shock

## IC CORPORATION

## IC CORPORATION

### RE SCHOOL BUS (cont)

03-18	RE Model School Buses with O.E.M. Number	472412C91		83456	89447			
-------	--	-----------	--	-------	-------	--	--	--

## INGERSALL MACHINE

## INGERSALL MACHINE

### VARIOUS

	700060-0 Axle Assy. Specialty Shock	665472						
	Models with O.E.M. Number Specialty Shock	665904						

## INGERSOLL AXLES

## INGERSOLL AXLES

	Ingersoll part number 85000 Series	653511-03						
		653511-04						
		653511-01						
		653511-02						
	Ingersoll part number 89000 Series	653511-01						

## INTERNATIONAL

## INTERNATIONAL

### 4000 SERIES

	4600, 4700, 4800, 4900 Models with Link Cab Suspension 83000 Series	2012769C2						
		1201-1044						
	Cabover Tractors with 74", 84" or 88" cabs with Link Cabmate Model IHB-2P 83000 Series	1202-0032						
	Conventional Tractors with Link Cabmate Model IHC43 83000 Series	1201-0012 1202-0012						

### 4300

20	Models with 6,000 to 8,000 lb Front Suspension	3533356C1 3533356C2		83135				
	Models with Hendrickson HAS - 230 or 460 Rear Air Suspension	60675-003 H60675-003 3514952C1 60675-003L 57905-001						
	Models with O.E.M. Number	2509223C92 2509223C91 2509221C91						
15	Models with 12,000 lb Front axle	3533357C1 3533357C2 3533357C3		85957				
	Models with 6,000 to 8,000 lb Front Suspension	3533356C1 3533356C2		83135				
	Models with Hendrickson HAS - 230 or 460 Rear Air Suspension	60675-003 H60675-003 3514952C1 60675-003L 57905-001						
	Models with O.E.M. Number	2509223C92 2509223C91 2509221C91						

### 4300LP

19	Models with O.E.M. Number	2509223C92 2509223C91 2509221C91						
10	Models with O.E.M. Number	2509223C92 2509223C91 2509221C91						
02-08	Models with O.E.M. Number	2509223C92 2509223C91 2509221C91						

### 4400

02-20	Models with 6,000 to 8,000 lb Front Suspension	3533356C1 3533356C2		83135				
-------	--	------------------------	--	-------	--	--	--	--

# APPLICATION GUIDE

Year	Fitment Notes	OEM#					
			Fleetline	GasSLX	Fleetline	GasSLX	Cab Shock\ Specialty Shock

## INTERNATIONAL

### 4400 (cont)

02-20	Models with Hendrickson HAS - 230 or 460 Rear Air Suspension	60675-003 H60675-003 3514952C1 60675-003L 57905-001								
	Models with O.E.M. Number	2509223C92 2509223C91 2509221C91								83054
02-15	Models with 12,000 lb Front axle	3533357C1 3533357C2 3533357C3	OIO	85957						
02-13	Models with 22,000 lb Rear Spring Suspension	501906C91 501906C92 OE13424S					-O	83317		
08-09	Models with 9,000 to 10,000 lb Front Suspension	6127088C1 3578105C2	OIO	83163						
	Models with International 40,000 lb Rear Air Suspension	3549099C2					OIO	85923	89458	

### 4400LP

10-19	Models with O.E.M. Number	2509223C92 2509223C91 2509221C91					OIO			83054
02-05	Models with O.E.M. Number	2509223C92 2509223C91 2509221C91					OIO			83054

### 5000 SERIES

96-16	Paystar - SFA Conventionals with Link Cabmate Model NP50 & NP50-A built after August of 1996 From 09/96 83000 Series	1201-1044 1202-1044					OIO			83025
94-16	Paystar - SBA Conventionals with Link Cabmate Model NP50 & NP50-A built after August of 1994 From 9/94 83000 Series	1201-1044 1202-1044					OIO			83025

### 5600I

99-14	Models with 16,000 lb to 20,000 lb Front axle	4070336C1 1667520C1	OIO	85058	89431					
	Models with Hendrickson HN - 402 Rear Suspension	3515265C1 3515265C2 60680-003L 60680-003 H60680-003					-O	83112		

### 5900I

00-17	Models with 46,000 lb Hendrickson Rear Air Suspension	60657-003 H60657-003 3626571C1 60657-003L					OIO	85072		
	Models with Hendrickson HMX 400/460 Haulmax with 16.5" Saddle	60680-004L 60680-004 H60680-004					-O	83143		
00-12	Models with 16,000 lb to 20,000 lb Front axle	1667520C1	OIO	85058	89431					
00-09	Models with 46,000 lb Neway Rear Air Suspension	2029200C91 90044626					OIO	83126	89430	

### 7000 SERIES

	7300, 7400, 7500 & 7600 Models with Link Cabmate Suspensions with O.E.M. Number 83000 Series	1201-1049 1201-1043					OIO			83025
	7600 Model trucks with day cab or extended cabs with Link Cabmate Model IDC76 83000 Series	1201-9010 2509224C91					OIO			83053

### 7300

02-20	Models trucks with day cab or extended cabs with Link Cabmate Model IDC7345	1201-9008 2509223C91					OIO			83054
	Models with Hendrickson HAS - 230 or 460 Rear Air Suspension	60675-003 H60675-003 3514952C1 60675-003L 57905-001					OIO	85976		
	Models with Hendrickson HMX 400/460 Haulmax with 16.5" Saddle	60680-004L 60680-004 H60680-004					-O	83143		
02-16	Models with 12,000 lb Front axle	3576464C2 3533357C1 3576464C1 3533357C2 3533357C3	OIO	85957						

## INTERNATIONAL





# APPLICATION GUIDE

Year	Fitment Notes	OEM#					
			Fleetline	GasSLX	Fleetline	GasSLX	Cab Shock\ Specialty Shock

## INTERNATIONAL

### 7600 (cont)

03-07	Models with Hendrickson HMX 400/460 Haulmax with 16.5" Saddle	60680-004L 60680-004 H60680-004	...	...	O	83143	...	...
-------	---	---------------------------------------	-----	-----	---	-------	-----	-----

### 7700

05-07	Models with Hendrickson HAS - 230 or 460 Rear Air Suspension	60675-003 H60675-003 3514952C1 60675-003L 57905-001	...	...	O	85976	...	...
	Models with Hendrickson HMX 400/460 Haulmax with 16.5" Saddle	60680-004L 60680-004 H60680-004	...	...	O	83143	...	...

## 8000 SERIES

	8100, 8200, & 8300 Model Trucks with Link Cabmate with O.E.M. Number 83000 Series	1201-1213	...	...	O	...	...	83005
	8100, 8200, & 8300 Model Trucks with O.E.M. Number 83000 Series	2012769C1	...	...	O	...	...	83005
		2012768C1 2025790C1	...	...	O	...	...	83013
	8600 Model trucks with day cab or extended cabs with Link Cabmate Model IDC86 83000 Series	1201-9011	...	...	O	...	...	83053

## 8500

02-07	Model trucks with day cab or extended cabs with Link Cabmate Model IDC85	1201-9008 2509223C91	...	...	O	...	...	83054
	Models with 10,000 to 14,000 lb Front axle	3588209C1 3588209C2 3533357C1 3533357C2 3533357C3	O	85957	...	...	...	...
	Models with International 40,000 lb Rear Air Suspension	3549099C1 3549099C3 3549099C2	...	...	O	85923	89458	...

## 8500 TRANSTAR

08-11	Model trucks with day cab or extended cabs with Link Cabmate Model IDC85	1201-9008 2509223C91	...	...	O	...	...	83054
	Models with 10,000 to 14,000 lb Front axle	3588209C1 3588209C2 3533357C1 3533357C2 3533357C3	O	85957	...	...	...	...
08-09	Models Tractors with 36" Sleepers	1201-9011 2509222C91	...	...	O	...	...	83053
	Models with International 40,000 lb Rear Air Suspension	3549099C1 3549099C3 3549099C2	...	...	O	85923	89458	...

## 8600

03-07	Tractors with O.E.M. Number 83000 Series	1201-9008 2509223C91	...	...	O	...	...	83054
-------	--	-------------------------	-----	-----	---	-----	-----	-------

## 8600 SBA

03-07	Models with O.E.M. Number	1201-9008 2509223C91	...	...	O	...	...	83054
-------	---------------------------	-------------------------	-----	-----	---	-----	-----	-------

## 8600 TRANSTAR

12-18	Models with O.E.M. Number	2595314C1 2600491C91	...	...	O	...	...	83062
08-18	Models with O.E.M. Number	1201-9008 2509223C91	...	...	O	...	...	83054
14-17	Models with O.E.M. Number	6127086C1	O	85637	...	...	...	...
08-11	Models with 10,000 to 14,000 lb Front axle	3588209C1 3588209C2 3533357C1 3533357C2 3533357C3	O	85957	...	...	...	...
08-09	Models Tractors with 36" Sleepers	1201-9011 2509222C91	...	...	O	...	...	83053
	Models with International 40,000 lb Rear Air Suspension	3549099C1 3549099C3 3549099C2	...	...	O	85923	89458	...

# APPLICATION GUIDE

Year	Fitment Notes	OEM#					
			Fleetline	GasSLX	Fleetline	GasSLX	Cab Shock Specialty Shock

## INTERNATIONAL

### 9000 SERIES

	9200 Models with O.E. Number 83000 Series	2023684C1	....	....	☉	....	....	83015
	9300 & 9400 Conventional Tractors with Link Cabmate Model IHC93-A 83000 Series	2503529C1 1202-1043	....	....	☉	....	....	83025
97-18	9100 & 9200 Models Conventional with Link Cabmate Model ND92-A From 03/97 83000 Series	1202-1043	....	....	☉	....	....	83025
93-18	48" & 60" Bentz Sleepers on 9000 Models Conventional Tractors with Link Cabmate Model IHS4860 From 01/93 83000 Series	1201-1044 1202-1044	....	....	☉	....	....	83025
04-09	Models With 51" Low-Roof Sleeper 83000 Series	2585145C1 1201-0154	....	....	☉	....	....	83051
	Models with 72" High-Roof Sleeper 83000 Series	1201-0254 2589922C1	....	....	☉	....	....	83051

## INTERNATIONAL

### 9100I

	Models with Pro Sleepers 85000 Series	4164152C1	☉	85924	....	....	....	....
	Models with Pro Sleepers 89000 Series	4164152C1	☉	....	89457	....	....	....

### 9200 SBA

00	Models with 12,000 lb Front Axle	6127705C1 3584535C3 3581107C1 3581107C3 3581107C2	☉	85924	89457	....	....	....
----	----------------------------------	---	---	-------	-------	------	------	------

### 9200I

	Models with Pro Sleepers 85000 Series	4164152C1	☉	85924	....	....	....	....
	Models with Pro Sleepers 89000 Series	4164152C1	☉	....	89457	....	....	....

### 9200I SBA

07-11	Models with Day Cab & Hendrickson AirTek Suspension	65992-002 3660549C1 65992-002L 3613984C1	☉	85955	....	....	....	....
	Models with Sleeper Cab & Hendrickson AirTek Suspension	3660548C1 65992-001L 3609178C1 65992-001	☉	85955	....	....	....	....
04-09	All models with 40,000 lb Rear Air Suspension	3586883C1	☉	....	....	85931	89458	....
00-09	Models with 12,000 lb Front Axle	6127705C1 3584535C3 3581107C1 3581107C3 3581107C2	☉	85924	89457	....	....	....

### 9300

00	Models with 12,000 lb Front Axle	3584535C3 3581107C1 3581107C3 3581107C2	☉	85924	89457	....	....	....
----	----------------------------------	--	---	-------	-------	------	------	------

### 9400

00	Models with 12,000 lb Front Axle	3584535C3 3581107C1 3581107C3 3581107C2	☉	85924	89457	....	....	....
----	----------------------------------	--	---	-------	-------	------	------	------

### 9400I

	Models with Pro Sleepers 85000 Series	4164152C1	☉	85924	....	....	....	....
	Models with Pro Sleepers 89000 Series	4164152C1	☉	....	89457	....	....	....

### 9400I SBA

07-11	Models with Day Cab & Hendrickson AirTek Suspension	65992-002 3660549C1 65992-002L 3613984C1	☉	85955	....	....	....	....
	Models with Sleeper Cab & Hendrickson AirTek Suspension	3660548C1 65992-001L 3609178C1 65992-001	☉	85955	....	....	....	....
04-09	All models with 40,000 lb Rear Air Suspension	3586883C1	☉	....	....	85931	89458	....

# APPLICATION GUIDE

Year	Fitment Notes	OEM#					
			Fleetline	GasSLX	Fleetline	GasSLX	Cab Shock Specialty Shock

## INTERNATIONAL

### 9400I SBA (cont)

00-09	Models with 12,000 lb Front Axle	3584535C3 3581107C1 3581107C3 3581107C2	OIO	85924	89457	....	....	....
-------	----------------------------------	--	-----	-------	-------	------	------	------

### 9700

89-96	Cabovers with 89" & 110" cabs with Link Cabmate Model NAV9876	1202-0054	OIO	....	....	....	....	83021
	Models with 89" or 110" cabs with Link Cabmate Models IH9789 or IH97110	1202-0032	OIO	....	....	....	....	83016

### 9800 SBA

96-99	Cabovers with 89" & 110" cabs with Link Cabmate Model NAV9876	1202-0054	OIO	....	....	....	....	83021
-------	---	-----------	-----	------	------	------	------	-------

### 9900I

13-18	Models with 12,000 lb Front axle	3810581C3 3810581C4	OIO	85995	....	....	....	....
00-18	Models with Hendrickson HAS - 230 or 460 Rear Air Suspension	60675-003 H60675-003 3514952C1 60675-003L 57905-001	OIO	....	....	85976	....	....
14-16	Models with Sleeper Cab and 14,000 to 16,000 lb Taperleaf Front Spring Suspension	3977759C2	OIO	85639	....	....	....	....
04-09	All models with 40,000 lb Rear Air Suspension	3586883C1	OIO	....	....	85931	89458	....
	Models with 12,000 lb Front Axle	3584535C3	OIO	85924	89457	....	....	....

### 9900I SFA

00-03	Models with Hendrickson HAS - 230 or 460 Rear Air Suspension	60675-003 H60675-003 3514952C1 60675-003L	OIO	....	....	85976	....	....
-------	--	--	-----	------	------	-------	------	------

### 9900IX

04-09	All models with 40,000 lb Rear Air Suspension	3586883C1	OIO	....	....	85931	89458	....
	Models with 12,000 lb Front Axle	3584535C3	OIO	85924	89457	....	....	....
00-09	Models with Hendrickson HAS - 230 or 460 Rear Air Suspension	60675-003 H60675-003 3514952C1 60675-003L 57905-001	OIO	....	....	85976	....	....

### 9900IX SFA

01-03	Models with Hendrickson HAS - 230 or 460 Rear Air Suspension	60675-003 H60675-003 3514952C1 60675-003L	OIO	....	....	85976	....	....
-------	--	--	-----	------	------	-------	------	------

## A, B, AC AND BC CONVENTIONAL

	A-140 (4 x 4) Models 83000 Series	....	OIO	....	....	83216	....	....
	A-160, A-170, A-180, AC-160, AC-170, AC-180, B-160, B-170, B-180, BC-160, BC-170, BC-180 Models 83000 Series	453567C91 308650C91 308649C91	OIO	....	....	83216	....	....
	A-170, B-170, AC-170, ACF-170, BC-170, A-180, B-180, AC-180, BC-180, BCF-170 Models 85000 Series	308646C91	OIO	85012	....	....	....	....
	A-170, B-170, AC-170, ACF-170, BC-170, A-180, B-180, AC-180, BC-180, BCF-170 Models 89000 Series	308646C91	OIO	....	89413	....	....	....
	AC-170 & BC-170 (4 x 4) Models 83000 Series	....	OIO	....	....	83216	....	....
	AC-180 & BC-180 (4 x 4) Models 83000 Series	....	OIO	....	....	83216	....	....
	BCF-195-D Models 83000 Series	....	OIO	....	....	83225	....	....
	C-150 Models 83000 Series	453567C91 308649C91	OIO	....	....	83216	....	....
	C-150 Models 85000 Series	308668C91	OIO	85012	....	....	....	....
		453556C91	OIO	....	....	85012	....	....
	C-150 Models 89000 Series	308668C91	OIO	....	89413	....	....	....
		453556C91	OIO	....	....	....	89413	....

# APPLICATION GUIDE

Year	Fitment Notes	OEM#					
			Fleetline	GasSLX	Fleetline	GasSLX	Cab Shock/ Specialty Shock

## INTERNATIONAL

### BE SERIES SCHOOL BUS

BE200 Model School Bus Chassis To 2012 with 9000 lb Rear Suspension 83000 Series	3609400C1 3609400C2	....	....	83317	....	....
--	------------------------	------	------	-------	------	------

### BINDER

S Models Binder 83000 Series	472367C91	83318	....	....	....	....
------------------------------	-----------	-------	------	------	------	------

### CARGOSTAR

CO-190, VCO-190, CO-200, DCO-200, VCO-200, CO-220, VCO-220 With Air Ride Suspension After Chassis No G-387453 85000 Series	350425C1 462557C91	....	....	85300	....	....
CO-190, VCO-190, CO-200, DCO-200, VCO-200, CO-220, VCO-220 With Air Ride Suspension After Chassis No G-387453 89000 Series	350425C1 462557C91	....	....	....	89419	....
CO-1950 with Air Ride Suspension After Chassis No. G-387453 85000 Series	350425C1 462557C91	....	....	85300	....	....
CO-1950 with Air Ride Suspension After Chassis No. G-387453 89000 Series	350425C1 462557C91	....	....	....	89419	....

### CE SERIES SCHOOL BUS

13-18	CE Model School Buses with 6,000 to 8,000 lb Front Axles 83000 Series	6127688C1	83169	....	....	....
10-18	CE Model School Buses with 20,000 lb International IROS Air Suspension 85000 Series	3578858C2 6127713C1	....	....	85656	....
05-13	CE Model School Buses with 22,000 lb Rear Spring Suspension 83000 Series	501906C92 OE13424S	....	....	83317	....

### CO-TRANSTAR AND TRANSTAR II

7070B, F-7070B, CO-7070B & COF-7070B Models 85000 Series	477132C1 426744R91 426744R92 453576C91 453576C92	85303	....	....	....	....
7070B, F-7070B, CO-7070B & COF-7070B Models 89000 Series	477132C1 426744R91 426744R92 453576C91 453576C92	....	89422	....	....	....
CO-4010, COF-4010, COT-4010, COT-4010D, CO-4050, COF-4050, COT-4050, CO-4040A & B, CO-4070D, COF-4070B, COF-4070D, COT-4070D, COF-4077, COF-4077A, COF-4080D, CO-4090A, COF-4090A 85000 Series	477132C1 426744R91 426744R92 453576C91 453576C92	85303	....	....	....	....
CO-4010, COF-4010, COT-4010, COT-4010D, CO-4050, COF-4050, COT-4050, CO-4040A & B, CO-4070D, COF-4070B, COF-4070D, COT-4070D, COF-4077, COF-4077A, COF-4080D, CO-4090A, COF-4090A 89000 Series	477132C1 426744R91 426744R92 453576C91 453576C92	....	89422	....	....	....
CO-4070A, COF-4070A, COF-4090A with Rear Suspension 85000 Series	462557C91	....	....	85300	....	....
CO-4070A, COF-4070A, COF-4090A with Rear Suspension 89000 Series	462557C91	....	....	....	89419	....

### CO9670

81-88	Cabovers with 89" & 110" cabs with Link Cabmate Model NAV9876	1202-0054	....	....	....	83021
	Models with 89" or 110" cabs with Link Cabmate Models IH967-A or IH97110	1202-0032	....	....	....	83016

### COF9670

81-88	Models with 89" or 110" cabs with Link Cabmate Models IH967-A or IH97110	1202-0032	....	....	....	83016
-------	--	-----------	------	------	------	-------

### CV515

23	Models with 11K, 13.5K or 15.5K VARI-RATE Rear Suspension	4208946C1 4206863C1	....	....	83398	....
	Models with 4 x 4 Rear	4109458C2	....	....	83243	....
	Models with IROS Rear	4214011C2	....	....	85670	....
	Models with Taperleaf Front	4109582C1 4089293C1 4109583C1 4207304C1	83397	....	....	....

### CXT SERIES

CXT Models with 9,000 to 10,000 lb Front Suspension 83000 Series	3606770C2 3606770C1	83163	....	....	....	....
--	------------------------	-------	------	------	------	------

# APPLICATION GUIDE

Year	Fitment Notes	OEM#					
			Fleetline	GasSLX	Fleetline	GasSLX	Cab Shock\ Specialty Shock

## INTERNATIONAL

### DURASTAR - 4300, 4400 SERIES

	Models with 20,000 lb International IROS Air Suspension To 2015 85000 Series	3578858C1 3578858C2		....	....		85656	....	....
	Models with O.E.M. Number 85000 Series	6127690C1		....	....		85923	....	....
	Models with O.E.M. Number 89000 Series	6127690C1		....	....		....	89458	....
16-20	Models with 11,000 lb to 14,000 lb Front axle 85000 Series	6127714C1		85928	....		....	....	....
16-19	Models with 20,000 lb International IROS Air Suspension 85000 Series	6127713C1		....	....		85656	....	....
13-18	Models with 6,000 to 8,000 lb Front Suspension 83000 Series	6127688C1 3533356C3		83169	....		....	....	....
10-15	Models with 12,000 lb Front axle 85000 Series	3533357C1 3533357C2 3533357C3		85957	....		....	....	....
10-12	Models with 6,000 to 8,000 lb Front Suspension 83000 Series	3533356C1 3533356C2		83135	....		....	....	....
	School Bus models with 6,000 to 8,000 lb Front Suspension 83000 Series	3533356C1 3533356C2		83135	....		....	....	....
10-11	Models with 40,000 lb Rear Air Suspension 85000 Series	3549099C2		....	....		85923	....	....
	Models with 40,000 lb Rear Air Suspension 89000 Series	3549099C2		....	....		....	89458	....

## INTERNATIONAL

### EMV607

23	Models with 12,000 lb Parabolic Taper Leaf Springs 85000 Series	6127714C1		85928	....		....	....	....
----	---	-----------	--	-------	------	--	------	------	------

### F & S SERIES

	1600, 1700, 1800, 1900, 2100 Models 83000 Series	3000070C91		83456	....		....	....	....
	1600, 1700, 1800, 1900, 2100 Models 85000 Series	453576C92		85303	....		....	....	....
	1600, 1700, 1800, 1900, 2100 Models 89000 Series	453576C92		....	89422		....	....	....
		3000070C91		....	89447		....	....	....
	1600, 1700, 1800, 1900, 2100 Models with International Air Suspension 85000 Series	1690035C1 2018987C1 2018987C2 501553C91 1675455C1		....	....		85003	....	....
	1600, 1700, 1800, 1900, 2100 Models with International Air Suspension 89000 Series	1690035C1 2018987C1 2018987C2 501553C91 1675455C1		....	....		....	89411	....
	1600, 1700, 1800, 1900, 2100 Models with Neway ARD-234 Air Suspension 83000 Series	537524C91		....	....		83123	....	....
	1600, 1700, 1800, 1900, 2100 Models with Neway ARD-234 Air Suspension 89000 Series	537524C91		....	....		....	89405	....
	1624, 1654, 1724, 1754, 1824, 1854, 1924, F1924, 1925, 1954, F1954, 1955, 2124, 2125, F2125, 2154, 2155 Models Exc. with Rear Axle Codes 14029, 14030, 14187 83000 Series	501905C91		....	....		83301	....	....
		501906C91		....	....		83317	....	....
	1624, 1654, 1724, 1754, 1824, 1854, 1924, F1924, 1925, 1954, F1954, 1955, 2124, 2125, F2125, 2154, 2155 Models with 5000, 6000 or 7500 lb Front Axle 83000 Series	472367C91		83318	....		....	....	....
	1624, 1654, 1724, 1754, 1824, 1854, 1924, F1924, 1925, 1954, F1954, 1955, 2124, 2125, F2125, 2154, 2155 Models with Rear Axle Codes 14029, 14030, 14187 83000 Series	501905C91		....	....		83301	....	....
	1624, 1654, 1724, 1754, 1824, 1854, 1924, F1924, 1925, 1954, F1954, 1955, 2124, 2125, F2125, 2154, 2155, 2275, F2275, 2524, F2524, 2554, F2554, 2574, F2574, 2575, F2575, F2624, F2654, F2674 Models with 9000, 10800 or 12000 lb Front Axle 83000 Series	472412C91 472411C91 586724C91		83456	....		....	....	....
	1624, 1654, 1724, 1754, 1824, 1854, 1924, F1924, 1925, 1954, F1954, 1955, 2124, 2125, F2125, 2154, 2155, 2275, F2275, 2524, F2524, 2554, F2554, 2574, F2574, 2575, F2575, F2624, F2654, F2674 Models with 9000, 10800 or 12000 lb Front Axle 89000 Series	472412C91 472411C91 586724C91		....	89447		....	....	....
	1924, 1954 (6 x 6) Models 83000 Series	472414C91 472367C91		83318	....		....	....	....
	2275, F2275, 2524, F2524, 2554, F2554, 2574, F2574, 2575, F2575, F2624, F2654, F2674 Models with International Corporate Air Suspension 85000 Series	1690035C1 2018987C1 2018987C2 501553C91 1675455C1		....	....		85003	....	....

# APPLICATION GUIDE

Year	Fitment Notes	OEM#					

## INTERNATIONAL

### F & S SERIES (cont)

2275, F2275, 2524, F2524, 2554, F2554, 2574, F2574, 2575, F2575, F2624, F2654, F2674 Models with International Corporate Air Suspension 89000 Series	1690035C1 2018987C1 2018987C2 501553C91 1675455C1	...	...	...	...	...	89411	...	...
2275, F2275, 2524, F2524, 2554, F2554, 2574, F2574, 2575, F2575, F2624, F2654, F2674 Models with Neway ARD-125/244 Air Suspension 83000 Series	790335C91	...	...	...	...	83209	...	...	...
2275, F2275, 2524, F2524, 2554, F2554, 2574, F2574, 2575, F2575, F2624, F2654, F2674 Models with Neway ARD-125/244 Air Suspension 89000 Series	790335C91	...	...	...	...	...	89414	...	...
2275, F2275, 2524, F2524, 2554, F2554, 2574, F2574, 2575, F2575, F2624, F2654, F2674 Models with Neway ARD-234 Air Suspension 83000 Series	537524C91	...	...	...	...	83123	...	...	...
2275, F2275, 2524, F2524, 2554, F2554, 2574, F2574, 2575, F2575, F2624, F2654, F2674 Models with Neway ARD-234 Air Suspension 89000 Series	537524C91	...	...	...	...	...	89405	...	...
2275, F2275, 2524, F2524, 2554, F2554, 2574, F2574, 2575, F2575, F2624, F2654, F2674 Models with Ridwell Rear Suspension 85000 Series	534464C1	...	...	...	...	85734	...	...	...

## INTERNATIONAL

### FIRETRUCK

CO-8190 83000 Series	467371C91 204994R91 308648C91 453565C91 453561C91	...	...	83225	...	...	...	...	...
Models with O.E.M. Number 85000 Series	210919R91	...	...	...	...	85307	...	...	...

### FLEETSTAR - CONVENTIONAL

1900, F-1900, T-1900, 1950, F-1950, T-1950, 2000, 2000D, F-2000D & T-2000D Models 83000 Series	453568C91 467372C91 210535R91	...	...	83225	...	...	...	...	...
1910A, F-1910A, 2010A, F-2010A, 2050A, F-2050A, 2070A, F-2070A, 2110A & 2150A Models 83000 Series	467984C91 308650C92 206621R92 453570C91	...	...	83216	...	...	...	...	...
2000D, 2010A, 2050A, 2070A, 2110A, 2150A with Air Ride Suspension After Chassis No G-387453 85000 Series	350425C1 462557C91	...	...	...	...	85300	...	...	...
2000D, 2010A, 2050A, 2070A, 2110A, 2150A with Air Ride Suspension After Chassis No G-387453 89000 Series	350425C1 462557C91	...	...	...	...	89419	...	...	...
2000D, 2010A, 2050A, 2070A, 2110A, 2150A with Air Ride Suspension Before Chassis No G-387453 85000 Series	350426C1	...	...	...	...	85734	...	...	...
F-2010A, F-2050A, F-2000D with Air Ride Suspension 85000 Series	350425C1 462557C91	...	...	...	...	85300	...	...	...
F-2010A, F-2050A, F-2000D with Air Ride Suspension 89000 Series	350425C1 462557C91	...	...	...	...	89419	...	...	...
R-185, R-190, RD-190, R-200, RD-200, RF-200, RDF-200, R-220, RD-220, R210 & RF-210 83000 Series	453568C91 467372C91 467371C91 210536R91 453562C91 210533R91 210534R92 210538R91 210537R91 210535R91	...	...	83225	...	...	...	...	...

### HV607

19-23	Models with 11,000 lb to 14,000 lb Taper-leaf Springs	6127714C1	...	...	85928	...	...	...	...
	Models with Hendrickson HMX 400/460 Haulmax with 16.5" Saddle	60680-004L 60680-004	...	...	...	...	83143	...	...
	Models with Hendrickson HMX 400/460 Haulmax with 17.5" & 18.5" Saddle	60680-005L HDR60680-005 60680-005	...	...	...	...	83142	...	...
	Models with Hendrickson Primaax 230/460 Air Suspension with 9" Ride Height	60657-003 3626571C2 60657-003L	...	...	...	...	85072	...	...
	Models with O.E.M. Number	1201-9008 2509223C92 2509223C91	...	...	...	...	...	...	83054
19-21	Models with 18,000 to 20,000 lb (Set Forward) Front Axle	3868265C1	...	...	85995	...	...	...	...
19-20	Models with 16,000 lb to 23,000 lb Parabolic Taperleaf Springs	3576464C2	...	...	85957	...	...	...	...

# APPLICATION GUIDE

Year	Fitment Notes	OEM#					
			Fleetline	GasSLX	Fleetline	GasSLX	Cab Shock\ Specialty Shock

## INTERNATIONAL

### HV613

19-23	Models with Hendrickson HMX 400/460 Haulmax with 16.5" Saddle	60680-004L 60680-004		....	....	O	83143	....	....
	Models with Hendrickson HMX 400/460 Haulmax with 17.5" & 18.5" Saddle	60680-005L HDR60680-005 60680-005		....	....	O	83142	....	....
	Models with Hendrickson Primaax 230/460 Air Suspension with 9" Ride Height	60657-003 3626571C2 60657-003L		....	....	OO	85072	....	....
19-21	Models with 18,000 to 20,000 lb (Set Forward) Front Axle	3868265C1	OO	85995	....		....	....	....
19-20	Models with 16,000 lb to 23,000 lb Parabolic Taperleaf Springs	3576464C2	OO	85957	....		....	....	....

## INTERNATIONAL

### HX515

17-22	Models with Hendrickson HAS - 230 or 460 Rear Air Suspension	60675-003 H60675-003 3514952C1 60675-003L		....	....	OO	85976	....	....
	Models with Hendrickson HMX 400/460 Haulmax with 16.5" Saddle	60680-004L 60680-004 H60680-004		....	....	O	83143	....	....
	Models with Hendrickson HMX 400/460 Haulmax with 17.5" & 18.5" Saddle	60680-005L HDR60680-005 60680-005		....	....	O	83142	....	....
	Models with Hendrickson Primaax 230/460 Air Suspension with 9" Ride Height	60657-003 60657-003L		....	....	OO	85072	....	....
	Models with Hendrickson Primaax 520 Rear Air Suspension (10" Ride Height-Drum Brakes only)	60665-013		....	....	O	85965	....	....

### HX520

20-24	73" Sleeper, 73" Raised Roof Sleeper Cab	4133258C1		....	....	OO	....	....	83907
24	Models with 12,000 lb to 14,000 lb Parabolic Taperleaf Front Suspension	6119473C2 4164155C1	OO	85058	....		....	....	....
18-23	Day Cab Models with O.E.M. Number	4060267C4		....	....	OO	....	....	83909
	Models with 12,000 lb to 14,000 lb Parabolic Taperleaf Front Suspension	6119473C2 4164155C1	OO	85058	89431		....	....	....
	Models with Hendrickson HAS - 230 or 460 Rear Air Suspension	60675-003 H60675-003 3514952C1 60675-003L		....	....	OO	85976	....	....
	Models with Hendrickson HMX 400/460 Haulmax with 16.5" Saddle	60680-004L 60680-004 H60680-004		....	....	O	83143	....	....
	Models with Hendrickson HMX 400/460 Haulmax with 17.5" & 18.5" Saddle	60680-005L HDR60680-005 60680-005		....	....	O	83142	....	....
	Models with Hendrickson Primaax 230/460 Air Suspension with 9" Ride Height	60657-003 60657-003L		....	....	OO	85072	....	....
18-22	Models with Hendrickson Primaax 520 Rear Air Suspension (10" Ride Height-Drum Brakes only)	60665-013		....	....	O	85965	....	....
18-20	Sleeper Cab Models with O.E.M. Number	4055574C2		....	....	OO	....	....	83907

### HX615

17-22	Models with Hendrickson HAS - 230 or 460 Rear Air Suspension	60675-003 H60675-003 3514952C1 60675-003L		....	....	OO	85976	....	....
	Models with Hendrickson HMX 400/460 Haulmax with 16.5" Saddle	60680-004L 60680-004 H60680-004		....	....	O	83143	....	....
	Models with Hendrickson HMX 400/460 Haulmax with 17.5" & 18.5" Saddle	60680-005L HDR60680-005 60680-005		....	....	O	83142	....	....
	Models with Hendrickson Primaax 230/460 Air Suspension with 9" Ride Height	60657-003 60657-003L		....	....	OO	85072	....	....
	Models with Hendrickson Primaax 520 Rear Air Suspension (10" Ride Height-Drum Brakes only)	60665-013		....	....	O	85965	....	....

### HX620

17-24	Day Cab Models with O.E.M. Number	4060267C4		....	....	OO	....	....	83909
-------	-----------------------------------	-----------	--	------	------	----	------	------	-------



# APPLICATION GUIDE

Year	Fitment Notes	OEM#					
				Fleetline	GasSLX		Fleetline

## INTERNATIONAL

### HX620 (cont)

17-24	Models with Hendrickson HAS - 230 or 460 Rear Air Suspension	60675-003 H60675-003 3514952C1 60675-003L	....	....		85976	....	....
	Models with Hendrickson HMX 400/460 Haulmax with 16.5" Saddle	60680-004L 60680-004 H60680-004	....	....		83143	....	....
	Models with Hendrickson HMX 400/460 Haulmax with 17.5" & 18.5" Saddle	60680-005L HDR60680-005 60680-005	....	....		83142	....	....
	Models with Hendrickson Primaax 230/460 Air Suspension with 9" Ride Height	60657-003 60657-003L	....	....		85072	....	....
17-22	Models with Hendrickson Primaax 520 Rear Air Suspension (10" Ride Height-Drum Brakes only)	60665-013	....	....		85965	....	....
17-20	Sleeper Cab Models with O.E.M. Number	4055574C2	....	....		....	....	83907

## INTERNATIONAL

### LOADSTAR - CONVENTIONAL

	1600, 1600 (4x4), 1610, 1610 (4x4), 1610FC, 1700, 1700 (4x4), 1710, 1710 (4x4), F-1700, 1750, 1800, 1810, F-1800, F-1800-D, 1850, F-1850, 1890 & 1890-D with 9000, 10800 or 12000 lb Front Axle 85000 Series	471201C91 467983C91 360444C91 329316C92 453564C91		85012	....		....	....	
	1600, 1600 (4x4), 1610, 1610 (4x4), 1610FC, 1700, 1700 (4x4), 1710, 1710 (4x4), F-1700, 1750, 1800, 1810, F-1800, F-1800-D, 1850, F-1850, 1890 & 1890-D with 9000, 10800 or 12000 lb Front Axle 89000 Series	471201C91 467983C91 360444C91 329316C92 453564C91		....	89413	....		....	....
	1600, 1600 (4x4), 1610, 1610 (4x4), 1610FC, 1700, 1700 (4x4), 1710, 1710 (4x4), F-1700, 1750, 1800, 1810, F-1800, F-1800-D, 1850, F-1850, 1890 & 1890-D with Axle Codes 02089, 02091 83000 Series	453567C91 206620R91 308649C91		83216	....	....		....	....
	1600, 1600 (4x4), 1610, 1610 (4x4), 1700, 1700 (4x4), 1710, 1710 (4x4), 1750, 1800, 1810, 1850, 1890 & 1890-D Models 83000 Series	453567C91 467984C91 308650C92 206621R91 206620R91 453570C91 308649C91		....	....	83216		....	....
		471203C91 474002C91 453575C91 873622C91 383379C91		....	....	83308		....	....
	1600, 1600 (4x4), 1610, 1610 (4x4), 1700, 1700 (4x4), 1710, 1710 (4x4), 1750, 1800, 1810, 1850, 1890 & 1890-D Models 85000 Series	467983C91 360444C91 329316C92 453564C91		....	....	85012		....	....
	1600, 1600 (4x4), 1610, 1610 (4x4), 1700, 1700 (4x4), 1710, 1710 (4x4), 1750, 1800, 1810, 1850, 1890 & 1890-D Models 89000 Series	467983C91 360444C91 329316C92 453564C91		....	....	89413		....	....
	1600, 1600 (4x4), 1610, 1610 (4x4), 1700, 1700 (4x4), 1710, 1710 (4x4), F-1700, 1750, 1800, 1810, F-1800, F-1800-D, 1850, F-1850, 1890 & 1890-D Exc. Axle Codes 02054, 02057, 02059, 02089, 02091, 02098, 02101, 02109, 02139, 02208, 02218, 02228, 02309, 0232 85000 Series	453556C91 874695R92 874695R91 467985C91 308668C92		85012	....	....		....	....
	1600, 1600 (4x4), 1610, 1610 (4x4), 1700, 1700 (4x4), 1710, 1710 (4x4), F-1700, 1750, 1800, 1810, F-1800, F-1800-D, 1850, F-1850, 1890 & 1890-D Exc. Axle Codes 02054, 02057, 02059, 02089, 02091, 02098, 02101, 02109, 02139, 02208, 02218, 02228, 02309, 0232 89000 Series	453556C91 874695R92 874695R91 467985C91 308668C92		....	89413	....		....	....
	1600, 1610FC, 1700, 1700 (4x4), 1800, 1890, 1890D Models 83000 Series	462753C91 384435C91 453571C91		....	....	83216		....	....
	1700, 1750, 1800, 1850 Models with Air Ride Suspension 85000 Series	462557C91		....	....	85300		....	....
	1700, 1750, 1800, 1850 Models with Air Ride Suspension 89000 Series	462557C91		....	....	89419		....	....
	M1600, M1700, M1800, M1900, M2100 Models 85000 Series	453576C92		85303	....	....		....	....
	M1600, M1700, M1800, M1900, M2100 Models 89000 Series	453576C92		....	89422	....		....	....

### LONESTAR

17-23	Models with International 40,000 lb Rear Air Suspension (52" Spacing- Heavy Duty Rear)	4069435C1	....	....		85642	....	....
	Sleeper Cab Models with O.E.M. Number	4055574C2	....	....		....	....	83907



# APPLICATION GUIDE

Year	Fitment Notes	OEM#					
			Fleetline	GasSLX	Fleetline	GasSLX	Cab Shock Specialty Shock

## INTERNATIONAL

### METRO & MULTI-SHOP SERIES (cont)

	M1600, MC1600, M1700 & MC1700 85000 Series	453556C91 874695R91 874696R91 308669C91 308668C91	OIO	85012	....				
	M1600, MC1600, M1700 & MC1700 89000 Series	453556C91 874695R91 874696R91 308669C91 308668C91	OIO	....	89413				
	MA1200, M1400, M1500, MA1500 85000 Series	453556C91 308669C91		....	....	OIO	85012	....	....
	MA1200, M1400, M1500, MA1500 89000 Series	453556C91 308669C91		....	....	OIO	....	89413	....

## INTERNATIONAL

### MV

20	Models with 20,000 lb International IROS Air Suspension	6127713C2		....	....				
	Models with 9,000 to 10,000 lb Front Suspension	6127088C1	OIO	83163	....				
	Models with Hendrickson HAS - 230 or 460 Rear Air Suspension	60675-003 H60675-003 3514952C1 60675-003L		....	....	OIO	85976	....	....

### MV607

23-24	Models with 11,000 lb to 14,000 lb Taper-leaf Springs	6127714C1	OIO	85928	....				
	Models with 6,000 to 8,000 lb Front Suspension	4164146C1 6127688C1	OIO	83169	....				
	Models with International 21,000 lb Rear Air Suspension	6127666C1		....	....	OIO	85642	....	....

### PAYSTAR

	Models with 12,000 to 14,000 Front Axle 85000 Series	4164155C1	OIO	85058	....				
	Models with 12,000 to 14,000 Front Axle 89000 Series	4164155C1	OIO	....	89431				

### PAYSTAR - 5000 SERIES

	5010, F-5010, F-5050, F-5050SF, 5070, F-5070, F-5070SF Models 85000 Series	477132C1 426744R91 426744R92 453576C91 453576C92	OIO	85303	....				
	5010, F-5010, F-5050, F-5050SF, 5070, F-5070, F-5070SF Models 89000 Series	477132C1 426744R91 426744R92 453576C91 453576C92	OIO	....	89422				
	5900 SB Models with Hendrickson Primaax 230, 460 and 690 Air Suspension (8-1/2" to 10" Ride Height) To 2018 85000 Series	60657-003 60657-003L		....	....	OIO	85072	....	....
	5900 SB Models with Hendrickson Primaax EX 232, 462 and 692 Air Suspension (8-1/2" to 10" Ride Height) To 2018 85000 Series	60657-003 60657-003L		....	....	OIO	85072	....	....
	Models with 10,000 to 16,000 lb Front Suspension 85000 Series	3576465C1 3576465C2 3816234C1		OIO	85929	....			
	Models with 14,000 lb Front axle 85000 Series	3596878C2 4070352C1		OIO	85648	....			
	Models with O.E.M. Number 85000 Series	6127690C1		....	....	OIO	85923	....	....
	Models with O.E.M. Number 89000 Series	6127690C1		....	....	OIO	....	89458	....
10-15	5900 SB Models with 46,000 lb Hendrickson Rear Air Suspension 85000 Series	H60657-003 3626571C1		....	....	OIO	85072	....	....
10-13	Models with Hendrickson HMX 400/460 Haulmax with 16.5" Saddle 83000 Series	60680-004L 60680-004		....	....	OIO	83143	....	....
10-11	5900i Models with 12,000 lb - 14,000 lb Front axle 85000 Series	2015556C1	OIO	85316	....				
	5900i Models with 12,000 lb - 14,000 lb Front axle 89000 Series	2015556C1	OIO	....	89426				

### PROSTAR

	Day Cab Models with O.E.M. Number 85000 Series	3737576C1		....	....				
	Day Cab Models with O.E.M. Number 89000 Series	3737576C1		....	....	OIO	85931	....	....

# APPLICATION GUIDE

Year	Fitment Notes	OEM#					
				Fleetline	GasSLX		Fleetline

## INTERNATIONAL

### PROSTAR (cont)

	Models with 12,350 lb Front Mono Leaf Spring Suspension To 2013 85000 Series	3610198C1		85963	....				
	Models with Day Cab and 12,000 to 14,000 lb Taperleaf Front Spring Suspension To 2015 85000 Series	3812837C1		85954	....				
		3606859C1							
		3737574C1							
	3606859C3			85994	....				
	Models with Day Cab and Air Suspension 85000 Series	3610199C1		85964	....				
	Models with Hendrickson HTB 400LT Rear Air Suspension 85000 Series	60657-006 H60657-006 60657-011 H60657-011 60657-010 H60657-010		....	....		85102	....	....
	Models with O.E.M. Number 85000 Series	3668566C1		85954	....				
		3821760C1		....	....		85931	....	....
		3688729C1							
		3688732C1							
	Models with O.E.M. Number 89000 Series	3821760C1		....	....		....	89458	....
		3688729C1							
		3688732C1							
	Models with Sleeper Cab and 12,350 lb Leaf Spring Suspension To 2014 85000 Series	3606857C2		85954	....				
		3606857C1							
	Models with Sleeper Cab with O.E.M. Number 85000 Series	3737575C1		85954	....				
21	6 x 4 Models with O.E.M. Number 85000 Series	6127666C1		....	....		85642	....	....
	Models with 113" Sleeper Cab 85000 Series	3810581C3		85995	....				
		3810581C4							
		3806341C4							
		3806341C3							
	Sleeper Cabs with 12,000 lb - 13,200 lb Mono-Leaf Spring Suspension 85000 Series	4050443C2		85994	....				
		4050443C1							
17-20	6 x 4 Models with O.E.M. Number	6127666C1		....	....		85642	....	....
16-20	Sleeper Cabs with 12,000 lb - 13,200 lb Mono-Leaf Spring Suspension	4050443C2		85994	....				
		4050443C1							
13-20	Models with 113" Sleeper Cab	3810581C3		85995	....				
		3810581C4							
		3806341C4							
		3806341C3							
08-20	Models with Hendrickson HAS - 230 or 460 Rear Air Suspension	60675-003 H60675-003 3514952C1 60675-003L 57905-001		....	....		85976	....	....
09-18	Models with 12,350 lb Front Mono Leaf Spring Suspension	3813341C4		85963	....				
		3813341C3							
16-17	Models with Day Cab and 12,000 - 14,000 lb Taperleaf Front Spring Suspension	4050444C2		85994	....				
		4050444C1							
09-17	All models with 40,000 lb Rear Air Suspension	3620395C1		....	....		85931	89458	....
		4050340C1							
		4050340C2							
11-16	Models With 56" or 72" Hi Roof Sleeper	2595314C1		....	....		....	....	83062
		2593803C91							
14-15	Models with Sleeper Cab and 12,350 lb Leaf Spring Suspension	3606857C3		85994	....				

### RH613

18-24	Models with International 40,000 lb Rear Air Suspension	6127666C1		....	....				
	RH-613 Models with 12,000 lb - 13,200 lb Mono-Leaf Spring Suspension	4050443C2		85994	....				
18-20	Models With 56" Hi Roof Sleeper	2595314C1		....	....		....	....	83062
	RH Models with 12,000 - 14,000 lb Taperleaf Spring Suspension	4050444C2		85994	....				

### S SERIES SCHOOL BUS

	1603, 1703, 1803 & 1853 with Axle Codes 02089, 02091 83000 Series	453567C91 467984C91 206620R91 308649C91		83216	....				
--	---	--	--	-------	------	--	--	--	--

# APPLICATION GUIDE

Year	Fitment Notes	OEM#					
			Fleetline	GasSLX	Fleetline	GasSLX	Cab Shock/ Specialty Shock

## INTERNATIONAL

### S SERIES SCHOOL BUS (cont)

## INTERNATIONAL

1603, 1703, 1803 & 1853 - Exc. Axle Codes 02054, 02057, 02059, 02089, 02091, 02098, 02101, 02109, 02139, 02208, 02218, 02228, 02309, 02329, 02339 85000 Series	453556C91 874695R91 467985C91 308668C92	OO	85012	....				
1603, 1703, 1803 & 1853 - Exc. Axle Codes 02054, 02057, 02059, 02089, 02091, 02098, 02101, 02109, 02139, 02208, 02218, 02228, 02309, 02329, 02339 89000 Series	453556C91 874695R91 467985C91 308668C92	OO	....	89413				
1603, 1703, 1803 & 1853 83000 Series	453567C91 308650C92 206621R91 206620R91 453570C91 308649C91	OO	....	....	83216	....	....	....
	471203C91 474002C91 453575C91 873622C91 383379C91	OO	....	....	83308	....	....	....
1603, 1703, 1803 & 1853 85000 Series	471201C91	OO	85012	....	....	....	....	
	467983C91 306444C91 329316C92 453564C91	OO	....	....	85012	....	....	
1603, 1703, 1803 & 1853 89000 Series	471201C91	OO	....	89413	....	....	....	
	467983C91 306444C91 329316C92 453564C91	OO	....	....	89413	....	....	
1603, 1703, 1803 & 1853 with 9000, 10800 or 12000 lb Front Axle 85000 Series	320444C91 467983C91 329316C92 453564C91	OO	85012	....	....	....	....	
1603, 1703, 1803 & 1853 with 9000, 10800 or 12000 lb Front Axle 89000 Series	320444C91 467983C91 329316C92 453564C91	OO	....	89413	....	....	....	
1723 S Models with 5000, 6000 or 7500 lb Front Axle 83000 Series	472367C91	IT	83318	....	....	....	....	
1723, 1823, 1853 Models with International Air Suspension 85000 Series	1690035C1 2018987C1 2018987C2 501553C91 1675455C1	OO	....	....	85003	....	....	
1723, 1823, 1853 Models with International Air Suspension 89000 Series	1690035C1 2018987C1 2018987C2 501553C91 1675455C1	OO	....	....	89411	....	....	
1723, 1823, 1853 Models with Neway ARD-234 Air Suspension 83000 Series	537524C91	OO	....	....	83123	....	....	
1723, 1823, 1853 Models with Neway ARD-234 Air Suspension 89000 Series	537524C91	OO	....	....	89405	....	....	
173 FC & 183 FC with Axle Codes 14149 & 14189 83000 Series	453568C91 467372C91 210535R91	OO	....	....	83225	....	....	
173 FC & 183 FC - Exc. Axle Codes 14149 & 14189 83000 Series	210918R91	OO	....	....	83215	....	....	
173 FC & 183 FC - Exc. Axle Codes 14149 & 14189 85000 Series	453574C91	OO	....	....	85307	....	....	
173 FC, 183 FC, 183RE, 193 RE, 1853 FC & 1853 DFC 83000 Series	467371C91 204994R91 308648C91 453565C91 453561C91	OO	83225	....	....	....	....	
1823 S Models - Exc. with Rear Axle Codes 14029, 14030, 14187 83000 Series	501906C91	IT	....	....	83317	....	....	
1823, 1853 S Models with 9000, 10800 or 12000 lb Front Axle 83000 Series	472412C91 472411C91 586724C91	IT	83456	....	....	....	....	
1823, 1853 S Models with 9000, 10800 or 12000 lb Front Axle 89000 Series	472412C91 472411C91 586724C91	IT	....	89447	....	....	....	
183 RE Models with Axle Codes 14043, 14147 & 14186 83000 Series	467371C91 453562C91 210533R91 210534R92	OO	....	....	83225	....	....	

# APPLICATION GUIDE

Year	Fitment Notes	OEM#					
			Fleetline	GasSLX	Fleetline	GasSLX	Cab Shock Specialty Shock

## INTERNATIONAL

### S SERIES SCHOOL BUS (cont)

1853 DFC3 85000 Series	453579C91 210920R91	O O	85308	....			
1853 DFC3 89000 Series	453579C91 210920R91	O O	....	89422			
1853 FC & 1853 DFC with Axle Code 14136 85000 Series	453574C91 308664C91 210919R91		....	....	O O	85307	....
1853 FC & 1853 DFC with Axle Code 14149 with FD Serial Numbers 83000 Series	453567C91		....	....	O O	83216	....
1853 FC & 1853 DFC with Axle Codes 14039, 14139, 14149 & 14189 - Exc. 14149 with FD Serial Numbers 83000 Series	467371C91 453562C91 210533R91 210534R92		....	....	O O O	83225	....
1853 FC & 1853 DFC with Axle Codes 14044, 14045, 14060, 14145, 14146, 14150 and 14186 85000 Series	453574C91 208664C91 210919R91		....	....	O O	85307	....
193 RE Models - Exc. Axle Codes 14039 & 14189 83000 Series	467371C91 453562C91 210533R91 210534R92		....	....	O O O	83225	....
193 RE Models 85000 Series	453579C91 210920R91	O O	85308	....		....	....
193 RE Models 89000 Series	453579C91 210920R91	O O	....	89422		....	....
RE Models 85000 Series	3604282C1	O	85351	....		....	....

## INTERNATIONAL

### SERIES 1000 FORWARD CONTROL CHASSIS

1452, 1652 Models 83000 Series	472412C91 586724C91	I I	83456	....			
1452, 1652 Models 89000 Series	472412C91 586724C91	I I	....	89447			
1452, 1652 Models with International Air Suspension 85000 Series	1690035C1 2018987C1 2018987C2 501553C91 1675455C1		....	....	O O	85003	....
1452, 1652 Models with International Air Suspension 89000 Series	1690035C1 2018987C1 2018987C2 501553C91 1675455C1		....	....	O O	....	89411
1452, 1652 Models with MOR-RYDE Rear Suspension 83000 Series	1663471C1 548532C1		....	....	I I	83103	....
M1400, M1600 Models 83000 Series	472412C91 586724C91	I I	83456	....		....	....
	501905C91		....	....	I O	83301	....
M1400, M1600 Models 89000 Series	472412C91 586724C91	I I	....	89447		....	....

### SERIES 3000 - SCHOOL BUS CHASSIS

3000, 3400 Models with 10,000 to 14,000 lb Front axle 85000 Series	3533357C1 3533357C2 3533357C3	O O	85957	....			
3000, 3400 Models with 6,000 to 8,000 lb Front axle 83000 Series	3533356C1 3533356C2	O O	83135	....			
3700, 3800 Models 83000 Series	472412C91 586724C91	I I	83456	....		....	....
	501905C91		....	....	I O	83301	....
	501906C91		....	....	I O	83317	....
3700, 3800 Models 89000 Series	472412C91 586724C91	I I	....	89447		....	....
3700, 3800 Models with International Air Suspension 85000 Series	1690035C1 2018987C1 2018987C2 501553C91 1675455C1		....	....	O O	85003	....
3700, 3800 Models with International Air Suspension 89000 Series	1690035C1 2018987C1 2018987C2 501553C91 1675455C1		....	....	O O	....	89411
3700, 3800 Models with MOR-RYDE Rear Suspension 83000 Series	548532C1		....	....	I I	83103	....







# APPLICATION GUIDE

Year	Fitment Notes	OEM#					
			Fleetline	GasSLX	Fleetline	GasSLX	Cab Shock/ Specialty Shock

## INTERNATIONAL

### SERIES 9100, 9100I - TRACTOR & STRAIGHT TRUCK (cont)

Models with International Air Suspension (Except Lo-Profile) 85000 Series	2018987C1 2018987C2	....	....	85003	....	....
Models with International Air Suspension (Except Lo-Profile) 89000 Series	2018987C1 2018987C2	....	....	....	89411	....

## INTERNATIONAL

### SERIES 9200, 9200I - TRACTOR & STRAIGHT TRUCK

4 X 2 Models with International Air Suspension 85000 Series	2018987C1 2018987C2	....	....	85003	....	....
4 X 2 Models with International Air Suspension 89000 Series	2018987C1 2018987C2	....	....	....	89411	....
6 X 4 Models with 12,000 to 14,000 lb Front Axles 85000 Series	3581109C4 3581109C3	O	85924	....	....	....
6 X 4 Models with 12,000 to 14,000 lb Front Axles 89000 Series	3581109C4 3581109C3	O	....	89457	....	....
6 X 4 Models with International Air Suspension 85000 Series	2018987C1 2018987C2	....	....	85003	....	....
6 X 4 Models with International Air Suspension 89000 Series	2018987C1 2018987C2	....	....	....	89411	....
6 X 4 Models with International Air Suspension For Lo-Profile 83000 Series	1660846C91 1660846C92	....	....	83101	....	....
6 X 4 Models with Neway AD-246-10 Air Suspension and 60" Axle Spacing Heavy Duty 85000 Series	2029200C91 AMS600172	....	....	85030	....	....
6 X 4 Models with Neway AD-246-10 Air Suspension and 60" Axle Spacing Heavy Duty 89000 Series	2029200C91 AMS600172	....	....	....	89440	....
6 X 4 Models with Neway AD-246-10 Air Suspension and 60" Axle Spacing Standard 83000 Series	2029200C91 AMS600172	....	....	83126	....	....
6 X 4 Models with Neway AD-246-10 Air Suspension and 60" Axle Spacing Standard 89000 Series	2029200C91 AMS600172	....	....	....	89430	....
Models with 12,000 - 18,000 lb Suspension 85000 Series	1664788C2 2015556C1 2032533C1	I	85316	....	....	....
Models with 12,000 - 18,000 lb Suspension 89000 Series	1664788C2 2015556C1 2032533C1	I	....	89426	....	....
Models with Hendrickson HA-460 Models Air Suspension 85000 Series	AMS600102	....	....	85005	....	....
Models with Hendrickson HA-460 Models Air Suspension 89000 Series	AMS600102	....	....	....	89430	....
Models with IAS Suspension w/ 9.25" or 9.5" Ride Height 85000 Series	3573265C1	....	....	85931	....	....
Models with IAS Suspension w/ 9.25" or 9.5" Ride Height 89000 Series	3573265C1	....	....	....	89458	....
Models with International Air Suspension 85000 Series	1690035C1 501553C91 1675455C1	....	....	85003	....	....
Models with International Air Suspension 89000 Series	1690035C1 501553C91 1675455C1	....	....	....	89411	....

### SERIES 9300, 9300I, 9400 & 9400I LONG HOOD CONV.

6 X 4 Models with International Air Suspension Exc. Lo-Profile 85000 Series	2018987C1 2018987C2	....	....	85003	....	....
6 X 4 Models with International Air Suspension Exc. Lo-Profile 89000 Series	2018987C1 2018987C2	....	....	....	89411	....
6 X 4 Models with International Air Suspension For Lo-Profile 83000 Series	1660846C91 1660846C92	....	....	83101	....	....
6 X 4 Models with Neway AD-246-10 Air Suspension and 60" Axle Spacing Heavy Duty 85000 Series	2029200C91 AMS600172	....	....	85030	....	....
6 X 4 Models with Neway AD-246-10 Air Suspension and 60" Axle Spacing Heavy Duty 89000 Series	2029200C91 AMS600172	....	....	....	89440	....
6 X 4 Models with Neway AD-246-10 Air Suspension and 60" Axle Spacing Standard 83000 Series	2029200C91 AMS600172	....	....	83126	....	....
6 X 4 Models with Neway AD-246-10 Air Suspension and 60" Axle Spacing Standard 89000 Series	2029200C91 AMS600172	....	....	....	89430	....
Models with 10,800 lb Suspension 83000 Series	503610C2	O	83207	....	....	....
Models with 10,800 lb Suspension 89000 Series	503610C2	O	....	89407	....	....
Models with 12,000 - 14,000 lb Suspension 85000 Series	1664788C2 2015556C1 2032533C1	I	85316	....	....	....

# APPLICATION GUIDE

Year	Fitment Notes	OEM#					
				Fleetline	GasSLX		Fleetline

## INTERNATIONAL

### SERIES 9300, 9300I, 9400 & 9400I LONG HOOD CONV. (cont)

Models with 12,000 - 14,000 lb Suspension 89000 Series	1664788C2 2015556C1 2032533C1		....	89426		....	....	....
Models with 16,000 - 18,000 lb Suspension 85000 Series	1667520C1		85058	....		....	....	....
Models with 16,000 - 18,000 lb Suspension 89000 Series	1667520C1		....	89431		....	....	....
Models with Hendrickson HA-460 Models Air Suspension 85000 Series	AMS600102		....	....		85005	....	....
Models with Hendrickson HA-460 Models Air Suspension 89000 Series	AMS600102		....	....		....	89430	....
Models with IAS Suspension w/ 9.25" or 9.5" Ride Height 85000 Series	3573265C1		....	....		85931	....	....
Models with IAS Suspension w/ 9.25" or 9.5" Ride Height 89000 Series	3573265C1		....	....		....	89458	....
Models with International Air Suspension 85000 Series	1690035C1 501553C91 1675455C1		....	....		85003	....	....
Models with International Air Suspension 89000 Series	1690035C1 501553C91 1675455C1		....	....		....	89411	....
Models with Neway ARD-125/244 Air Suspension 83000 Series	790335C91		....	....		83209	....	....
Models with Neway ARD-125/244 Air Suspension 89000 Series	790335C91		....	....		....	89414	....
Models with O.E.M Number 85000 Series	3571713C1		85333	....		....	....	....
Set Back Axle Models with 16,000 lb to 18,000 lb Suspension 85000 Series	1664149C1		85029	....		....	....	....
Set Forward Axle Models with 16,000 lb to 18,000 lb Suspension 85000 Series	507202C1		85030	....		....	....	....
Set Forward Axle Models with 16,000 lb to 18,000 lb Suspension 89000 Series	507202C1		....	89440		....	....	....

## INTERNATIONAL

### SERIES 9600 & 9700 PREMIUM CABOVER TRACTOR

9600, 9700 Models 85000 Series	507202C1		85030	....		....	....	....
9600, 9700 Models 89000 Series	507202C1		....	89440		....	....	....
9600, 9700 Models Except Low Profile 85000 Series	1664788C2 2015556C1		85316	....		....	....	....
9600, 9700 Models Except Low Profile 89000 Series	1664788C2 2015556C1		....	89426		....	....	....
9600, 9700 Models for Low Profile 83000 Series	503610C2		83207	....		....	....	....
9600, 9700 Models for Low Profile 89000 Series	503610C2		....	89407		....	....	....
9600, 9700 Models with 16000 - 18000 lb Suspension 85000 Series	1667520C1		85058	....		....	....	....
9600, 9700 Models with 16000 - 18000 lb Suspension 89000 Series	1667520C1		....	89431		....	....	....
9600, 9700 Models with Hendrickson HA-460 Air Suspension with 55" or 60" axle spacing and 40000 or 46000 lb capacity 85000 Series	AMS600102		....	....		85005	....	....
9600, 9700 Models with Hendrickson HA-460 Air Suspension with 55" or 60" axle spacing and 40000 or 46000 lb capacity 89000 Series	AMS600102		....	....		....	89430	....
9600, 9700 Models with International STL Spring Suspension 83000 Series	503550C1		....	....		83207	....	....
9600, 9700 Models with International STL Spring Suspension 89000 Series	503550C1		....	....		....	89407	....
9600, 9700 Models with Neway ARD-125/244 Air Suspension 83000 Series	790335C91		....	....		83209	....	....
9600, 9700 Models with Neway ARD-125/244 Air Suspension 89000 Series	790335C91		....	....		....	89414	....
9600, 9700 Models with Neway ARD-234 Air Suspension 83000 Series	537524C91		....	....		83123	....	....
9600, 9700 Models with Neway ARD-234 Air Suspension 89000 Series	537524C91		....	....		....	89405	....
Models with International Air Suspension 85000 Series	1690035C1 2018987C1 2018987C2 501553C91 1675455C1		....	....		85003	....	....

# APPLICATION GUIDE

Year	Fitment Notes	OEM#					
			Fleetline	GasSLX	Fleetline	GasSLX	Cab Shock/ Specialty Shock

## INTERNATIONAL

### SERIES 9600 & 9700 PREMIUM CABOVER TRACTOR (cont)

	Models with International Air Suspension 89000 Series	21690035C1 2018987C1 2018987C2 501553C91 1675455C1	....	....	....	89411	....
--	---	--	------	------	------	-------	------

## INTERNATIONAL

### SERIES 9800 - PREMIUM CABOVER TRACTOR

	6 X 4 Models with International Air Suspension 85000 Series	2018987C1 2018987C2	....	....	85003	....	....
	6 X 4 Models with International Air Suspension 89000 Series	2018987C1 2018987C2	....	....	....	89411	....
	6 X 4 Models with Neway AD-246-10 Air Suspension and 60" Axle Spacing Heavy Duty 85000 Series	2029200C91 AMS600172	....	....	85030	....	....
	6 X 4 Models with Neway AD-246-10 Air Suspension and 60" Axle Spacing Heavy Duty 89000 Series	2029200C91 AMS600172	....	....	....	89440	....
	6 X 4 Models with Neway AD-246-10 Air Suspension and 60" Axle Spacing Standard 83000 Series	2029200C91 AMS600172	....	....	83126	....	....
	6 X 4 Models with Neway AD-246-10 Air Suspension and 60" Axle Spacing Standard 89000 Series	2029200C91 AMS600172	....	....	....	89430	....
	9800 Models - with Hendrickson HA-460 Air Suspension with 55" & 60" axle spacing and 40000 & 46000 lb capacity 85000 Series	AMS600102	....	....	85005	....	....
	9800 Models - with Hendrickson HA-460 Air Suspension with 55" & 60" axle spacing and 40000 & 46000 lb capacity 89000 Series	AMS600102	....	....	....	89430	....
	9800 Models - with Hendrickson HAS-402-60 Air Suspension 85000 Series	AMS650420	....	....	85013	....	....
	9800 Models - with Hendrickson HAS-402-60 Air Suspension 89000 Series	AMS650420	....	....	....	89414	....
	9800 Models - with Set Back axle 85000 Series	2015556C1	 O	85316	....	....	....
	9800 Models - with Set Back axle 89000 Series	2015556C1	 O	....	89426	....	....
	9800 Models - with Set Forward axle 83000 Series	503610C2	O O	83207	....	....	....
	9800 Models - with Set Forward axle 89000 Series	503610C2	O O	....	89407	....	....

### SERIES 9900, 9900I, 9900IX LONG HOOD CONV. TRUCK

	6 X 4 Models with International Air Suspension Exc. Lo-Profile 85000 Series	2018987C1 2018987C2	....	....	85003	....	....
	6 X 4 Models with International Air Suspension Exc. Lo-Profile 89000 Series	2018987C1 2018987C2	....	....	....	89411	....
	6 X 4 Models with International Air Suspension For Lo-Profile 83000 Series	1660846C91 1660846C92	....	....	83101	....	....
	6 X 4 Models with Neway AD-246-10 Air Suspension and 60" Axle Spacing Heavy Duty 85000 Series	2029200C91 AMS600172	....	....	85030	....	....
	6 X 4 Models with Neway AD-246-10 Air Suspension and 60" Axle Spacing Heavy Duty 89000 Series	2029200C91 AMS600172	....	....	....	89440	....
	6 X 4 Models with Neway AD-246-10 Air Suspension and 60" Axle Spacing Standard 83000 Series	2029200C91 AMS600172	....	....	83126	....	....
	6 X 4 Models with Neway AD-246-10 Air Suspension and 60" Axle Spacing Standard 89000 Series	2029200C91 AMS600172	....	....	....	89430	....
	Day Cab Models with 12,000 lb Front Axles To 2011 85000 Series	3581106C2 3581106C1 3581106C3	 O	85924	....	....	....
	Day Cab Models with 12,000 lb Front Axles To 2011 89000 Series	3581106C2 3581106C1 3581106C3	 O	....	89457	....	....
	Models with 10,800 lb - 14,600 lb Suspension 83000 Series	503610C2	O O	83207	....	....	....
	Models with 10,800 lb - 14,600 lb Suspension 89000 Series	503610C2	O O	....	89407	....	....
	Models with 12,000 - 14,000 lb Suspension 85000 Series	1664788C2 2015556C1 2032533C1	 O	85316	....	....	....
	Models with 12,000 - 14,000 lb Suspension 89000 Series	1664788C2 2015556C1 2032533C1	 O	....	89426	....	....
	Models with 12,000 to 14,600 lb Taperleaf Front Spring Suspension 85000 Series	4213758C1 4212942C1 3983162C2 3983162C1	 O	85639	....	....	....
	Models with 16,000 - 18,000 lb Suspension 85000 Series	1667520C1	O O	85058	....	....	....
	Models with 16,000 - 18,000 lb Suspension 89000 Series	1667520C1	O O	....	89431	....	....



# APPLICATION GUIDE

Year	Fitment Notes	OEM#					
			Fleetline	GasSLX	Fleetline	GasSLX	Cab Shock Specialty Shock

## INTERNATIONAL

### TRANSTAR - 8500, 8600 SERIES (cont)

10-18	Models with 40,000 lb Rear Air Suspension 85000 Series	3549099C1 3549099C3 3549099C2	...	...	OO	85923	...	...
	Models with 40,000 lb Rear Air Suspension 89000 Series	3549099C1 3549099C3 3549099C2	...	...	OO	...	89458	...
10-15	Models with 10,000 to 14,000 lb Front axle 85000 Series	3588209C1 3588209C2 3533357C1 3533357C2	OO	85957	...	...	...	...

## INTERNATIONAL

### TRANSTAR - CONVENTIONAL

	4170, F-4170, 4200, F-4200, 4300 & F-4300 Models 85000 Series	477132C1 426744R91 426744R92 453576C91 453576C92	OO	85303	...	...	...	...	
	4170, F-4170, 4200, F-4200, 4300 & F-4300 Models 89000 Series	477132C1 426744R91 426744R92 453576C91 453576C92	OO	...	89422	...	...	...	
	4170, F-4170, 4200, F-4200, 4300 & F-4300 with Air Ride Suspension 85000 Series	350425C1 462557C91	OO	...	...	OO	85300	...	...
	4170, F-4170, 4200, F-4200, 4300 & F-4300 with Air Ride Suspension 89000 Series	350425C1 462557C91	OO	...	...	OO	...	89419	...
	D-400, DF-400, DC-400, DCF-400 & DCF-400M - Exc. Axle Code 02136 85000 Series	426744R91 426744R92 453576C91	OO	85303	...	OO	...	...	...
	D-400, DF-400, DC-400, DCF-400 & DCF-400M - Exc. Axle Code 02136 89000 Series	426744R91 426744R92 453576C91	OO	...	89422	OO	...	...	...
	D-400, DF-400, DC-400, DCF-400 & DCF-400M with Axle Code 02136 85000 Series	293009C91 453577C91	OO	85308	...	OO	...	...	...
	D-400, DF-400, DC-400, DCF-400 & DCF-400M with Axle Code 02136 89000 Series	293009C91 453577C91	OO	...	89422	OO	...	...	...

### UNISTAR

	Additional O.E.M. Interchanges 83000 Series	56101-Z5008		83114	...	...	...	...
	CO7044A 85000 Series	426744R91 426744R92 453576C91	OO	85303	...	OO	...	...
	CO7044A 89000 Series	426744R91 426744R92 453576C91	OO	...	89422	OO	...	...

### VARIOUS

	Additional O.E.M. Interchanges 85000 Series	70334 AMS650107		85316	...	...	...	...	
		3541456C1	OO	85929	...	OO	...	...	
		AMS650406	OO	...	...	OO	85024	...	...
		AMS650400	OO	...	...	OO	85033	...	...
		AMS650404	OO	...	...	OO	85310	...	...
		AMS650402 453528C91 453527C91	OO	...	...	OO	85311	...	...
		AMS650408	OO	...	...	OO	85319	...	...
		3544768C1 3544768C2 3549100C1	OO	...	...	OO	85656	...	...
		3596107C1 3596107C4 3596107C2 3596107C3	OO	...	...	OO	85927	...	...
		Additional O.E.M. Interchanges 89000 Series	70334 AMS650107		...	89426	OO	...	...
			AMS650404	OO	...	...	OO	89423	...
			AMS650402 453528C91 453527C91	OO	...	...	OO	89424	...







# APPLICATION GUIDE

Year	Fitment Notes	OEM#					
			Fleetline	GasSLX	Fleetline	GasSLX	Cab Shock/ Specialty Shock

## INTERNATIONAL

### WORKSTAR 7300 (cont)

15-20	Models with Hendrickson HAS - 230 or 460 Rear Air Suspension	60675-003 H60675-003 3514952C1 60675-003L 57905-001	....	....	O	85976	....	....
-------	--	---	------	------	---	-------	------	------

## INTERNATIONAL

### WORKSTAR 7400

15-20	Models trucks with day cab or extended cabs with Link Cabmate Model IDC7345	1201-9008 2509223C91	....	....	O	....	....	83054	
	Models with 11,000 lb to 14,000 lb Front axle	6127714C1	O	85928	....	....	....	....	
	Models with 12,000 lb Front axle	3576464C2 3533357C1 3576464C1 3533357C2 3533357C3	O	85957	....	....	....	....	
	Models with 16,000 to 20,000 lb Front	6127704C1	O	85670	....	....	....	....	
	Models with Hendrickson HAS - 230 or 460 Rear Air Suspension	60675-003 H60675-003 3514952C1 60675-003L 57905-001	O	....	....	O	85976	....	....
	Models with O.E.M. Number	3885832C2 3885832C1	O	83135	....	....	....	....	

### WORKSTAR 7600

15-22	Models with 11,000 lb to 14,000 lb Front axle	6127714C1	O	85928	....	....	....	....
08-22	Models with Hendrickson HN - 522 Rear Suspension	3515265C1 3515265C2 60680-003L 60680-003	O	....	....	O	83112	....
15-20	Models with 16,000 to 20,000 lb Front	6127704C1	O	85670	....	....	....	....
	Models with Hendrickson HAS - 230 or 460 Rear Air Suspension	60675-003 H60675-003 3514952C1 60675-003L 57905-001	O	....	....	O	85976	....
08-20	Models with 12,000 lb Front axle	3576464C2 3533357C1 3576464C1 3533357C2 3533357C3	O	85957	....	....	....	....

### WORKSTAR 7700

08-12	Models with Hendrickson HAS - 230 or 460 Rear Air Suspension	60675-003 H60675-003 3514952C1 60675-003L 57905-001	....	....	O	85976	....	....
-------	--	---	------	------	---	-------	------	------

## ISUZU

## ISUZU

### ADDITIONAL APPLICATIONS

85	KS22 Models (All) 83000 Series	8-97083-027-0	O	83515	....	....	....	....
	KS22 Models (All) 85000 Series	9-51630-666-2 9-51630-666-0	O	....	....	O	85012	....
	KS22 Models (All) 89000 Series	9-51630-666-2 9-51630-666-0	O	....	....	O	....	89413



### ALL MODELS WITH

	Models with O.E.M. Number 83000 Series	8-97253-623-0 8-97253-621-0 8-97253-616-0 898098-1270	O	83515	....	....	....	....
--	--	--	---	-------	------	------	------	------

### FSR

00-02	Models with 15000, 19000, 21000 lb Multileaf Springs	8-22064232-0	....	....	O	85071	....	....
	Models with 19000, 21000, 23000 lb Taperleaf Springs (EXC Low Profile Veh.)	8-22064233-0	....	....	O	83136	....	....
	Models with FL1 Tilt Cab with 8100 lb Axle (Including Low Profile)	8-22064804-0 8-22064805-0	O	83136	....	....	....	....

# APPLICATION GUIDE

Year	Fitment Notes	OEM#					
			Fleetline	GasSLX	Fleetline	GasSLX	Cab Shock Specialty Shock

## ISUZU

## ISUZU

### FVR

	Models with Hendrickson HAS suspension 83000 Series	12474915		....	....	83122	....	....
	Models with Hendrickson HAS suspension 89000 Series	12474915		....	....	....	89406	....
00-11	Models with Hendrickson HAS suspension	8-97517-966-1 60670-005 60670-005L 8-97517-966-0		....	....	83137	....	....
97-09	Models with 19000, 21000, 23000 lb Taperleaf Springs (EXC Low Profile Veh.)	8-22064233-0		....	....	83136	....	....
	Models with O.E.M. Number	88982682 15887728 8-22064-806-0 8-22064-807-0 19152843		83136	....	....	....	....
94-09	Models with 15000, 19000, 21000 lb Multileaf Springs	8-22064232-0 88982686		....	....	85071	....	....
94-96	FVR Short & Middle Chassis	1-51630-160-0		83162	....	....	....	....
	Models with O.E.M. Number	1-51630-167-0		....	....	83613	....	....
90-92	Models with 15000, 19000, 21000 lb Multileaf Springs	8-22064232-0 88982686		....	....	85071	....	....
88-92	FVR Short & Middle Chassis	1-51630-160-0		83162	....	....	....	....
	Models with O.E.M. Number	1-51630-167-0		....	....	83613	....	....

## ITASCA

## ITASCA

### CLASS A MOTORHOMES

	Models with Workhorse UFO Chassis with Hendrickson Softek Front Suspension 83000 Series	66153-002 F4-BE5-C832-MO		83124	....	....	....	....
	Models with Workhorse UFO Chassis with Hendrickson Softek Front Suspension 89000 Series	66153-002 F4-BE5-C832-MO		....	89407	....	....	....
99-15	SunCruiser Series MotorHomes with Ford F53 Chassis with 16,000 lb GVW to 22,000 lb GVW 83000 Series	ASH-1229 ASH-1228 9U94-18045-AA ASH-1205 AT-620 ASH-1022 1C34-18045-AA ASH-294 9U9Z-18124-A ASH-25822 ASH-25823 1C34-18045-JA AT-766		83209	....	....	....	....
		ASH-1206 9U94-18080-AA AT-621 ASH-25824 9U9Z-18125-A ASH-1023 ASH-1230 ASH-137		....	....	83122	....	....
	SunCruiser Series MotorHomes with Ford F53 Chassis with 16,000 lb GVW to 22,000 lb GVW 89000 Series	ASH-1229 ASH-1228 9U94-18045-AA ASH-1205 AT-620 ASH-1022 1C34-18045-AA ASH-294 9U9Z-18124-A ASH-25822 ASH-25823 1C34-18045-JA AT-766		....	89414	....	....	....
	ASH-1206 9U94-18080-AA AT-621 ASH-25824 9U9Z-18125-A ASH-1023 ASH-1230 ASH-137		....	....	....	89406	....	....
05-11	SunCruiser Series MotorHomes with W20 , W22 , & W24 Workhorse Chassis 85000 Series	24-186629		85125	....	....	....	....
04-11	Sunova Models with W20 , W22 , & W24 WorkHorse MotorHome Chassis 85000 Series	W0005663 F4-BE5-F325-HO 24-153256		....	....	85124	....	....

# APPLICATION GUIDE

Year	Fitment Notes	OEM#					
			Fleetline	GasSLX	Fleetline	GasSLX	Cab Shock Specialty Shock

## ITASCA

## ITASCA

### CLASS A MOTORHOMES (cont)

98-11	Sunova Models with W20 , W22, & W24 WorkHorse MotorHome Chassis 85000 Series	24-153249 W0005662 W0006254 24153249 F4-BE5-A832-MO F4-BE5-F324-HO	OO	85125	....	....	....	....	....
04-06	Horizon Series MotorHomes with Freightliner XC Chassis ADL200 Suspension w/ 20K Rear 85000 Series	16-16873-000	OO	....	....	OO	85029	....	....
	Horizon Series MotorHomes with Freightliner XC Chassis AS120 Front Suspension 83000 Series	16-16874-000 16-16737-000 141700131810	OO	83160	....	OO	....	....	....
	Horizon Series MotorHomes with Freightliner XC Chassis Rear Shock with O.E.M. Number 85000 Series	141700131809 16-16736-000	OO	....	....	OO	85029	....	....
	Horizon Series MotorHomes with Freightliner XC Chassis ZF - IFS Front Suspension with 23,000 lb GVW or Greater 85000 Series	16-18103-000 481700000493	IT	85900	....	OO	....	....	....
02-06	Meridian Series MotorHomes with Freightliner XC Chassis ADL200 Suspension w/ 20K Rear 85000 Series	16-16873-000	OO	....	....	OO	85029	....	....
	Meridian Series MotorHomes with Freightliner XC Chassis AS120 Front Suspension 83000 Series	16-16874-000 16-16737-000 141700131810	OO	83160	....	OO	....	....	....
	Meridian Series MotorHomes with Freightliner XC Chassis Rear Shock with O.E.M. Number 85000 Series	141700131809 16-16736-000	OO	....	....	OO	85029	....	....
	Meridian Series MotorHomes with Freightliner XC Chassis ZF - IFS Front Suspension with 23,000 lb GVW or Greater 85000 Series	16-18103-000 481700000493	IT	85900	....	OO	....	....	....
06	Ellipse Series MotorHomes with Freightliner XC Chassis ADL200 Suspension w/ 20K Rear 85000 Series	16-16873-000	OO	....	....	OO	85029	....	....
	Ellipse Series MotorHomes with Freightliner XC Chassis AS120 Front Suspension 83000 Series	16-16874-000 16-16737-000 141700131810	OO	83160	....	OO	....	....	....
	Ellipse Series MotorHomes with Freightliner XC Chassis Rear Shock with O.E.M. Number 85000 Series	141700131809 16-16736-000	OO	....	....	OO	85029	....	....
	Ellipse Series MotorHomes with Freightliner XC Chassis ZF - IFS Front Suspension with 23,000 lb GVW or Greater 85000 Series	16-18103-000 481700000493	IT	85900	....	OO	....	....	....
03-04	SunCruiser Series MotorHomes with W20 , W22, & W24 Workhorse Chassis 85000 Series	24-153249 F4-BE5-B492-HO W0005662 W0006254 24-186629 F4-BE5-A832-MO F4-BE5-F324-HO	OO	85125	....	OO	....	....	....
98-02	SunCruiser Series MotorHomes with W20 , W22, & W24 Workhorse Chassis 85000 Series	24-186629	OO	85125	....	OO	....	....	....

## JAYCO

## JAYCO

15-20	Alante Series MotorHomes with Ford F53 Chassis with 16,000 lb GVW to 22,000 lb GVW 89000 Series	ASH-1229 ASH-25822 ASH-25823	OO	....	89414	....	....	....	....
		ASH-25824	OO	....	....	OO	....	89406	....
14-20	Precept Series MotorHomes with Ford F53 Chassis with 16,000 lb GVW to 22,000 lb GVW 89000 Series	ASH-1229 ASH-25822 ASH-25823	OO	....	89414	....	....	....	....
		ASH-25824	OO	....	....	OO	....	89406	....

## JIFFLOX

## JIFFLOX

### VARIOUS

	Truck Dolly 85000 Series	CP-5222	OO	85315	....	....	....	....	....
--	--------------------------	---------	----	-------	------	------	------	------	------

## KENWORTH



## KENWORTH

### ADDITIONAL APPLICATIONS

	60" Sleeper with Link Cab Suspension 83000 Series	1202-0043	OO	....	....	OO	....	....	83025
	Conventional Day Cab with O.E.M. Number 83000 Series	R71-6005	OO	....	....	OO	....	....	83042
	Conventional Tractors with A-Model cabs & Link Cabmate Model KWA900 83000 Series	1201-0012 1202-0012	OO	....	....	OO	....	....	83023
	Models with Link Cab Suspension 83000 Series	1202K065	OO	....	....	OO	....	....	83002
		1202-0042	OO	....	....	OO	....	....	83025
		1202-0043	OO	....	....	OO	....	....	83025
86-21	Kenworth Sleepers with Link Cabmate KWS60-A Air Suspension and round cornered doors. 83000 Series	1201-1044	OO	....	....	OO	....	....	83025



# APPLICATION GUIDE

Year	Fitment Notes	OEM#					
			Fleetline	GasSLX	Fleetline	GasSLX	Cab Shock Specialty Shock

## KENWORTH

## KENWORTH

### COE MODELS

	90" and 112" E Models with Link Cabmate KWE90112-B Air Suspension 83000 Series	R71-1005 1202K064	....	....	...	....	83024
	Models with Link Cabmate KW1102-B Air Suspension (Does not fit Non-Sleeper cabs) 83000 Series	1202-0032	....	....	...	....	83016
	Models with Link Cabmate KWE90112-A Air Suspension 83000 Series	1202-0032	....	....	...	....	83016

### ICON 900

	Models with Link Cab Suspension 83000 Series	T71-1002	....	....	...	....	83002
16-17	Models with 10,000 lb to 14,600 lb Taperleaf Springs and Set Back Front Axles 85000 Series	B71-6019	85989	....	....	....	....
	Models with Air Glide 380 (AG380) Rear Air Suspension 85000 Series	C71-1016 C71-6015	....	....	85067	....	....
	Models with Air Glide 380 (AG380) Rear Air Suspension 89000 Series	C71-1016 C71-6015	....	....	....	89451	....
	Models with Air Glide 400 (AG400) Rear Air Suspension 85000 Series	C71-1014	....	....	85936	....	....
	Models with Air Glide 400 (AG400) Rear Air Suspension 89000 Series	C71-1014	....	....	....	89456	....
	Models with Air Glide 460 (AG460) Rear Air Suspension 85000 Series	C71-1015 C71-1015 PLUS	....	....	85937	....	....
	Models with Taper Leaf Springs on Front Axle 85000 Series	B71-1002	85001	....	....	....	....
	Models with Taper Leaf Springs on Front Axle 89000 Series	B71-1002	....	89410	....	....	....
16	Models with 86" Sleepers with O.E.M. Number 83000 Series	T71-1003	....	....	....	....	83056

### K100, K100E, K125

	All with Air Glide 100 Suspension with 8 air bags, 4 units required 85000 Series	K374-29 K374-32	....	....	85310	....	....
	All with Air Glide 100 Suspension with 8 air bags, 4 units required 89000 Series	K374-29 K374-32	....	....	....	89423	....
	All with Air Glide 200 with 40,000 lb Suspension with 8 air bags, 4 units required 85000 Series	665903 70701 665944	....	....	85900	....	....
	All with Air Glide 200 with 46,000 lb Suspension with 8 air bags, 4 units required 85000 Series	665945 665906	....	....	85902	....	....
	Models with Dual Steering Front Axle and Torsion Bar Bogey Rear Suspension 85000 Series	K374-28 K374-4	....	....	85314	....	....
	Models with Dual Steering Front Axle and Torsion Bar Bogey Rear Suspension 89000 Series	K374-28 K374-4	....	....	....	89425	....
	Models with Multiple Leaf Springs on Front Axle 83000 Series	B71-1003 K374-33 K374-3	83312	....	....	....	....
	Models with Multiple Leaf Springs on Front Axle 89000 Series	B71-1003 K374-33 K374-3	....	89409	....	....	....
	Models with Set Back Front Axle 85000 Series	K374-13-1 K374-13	85740	....	....	....	....

### K100E

05-06	Models with Taper Leaf Springs on Front Axle	B71-1002 K374-16 K374-27 K374-26	85001	89410	....	....	....
85-03	Models with Taper Leaf Springs on Front Axle	B71-1002 K374-16 K374-27 K374-26	85001	89410	....	....	....

### K300

93-05	All with Air Glide 100 Suspension with 8 air bags, 4 units required	K374-29 K374-32	....	....	85310	89423	....
	All with Air Glide 200 with 40,000 lb Suspension with 8 air bags, 4 units required	665903 70701 665944	....	....	85900	....	....
	All with Air Glide 200 with 46,000 lb Suspension with 8 air bags, 4 units required	665945 665906	....	....	85902	....	....
	K300 COE Medium Duty	665565	85007	....	....	....	....
	Models with 12,000 lb Taper Leaf Front Springs (5/8" Top Mounting bolt)	665617 B71-1000	85031	....	....	....	....
	Models with Hendrickson Rear Air Suspension	47902-19	....	....	83123	89405	....

# APPLICATION GUIDE

Year	Fitment Notes	OEM#					
			Fleetline	GasSLX	Fleetline	GasSLX	Cab Shock\ Specialty Shock

## KENWORTH

## KENWORTH

### K300 (cont)

93-05	Models with Multiple Leaf Springs on Front Axle (3/4" Mounting bolts)	B71-1003 K374-33 K374-3	OIO	83312	89409			
	Models with Reyco 102 or 79KB Suspension (Drive Axle)	19495-01 16725-01		....	....	OIO	83126	89430
	Models with Reyco 1209 or 1212 Suspension (Steer Axle)	19495-01	OIO	83126	89430		....	....
	Models with Taper Leaf Springs on Front Axle (1" Mounting bolts)	B71-1002 K374-16 K374-27 K374-26	OIO	85001	89410		....	....
	Models with Woodhead Shock (Stamping Number ACHB 966)	ACHB966		....	....	I	83136	....

### K370

13-24	Models with 10,000 lb to 12,000 lb Front Axle	1707378PAC BFRG 072	II	85182	....			
	Models with Hendrickson HAS - 210L or HAS - 230L Rear Air Suspension	60670-008 60670-008L		....	....	OIO	83123	89405
	Models with Reyco 102 or 79KB Suspension (Drive Axle)	19495-01 16725-01		....	....	OIO	83126	89430

### T280

21-24	Models with Hendrickson HAS - 210L or HAS - 230L Rear Air Suspension	60670-008 60670-008L		....	....	OIO	83123	89405
	Models with 10,000 lb to 12,000 lb Mono-leaf front springs	B71-6019	OIO	85989	....		....	....

### T300

	All with Air Glide 100 Suspension with 8 air bags, 4 units required 85000 Series	K374-29 K374-32		....	....	II	85310	
	All with Air Glide 100 Suspension with 8 air bags, 4 units required 89000 Series	K374-29 K374-32		....	....	II	....	89423
	All with Air Glide 200 with 40,000 lb Suspension with 8 air bags, 4 units required 85000 Series	665903 70701 665944		....	....	II	85900	....
	Models with Hendrickson Rear Air Suspension 83000 Series	60670-004		....	....	OIO	83123	....
	Models with Hendrickson Rear Air Suspension 89000 Series	60670-004		....	....	OIO	....	89405
	Models with Multiple Leaf Springs on Front Axle (3/4" Mounting bolts) 83000 Series	B71-1003 K374-33 K374-3	OIO	83312	....		....	....
	Models with Multiple Leaf Springs on Front Axle (3/4" Mounting bolts) 89000 Series	B71-1003 K374-33 K374-3	OIO	....	89409		....	....
	Models with Reyco 102 or 79KB Suspension (Drive Axle) To 2022 83000 Series	19495-01 16725-01		....	....	OIO	83126	....
	Models with Reyco 102 or 79KB Suspension (Drive Axle) To 2022 89000 Series	19495-01 16725-01		....	....	OIO	....	89430
	Models with Reyco 1209 or 1212 Suspension (Steer Axle) To 2022 83000 Series	19495-01	OIO	83126	....		....	....
	Models with Reyco 1209 or 1212 Suspension (Steer Axle) To 2022 89000 Series	19495-01	OIO	....	89430		....	....
	Models with Taper Leaf Springs on Front Axle (1" Mounting bolts) 85000 Series	B71-1002 K374-16 K374-27 K374-26	OIO	85001	....		....	....
	Models with Taper Leaf Springs on Front Axle (1" Mounting bolts) 89000 Series	B71-1002 K374-16 K374-27 K374-26	OIO	....	89410		....	....
Models with Woodhead Shock (Stamping Number ACHB 966) 83000 Series	ACHB966		....	....	I	83136	....	
01-08	All with Air Glide 200 with 46,000 lb Suspension with 8 air bags, 4 units required	665945 665906		....	....	II	85902	
	Models with 12,000 lb Taper Leaf Front Springs (5/8" Top Mounting bolt)	665617 B71-1000	OIO	85031	....		....	....
	Models with Hendrickson HAS - 210L or HAS - 230L Rear Air Suspension	60670-008 60670-008L		....	....	OIO	83123	89405
	Models with Reyco 102 or 79KB Suspension (Drive Axle)	19495-01 16725-01		....	....	OIO	83126	89430
	Models with Reyco 1209 or 1212 Suspension (Steer Axle)	19495-01		....	....	OIO	83126	89430







# APPLICATION GUIDE

Year	Fitment Notes	OEM#					
			Fleetline	GasSLX	Fleetline	GasSLX	Cab Shock/ Specialty Shock

## KENWORTH

## KENWORTH

### T440 (cont)

12-20	Models with Air Glide 460 (AG460) Rear Air Suspension 85000 Series	671963 C71-1015 C71-1015 PLUS	....	....		85937	....	....
	Models with Hendrickson Primaax 230, 460 and 690 Air Suspension (8-1/2" to 10" Ride Height) 85000 Series	60657-003 60657-003L	....	....		85072	....	....
	Models with Hendrickson Primaax EX 232, 462 and 692 Air Suspension (8-1/2" to 10" Ride Height) 85000 Series	60657-003 60657-003L	....	....		85072	....	....
12-19	Models with Air Glide 400 (AG400) Rear Air Suspension 85000 Series	671962 C71-1014	....	....		85936	....	....
	Models with Air Glide 400 (AG400) Rear Air Suspension 89000 Series	671962 C71-1014	....	....		....	89456	....
12-17	Models with Hendrickson HAS - 230 Rear Air Suspension 83000 Series	60670-005	....	....		83137	....	....
	Models with Hendrickson Primaax EX 262S or 522S Rear Air Suspension (10" Ride Height) 85000 Series	60665-011	....	....		85967	....	....
12-16	Models with Neway AD-123 or AD-246 Models Air Suspension with - Shock stamping 85000 Series	90045099	....	....		85906	....	....
		90045132	....	....		85909	....	....
	Models with Neway AD-123 or AD-246 Models Air Suspension with - Shock stamping 89000 Series	90045099	....	....		....	89407	....

### T450

	Models with Link Cabmate KWB400-A Air Suspension 83000 Series	1202-0012	....	....		....	....	83023
	Models with Link Cabmate KWB689-D and Severe service crossmembers 83000 Series	R71-1004 1202K046	....	....		....	....	83049
95-97	All with Air Glide 200 with 46,000 lb Suspension with 8 air bags, 4 units required	665945 665906	....	....		85902	....	....
93-97	Models with Link Cabmate Air Suspension KWB689-A with rear cab support Kenworth P/N K235-1646	1202-0012	....	....		....	....	83023
	Models with Link Cabmate KWB689-B or KWB689-C Air Suspension	1201-1043 1202-1043	....	....		....	....	83025
	Models with Taper Leaf Springs on Front Axle	B71-1002 K374-16 K374-27 K374-26	OO	85001	89410		....	....
92	Models with Link Cabmate Air Suspension KWB689-A with rear cab support Kenworth P/N K235-1646 83000 Series	1202-0012	....	....		....	....	83023
	Models with Link Cabmate KWB689-B or KWB689-C Air Suspension From 06/92 83000 Series	1202-1043	....	....		....	....	83025
	Models with Link Cabmate KWB689-B or KWB689-C Air Suspension From 5/92 83000 Series	1201-1043	....	....		....	....	83025

### T470

10-21	Models with 12,000 to 20,000 lb Taperleaf Front Suspension 85000 Series	665858 B71-1001	OO	85070	....		....	....	....
	Models with 12,000 to 20,000 lb Taperleaf Front Suspension 89000 Series	665858 B71-1001	OO	....	89459		....	....	....
	Models with Air Glide 400L (AG400L) Rear Air Suspension 85000 Series	C71-1017 C71-1011		....	....		85069	....	....
	Models with Air Glide 400L (AG400L) Rear Air Suspension 89000 Series	C71-1017 C71-1011		....	....		....	89455	....
	Models with Reyco 102 or 79KB Suspension (Drive Axle) 83000 Series	19495-01 16725-01 TK19679		....	....		83126	....	....
	Models with Reyco 102 or 79KB Suspension (Drive Axle) 89000 Series	19495-01 16725-01 TK19679		....	....		....	89430	....
10-20	Models with Neway ADZ Rear Suspension 85000 Series	90045812 471700013186 471700004423 90045605 90045803		....	....		85109	....	....
10-19	Models with Air Glide 380 (AG380) Rear Air Suspension 85000 Series	C71-1016 C71-1002 C71-6015		....	....		85067	....	....
	Models with Air Glide 380 (AG380) Rear Air Suspension 89000 Series	C71-1016 C71-1002 C71-6015		....	....		....	89451	....
	Models with Air Glide 460 (AG460) Rear Air Suspension 85000 Series	671963 C71-1015 C71-1015 PLUS		....	....		85937	....	....
	Models with Hendrickson HMX 400/460 Haulmax with 16.5" Saddle 83000 Series	60680-004L 60680-004		....	....		83143	....	....

# APPLICATION GUIDE

Year	Fitment Notes	OEM#					
			Fleetline	GasSLX	Fleetline	GasSLX	Cab Shock Specialty Shock

## KENWORTH

## KENWORTH

### T470 (cont)

10-19	Models with Hendrickson HMX 400/460 Haulmax with 17.5" & 18.5" Saddle 83000 Series	60680-005L 60680-005	...	...	O	83142	...	...
	Models with Hendrickson Primaax 230, 232, 460, 462, 690 and 692 Air Suspension (8-1/2" to 10" Ride Height) 85000 Series	60657-003 60657-003L	...	...	O	85072	...	...
10-18	Models with Chalmers 40,000 lb Rear Suspension 85000 Series	665174	...	...	O	85060	...	...
10-17	Models with Air Glide 400 (AG400) Rear Air Suspension 85000 Series	671962 C71-1014	...	...	O	85936	...	...
	Models with Air Glide 400 (AG400) Rear Air Suspension 89000 Series	671962 C71-1014	...	...	I	...	89456	...
10-16	Models with Air Glide 230 (AG230) Rear Air Suspension 85000 Series	671656 C71-1013	...	...	O	85985	...	...
	Models with Hendrickson HAS - 230 Rear Air Suspension 83000 Series	60670-005	...	...	O	83137	...	...
	Models with Neway AD-123 or AD-246 Models Air Suspension with - Shock stamping 85000 Series	90045099	...	...	O	85906	...	...
		90045132	...	...	O	85909	...	...
Models with Neway AD-123 or AD-246 Models Air Suspension with - Shock stamping 89000 Series	90045099	...	...	O	...	89407	...	

### T480

22-24	Models with 10,000 lb to 12,000 lb Mono-leaf front springs	B71-6019	O	O	O	85989	...	...
	Models with 10,000 lb to 14,600 lb Taperleaf Springs	B71-6019	O	O	O	85989	...	...
	Models with 16,000 lb to 20,000 lb Taperleaf Springs and Set Back Front Axles	B71-6020	O	O	O	85989	...	...
	Models with Drum Brakes with 8 1/2" to 10" Ride Height	60665-018L 60665-018	...	...	O	85961	...	...
	Models with Hendrickson HMX 400/460 Haulmax with 16.5" Saddle	60680-004L 60680-004	...	...	O	83143	...	...
	Models with Hendrickson HMX 400/460 Haulmax with 17.5" & 18.5" Saddle	60680-005L 60680-005	...	...	O	83142	...	...

### T600, T600A, T600B, T602

All with Air Glide 100 Suspension with 8 air bags, 4 units required 85000 Series	All with Air Glide 100 Suspension with 8 air bags, 4 units required 89000 Series	K374-29 K374-32	I	I	I	85310	...	...
	All with Air Glide 200 with 40,000 lb Suspension with 8 air bags, 4 units required 85000 Series	K374-29 K374-32	I	I	I	...	89423	...
	All with Air Glide 200 with 46,000 lb Suspension with 8 air bags, 4 units required 85000 Series	665903 70701 665944	...	...	I	85900	...	...
	All with Air Glide 200 with 46,000 lb Suspension with 8 air bags, 4 units required 85000 Series	665945 665906	...	...	I	85902	...	...
	Models with Hendrickson Rear Air Suspension 83000 Series	47902-24	...	...	O	83137	...	...
	Models with Multiple Leaf Springs on Front Axle 83000 Series	B71-1003 K374-33 K374-3	O	O	O	83312	...	...
	Models with Multiple Leaf Springs on Front Axle 89000 Series	B71-1003 K374-33 K374-3	O	O	O	...	89409	...
	Models with Reyco 102 or 79KB Suspension (Drive Axle) 83000 Series	19495-01 16725-01	...	...	O	83126	...	...
	Models with Reyco 102 or 79KB Suspension (Drive Axle) 89000 Series	19495-01 16725-01	...	...	O	...	89430	...
	Models with Reyco 1209 or 1212 Suspension (Steer Axle) To 2007 83000 Series	19495-01	O	O	O	83126	...	...
Models with Reyco 1209 or 1212 Suspension (Steer Axle) To 2007 89000 Series	19495-01	O	O	O	...	89430	...	

### T600, T600B, T602

05-07	Models with 13,000 lb Front Axle 85000 Series	665858 B71-1001	O	O	O	85070	...	...
	Models with 13,000 lb Front Axle 89000 Series	665858 B71-1001	O	O	O	...	89459	...
01-07	Models with Air Glide 400 (AG400) Rear Air Suspension 85000 Series	671962 C71-1014	...	...	O	85936	...	...
	Models with Air Glide 400 (AG400) Rear Air Suspension 89000 Series	671962 C71-1014	...	...	I	...	89456	...

# APPLICATION GUIDE

Year	Fitment Notes	OEM#					
			Fleetline	GasSLX	Fleetline	GasSLX	Cab Shock/ Specialty Shock

## KENWORTH

## KENWORTH

### T600, T600B, T602

01-07	Models with Air Glide 380 (AG380) Rear Air Suspension 85000 Series	C71-1016 C71-1002	....	....	85067	....	....
	Models with Air Glide 380 (AG380) Rear Air Suspension 89000 Series	C71-1016 C71-1002	....	....	....	89451	....

### T600A

	Models with Link Cabmate KWB689-A Air Suspension and rear cab mount Kenworth P/N K235-1436 or K235-1488 83000 Series	1202-0012	....	....	....	....	83023
	Models with Link Cabmate KWB689-B or KWB689-C Air Suspension and rear cab mount Kenworth part # K235-1436 or K235-1488 83000 Series	1201-1043 1202-1043	....	....	....	....	83025
	Models with Link Cabmate KWB689-D and Severe service crossmembers 83000 Series	R71-1004 1202K046	....	....	....	....	83049
05-08	Models with 13,000 lb Front Axle	665858 B71-1001	O	85070	89459	....	....
	Models with Air Glide 460 (AG460) Rear Air Suspension	671963 C71-1015 C71-1015 PLUS 671963-2	O	....	....	85937	....
01-08	Models with Air Glide 380 (AG380) Rear Air Suspension	C71-1016 C71-1002	....	....	....	85067	89451
	Models with Air Glide 400 (AG400) Rear Air Suspension	671962 C71-1014	....	....	....	85936	89456
98-08	Models with Link Cabmate KWB689-D and Severe service crossmembers	25333002 R71-1004 1202K046 1202-1046	....	....	....	....	83049
95-08	All with Air Glide 200 with 46,000 lb Suspension with 8 air bags, 4 units required	665945 665906	....	....	....	85902	....
93-08	Models with Hendrickson HAS - 210L or HAS - 230L Rear Air Suspension	60670-008 47902-19 60670-008L	....	....	....	83123	89405
86-08	Models with Link Cabmate KWMC642 Air Suspension	1202-0054	....	....	....	....	83021
	Models with Taper Leaf Springs on Front Axle	B71-1002 K374-16 K374-27 K374-26	O	85001	89410	....	....

### T660

	Carhauler with O.E.M. Number 89000 Series	K374-36	O	....	89432	....	....
19-20	Models with 86" Sleepers with O.E.M. Number	1202K286 T71-1003 1202-1286	O	....	....	....	83056
07-20	Models with 12,000 or 13,200 lb Front Axle	665858 B71-1001	O	85070	89459	....	....
	Models with Air Glide 230 (AG230) Rear Air Suspension	671656 C71-1013	O	....	....	85985	....
	Models with Air Glide 380 (AG380) Rear Air Suspension	C71-1016 C71-1002 C71-6015	O	....	....	85067	89451
	Models with Air Glide 400L (AG400L) Rear Air Suspension	03-08781 C71-1017 C71-1011	O	....	....	85069	89455
	Models with Air Glide 460 (AG460) Rear Air Suspension	671963 C71-1015 C71-1015 PLUS 671963-2	O	....	....	85937	....
13-18	Models with Air Glide 400 (AG400) Rear Air Suspension	671962 C71-1014	O	....	....	85936	89456
	Models with O.E.M. Number	B71-6012	O	85119	....	....	....
07-17	Models with 86" Sleepers with O.E.M. Number	1202K286 T71-1003 1202-1286	O	....	....	....	83056
07-10	Models with Link Cab Suspension	1202-1065	O	....	....	....	83002

### T680

17-24	Day Cab Models with O.E.M. Number	25523002 1201-8001	O	....	....	....	83908
14-24	Models with 10,000 lb to 14,600 lb Taperleaf Springs and Set Back Front Axles	B71-6019	O	85989	....	....	....
13-24	Models with Air Glide 400 (AG400) Rear Air Suspension	671962 C71-1014	O	....	....	85936	89456

# APPLICATION GUIDE

Year	Fitment Notes	OEM#					
			Fleetline	GasSLX	Fleetline	GasSLX	Cab Shock\ Specialty Shock

## KENWORTH

## KENWORTH

### T680 (cont)

13-24	Models with Air Glide 400L (AG400L) Rear Air Suspension	C71-1017 C71-1011		....	....		85069	89455	....
	Models with Hendrickson HMX 400/460 or 520 Haulmax with 16.5" Saddle	60680-004L 60680-004		....	....		83143	....	....
	Models with Hendrickson Primaax EX 462 Air Suspensions with 8 1/2" to 10" Ride Height	60657-003 60657-003L		....	....		85072	....	....
	Models with O.E.M. Number	B71-6012		85119	....		....	....	....
	Models with Sleepers with O.E.M. Number	25523013 25523024 R71-6009 1201-8002		....	....		....	....	83081
11-24	Models with Air Glide 380 (AG380) Rear Air Suspension	C71-1016 C71-1002 C71-6015		....	....		85067	89451	....
14-23	Models with 16,000 lb to 20,000 lb Taperleaf Springs and Set Back Front Axles	B71-6020		85989	....		....	....	....
11-23	Models with Air Glide 460 (AG460) Rear Air Suspension	671963 C71-1015 C71-1015 PLUS 671963-2		....	....		85937	....	....
	Models with Hendrickson HMX 400/460 or 520 Haulmax with 17.5" & 18.5" Saddle	60680-005L 60680-005		....	....		83142	....	....
	Models with Hendrickson Primaax EX 462 Air Suspensions with 12 1/2" - 14 3/8" - 15 1/2" Ride Height	60665-011		....	....		85967	....	....
	Models with Neway ADZ Rear Suspension	90045812 471700013186 471700004423 90045605 90045803		....	....		85109	....	....
	Models with Watson & Chalin SL Series Steerable Lift Axle (8,000 to 13,500 lb)	11418 11418WAC		....	....		....	....	646177
23	Models with Reyco 102 or 79KB Suspension (Drive Axle)	19495-01 16725-01 TK19679		....	....		83126	....	....
13-22	Models with 21,000 to 23,000 lb Reyco Spring Suspension	19495-01 TK19679		....	....		....	89430	....
	Models with Reyco 102 or 79KB Suspension (Drive Axle)	TK19679		....	....		83126	....	....
		19495-01 16725-01		....	....		83126	89430	....
13-14	Models with 10,000 lb to 13,200 lb Front Axle	B71-6005		85084	89460		....	....	....
11-12	Models with Reyco 102 or 79KB Suspension (Drive Axle)	19495-01 16725-01 TK19679		....	....		83126	....	....

### T700

11-16	Models with 13,000 lb Front Axle	665858 B71-1001		85070	89459		....	....	....
	Models with 86" Sleepers with O.E.M. Number	1202K286 T71-1003 1202-1286		....	....		....	....	83056
	Models with Air Glide 230 (AG230) Rear Air Suspension	671656 C71-1013		....	....		85985	....	....
	Models with Air Glide 380 (AG380) Rear Air Suspension	C71-1016 C71-1002 C71-6015		....	....		85067	89451	....
	Models with Air Glide 400 (AG400) Rear Air Suspension	671962 C71-1014		....	....		85936	89456	....
	Models with Air Glide 400L (AG400L) Rear Air Suspension	03-08781 C71-1017 C71-1011		....	....		85069	89455	....
	Models with Extended Sleeper Cab	R71-1005 1202-1064 1202K064		....	....		....	....	83024

### T800

	Models with Link Cabmate KWB689-A Air Suspension and rear cab mount Kenworth P/N K235-1436 or K235-1488 83000 Series	1202-0012		....	....		....	....	83023
	Models with Link Cabmate KWB689-B or KWB689-C Air Suspension and rear cab mount Kenworth part # K235-1436 or K235-1488 83000 Series	1201-1043 1202-1043		....	....		....	....	83025
	Models with Link Cabmate KWMC642 Air Suspension 83000 Series	1202-0054		....	....		....	....	83021





# APPLICATION GUIDE

Year	Fitment Notes	OEM#					
			Fleetline	GasSLX	Fleetline	GasSLX	Cab Shock\ Specialty Shock

## KENWORTH

## KENWORTH

### T800, T800B, T800B(8X4), T800SH, T800H, T800W (cont)

	Models with Neway Rear Air Suspension 83000 Series	90044089	....	....	O	83124	....	....
	Models with Neway Rear Air Suspension 89000 Series	90044089	....	....	O	....	89407	....
	Models with Torsion Bar Bogey (2 rear axles) and KW Air Ride Suspension (with 4 air bags) 85000 Series	K374-28 K374-4	....	....	O	85314	....	....
	Models with Torsion Bar Bogey (2 rear axles) and KW Air Ride Suspension (with 4 air bags) 89000 Series	K374-28 K374-4	....	....	O	....	89425	....
10-21	Models with Air Glide 400 (AG400) Rear Air Suspension 85000 Series	671962 C71-1014	....	....	O	85936	....	....
	Models with Air Glide 400 (AG400) Rear Air Suspension 89000 Series	671962 C71-1014	....	....	O	....	89456	....

### T800B, T800B(8X4), T800SH, T800H, T800W

07-09	Models with Air Glide 400 (AG400) Rear Air Suspension 85000 Series	671962 C71-1014	....	....	O	85936	....	....
	Models with Air Glide 400 (AG400) Rear Air Suspension 89000 Series	671962 C71-1014	....	....	O	....	89456	....
06-09	Models with Air Glide 230 (AG230) Rear Air Suspension 85000 Series	671656 C71-1013	....	....	O	85985	....	....
01-09	Models with Air Glide 380 (AG380) Rear Air Suspension 85000 Series	C71-1016 C71-1002 C71-6015	....	....	O	85067	....	....
	Models with Air Glide 380 (AG380) Rear Air Suspension 89000 Series	C71-1016 C71-1002 C71-6015	....	....	O	....	89451	....
00-09	Models with Chalmers 40,000 lb Rear Suspension 85000 Series	665174	....	....	O	85060	....	....

### T880

	With Hendrickson Rear Suspension 85000 Series	60675-017	....	....	O	85979	....	....
20-24	Models with Sleepers with O.E.M. Number (Shock only)	25523013 1201-8002	....	....	O	....	....	83081
14-24	Day Cab Models with O.E.M. Number	25523002 1201-8001	....	....	O	....	....	83908
	Models with 16,000 lb to 20,000 lb Taperleaf Springs and Set Back Front Axles	B71-6020	O	85989	....	....	....	....
11-24	Models with Air Glide 380 (AG380) Rear Air Suspension	C71-1016 C71-1002 C71-6015	....	....	O	85067	89451	....
	Models with Air Glide 400 (AG400) Rear Air Suspension	671962 C71-1014	....	....	O	85936	89456	....
	Models with Air Glide 400L (AG400L) Rear Air Suspension	C71-1017	....	....	O	85069	89455	....
	Models with Air Glide 460 (AG460) Rear Air Suspension	C71-1015A 671963 C71-1015 C71-1015 PLUS 671963-2	....	....	O	85937	....	....
	Models with Hendrickson 46,000 lb Primaax Rear Air Suspension	60675-003 60675-003L	....	....	O	85976	....	....
	Models with Hendrickson HMX 400/460 or 520 Haulmax with 16.5" Saddle	60680-004L 60680-004	....	....	O	83143	....	....
	Models with Hendrickson HMX 400/460 or 520 Haulmax with 17.5" & 18.5" Saddle	60680-005L 60680-005	....	....	O	83142	....	....
	Models with Hendrickson Primaax EX 462 Air Suspensions with 8 1/2" to 10" Ride Height	60657-003 60657-003L	....	....	O	85072	....	....
	Models with Neway ADZ Rear Suspension	90045812 471700013186 471700004423 90045605 90045803	....	....	O	85109	....	....
14-23	Models with 10,000 lb to 14,600 lb Taperleaf Springs and Set Back Front Axles	B71-6019	O	85989	....	....	....	....
23	Models with 18,000 lb to 23,000 lb Taperleaf Front Spring Suspension and Set Forward Front Axle.	B71-6011	O	85062	89408	....	....	....
11-22	Models with Reyco 102 or 79KB Suspension (Drive Axle)	19495-01 16725-01	....	....	O	83126	89430	....
11-19	Models with Hendrickson Primaax EX 462 Air Suspensions (Standard with 12 1/2" - 14 3/8" - 15 1/2" Ride Height)	60665-011	....	....	O	85967	....	....
	Models with Watson & Chalin SL Series Steerable Lift Axle (8,000 to 13,500 lb)	11418 11418WAC	....	....	O	....	....	646177
14-18	Sleeper cab Models with Link Cab Suspension	1202-1046	....	....	O	....	....	83049



# APPLICATION GUIDE

Year	Fitment Notes	OEM#					
			Fleetline	GasSLX	Fleetline	GasSLX	Cab Shock/ Specialty Shock

## KENWORTH

## KENWORTH

### T880 (cont)

14-16	Models with O.E.M. Number	B71-6012	O	85119	....				
-------	---------------------------	----------	---	-------	------	--	--	--	--

### T2000

	Models with Multiple Leaf Springs on Front Axle 83000 Series	B71-1003 K374-33 K374-3	O O	83312	....				
	Models with Multiple Leaf Springs on Front Axle 89000 Series	B71-1003 K374-33 K374-3	O O	....	89409				
	Models with PowerPacker Cab Suspension prior to 6/28/98 To 6/98 83000 Series	96027-10545			....	....	O O		83011
06-11	Models with 13,000 lb Front Axle	665858 B71-1001	O O	85070	89459				
05-11	Models with Air Glide 400 (AG400) Rear Air Suspension	671962 C71-1014		....	....	O 	85936	89456	....
	Models with Air Glide 460 (AG460) Rear Air Suspension	671963		....	....	O 	85937	....	....
01-11	Models with Air Glide 380 (AG380) Rear Air Suspension	C71-1016 C71-1002		....	....	O O O	85067	89451	....
98-11	Models with PowerPacker Cab Suspension after 6/28/98	PP2582870		....	....	O O O	....	....	83012
97-11	All with Air Glide 100 Suspension with 8 air bags, 4 units required	K374-29 K374-32		....	....	 	85310	89423	....
	All with Air Glide 200 with 40,000 lb Suspension with 8 air bags, 4 units required	665903 70701 665944		....	....	 	85900	....	....
	All with Air Glide 200 with 46,000 lb Suspension with 8 air bags, 4 units required	665945 665906		....	....	 	85902	....	....
	Models with Link Cabmate KWT2000-A Air Suspension	R71-1005 1202-1064 1202K064		....	....	O O	....	....	83024
	Models with Taper Leaf Springs on Front Axle	B71-1002 K374-16 K374-27 K374-26	O O		85001	89410		....	....

### VARIOUS

	Models with Hendrickson Primaax 260 or 520 Rear Air Suspension (10" Ride Height-Drum Brakes only) 85000 Series	60665-013		....	....	O O	85965	....	....
	Models with Hendrickson Primaax EX 262 or 522 Rear Air Suspension (10" Ride Height) 85000 Series	60665-013		....	....	O O	85965	....	....
	Models with Hendrickson Primaax EX 262S or 522S Rear Air Suspension (10" Ride Height) 85000 Series	60665-011		....	....	O O	85967	....	....

### W900

	Models with Link Cabmate KWB689-A Air Suspension and rear cab mount Kenworth P/N K235-1436 or K235-1488 83000 Series	1202-0012		....	....	O O	....	....	83023
	Models with Link Cabmate KWB689-B or KWB689-C Air Suspension and rear cab mount Kenworth part # K235-1436 or K235-1488 83000 Series	1201-1043 1202-1043		....	....	O O	....	....	83025
	Models with Link Cabmate KWMC642 Air Suspension 83000 Series	1202-0054		....	....	O O	....	....	83021
20-24	Models with Hendrickson 46,000 lb Primaax Rear Air Suspension	60675-003 60675-003L		....	....	O O	85976	....	....
10-24	Models with Neway ADZ Rear Suspension	90045812 471700013186 471700004423 90045605 90045803		....	....	O O	85109	....	....
	Models with Taper Leaf Springs on Front Axle	B71-1002 K374-16 K374-27 K374-26	O O		85001	89410		....	....
08-24	Models with Air Glide 400L (AG400L) Rear Air Suspension	C71-1017 C71-1011		....	....	 	85069	89455	....
06-24	Models with Link Cab Suspension	T71-1002 1202K065		....	....	O O	....	....	83002
05-24	Models with Air Glide 460 (AG460) Rear Air Suspension	671963 C71-1015 C71-1015 PLUS 671963-2		....	....	O 	85937	....	....
04-24	Models with Air Glide 400 (AG400) Rear Air Suspension	671962 C71-1014		....	....	O 	85936	89456	....
	Models with Hendrickson Primaax EX 462 Air Suspensions with 8 1/2" to 10" Ride Height	60657-003 60657-003L		....	....	O O	85072	....	....



# APPLICATION GUIDE

Year	Fitment Notes	OEM#					
			Fleetline	GasSLX	Fleetline	GasSLX	Cab Shock Specialty Shock

## KENWORTH

## KENWORTH

### W900, W900B, W900L, W900S (cont)

10	Models with 46,000 lb Neway Rear Air Suspension 85000 Series	90045132	....	....	85909	....	....
----	--	----------	------	------	-------	------	------

### W900B, W900L, W900S

01-21	Models with Air Glide 380 (AG380) Rear Air Suspension 85000 Series	C71-1016 C71-1002 C71-6015	....	....	85067	....	....
	Models with Air Glide 380 (AG380) Rear Air Suspension 89000 Series	C71-1016 C71-1002 C71-6015	....	....	....	89451	....

### W990

19-24	Day Cab Models with O.E.M. Number	25523002 1201-8001	....	....	....	....	83908
	Models with 14,600 lb Taperleaf Front Spring Suspension	B71-6013	85012	89413	....	....	....
	Models with Air Glide 380 (AG380) Rear Air Suspension	C71-6015	....	....	85067	89451	....
	Models with Air Glide 400 (AG400) Rear Air Suspension	C71-1014	....	....	85936	89456	....
	Models with Air Glide 400L (AG400L) Rear Air Suspension	C71-1017	....	....	85069	89455	....
	Models with Air Glide 460 (AG460) Rear Air Suspension	C71-1015 C71-1015 PLUS 671963-2	....	....	85937	....	....
	Models with Hendrickson 46,000 lb Primaax Rear Air Suspension	60675-003 60675-003L	....	....	85976	....	....
	Models with Hendrickson HMX 400/460 or 520 Haulmax with 16.5" Saddle	60680-004L 60680-004	....	....	83143	....	....
	Models with Hendrickson HMX 400/460 or 520 Haulmax with 17.5" & 18.5" Saddle	60680-005L 60680-005	....	....	83142	....	....
	Models with Hendrickson Primaax 230, 460 and 690 Air Suspension (8-1/2" to 10" Ride Height)	60657-003 60657-003L	....	....	85072	....	....
	Models with Neway ADZ Rear Suspension	90045812 471700013186 471700004423 90045605 90045803	....	....	85109	....	....
	Models with O.E.M. Number	B71-6012	85119	....	....	....	....
Models with Sleepers with O.E.M. Number	25523013 25523024 R71-6009 1201-8002	....	....	....	....	83081	
23	Models with 18,000 lb to 23,000 lb Taperleaf Front Spring Suspension and Set Forward Front Axle.	B71-6011	85062	89408	....	....	....
19-22	Models with Reyco 102 or 79KB Suspension (Drive Axle)	19495-01 16725-01	....	....	83126	89430	....

## KIMBLE MIXER CO.

## KIMBLE MIXER CO.

### REAR DISCHARGE MIXERS

	Rear Discharge Mixers with Self - Steering Axle Shock Specialty Shock	T91-00002-00	....	....	....	....	646155
	w/ Self Steering Axle Shock & w/ O.E.M. Number Specialty Shock	OE10455	85012	89413	85012	89413	646155

## KING OF THE ROAD

## KING OF THE ROAD

### CLASS A MOTORHOMES

04-06	Genesis Series MotorHomes with Freightliner XC Chassis ADL200 Suspension w/ 20K Rear 85000 Series	16-16873-000	....	....	85029	....	....
	Genesis Series MotorHomes with Freightliner XC Chassis AS120 Front Suspension 83000 Series	16-16874-000 16-16737-000 141700131810	83160	....	....	....	....
	Genesis Series MotorHomes with Freightliner XC Chassis Rear Shock with O.E.M. Number 85000 Series	141700131809 16-16736-000	....	....	85029	....	....
	Genesis Series MotorHomes with Freightliner XC Chassis ZF - IFS Front Suspension with 23,000 lb GVW or Greater 85000 Series	16-18103-000 481700000493	85900	....	....	....	....

## KWK-LOC (JIFFLOX)

## KWK-LOC (JIFFLOX)

### VARIOUS

	Truck Dolly 85000 Series	CP-5222 522217	85315	....	....	....	....
--	--------------------------	-------------------	-------	------	------	------	------

# APPLICATION GUIDE

Year	Fitment Notes	OEM#					
			Fleetline	GasSLX	Fleetline	GasSLX	Cab Shock\ Specialty Shock

## LEYLAND TRUCK

## LEYLAND TRUCK

### VARIOUS (cont)

	Models with Air Trac Suspension (38000 or 40000 lb) 85000 Series	1456033				85311		
	Models with Air Trac Suspension (38000 or 40000 lb) 89000 Series	1456033					89424	

## LION

## LION

### LION8

21-22	Models with Hendrickson Comfort Air Suspension (21K Capacity)	60670-030L 60670-030				83166		
	Trucks with Hendrickson Softek Suspension (14,600 lb Capacity)	58913-010L 58913-010	O	O	O	O		

### LIONC

16-23	Buses with Hendrickson Softek Suspension (10,000 lb - 12,600 lb Capacity)	58913-009L 58913-009						
	Models with Hendrickson HTS 210 Suspension	60665-025 60665-025L	O	O	O	O	85036	89405

## LODAL INC.

## LODAL INC.

### VARIOUS

	Refuse Truck 83000 Series	9960257						
	Refuse Truck 89000 Series	9960257	O	O	O	O		89406

## LONDON MIXER

## LONDON MIXER

	Rear Discharge Mixers with Self - Steering Axle Shock Specialty Shock	MB-37737-30						646155
--	---	-------------	--	--	--	--	--	--------

## MACK

## MACK

### ADDITIONAL APPLICATIONS

	B Models 85000 Series	14QK-142				85305				
	CF Fire Chassis 85000 Series	14QK-2102					85304			
	CM 422 Tractor 83000 Series	14QK-390 V10242320	I	O	O	O				
	MB Models 83000 Series	14QK-2100P4	O	O	O	O				
		.....	O	O	O	O	83215			
	MB Models 89000 Series	14QK-2100P4	O	O	O	O		89407		
	Model 75 Bogie Axle 83000 Series	.....					83215			
	Models with Hendrickson AirTek Front Air Suspension 85000 Series	471700131921 14QK-422M 20469002 20485633 20469001 20485632 64838-002	O	O	O	O				
		Models with Hendrickson AirTek Front Air Suspension 89000 Series	471700131921 14QK-422M 20469002 20485633 20469001 20485632 64838-002	O	O	O	O		89454	
			Models with Hendrickson HAS-40LH Air Suspension (O.E. Number 57241-4) 83000 Series	14QK-413M4					83110	
			Models with Inverted Camelback Spring Suspension 83000 Series	14QK-142P1	O	O	O	O		83215
			Models with MAC AL405 Suspension 83000 Series	14QK-413M					83111	
	Models with Meritor AirLink Suspension 85000 Series	14QK-3100 446-51-211					85739			
	Models with Neway Rear Suspension (With O.E.Stamping 90045099) 85000 Series	25633154					85906			
	Models with Neway Rear Suspension (With O.E.Stamping 90045099) 89000 Series	25633154						89407		
06-16	Models with Hendrickson 40,000 lb Primaax, Pimaax EX and FireMaax EX Air Suspension 85000 Series	60657-007					85072			

# APPLICATION GUIDE

Year	Fitment Notes	OEM#					
			Fleetline	GasSLX	Fleetline	GasSLX	Cab Shock Specialty Shock

## MACK

## MACK

### ADDITIONAL APPLICATIONS (cont)

75-79	W Models - Western 83000 Series	.....	O	83207	.....	O	83215	.....	.....
	W Models - Western 89000 Series	.....	O	.....	89407	O	.....	.....	.....

### ANTHEM

21-24	Anthem 64T Models with 12,000 to 12,500 lb Front Axles	23292027	O	85061	89450	O	.....	.....	.....
	Anthem 64T Models with O.E.M. Number	23159762 23159760	O	.....	.....	O	85188	.....	.....
18-24	Day Cab Models with O.E.M. Number	23145372	O	.....	.....	O	.....	.....	83066
	Models with 13,200 to 14,600 lb Front Axles	141700005839 21436096 23292028	O	85061	89450	O	.....	.....	.....
	Models with Hendrickson 38,000lb Rear Air Suspension	20570098	O	.....	.....	O	83147	.....	.....
	Models with Hendrickson HAS 400 or 460 Series Rear Suspension	8083872 60675-001L 60675-001	O	.....	.....	O	85978	.....	.....
	Models with Hendrickson HMX 400/460 Haulmax with 16.5" Saddle	60680-004L 60680-004 H60680-004	O	.....	.....	O	83143	.....	.....
	Models with Hendrickson HMX 400/460 Haulmax with 17.5" & 18.5" Saddle	25626196 14QK-5142 60680-005L 60680-005 H60680-005	O	.....	.....	O	83142	.....	.....
	Sleeper Cab Models with O.E.M. Number	23327756 23030654	O	.....	.....	O	.....	.....	83910
18-23	Models with Hendrickson HN - 522 Rear Suspension	60680-003L 60680-003	O	.....	.....	O	83112	.....	.....
18-20	Anthem 64T Models with 40,000 lb Rear Air Suspensions	22202560 471700009647	O	.....	.....	O	85088	.....	.....

### CH

89-05	CH Models with Hendrickson HA Series Air Suspension	14QK-410M3 25625254	O	.....	.....	O	83125	.....	.....
		14QK-410M2	O	.....	.....	O	83137	.....	.....
	CH600 Models with 12000 lb Taperleaf Spring	14QK-392AM3 14QK-396M 14QK-392AM 25625743 14QK-392BM3 14QK-392BM 14QK-396	O	85005	89430	O	.....	.....	.....
	CH600 Models with AL Suspension	14QK-393M	O	.....	.....	O	85010	.....	.....
	CH600 Models with ALV Hendrickson Suspension	57241-006 57241-006L 14QK-413M7 25625223 14QK-413M6 25622221	O	.....	.....	O	83111	.....	.....
	CH600 Models with HAS400 MACK Air Suspension	14QK-410M 25625234 47902-25	O	.....	.....	O	83125	.....	.....
	CH600 Models with Hendrickson AL-405 Rear Suspension	57241-006 57241-006L 14QK-413M7 25625223	O	.....	.....	O	83111	.....	.....
	CH600 Models with Hendrickson HAS-40LH Air Suspension (O.E. Number 57241-4)	14QK-413M4 57241-4	O	.....	.....	O	83110	.....	.....
	CH600 Models with Hendrickson HN-2 Series Suspension	14QK-415M7 14QK-415M 25624241 60680-003L 60680-003	O	.....	.....	O	83112	.....	.....
	CH600 Models with Hendrickson Rear Air Suspension	14QK-393AM 47902-9	O	.....	.....	O	83123	89405	.....
	CH600 Models with Neway AD Air Suspension Shock w/ extended length of 21.70"	90045099 14QK-414M	O	.....	.....	O	85906	89407	.....
	CH600 Models with Neway AD Air Suspension Shock w/ extended length of 24.30"	14QK-414M2 25624351	O	.....	.....	O	85909	.....	.....
	CH600 Models with ST34 Suspension	25622466 14QK-2133M	O	85001	89410	O	.....	.....	.....

# APPLICATION GUIDE

Year	Fitment Notes	OEM#					
			Fleetline	GasSLX	Fleetline	GasSLX	Cab Shock\ Specialty Shock

## MACK

## MACK

### CH (cont)

89-05	Models with O.E.M. Number	471700000426 14QK-421M	O	85014	....	....	....	....	....	....	
		14QK-2113P6		....	....	....	....	....	....	....	....
		14QK-411M 14QK-411AM 14QK-411 25631922		....	....	....	....	....	....	....	83007
	Models with Sleeper Cab	14QK-391AM2 14QK-391AM		....	....	....	....	....	....	83041	

### CHN

05-07	CHN-613 Models with O.E.M. Number	20874147 14QK-3103M		....	....	....	....	....	....	83050
04-07	CHN-613 Models w/ MACK Air Suspension	SDA471700000431 14QK-3101M 471700000431		....	....	....	....	....	....	....
		CHN-613 Models with 12,000 lb Front Axle	20973993 14QK-3107M	O	85061	89450	....	....	....	....
	CHN-613 Models with 14,600 lb Front Axle	14QK-434M 20998401	O	85014	....	....	....	....	....	....
	CHN-613 Models with Camelback Rear Suspension (SS34 & 38)	25625091		....	....	....	....	....	....	....

### CHU

14-19	Day Cab Models with O.E.M. Number	23145372 21490486 21345869		....	....	....	....	....	....	83066
12-19	Models with O.E.M. Number	22662254 22662259		....	....	....	....	....	....	83901
11-19	CHU-613 Models with 40,000 lb Rear Air Suspensions	22202560 471700009647		....	....	....	....	....	....	85088
08-19	CHU-613 Models with 12,000 lb or 14,600 lb Front Axle	14QK-434M 471700002861 20998401 SDA471700002861 20625775	O	85014	....	....	....	....	....	....
		CHU-613 Models with Camelback Rear Suspension (SS34 & 38)	25625091 14QK-2107P2		....	....	....	....	....	....
	CHU-613 Models with Hendrickson 38,000 lb Rear Air Suspension	60670-006 14QK-424M 20570098 60670-006L		....	....	....	....	....	....	83147
	CHU-613 Models with Hendrickson HAS 400 or 460 Series Rear Suspension	8083872 60675-001L 60675-001		....	....	....	....	....	....	85978
	CHU-613 Models with O.E.M. Number	20874147 14QK-303M 14QK-3103M		....	....	....	....	....	....	83050
	Models with Sleeper Cabs with O.E.M. Number	25625637 14QK-399M3 14QK-399M2 14QK-399M 25625635 25625636		....	....	....	....	....	....	83045
04-07	CHU-613 Models with Hendrickson 38,000 lb Rear Air Suspension 83000 Series	60670-006 14QK-424M 20570098 60670-006L		....	....	....	....	....	....	83147
		CHU-613 Models with Hendrickson HAS 400 or 460 Series Rear Suspension 85000 Series	8083872 60675-001L 60675-001		....	....	....	....	....	....
07	CHU-613 Models with 40,000 lb Rear Air Suspensions 85000 Series	14QK-2136M 20897198		....	....	....	....	....	....	85061
		CHU-613 Models with 40,000 lb Rear Air Suspensions 89000 Series	14QK-2136M 20897198		....	....	....	....	....	....

### CL

91-07	CL600, CL700 Models with ALV Hendrickson Suspension	57241-006 57241-006L 14QK-413M7 25625223 14QK-413M6 25622221		....	....	....	....	....	....	83111
		CL600, CL700 Models with HAS400 MACK Air Suspension	14QK-410M 25625234 47902-25		....	....	....	....	....	....

# APPLICATION GUIDE

Year	Fitment Notes	OEM#					
			Fleetline	GasSLX	Fleetline	GasSLX	Cab Shock Specialty Shock

## MACK

## MACK

### CL (cont)

91-07	CL600, CL700 Models with Hendrickson HA Series Air Suspension	14QK-410M3 25625254	....	....	O	83125	....	....	
		14QK-410M2	....	....	O	83137	....	....	
	CL600, CL700 Models with Hendrickson HN-2 Series Suspension	14QK-415M7 14QK-415M 25624241 60680-003L 60680-003	....	....	O	83112	....	....	
		14QK-393AM 47902-9	....	....	O	83123	89405	....	
	CL600, CL700 Models with Multileaf Spring Suspension	14QK-392BM2 25624862	O	85321	....	....	....	....	
	CL600, CL700 Models with Neway AD Air Suspension Shock w/ extended length of 21.70"	90045099 14QK-414M	O	....	....	O	85906	89407	....
	CL600, CL700 Models with Neway AD Air Suspension Shock w/ extended length of 24.30"	14QK-414M2 25624351	O	....	....	O	85909	....	....
	CL600, CL700 Models with ST34 Suspension	25632145 25622466 25621955 14QK-2133M 14QK-2113	O	85001	89410	....	....	....	
	CL600, CL700 Models with Steering Axle & Taperleaf Spring	14QK-392AM2 14QK-392AM3 14QK-392AM 25625743 14QK-392BM	O	85005	89430	....	....	....	
Models with O.E.M number	14QK-391AM2 14QK-391AM	O	....	....	O	....	....	83041	

### CS, MS - MID - LINER SERIES

86-01	CS Models Mid-Liner with O.E.M Number 83000 Series	4103-5000546892 4103-5000447861 V10234121 V10242320	O	83105	....	....	....	....
-------	--	--	---	-------	------	------	------	------

### CT

05-07	Models with 20,000 lb Front Axles	14QK-3108M 20863239 14QK-427M 25626048 471700000445	O	85080	....	....	....	....
		Models with O.E.M. Number	14QK-3116M	O	83101	....	....	....
		20874147 14QK-3103M	O	....	....	O	....	83050

### CTX

	Models with O.E.M. Number 83000 Series	20874147 14QK-303M 14QK-3103M	O	....	....	O	....	83050
--	--	-------------------------------------	---	------	------	---	------	-------

### CV

01-08	CV-713 Models with 18,000 lb Front Axles	25625151 14QK-366	O	85036	89405	....	....	....
		CV-713 Models with Hendrickson HN-2 Models Suspension	14QK-415M7 14QK-415M 25624241 60680-003L 60680-003	O	....	....	O	83112
	Models with Hendrickson HMX 400/460 Haulmax with 16.5" Saddle	60680-004L 60680-004 H60680-004	O	....	....	O	83143	....
	Models with Hendrickson HMX 400/460 Haulmax with 17.5" & 18.5" Saddle	25626196 14QK-5142 60680-005L 60680-005 H60680-005	O	....	....	O	83142	....
	Models with O.E.M number	14QK-391BM	O	....	....	O	....	83041

### CX

00-05	Models with Sleeper Cabs with O.E.M. Number	25625637 14QK-399M3 14QK-399M2 14QK-399M 25625635 25625636	O	....	....	O	....	83045
-------	---	---	---	------	------	---	------	-------



# APPLICATION GUIDE

Year	Fitment Notes	OEM#					
			Fleetline	GasSLX	Fleetline	GasSLX	Cab Shock\ Specialty Shock

## MACK

## MACK

### CX (cont)

98-05	CX Vision Models w/ Hendrickson Air Suspension	14QK-431M	....	....	OO	85061	89450	....
	CX Vision Models w/ Parabolic Spring	14QK-431M	....	....	OO	85061	89450	....
	CX Vision Models w/ MACK Air Suspension	SDA471700000431 14QK-3101M 471700000431	....	....	OO	85066	89448	....
	Models with 12000 lb Taperleaf Front Suspension	14QK-392AM3 14QK-396M 14QK-392AM 25625743 14QK-392BM3 14QK-392BM 14QK-396	OO	85005	89430	....	....	....
	Models with ALV Hendrickson Suspension	57241-006 57241-006L 25625223 14QK-413M6 25622221	....	....	OO	83111	....	....
	Models with HAS400 MACK Air Suspension	14QK-410M 25625234 47902-25	....	....	OO	83125	....	....
	Models with Hendrickson HA Series Air Suspension	14QK-410M3 25625254	....	....	OO	83125	....	....
		14QK-410M2	....	....	OO	83137	....	....
	Models with Hendrickson HAS-40LH Air Suspension (O.E. Number 57241-4)	14QK-413M4 57241-4	....	....	OO	83110	....	....
	Models with Hendrickson HN-2 Series Suspension	14QK-415M7 14QK-415M 25624241 60680-003L 60680-003	....	....	OO	83112	....	....
	Models with MAC AL405 Suspension	57241-006 57241-006L 14QK-413M7 25625223	....	....	OO	83111	....	....
	Models with Neway AD Air Suspension Shock w/ extended length of 21.70"	90045099 14QK-414M	....	....	OO	85906	89407	....
	Models with Neway AD Air Suspension Shock w/ extended length of 24.30"	14QK-414M2 25624351	....	....	OO	85909	....	....
Models with O.E.M. Number	141700000373 20513881	OO	85061	89450	....	....	....	

### CXN

	DayCab Models with O.E.M. Number 83000 Series	21345869	....	....	OO	....	....	83066
05-08	CXN-613 Models with 12,000 lb Front Axles	SDA141700000380 20973993 14QK-3114M	OO	85061	89450	....	....	....
	CXN-613 Models with Hendrickson 38,000 lb Rear Air Suspension	60670-006 14QK-424M 20570098 60670-006L	OO	....	....	OO	83147	....
	CXN-613 Models with O.E.M. Number	20874147 14QK-3103M	....	....	OO	....	....	83050
04-08	CXN-613 Models with Hendrickson AirTek Front Air Suspension	14QK-422M 14QK-322M 20485633 64838-002	OO	85933	89454	....	....	....
	Models with O.E.M. Number	471700000426 14QK-421M	OO	85014	....	....	....	....
	Models with Sleeper Cabs with O.E.M. Number	25625637 14QK-399M3 14QK-399M2 14QK-399M 25625635 25625636	....	....	....	OO	....	83045
08	CXN-613 Models with 40,000 lb Rear Air Suspensions	14QK-2136M 20897198	....	....	OO	85061	89450	....
05-07	CXN-613 Models w/ MACK Air Suspension	SDA471700000431 14QK-3101M	....	....	OO	85066	89448	....

### CXP

06-07	CXP-613 Day Cab Models	20874147 14QK-3103M	....	....	OO	....	....	83050
-------	------------------------	------------------------	------	------	----	------	------	-------

# APPLICATION GUIDE

Year	Fitment Notes	OEM#					
			Fleetline	GasSLX	Fleetline	GasSLX	Cab Shock/ Specialty Shock

## MACK

## MACK

### CXP (cont)

06-07	CXP-613 Models with 12,000 lb Front Axles	SDA14170000380 20973993 14QK-3114M	O	O	85061	89450	....	....	....
	CXP-613 Models with 40,000 lb Rear Air Suspensions	14QK-2136M 471700002626 20897198	O	O	....	....	85061	89450	....
	Models with Sleeper Cabs with O.E.M. Number	25625637 14QK-399M3 14QK-399M2 14QK-399M 25625635 25625636	O	O	....	....	....	....	83045

### CXU

12-19	Models with O.E.M. Number	22662254 22662259	O	O	....	....	....	....	83901
11-19	CXU613 Models with 40,000 lb Rear Air Suspensions	21462382 22202559 21462384 22202560 471700009647 471700006039 471700009646	O	O	....	....	85088	....	....
		08-19	Day Cab Models with O.E.M. Number	21490486 21345869	O	O	....	....	....
08-19	Models with 12,000 - 14,600 lb Front Axles	141700005839 SDA14170000380 20973993 21436096 141700000380 14QK-3114M	O	O	85061	89450	....	....	....
	Models with Sleeper Cabs with O.E.M. Number	25625637 14QK-399M3 14QK-399M2 14QK-399M 25625635 25625636	O	O	....	....	....	....	83045
	08-11	Models with O.E.M. Number	20874147 14QK-303M 14QK-3103M	O	O	....	....	....	83050

### DM

81-03	DM Models	....	O	O	83209	89414	83215	....	....
	Models with O.E.M. Number	14QK-2100P8 25622345	O	O	83242	....	....	....	....

### F SERIES

	F Models (exc. Eastern) 83000 Series	....	O	O	83207	....	83215	....	....
	F Models (exc. Eastern) 89000 Series	....	O	O	....	89407	....	....	....
	F Models - Eastern 83000 Series	....	O	O	83221	....	....	....	....
	F Models with Standard Suspension 85000 Series	....	O	O	....	....	85305	....	....
	Fire Truck 85000 Series	....	O	O	85302	....	....	....	....
	Fire Truck 89000 Series	....	O	O	....	89420	....	....	....
	FL Models - Western 83000 Series	14QK-2100P4 14QK-143	O	O	83207	....	....	....	....
	FL Models - Western 89000 Series	14QK-2100P4 14QK-143	O	O	....	89407	....	....	....

### GRANITE

21-24	Models with O.E.M. Number	22662254 22662259	O	O	....	....	....	....	83901
18-24	Granite 64BR & 64FR Models with 20,000 lb Front Axle	21010744	O	O	83101	....	....	....	....
	Granite 64BR & 64FR Models with 46,000 lb Mack Mride Rear Suspension	21979343 471700008934	O	O	....	....	85065	....	....
15-24	Models with 14,600 lb to 18,000 lb Multi-Leaf Front Springs	21010744 14QK-3116M	O	O	83101	....	....	....	....
	Models with Hendrickson HAS Series Rear Suspension	23568046 60675-13 22314111	O	O	....	....	85036	89405	....



# APPLICATION GUIDE

Year	Fitment Notes	OEM#					
			Fleetline	GasSLX	Fleetline	GasSLX	Cab Shock Specialty Shock

## MACK

## MACK

### GU7 (cont)

08-10	GU-713 Models with 20,000 lb Front Axles	14QK-3108M 20863239 14QK-427M 25626048 47170000445	O I	85080	....	....	....	....	....	....
-------	--	--	--------	-------	------	------	------	------	------	------

### GU8

08-19	GU813 Models with 14,600 lb to 18,000 lb Multi-Leaf Front Springs	21010744 14QK-3116M	O O	83101	....	....	....	....	....	....
	GU813 Models with Hendrickson 38,000 lb Rear Air Suspension	60670-006 14QK-424M 20570098 60670-006L	O O	....	....	....	83147	....	....	....
	GU813 Models with Hendrickson HAS 400 or 460 Series Rear Suspension	8083872 60675-001L 60675-001	O O	....	....	....	85978	....	....	....
	GU813 Models with Hendrickson HAS Series Rear Suspension	60675-13 22314111	O O	....	....	....	85036	89405	....	....
	GU813 Models with O.E.M. Number	14QK-432M 20873442  21490486 21345869  22662254 22662259	O O  O O  O O	....	....	....	....	....	....	83050  83066  83901
08-10	GU-813 Models with 20,000 lb Front Axles	14QK-3108M 20863239 14QK-427M 25626048 47170000445	O I	85080	....	....	....	....	....	....

### LE

10	LE & LEU 613 Models with Ridewell RD-202S HD Tandem Drive Truck Suspension	1252607B000	O O	....	....	....	85702	....	....	....
	LEU 613 Models with 20,000 lb Front Axle	21002497	O O	85972	....	....	....	....	....	....
	Models with Hendrickson HMX 400/460 Haulmax with 16.5" Saddle	60680-004L 60680-004	O O	....	....	....	83143	....	....	....
	Models with Hendrickson HMX 400/460 Haulmax with 17.5" & 18.5" Saddle	25626196 14QK-5142 60680-005L 60680-005 H60680-005	O O	....	....	....	83142	....	....	....
01-07	Models with Hendrickson HMX 400/460 Haulmax with 16.5" Saddle	60680-004L 60680-004	O O	....	....	....	83143	....	....	....
	Models with Hendrickson HMX 400/460 Haulmax with 17.5" & 18.5" Saddle	25626196 14QK-5142 60680-005L 60680-005 H60680-005	O O	....	....	....	83142	....	....	....
01-06	LE 613 Models with O.E.M Number	14QK-366P4 25625187	O O	83209	89414	....	....	....	....	....

### LEU

10-16	LE & LEU 613 Models with Ridewell RD-202S HD Tandem Drive Truck Suspension	1252607B000	O O	....	....	....	85702	....	....	....
	LEU 613 Models with 20,000 lb Front Axle	21002497	O O	85972	....	....	....	....	....	....
08-16	Models with Hendrickson HMX 400/460 Haulmax with 16.5" Saddle	60680-004L 60680-004	O O	....	....	....	83143	....	....	....
	Models with Hendrickson HMX 400/460 Haulmax with 17.5" & 18.5" Saddle	25626196 14QK-5142 60680-005L 60680-005 H60680-005	O O	....	....	....	83142	....	....	....
09	LEU 613 Models with 18,000 lb Front Axle	14QK-372M2 25632561	O O	83209	89414	....	....	....	....	....

### LR

19-24	LR64R Models with 20,000 lb Front Axle	21002497	O O	85972	....	....	....	....	....	....
	Models with 46,000 lb Mack Mride Rear Suspension	21979343 471700008934	O O	....	....	....	85065	....	....	....
	Models with Hendrickson HMX 400/460 Haulmax with 16.5" Saddle	60680-004L 60680-004 H60680-004	O O	....	....	....	83143	....	....	....



# APPLICATION GUIDE

Year	Fitment Notes	OEM#					
			Fleetline	GasSLX	Fleetline	GasSLX	Cab Shock/ Specialty Shock

## MACK

## MACK

### PINNACLE (cont)

18-22	Models with Hendrickson HAS 400 or 460 Series Rear Suspension	8083872 60675-001L 60675-001	....	....	OO	85978	....	....
19-21	Models with Hendrickson 40,000 lb Pimaax EX and FireMaax EX Air Suspension	20782199 60657-007	....	....	OO	85072	....	....
18-21	Pinnacle 64T Sleeper Cab Models with O.E.M. Number	23327756 23030654	....	....	OO	....	....	83910
18-19	Models with O.E.M. Number	20874147 14QK-303M 14QK-3103M	....	....	OO	....	....	83050
18	Anthem 64T Sleeper Cab Models with O.E.M. Number	23030654	....	....	OO	....	....	83910

### R

89-91	RB 600 Models (Drive Axle)	14QK-2107	....	....	OO	83215	....	....
		14QK-393M	....	....	OO	85010	....	....
81-91	Models with Cab Air suspension	14QK-2111-P4	....	....	OO	....	....	83019
	Models with Front Taperleaf Springs	25625151 14QK-366P1 14QK-366	OO	85036	89405	....	....	....
	Models with Link Cabmate Model MCR600	1201-0012 1202-0012	....	....	OO	....	....	83023
	Models with O.E.M. Number	14QK-2110 25632147 14QK-2115	OO	85305	....	....	....	....
		14QK-29302	OO	83207	89407	....	....	....
		14QK-382 14QK-382P2	OO	....	....	OO	....	....
	R, U, RD 600 Models/ MR600 Models with Front Taperleaf Springs	25625151 14QK-366P1 14QK-366	OO	85036	89405	....	....	....
R600 Models-3 1/2" Wide springs	14QK-366P1	OO	85036	89405	....	....	....	
83-85	RD Models with ST34 Suspension	25622466 14QK-2133M	OO	85001	89410	....	....	....

### RB

92-05	RB 600 Models (Drive Axle)	14QK-2107	OO	83209	89414	....	....	....
-------	----------------------------	-----------	----	-------	-------	------	------	------

### RD

07	Models with Cab Air suspension	14QK-2111-P4	....	....	OO	....	....	83019
	Models with Front Taperleaf Springs	25625151 14QK-366P1 14QK-366	OO	85036	89405	....	....	....
	Models with O.E.M. Number	14QK-2110 25632147 14QK-2115	OO	85305	....	....	....	....
		14QK-29302	OO	83207	89407	....	....	....
		14QK-382 14QK-382P2	OO	....	....	OO	....	....
	RD600 Models-3 1/2" Wide springs	14QK-366P1	OO	85036	89405	....	....	....
81-04	Models with Cab Air suspension	14QK-2111-P4	....	....	OO	....	....	83019
	Models with Front Taperleaf Springs	25625151 14QK-366P1 14QK-366	OO	85036	89405	....	....	....
	Models with O.E.M. Number	14QK-2110 25632147 14QK-2115	OO	85305	....	....	....	....
		14QK-29302	OO	83207	89407	....	....	....
		14QK-382 14QK-382P2	OO	....	....	OO	....	....
	RD600 Models-3 1/2" Wide springs	14QK-366P1	OO	85036	89405	....	....	....

### RS

81-89	Models with Link Cabmate Model MCR600	1201-0012 1202-0012	....	....	OO	....	....	83023
-------	---------------------------------------	------------------------	------	------	----	------	------	-------

# APPLICATION GUIDE

Year	Fitment Notes	OEM#					
			Fleetline	GasSLX	Fleetline	GasSLX	Cab Shock\ Specialty Shock

## MACK

## MACK

### RW

85-93	RW Models - 4" Wide Springs	14QK-373 14QK-378M 25623321	OO	83215	....	....	....	....	
	RW Models with Camelback Rear Suspension (SS34 & 38)	14QK-2107P1 25625091 14QK-2107P2		....	....	OO	83215	....	....
	RW Models with Neway ARD-234 Air Suspension	14QK-375M		....	....	OO	83123	89405	....
	RW Models with O.E.M. Number	14QK-377M	OO	83215	....		....	....	....
		14QK-2133M2 14QK-2113P5 25622466 14QK-2133M	OO	85001	89410		....	....	....
		14QK-392AM	OO	85005	89430		....	....	....
RW Models with Taperleaf Rear Suspension	14QK-2113P4	OO	....	....	OO	85007	....	....	

### TD700

10-17	TD-713 Models with 20,000 lb Front Axle	21436094	OO	85927	....	....	....	....	
	TD-713 Models with Hendrickson 38,000 lb Rear Air Suspension	60670-006 14QK-424M 20570098 60670-006L		....	....	OO	83147	....	....
	TD-713 Models with Hendrickson 40,000 lb Pimaax EX and FireMaax EX Air Suspension	20782199 60657-007		....	....	OO	85072	....	....
	TD713 Models with Hendrickson HAS 400 or 460 Series Rear Suspension	8083872 60675-001L 60675-001		....	....	OO	85978	....	....
	Titan TD713 Models with Hendrickson HAS Series Rear Suspension	60675-13 22314111	OO	....	....	OO	85036	89405	....

### TERRAPRO

18-21	Models with 20,000 lb Front Axle	14QK-3115M 21002497	OO	85972	....	....	....	....
-------	----------------------------------	------------------------	----	-------	------	------	------	------

### TITAN

10-17	Models with 20,000 lb Front Axle	21436094	OO	85927	....	....	....	....	
08-17	Models with Hendrickson 38,000 lb Rear Air Suspension	60670-006 14QK-424M 20570098 60670-006L		....	....	OO	83147	....	....
	Models with Hendrickson 40,000 lb Pimaax EX and FireMaax EX Air Suspension	20782199 60657-007		....	....	OO	85072	....	....
	Models with Hendrickson HAS 400 or 460 Series Rear Suspension	8083872 60675-001L 60675-001		....	....	OO	85978	....	....
	Models with Hendrickson HAS Series Rear Suspension	60675-13 22314111	OO	....	....	OO	85036	89405	....
08-09	Models with 20,000 lb Front Axle	14QK-493M 21155033	OO	83101	....	....	....	....	

### U

81-89	Models with Front Taperleaf Springs	25625151 14QK-366P1 14QK-366	OO	85036	89405	....	....	....
-------	-------------------------------------	------------------------------------	----	-------	-------	------	------	------

## MAN

## MAN

### VARIOUS

	Americana Bus with O.E.M. Numbers 85000 Series	81-43701-6572		85708	....	....	....	....	
		81-43701-6573		85722	....		....	....	
		81-43701-6543 25-1700-106-654		....	....		85708	....	....
		Articulating Bus - Drive Axle 85000 Series	81-43701-6537		....	....		85709	....
		Articulating Bus - Front Axle 85000 Series	81-43701-6538		85708	....		....	....
		Articulating Bus - Trailing Axle 85000 Series	81-43701-6539		....	....		85708	....



# APPLICATION GUIDE

Year	Fitment Notes	OEM#					
			Fleetline	GasSLX	Fleetline	GasSLX	Cab Shock Specialty Shock

**MAN**

**MAN**

## VARIOUS (cont)

Models with O.E.M. Number 85000 Series	134 81-43701-6609 9020M-1042	....	....	85709	....	....
--	------------------------------------	------	------	-------	------	------

**MANDALAY COACH**

**MANDALAY COACH**

## CLASS A MOTORHOMES

04-06	Mandalay Series MotorHomes with Freightliner XC Chassis ADL200 Suspension w/ 20K Rear 85000 Series	16-16873-000	....	....	85029	....	....
	Mandalay Series MotorHomes with Freightliner XC Chassis AS120 Front Suspension 83000 Series	16-16874-000 16-16737-000 141700131810	OO	83160	....	....	....
	Mandalay Series MotorHomes with Freightliner XC Chassis Rear Shock with O.E.M. Number 85000 Series	141700131809 16-16736-000	OO	....	....	85029	....
	Mandalay Series MotorHomes with Freightliner XC Chassis ZF - IFS Front Suspension with 23,000 lb GVW or Greater 85000 Series	16-18103-000 48170000493	IT	85900	....	....	....
06	Presidio & Valencia Series MotorHomes with Freightliner XC Chassis AS120 Front Suspension 83000 Series	16-16874-000 16-16737-000 141700131810	OO	83160	....	....	....
	Presidio & Valencia Series MotorHomes with Freightliner XC Chassis Rear Shock with O.E.M. Number 85000 Series	141700131809 16-16736-000	OO	....	....	85029	....
	Presidio & Valencia Series MotorHomes with Freightliner XC Chassis ZF - IFS Front Suspension with 23,000 lb GVW or Greater 85000 Series	16-18103-000 48170000493	IT	85900	....	....	....

**MC NEILUS TRUCK & MAN.**

**MC NEILUS TRUCK & MAN.**

## VARIOUS

Booster Axles Specialty Shock	1170719 600-115994B	OO	....	....	632147	....	....
Bridgemaster V models with Self - Steering Axle Shocks Specialty Shock	600-188206	OO	....	....	646155	....	....
Mc Neilus part number 83000 Series	5HB645 MTM	....	....	....	83109	....	....
	3215395 MTM 1139046 MTM	....	....	....	83112	....	....
	6HS773 MTM 7HS237 MTM	....	....	....	83122	....	....
	6HA961 MTM	....	....	....	83123	....	....
	1398980 MTM	....	....	....	83127	....	....
	64442AX MTM 1491909 MTM	....	....	....	83128	....	....
	6HB390 MTM	....	....	....	83137	....	....
	1340975 MTM	....	....	....	83142	....	....
	1340979 MTM	....	....	....	83143	....	....
	1367383 MTM	....	....	....	83147	....	....
	1411765 MTM	....	....	....	83148	....	....
	8KK524 MTM	....	....	....	83168	....	....
	1139059 MTM 3HR916 MTM	....	....	....	83207	....	....
	1139069 MTM	....	....	....	83209	....	....
	2218640 MTM	....	....	....	....	....	83009
Mc Neilus part number 85000 Series	12405FX1 MTM	OO	85303	....	....	....	....
	1139039 MTM	OO	85334	....	....	....	....
	1410046 MTM 1340976 MTM	OO	85919	....	....	....	....
	4HA569 MTM	OO	85932	....	....	....	....
	4KP398 MTM	OO	85933	....	....	....	....
	1396513 MTM	OO	85959	....	....	....	....
	6KP857 MTM	OO	....	....	85000	....	....

# APPLICATION GUIDE

Year	Fitment Notes	OEM#					
				Fleetline	GasSLX		Fleetline

## MC NEILUS TRUCK & MAN.

## MC NEILUS TRUCK & MAN.

### VARIOUS (cont)

	Mc Neilus part number 85000 Series	3HR582 MTM		....		....		85013		....		....		
		1333575 MTM		....		....		85072		....		....		
		9KK464 MTM		....		....		85079		....		....		
		1404068 MTM		....		....		85087		....		....		
		1323106 MTM		....		....		85305		....		....		
		1360386 MTM		....		....		85323		....		....		
		1468783 MTM		....		....		85345		....		....		
		1431085 MTM		....		....		85738		....		....		
		7HS534 MTM		....		....		85906		....		....		
		6HD720 MTM		....		....		85909		....		....		
		5HA994 MTM		....		....		85916		....		....		
		1433009 MTM		....		....		85962		....		....		
		1432386 MTM		....		....		85965		....		....		
		1KK552 MTM		....		....		85967		....		....		
		9HB362 MTM		....		....		85976		....		....		
		5KK247 MTM		....		....		85977		....		....		
		1485576 MTM		....		....		85979		....		....		
			Mc Neilus part number 89000 Series	12405FX1 MTM		....		89422		....		....		....
				4HA569 MTM		....		89453		....		....		....
				4KP398 MTM		....		89454		....		....		....
6HA961 MTM				....		....		89405		....		....		
6HS773 MTM 7HS237 MTM				....		....		89406		....		....		
1139059 MTM 3HR916 MTM 7HS534 MTM				....		....		89407		....		....		
3HR582 MTM 1139069 MTM				....		....		89414		....		....		
5HA994 MTM				....		....		89430		....		....		
64442AX MTM 6KP857 MTM 1491909 MTM 1360386 MTM				....		....		89436		....		....		
	Pusher Axles Specialty Shock			600-115994B		....		632147		....		....		....

## MERCEDES-BENZ

## MERCEDES-BENZ

### MP115

93-03	All	481700004801		85705		....		....		....		....
		510006		....		....		85705		....		....

### MP120

93-03	All	481700004801		85705		....		....		....		....
		510006		....		....		85705		....		....

## MERITOR

## MERITOR

### FS230 TRAILER SUSPENSION

	FS230 Trailer Suspension (Light Duty) 85000 Series	A-7805P-1030		....		....		85737		....		....
	FS230 Trailer Suspension (Std Duty) 87000 Series	A-7805L-1026		....		....		87015		....		....

# APPLICATION GUIDE

Year	Fitment Notes	OEM#					
			Fleetline	GasSLX	Fleetline	GasSLX	Cab Shock/ Specialty Shock

## MERITOR

## MERITOR

### FS230 TRAILER SUSPENSION (cont)

	FS230T 87000 Series	21227751	....	....	☉	87015	....	....
	Meritor Kit 11210 includes washers and nuts (For Shock only) 87000 Series	KIT11210	....	....	☉	87015	....	....

### MTA 25T / MTA 30T TRAILER AIR SUSPENSION

	Meritor Kit 11375 includes other components (For Shock only) 86000 Series	KIT11375	....	....	☉	86200	....	....
	Meritor Kit 11376 includes other components (For Shock only) 86000 Series	KIT11376	....	....	☉	86200	....	....
	Meritor Kit 11389 includes other components (For Shock only) 86000 Series	KIT11389	....	....	☉	86200	....	....
	Meritor Kit 11402 includes other components (For Shock only) 86000 Series	KIT11402	....	....	☉	86200	....	....
	MTA 25T / MTA 30T Trailer Air Suspension 86000 Series	A-7805F-1020 7805-F-1020	....	....	☉	86200	....	....

### RHP TRAILER SUSPENSION

01-21	RHP11, RHP55 and RideSentry Trailer Suspension 85000 Series	A-7805L-1000 A-3280-M-9711 202447	....	....	☉	85919	....	....
97-00	RHP11, RHP55 and RideSentry Trailer Suspension 85000 Series	A-3280-M-9711 202447	....	....	☉	85919	....	....

### VARIOUS

	Air Link Suspensions with O.E.M. Number 85000 Series	14QK-3100 446-51-211	....	....	☉	85739	....	....
	AL460 Air Link Suspension 85000 Series	700115	....	....	☉	85712	....	....
	AL520 Air Link Suspension 85000 Series	700115	....	....	☉	85712	....	....
	RFS 23T / 25T / 30T Trailer Air Suspensions 87000 Series	21227751 A-7805L-1026	....	....	☉	87015	....	....

## MITSUBISHI FUSO

## MITSUBISHI FUSO

### FM

89-93	FM557 Models with O.E.M. Number	MC814614	 ○	85009	....	 ○	....	....
88-91	FM555 Models with O.E.M. Number	MC814614	 ○	85009	....	 ○	....	....
86-88	Model with O.E.M. Number	MC813135	 T	....	89447	 T	....	....
	Models with O.E.M. Number	MC813135	 T	83456	....	 T	....	....

### FM330

05-11	Models with O.E.M. Number	MC091950	 ○	83162	....	 ○	....	....
-------	---------------------------	----------	-------	-------	------	-------	------	------

## MONACO COACH

## MONACO COACH

### CLASS A MOTORHOMES

	Models with Workhorse UFO Chassis with Hendrickson Softek Front Suspension 83000 Series	66153-002 F4-BE5-C832-MO	☉	83124	....	☉	....	....
	Models with Workhorse UFO Chassis with Hendrickson Softek Front Suspension 89000 Series	66153-002 F4-BE5-C832-MO	☉	....	89407	☉	....	....
98-11	All Models with W20 & W22 Workhorse Motorhome Chassis 85000 Series	24-153249 F4-BE5-B492-HO W0005662 W0006254 24153249 24-186629 F4-BE5-A832-MO F4-BE5-F324-HO	☉	85125	....	☉	....	....
04-07	Models with Roadmaster Chassis R4R, used on Cayman 83000 Series	.....	☉	83144	....	☉	....	....
00-03	Models with Roadmaster Chassis RM4C or used on Knight 83000 Series	01809924	☉	83144	....	☉	....	....
	Models with Workhorse W22 Chassis with 8.1L Gas Monarch, LaPalma 85000 Series	01809925	☉	85010	....	☉	....	....

# APPLICATION GUIDE

Year	Fitment Notes	OEM#					
				Fleetline	GasSLX		Fleetline

## MONACO COACH LA PALMA

## MONACO COACH

12-13	MotorHomes with Ford F53 Chassis with 16,000 lb GVW to 22,000 lb GVW	ASH-1229 ASH-1228 9U94-18045-AA ASH-1205 AT-620 ASH-1022 1C34-18045-AA ASH-294 9U9Z-18124-A ASH-25822 ASH-25823 1C34-18045-JA AT-766	OIO	83209	89414	....	....	....
		ASH-1206 9U94-18080-AA AT-621 ASH-25824 9U9Z-18125-A ASH-1023 ASH-1230 ASH-137	....	....	OIO	83122	89406	....
09	Models with W20 & W22 Workhorse Motorhome Chassis	24-153249 F4-BE5-B492-HO W0005662 W0006254 24-186629 F4-BE5-A832-MO F4-BE5-F324-HO	OIO	85125	....	....	....	....
		W0005663 F4-BE5-F325-HO 24-153256	....	....	I	85124	....	....
	MotorHomes with Ford F53 Chassis with 16,000 lb GVW to 22,000 lb GVW	ASH-1229 ASH-1228 9U94-18045-AA ASH-1205 AT-620 ASH-1022 1C34-18045-AA ASH-294 9U9Z-18124-A ASH-25822 ASH-25823 1C34-18045-JA AT-766	OIO	83209	89414	....	....	....
		ASH-1206 9U94-18080-AA AT-621 ASH-25824 9U9Z-18125-A ASH-1023 ASH-1230 ASH-137	....	....	OIO	83122	89406	....
07-08	MotorHomes with Ford F53 Chassis with 16,000 lb GVW to 22,000 lb GVW 83000 Series	ASH-1229 ASH-1228 9U94-18045-AA ASH-1205 AT-620 ASH-1022 1C34-18045-AA ASH-294 9U9Z-18124-A ASH-25822 ASH-25823 1C34-18045-JA AT-766	OIO	83209	....	....	....	....
		MotorHomes with Ford F53 Chassis with 16,000 lb GVW to 22,000 lb GVW 89000 Series	OIO	....	89414	....	....	....
04-06	Models with W20 & W22 Workhorse Motorhome Chassis	W0005663 F4-BE5-F325-HO 24-153256	....	....	....	I	85124	....

# APPLICATION GUIDE

Year	Fitment Notes	OEM#					
			Fleetline	GasSLX	Fleetline	GasSLX	Cab Shock Specialty Shock

## MONACO COACH

### LA PALMA (cont)

## MONACO COACH

02-06	Models with W20 & W22 Workhorse Motorhome Chassis	24-153249 F4-BE5-B492-HO W0005662 W0006254 24-186629 F4-BE5-A832-MO F4-BE5-F324-HO	O/O	85125	....	....	....	....
	MotorHomes with Ford F53 Chassis with 16,000 lb GVW to 22,000 lb GVW	ASH-1229 ASH-1228 9U94-18045-AA ASH-1205 AT-620 ASH-1022 1C34-18045-AA ASH-294 9U9Z-18124-A ASH-25822 ASH-25823 1C34-18045-JA AT-766	O/O	83209	89414	....	....	....
		ASH-1206 9U94-18080-AA AT-621 ASH-25824 9U9Z-18125-A ASH-1023 ASH-1230 ASH-137	O/O	....	....	83122	89406	....
01	MotorHomes with Ford F53 Chassis with 16,000 lb GVW to 22,000 lb GVW 83000 Series	ASH-1229 ASH-1228 9U94-18045-AA ASH-1205 AT-620 ASH-1022 1C34-18045-AA ASH-294 9U9Z-18124-A ASH-25822 ASH-25823 1C34-18045-JA AT-766	O/O	83209	....	....	....	
	MotorHomes with Ford F53 Chassis with 16,000 lb GVW to 22,000 lb GVW 89000 Series	ASH-1229 ASH-1228 9U94-18045-AA ASH-1205 AT-620 ASH-1022 1C34-18045-AA ASH-294 9U9Z-18124-A ASH-25822 ASH-25823 1C34-18045-JA AT-766	O/O	....	89414	....	....	....
00	Models with W20 & W22 Workhorse Motorhome Chassis	24-153249 F4-BE5-B492-HO W0005662 W0006254 24-186629 F4-BE5-A832-MO F4-BE5-F324-HO	O/O	85125	....	....	....	
	MotorHomes with Ford F53 Chassis with 16,000 lb GVW to 22,000 lb GVW	ASH-1229 ASH-1228 9U94-18045-AA ASH-1205 AT-620 ASH-1022 1C34-18045-AA ASH-294 9U9Z-18124-A ASH-25822 ASH-25823 1C34-18045-JA AT-766	O/O	83209	89414	....	....	....
		ASH-1206 9U94-18080-AA AT-621 ASH-25824 9U9Z-18125-A ASH-1023 ASH-1230 ASH-137	O/O	....	....	83122	89406	....

# APPLICATION GUIDE

Year	Fitment Notes	OEM#					
			Fleetline	GasSLX	Fleetline	GasSLX	Cab Shock\ Specialty Shock

## MONACO COACH

### LA PALMA (cont)

## MONACO COACH

90-99	MotorHomes with Ford F53 Chassis with 16,000 lb GVW to 22,000 lb GVW 83000 Series	ASH-1229 ASH-1228 9U94-18045-AA ASH-1205 AT-620 ASH-1022 1C34-18045-AA ASH-294 9U9Z-18124-A ASH-25822 ASH-25823 1C34-18045-JA AT-766	OIO	83209	....	....	....	....
	MotorHomes with Ford F53 Chassis with 16,000 lb GVW to 22,000 lb GVW 89000 Series	ASH-1229 ASH-1228 9U94-18045-AA ASH-1205 AT-620 ASH-1022 1C34-18045-AA ASH-294 9U9Z-18124-A ASH-25822 ASH-25823 1C34-18045-JA AT-766	OIO	....	89414	....	....	....

## MONARCH

06-14	MotorHomes with Ford F53 Chassis with 16,000 lb GVW to 22,000 lb GVW	ASH-1229 ASH-1228 9U94-18045-AA ASH-1205 AT-620 ASH-1022 1C34-18045-AA ASH-294 9U9Z-18124-A ASH-25822 ASH-25823 1C34-18045-JA AT-766	OIO	83209	89414	....	....	....
		ASH-1206 9U94-18080-AA AT-621 ASH-25824 9U9Z-18125-A ASH-1023 ASH-1230 ASH-137	OIO	....	....	83122	89406	....
06-11	Models with W20 & W22 Workhorse Motorhome Chassis	24-153249 F4-BE5-B492-HO W0005662 W0006254 24-186629 F4-BE5-A832-MO F4-BE5-F324-HO	OIO	85125	....	....	....	....
		W0005663 F4-BE5-F325-HO 24-153256	OIO	....	....	85124	....	....
03-05	MotorHomes with Ford F53 Chassis with 16,000 lb GVW to 22,000 lb GVW 83000 Series	ASH-1229 ASH-1228 9U94-18045-AA ASH-1205 AT-620 ASH-1022 1C34-18045-AA ASH-294 9U9Z-18124-A ASH-25822 ASH-25823 1C34-18045-JA AT-766	OIO	83209	....	....	....	....
	MotorHomes with Ford F53 Chassis with 16,000 lb GVW to 22,000 lb GVW 89000 Series	ASH-1229 ASH-1228 9U94-18045-AA ASH-1205 AT-620 ASH-1022 1C34-18045-AA ASH-294 9U9Z-18124-A ASH-25822 ASH-25823 1C34-18045-JA AT-766	OIO	....	89414	....	....	....

# APPLICATION GUIDE

Year	Fitment Notes	OEM#					
			Fleetline	GasSLX	Fleetline	GasSLX	Cab Shock Specialty Shock

## MONACO COACH

## MONACO COACH

### MONARCH (cont)

01-02	Models with W20 & W22 Workhorse Motorhome Chassis	24-153249 F4-BE5-B492-HO W0005662 W0006254 24-186629 F4-BE5-A832-MO F4-BE5-F324-HO	O/O	85125	....	....	....	....
	MotorHomes with Ford F53 Chassis with 16,000 lb GVW to 22,000 lb GVW	ASH-1229 ASH-1228 9U94-18045-AA ASH-1205 AT-620 ASH-1022 1C34-18045-AA ASH-294 9U9Z-18124-A ASH-25822 ASH-25823 1C34-18045-JA AT-766	O/O	83209	89414	....	....	....
		ASH-1206 9U94-18080-AA AT-621 ASH-25824 9U9Z-18125-A ASH-1023 ASH-1230 ASH-137	O/O	....	....	83122	89406	....
90-99	MotorHomes with Ford F53 Chassis with 16,000 lb GVW to 22,000 lb GVW 83000 Series	ASH-1229 ASH-1228 9U94-18045-AA ASH-1205 AT-620 ASH-1022 1C34-18045-AA ASH-294 9U9Z-18124-A ASH-25822 ASH-25823 1C34-18045-JA AT-766	O/O	83209	....	....	....	....
	MotorHomes with Ford F53 Chassis with 16,000 lb GVW to 22,000 lb GVW 89000 Series	ASH-1229 ASH-1228 9U94-18045-AA ASH-1205 AT-620 ASH-1022 1C34-18045-AA ASH-294 9U9Z-18124-A ASH-25822 ASH-25823 1C34-18045-JA AT-766	O/O	....	89414	....	....	....

### VARIOUS

95-99	MotorHomes with Freightliner XC Chassis (22,000 to 26,000 lb GVW) 83000 Series	.....	O/O	83160	....	....	....	....
	MotorHomes with Freightliner XC Chassis (22,000 to 26,000 lb GVW) 85000 Series	.....	O/O	....	....	85029	....	....

## MOR-RYDE SUSPENSION

## MOR-RYDE SUSPENSION

	Bus Suspension 83000 Series	.....		....	....	+	83103	....	....
	Recreational Vehicle 83000 Series	U0109-014		....	....	+	83400	....	....

## MOTOR COACH INDUSTRIES

## MOTOR COACH INDUSTRIES

### ADDITIONAL APPLICATIONS

	Drive Axle 85000 Series	12L-5-71		....	....	+	85708	....	....
		T14-1081		....	....	+	85729	....	....
	Low Floor Bus Models with O.E.M. Number 85000 Series	12L-5-99		....	....	+	85339	....	....
	MC5, MC7, MC8 85000 Series	680323 3178157	O/O	85700	....	+	....	....	....
	RTS Bus with "V" Drive Rear 85000 Series	G1101590GS		....	....	+	85713	....	....
	RTS Bus with Regular Rear 85000 Series	G1011822		....	....	+	85702	....	....









# APPLICATION GUIDE

Year	Fitment Notes	OEM#					
			Fleetline	GasSLX	Fleetline	GasSLX	Cab Shock/ Specialty Shock

## NATIONAL RV

## NATIONAL RV

### CLASS A MOTORHOMES (cont)

99-08	Models with Ford F53 Chassis with 16,000 lb GVW to 22,000 lb GVW 89000 Series	ASH-1229 ASH-1228 9U94-18045-AA ASH-1205 AT-620 ASH-1022 1C34-18045-AA ASH-294 9U9Z-18124-A ASH-25822 ASH-25823 1C34-18045-JA AT-766	 O 	89414	.....	.....	.....
		ASH-1206 9U94-18080-AA AT-621 ASH-25824 9U9Z-18125-A ASH-1023 ASH-1230 ASH-137	 O 	.....	.....	89406	.....
98-00	Models with Workhorse W20 , W22, & W24 MotorHome Chassis with O.E.M. Number 85000 Series	24-153249 F4-BE5-B492-HO W0005662 W0006254 24-186629 F4-BE5-A832-MO F4-BE5-F324-HO	 O 	85125	.....	.....	.....

## NEOPLAN

## NEOPLAN

### VARIOUS

	Additional O.E.M. Interchanges 85000 Series	CI 1002003	 T 	85705	.....	.....	.....
	Additional O.E.M. Interchanges 89000 Series	CI 1002003	 T 	.....	89447	.....	.....
	Mini-Bus 83000 Series	BT1002011 24-1700-106-149	 O 	.....	.....	83216	.....
	Mini-Bus 85000 Series	BN1002002 24-1700-999-362	 O 	85009	.....	.....	.....
	Model 40 85000 Series	25-1700-101-426	 T 	85705	.....	.....	.....
	Model 40 89000 Series	25-1700-101-426	 T 	.....	89447	.....	.....
	Model 80B 85000 Series	CL1002003 DZ1002002	 T 	85705	.....	.....	.....
	Model 80B 89000 Series	CL1002003 DZ1002002	 T 	.....	89447	.....	.....
	Models with O.E.M. Number 85000 Series	AA1002003 AA1802002 AA1002002 AC1002003 MM1002002 DT1802002 MM1002003 GJ1002003 AC1002002 680307 AC1002002GS	 T 	85705	.....	.....	.....
	Models with O.E.M. Number 89000 Series	AA1002003 AA1802002 AA1002002 AC1002003 MM1002002 DT1802002 MM1002003 GJ1002003 AC1002002 680307 AC1002002GS	 T 	.....	89447	.....	.....

## NEW FLYER

## NEW FLYER

	Diesel Low Floor Coach 85000 Series	015813	 T 	.....	.....	85708	.....
02-21	Transit Buses (Low Profile) with O.E.M. Number 85000 Series	152959	 T 	.....	.....	85708	.....
91-21	Transit Buses (Low Profile) with O.E.M. Number 85000 Series	016415 009863	 T 	85722	.....	.....	.....



# APPLICATION GUIDE

Year	Fitment Notes	OEM#					
			Fleetline	GasSLX	Fleetline	GasSLX	Cab Shock Specialty Shock

## ORION BUS

### VARIOUS (cont)

## ORION BUS

	Additional O.E.M. Interchanges 85000 Series	680091	O	85303	....			
		050134508 680506	OO	85732	....			
		A-4890		....	....	O	85712	....
	Additional O.E.M. Interchanges 89000 Series	680091	OO	....	89422		....	....
	Models with O.E.M. Number 85000 Series	695366 695343 695327	OO	85732	....		....	....
		695420 695440		....	....	O	85729	....
	Models with O.E.M. Number 87000 Series	695421 695389	O	87016	....		....	....
	Orion 1 85000 Series	010234503-4		....	....	O	85308	....
	Orion 1 89000 Series	010234503-4		....	....	OO	....	89422
	Orion 102 85000 Series	050134501-4	OO	85716	....		....	....
		050231505 050230501 680504		....	....	O	85716	....
	Orion II 83000 Series	020273544 020273541	OO	83203	....		....	....
	Orion II 85000 Series	20117501 020117503-4 020117504 20117505 20117504	OO	85720	....		....	....
		020273541-4		....	....	O	85000	....
		010234503-4		....	....	OO	85308	....
	Orion II 89000 Series	020273541	OO	....	89436		....	....
		020273544	OO	....	89436		....	....
		010234503-4		....	....	OO	....	89422
		020273541-4		....	....	OO	....	89436
	Orion V 85000 Series	0501345024 050134513 050134506-4 050134509 695347 010134508-4 050134511 0101345084 050134510	OO	85732	....		....	....
		050231505 680504		....	....	O	85716	....
	Orion VI (M Axle) with O.E.M. Number 87000 Series	060131507 060131508	O	87016	....		....	....
	Orion VII - 30 ft Rear 85000 Series	070231527		....	....	O	85729	....
	Orion VII with O.E.M. Number 85000 Series	070231514 6430645		....	....	O	85729	....
	Orion VII with O.E.M. Number 87000 Series	070131502 070131506	O	87016	....		....	....

## OSHKOSH MOTOR TRUCK CO.

## OSHKOSH MOTOR TRUCK CO.

	Additional O.E.M. Interchanges 83000 Series	2JD137	O	83119	....			
		40-0242	OO	83312	....			
	Additional O.E.M. Interchanges 85000 Series	40-5348	OO	85058	....		....	....
		40-4951	OO	85316	....		....	....
	Additional O.E.M. Interchanges 89000 Series	40-0242	OO	....	89409		....	....
		40-4951	OO	....	89426		....	....
		40-5348	OO	....	89431		....	....

# APPLICATION GUIDE

Year	Fitment Notes	OEM#					
			Fleetline	GasSLX	Fleetline	GasSLX	Cab Shock\ Specialty Shock

## OSHKOSH MOTOR TRUCK CO.

## OSHKOSH MOTOR TRUCK CO.

### VARIOUS (cont)

Additional O.E.M. Interchanges 89000 Series	1745500		....	....	OO	....	89430	....
Mobile Home - ForeTravel 85000 Series	1583470		....	....	OO	85051	....	....
Models with 16" Long Shock Absorber w/1" Mounting Pins 85000 Series	....	OO	85303	....	OO	....	....	....
Models with 16" Long Shock Absorber w/1" Mounting Pins 89000 Series	....	OO	....	89422	OO	....	....	....
Models with 3/4" Mounting Pins 83000 Series	....	OO	83122	....	OO	....	....	....
Models with 3/4" Mounting Pins 89000 Series	....	OO	....	89406	OO	....	....	....
Models with Link Cabmate Model OKTP with O.E.M. Number 83000 Series	1202-0054		....	....	OO	....	....	83021
Models with Newway Air Suspension 85000 Series	90044448		....	....	OO	85051	....	....
Models with O.E.M. Number 83000 Series	P117099		....	....	OO	83120	....	....
	60670-018 060670-018		....	....	OO	83166	....	....
	651444		....	....	OO	83221	....	....
	2218640		....	....	OO	....	....	83009
Models with O.E.M. Number 85000 Series	665040 12405F1 5353054 690049 12405F-1	OO	85303	....	OO	....	....	....
	12405F 5361994	OO	85734	....	OO	....	....	....
	1583470		....	....	OO	85051	....	....
Models with O.E.M. Number 89000 Series	665040 12405F1 5353054 690049 12405F-1	OO	....	89422	OO	....	....	....
Motor Homes with O.E.M. Number 83000 Series	RW24285	OO	83119	....	OO	....	....	....
	1398980	OO	83127	....	OO	....	....	....
Self - Steering Axle Shocks Specialty Shock	2034140	OO	646177			OO	....	....
V - Line Coach 83000 Series	1573280		....	....	OO	83221	....	....

## OSTERLUND TRUCK

## OSTERLUND TRUCK

Additional O.E.M. Interchanges 85000 Series	220-S5-10		....	....	OO	85712	....	....
Models with O.E.M. Number 83000 Series	59011	OO	83214	....	OO	....	....	....
Models with O.E.M. Number 85000 Series	680117	OO	85300	....	OO	....	....	....
Models with O.E.M. Number 89000 Series	680117		....	89419	OO	....	....	....

## OTTAWA

## OTTAWA

Additional O.E.M. Interchanges 85000 Series	90013787		....	....	I	85310	....	....
Additional O.E.M. Interchanges 89000 Series	90013787		....	....	I	....	89423	....
Models with O.E.M. Number 83000 Series	59011	OO	83214	....	OO	....	....	....
Models with O.E.M. Number 85000 Series	680117	OO	85300	....	OO	....	....	....
Models with O.E.M. Number 89000 Series	680117	OO	....	89419	OO	....	....	....
Yard Tractor 85000 Series	90027577	OO	85720	....	OO	....	....	....

## PACIFIC TRUCK & TRAILER

## PACIFIC TRUCK & TRAILER

Additional O.E.M. Interchanges 85000 Series	507202C1		OO	85030	....	....	....	....
Additional O.E.M. Interchanges 89000 Series	507202C1		OO	....	89440	....	....	....



# APPLICATION GUIDE

Year	Fitment Notes	OEM#					
			Fleetline	GasSLX	Fleetline	GasSLX	Cab Shock Specialty Shock

## PAGE SUSPENSION VARIOUS (cont)

## PAGE SUSPENSION

	Model with LM-2000 Models Lift Axle Suspension 83000 Series	1080099	....	....	83203	....	....
	Model with LM-2000 Models Lift Axle Suspension 89000 Series	1080099	....	....	....	89436	....
	Model with Trailmaster Air Spring Suspension 83000 Series	1081933	....	....	83204	....	....
	Model with Trailmaster Air Spring Suspension 85000 Series	A-2212	....	....	85029	....	....
	Models with O.E.M. Number 83000 Series	665133	....	....	83203	....	....
	Models with O.E.M. Number 89000 Series	665133	....	....	....	89436	....

## PAI CORP.

## PAI CORP.

	Models with O.E.M. Number 83000 Series	HSA-5095	83215	....	....	....	....
		HSA-5080	83221	....	....	....	....
	Models with O.E.M. Number 85000 Series	HSA-5067	85305	....	....	....	....

## PEERLESS TRAILER

## PEERLESS TRAILER

	Models with Air Suspension 83000 Series	72-61	....	....	83125	....	....
	Models with O.E.M. Number 83000 Series	120-1	....	....	83125	....	....

## PETERBILT

## PETERBILT

### 220

13-24	Models with 12,000 lb Front Axle	1707378PAC BFRG 072	85182	....	....	....	....
	Models with Hendrickson HAS - 210L or HAS - 230L Rear Air Suspension	60670-008PLUS-2 60670-008 60670-008L	....	....	83123	89405	....
	Models with Reyco 102 or 79KB Suspension (Drive Axle)	19495-01 16725-01 TK19679	....	....	83126	89430	....
13-22	Models with Reyco 102AR (Standard) Rear Air Suspension	12887-02 12887-01	....	....	85013	89414	....
13	Models with 12,000 lb Front Axle	B71-6016A B71-6016 02-02738	85012	89413	....	....	....
10	Models with 12,000 lb Front Axle	B71-6016A B71-6016 02-02738	85012	89413	....	....	....
	Models with Hendrickson HAS - 210L or HAS - 230L Rear Air Suspension	60670-008PLUS-2 60670-008 60670-008L	....	....	83123	89405	....
	Models with Reyco 102 or 79KB Suspension (Drive Axle)	19495-01 16725-01 TK19679	....	....	83126	89430	....
	Models with Reyco 102AR (Standard) Rear Air Suspension	12887-02 12887-01	....	....	85013	89414	....
07	Models with 12,000 lb Front Axle	B71-6016A B71-6016 02-02738	85012	89413	....	....	....
	Models with Hendrickson HAS - 210L or HAS - 230L Rear Air Suspension	60670-008PLUS-2 60670-008 60670-008L	....	....	83123	89405	....
	Models with Reyco 102 or 79KB Suspension (Drive Axle)	19495-01 16725-01 TK19679	....	....	83126	89430	....
	Models with Reyco 102AR (Standard) Rear Air Suspension	12887-02 12887-01	....	....	85013	89414	....



### 270

	Models with Woodhead Shock (Stamping Number ACHB 966) 83000 Series	ACHB966	....	....	83136	....	....
--	--	---------	------	------	-------	------	------

### 320

	Models with Neway AD-252-10 Tandem Axle 85000 Series	90045132	....	....	85909	....	....
14-18	Models with Air Trac Suspension (40,000 lb)	C71-6003	....	....	85988	....	....

# APPLICATION GUIDE

Year	Fitment Notes	OEM#					
			Fleetline	GasSLX	Fleetline	GasSLX	Cab Shock\ Specialty Shock

## PETERBILT

### 320 (cont)

10-18	Models with Neway ADZ Rear Suspension	90045812 471700013186 471700004423 90045605 90045803	...	...	85109	...	...
02-18	Models with Peterbilt Low Air Leaf Suspension	03-08781 C71-1017 C71-1011	...	...	85069	89455	...
01-18	Models with 18,000 lb to 23,000 lb Taperleaf Front Spring Suspension and Set Forward Front Axle.	02-02742 B71-6011	85062	89408	...	...	...
	Models with Hendrickson HMX 400/460 Haulmax with 16.5" Saddle	60680-004L 60680-004	...	...	83143	...	...
	Models with Hendrickson HMX 400/460 Haulmax with 17.5" & 18.5" Saddle	60680-005L 60680-005	...	...	83142	...	...
87-18	Models with 12,000 lb to 14,600 lb Taperleaf Spring Suspension and Set Forward Front Axle.	B71-6009 02-02737 02-01787	85062	89408	...	...	...
	Models with Air Trac Suspension (46,000 lb)	C71-6002 03-07421	...	...	85311	89424	...
	Models with Reyco 102 or 79KB Suspension (Drive Axle)	19495-01 16725-01 TK19679	...	...	83126	89430	...
	Models with Reyco 102AR (Standard) Rear Air Suspension	12887-01	...	...	85013	89414	...

## PETERBILT

### 330

	Models with O.E.M. Number 85000 Series	B71-6017 02-03020	85910	...	...	...	...
16-22	Models with 10,000 lb to 14,600 lb Taperleaf Springs and Set Back Front Axles	B71-6019	85989	...	...	...	...
07-22	Models with Peterbilt Low Air Leaf Suspension	03-08781 C71-1017 C71-1011	...	...	85069	89455	...
	Models with Reyco 79KB Rear Steel Spring Suspension	19495-01 16725-01 TK19679	...	...	83126	89430	...
14-21	Models with Air Trac Suspension (40,000 lb)	C71-6003	...	...	85988	...	...
07-21	Models with Air Trac Suspension (46,000 lb)	C71-6002 03-07421	...	...	85311	89424	...
	Models with Reyco 102AR (Standard) Rear Air Suspension	12887-02 12887-01	...	...	85013	89414	...
07-16	Models with 12000 lb Set Back Front Axle	B71-6016A B71-6016 02-02738	85012	89413	...	...	...
03-05	Models with Peterbilt Low Air Leaf Suspension	03-08781 C71-1017 C71-1011	...	...	85069	89455	...
95-05	Models with 12000 lb Set Back Front Axle	B71-6016A B71-6016 02-02738	85012	89413	...	...	...
	Models with Air Trac Suspension (46,000 lb)	C71-6002 03-07421	...	...	85311	89424	...
	Models with Reyco 102AR (Standard) Rear Air Suspension	12887-02 12887-01	...	...	85013	89414	...
	Models with Reyco 79KB Rear Steel Spring Suspension	19495-01 16725-01 TK19679	...	...	83126	89430	...
95-02	Models with Peterbilt 40000 lb Low Air Leaf Suspension	03-07423	...	...	85033	89427	...

### 335

05-10	Models with 12000 lb Set Back Front Axle	02-02741 B71-6016A B71-6016 02-02738	85012	89413	...	...	...
	Models with Air Trac Suspension (46,000 lb)	03-07421	...	...	85311	89424	...
	Models with Peterbilt Low Air Leaf Suspension	03-08781 C71-1017 C71-1011	...	...	85069	89455	...

### 337

15-23	Models with 10,000 lb to 14,600 lb Taperleaf Springs and Set Back Front Axles	B71-6019	85989	...	...	...	...
-------	---	----------	-------	-----	-----	-----	-----

# APPLICATION GUIDE

Year	Fitment Notes	OEM#					
			Fleetline	GasSLX	Fleetline	GasSLX	Cab Shock/ Specialty Shock

## PETERBILT

## PETERBILT

### 337 (cont)

10-23	Models with Air Trac Suspension (46,000 lb)	C71-6002 03-07421	....	....		85311	89424	....
	Models with Neway ADZ Rear Suspension	90045812 471700013186 471700004423 90045605 90045803	....	....		85109	....	....
	Models with Peterbilt Low Air Leaf Suspension	03-08781 C71-1017 C71-1011	....	....		85069	89455	....
10-22	Models with Reyco 79KB Rear Steel Spring Suspension	19495-01 16725-01 TK19679	....	....		83126	89430	....
14-21	Models with Air Trac Suspension (40,000 lb)	C71-6003	....	....		85988	....	....
10-21	Models with Reyco 102AR (Standard) Rear Air Suspension	85013A0C 12887-02 12887-01	....	....		85013	89414	....
10-14	Models with 10,000 lb to 12,000 lb Front Axle	B71-6005		85084	89460	....	....	....
	Models with 13,200 lb to 14,600 lb Front Axle	B71-6006		85084	89460	....	....	....

### 340

07-10	Models with 12000 lb Set Back Front Axle	02-02741 B71-6016A B71-6016 02-02738		85012	89413	....	....	....
	Models with Air Trac Suspension (46,000 lb)	03-07421		....	....	85311	89424	....

### 348

14-23	Models with 20,000 lb Taperleaf Springs and Set Back Front Axles	B71-6020		85989	....	....	....	....
10-23	Conventional Day Cab with O.E.M. Number	R71-6005		....	....		....	83042
	Models with Air Trac Suspension (46,000 lb)	C71-6002 03-07421		....	....	85311	89424	....
	Models with Hendrickson HMX 400/460 Haulmax with 16.5" Saddle	60680-004L 60680-004		....	....	83143	....	....
	Models with Hendrickson HMX 400/460 Haulmax with 17.5" & 18.5" Saddle	60680-005L 60680-005		....	....	83142	....	....
	Models with Neway ADZ Rear Suspension	90045812 471700013186 471700004423 90045605 90045803		....	....	85109	....	....
	Models with Reyco 79KB Rear Steel Spring Suspension	19495-01 16725-01 TK19679		....	....	83126	89430	....
14-22	Models with 10,000 lb to 14,600 lb Taperleaf Springs and Set Back Front Axles	B71-6019		85989	....	....	....	....
14-21	Models with Air Trac Suspension (40,000 lb)	C71-6003		....	....	85988	....	....
10-21	Models with Reyco 102AR (Standard) Rear Air Suspension	12887-02 12887-01		....	....	85013	89414	....
10-20	Day Cab Models with O.E.M. Number	1202-0054		....	....	....	....	83021
	Models with Sleepers with O.E.M. Number	25523024 R71-6009 1201-8002		....	....	....	....	83081
18	Day Cab Models with O.E.M. Number	25523002 1201-8001		....	....	....	....	83908
15-16	Models with O.E.M. Number	B71-6012		85119	....	....	....	....
12-13	Models with 10,000 lb to 12,000 lb Front Axle	B71-6005		85084	89460	....	....	....
81-84	Day Cab Models with O.E.M. Number	1202-0054		....	....	....	....	83021

### 349

84-87	349 Conventional Models with 12000 lb capacity	02-00495 02-00376 02-02736		85302	89420	....	....	....
-------	--	----------------------------------	--	-------	-------	------	------	------

# APPLICATION GUIDE

Year	Fitment Notes	OEM#					
			Fleetline	GasSLX	Fleetline	GasSLX	Cab Shock\ Specialty Shock

## PETERBILT

## PETERBILT

### 353

81-88	353 Conventional Models with 12000 lb capacity	02-00495 02-00376 02-02736	OO	85302	89420			
-------	--	----------------------------------	----	-------	-------	--	--	--

### 357

02-08	Models with Hendrickson HMX 400/460 Haulmax with 16.5" Saddle	60680-004L 60680-004				O	83143	....	....
	Models with Hendrickson HMX 400/460 Haulmax with 17.5" & 18.5" Saddle	60680-005L 60680-005				O	83142	....	....
	Models with Peterbilt Low Air Leaf Suspension	03-08781 C71-1017				I	85069	89455	....
97-08	Models with Air Track Tandem with TRD8000 Pusher Axle	03-08350 C71-6004				I	85343	....	....
87-08	Conventional Models with Spring Suspension and with Set Back Front Axle.	02-02741 B71-6016A B71-6016 02-01890 02-02738	OO	85012	89413		....	....	....
	Models with 12,000 lb to 14,600 lb Taperleaf Spring Suspension and Set Forward Front Axle.	B71-6009 B71-6007 02-02737	OO	85062	89408		....	....	....
	Models with 18,000 lb to 23,000 lb Taperleaf Front Spring Suspension and Set Forward Front Axle.	02-02742 B71-6011	OO	85062	89408		....	....	....
	Models with Air Trac Suspension (46,000 lb)	03-07421		....	....	I	85311	89424	....
	Models with Chalmers 40,000 lb Rear Suspension	800670 665174		....	....	O	85060	....	....
	Models with Neway ARD 125/244-8 Models Rear Air Suspension	90044011		....	....	O	85004	....	....
86-08	Conventional Models with Front Air Suspension and Set Back Front Axle.	02-02739	OO	85013	89414		....	....	....
	Conventional Models with Front Air Suspension and without Set Back Front Axle.	02-02740	OO	85036	89405		....	....	....
	Models with Link Cabmate Models PBC377 & PBC377-A	1202-0054		....	....	O	....	....	83021
87-01	Models with Peterbilt Low Air Leaf Suspension	665633 03-07423		....	....	I	85033	89427	....

### 359

81-88	359 Conventional Truck & Tractors with Link Cabmate Models PBC379 & PBC379-A	1202-0054				OO	....	....	83021
81-87	359 Conventional Models with 12000 lb capacity	02-00495 02-00376 02-02736	OO	85302	89420		....	....	....
	359 Models (Older Models) Conventional Tractors with Link Cabmate Model PBCAL359	1201-0012 1202-0012		....	....	O	....	....	83023
	Models with Air Trac Suspension (46,000 lb)	03-07421		....	....	I	85311	89424	....

### 362

	C.O.E. Models with 12000 lb capacity 85000 Series	02-02736	OO	85302	....		....	....	....
	C.O.E. Models with 12000 lb capacity 89000 Series	02-02736	OO	....	89420		....	....	....
	Models with Air Trac Suspension (38000 or 40000 lb) To 11/82 85000 Series	03-04176		....	....	O	85308	....	....
	Models with Air Trac Suspension (38000 or 40000 lb) To 11/82 89000 Series	03-04176		....	....	O	....	89422	....
02-06	Models with Peterbilt Low Air Leaf Suspension	03-08781 C71-1017		....	....	I	85069	89455	....
86-06	C.O.E. Models with 14600 lb Taper Leaf Springs and Set Back Front Axle	02-02740	OO	85036	89405		....	....	....
81-06	C.O.E. Models with Progressive Springs	B71-6016A B71-6016 02-02738	OO	85012	89413		....	....	....
	C.O.E. Models without Set Back Front Axle	02-00495 02-00376	OO	85302	89420		....	....	....
	Models with Air Trac Suspension (46,000 lb)	03-07421		....	....	I	85311	89424	....
	Models with Chalmers 40,000 lb Rear Suspension	800670 665174		....	....	O	85060	....	....
	Models with Link Cabmate Model PB-362-2P	1202-0032		....	....	O	....	....	83016
	Models with Neway ARD 125/244-8 Models Rear Air Suspension	90044011		....	....	O	85004	....	....



# APPLICATION GUIDE

Year	Fitment Notes	OEM#					
			Fleetline	GasSLX	Fleetline	GasSLX	Cab Shock\ Specialty Shock

## PETERBILT

### 367 (cont)

08-19	Models with Chalmers 40,000 lb Rear Suspension	800670 665174		....	....		85060	....	....
08-16	Models with 10,000 lb to 16,000 lb Taperleaf Front Spring Suspension and with Set Back Front Axle.	B71-6016 B71-6002		85012	89413		....	....	....

## PETERBILT

### 372

89-93	C.O.E. Models with Front Air Suspension	02-02739		85013	89414		....	....	....
	C.O.E. Models with Front Spring Suspension	B71-6016A B71-6016 02-02738		85012	89413		....	....	....
	Models with Air Trac Suspension (46,000 lb)	03-07421		....	....		85311	89424	....
	Models with Chalmers 40,000 lb Rear Suspension	800670 665174		....	....		85060	....	....
	Models with Neway ARD 125/244-8 Models Rear Air Suspension	90044011		....	....		85004	....	....
	Models with Peterbilt Low Air Leaf Suspension	665633 03-07423		....	....		85033	89427	....

### 375

87-96	Conventional Models with Front Air Suspension and Set Back Front Axle.	02-02739		85013	89414		....	....	....
	Conventional Models with Front Air Suspension and without Set Back Front Axle.	02-02740		85036	89405		....	....	....
	Conventional Models with Spring Suspension and with Set Back Front Axle.	02-02741 B71-6016A B71-6016 02-02738		85012	89413		....	....	....
	Models with 12,000 lb to 14,600 lb Taperleaf Spring Suspension and Set Forward Front Axle.	B71-6009 B71-6007 02-02737		85062	89408		....	....	....
	Models with 18,000 lb to 23,000 lb Taperleaf Front Spring Suspension and Set Forward Front Axle.	02-02742 B71-6011		85062	89408		....	....	....
	Models with Air Trac Suspension (46,000 lb)	03-07421		....	....		85311	89424	....
	Models with Chalmers 40,000 lb Rear Suspension	800670 665174		....	....		85060	....	....
	Models with Link Cabmate Models PBC377 & PBC377-A	1202-0054		....	....		....	....	83021
	Models with Neway ARD 125/244-8 Models Rear Air Suspension	90044011		....	....		85004	....	....
	Models with Peterbilt Low Air Leaf Suspension	665633 03-07423		....	....		85033	89427	....

### 376

02	Models with 12,000 lb to 14,600 lb Taperleaf Spring Suspension and Set Forward Front Axle. 85000 Series	B71-6009 B71-6007 02-02737		85062	....		....	....	....
	Models with 12,000 lb to 14,600 lb Taperleaf Spring Suspension and Set Forward Front Axle. 89000 Series	B71-6009 B71-6007 02-02737		....	89408		....	....	....
	Models with 18,000 lb to 23,000 lb Taperleaf Front Spring Suspension and Set Forward Front Axle. 85000 Series	02-02742 B71-6011		85062	....		....	....	....
	Models with 18,000 lb to 23,000 lb Taperleaf Front Spring Suspension and Set Forward Front Axle. 89000 Series	02-02742 B71-6011		....	89408		....	....	....
	Models with Air Trac Suspension (46,000 lb) 85000 Series	03-07421		....	....		85311	....	....
	Models with Air Trac Suspension (46,000 lb) 89000 Series	03-07421		....	....		....	89424	....
00	Models with 12,000 lb to 14,600 lb Taperleaf Spring Suspension and Set Forward Front Axle. 85000 Series	B71-6009 B71-6007 02-02737		85062	....		....	....	....
	Models with 12,000 lb to 14,600 lb Taperleaf Spring Suspension and Set Forward Front Axle. 89000 Series	B71-6009 B71-6007 02-02737		....	89408		....	....	....
	Models with 18,000 lb to 23,000 lb Taperleaf Front Spring Suspension and Set Forward Front Axle. 85000 Series	02-02742 B71-6011		85062	....		....	....	....
	Models with 18,000 lb to 23,000 lb Taperleaf Front Spring Suspension and Set Forward Front Axle. 89000 Series	02-02742 B71-6011		....	89408		....	....	....
	Models with Air Trac Suspension (46,000 lb) 85000 Series	03-07421		....	....		85311	....	....
	Models with Air Trac Suspension (46,000 lb) 89000 Series	03-07421		....	....		....	89424	....
99	Conventional Models with Front Air Suspension and Set Back Front Axle.	02-02739		85013	89414		....	....	....

# APPLICATION GUIDE

Year	Fitment Notes	OEM#					
			Fleetline	GasSLX	Fleetline	GasSLX	Cab Shock/ Specialty Shock

## PETERBILT

## PETERBILT

### 376 (cont)

99	Conventional Models with Front Air Suspension and without Set Back Front Axle.	02-02740	O O	85036	89405	 O	....	....	....
	Conventional Models with Spring Suspension and with Set Back Front Axle.	02-02741 B71-6016A B71-6016 02-02738	O O	85012	89413	 O	....	....	....
	Models with 12,000 lb to 14,600 lb Taperleaf Spring Suspension and Set Forward Front Axle.	B71-6009 B71-6007 02-02737	O O	85062	89408	 O	....	....	....
	Models with 18,000 lb to 23,000 lb Taperleaf Front Spring Suspension and Set Forward Front Axle.	02-02742 B71-6011	O O	85062	89408	 O	....	....	....
	Models with Air Trac Suspension (46,000 lb)	03-07421	 O	....	....	 O	85311	89424	....
	Models with Chalmers 40,000 lb Rear Suspension	800670 665174	 O	....	....	 O	85060	....	....
	Models with Neway ARD 125/244-8 Models Rear Air Suspension	90044011	 O	....	....	 O	85004	....	....
	Models with Peterbilt Low Air Leaf Suspension	665633 03-07423	 O	....	....	 O	85033	89427	....
95-96	Models with 12,000 lb to 14,600 lb Taperleaf Spring Suspension and Set Forward Front Axle.	B71-6009 B71-6007 02-02737	O O	85062	89408	 O	....	....	....
	Models with 18,000 lb to 23,000 lb Taperleaf Front Spring Suspension and Set Forward Front Axle.	02-02742 B71-6011	O O	85062	89408	 O	....	....	....
94-96	Conventional Models with Front Air Suspension and Set Back Front Axle.	02-02739	O O	85013	89414	 O	....	....	....
	Conventional Models with Front Air Suspension and without Set Back Front Axle.	02-02740	O O	85036	89405	 O	....	....	....
	Conventional Models with Spring Suspension and with Set Back Front Axle.	02-02741 B71-6016A B71-6016 02-02738	O O	85012	89413	 O	....	....	....
	Models with Air Trac Suspension (46,000 lb)	03-07421	 O	....	....	 O	85311	89424	....
	Models with Chalmers 40,000 lb Rear Suspension	800670 665174	 O	....	....	 O	85060	....	....
	Models with Neway ARD 125/244-8 Models Rear Air Suspension	90044011	 O	....	....	 O	85004	....	....
	Models with Peterbilt Low Air Leaf Suspension	665633 03-07423	 O	....	....	 O	85033	89427	....
88-92	Conventional Models with Front Air Suspension and Set Back Front Axle.	02-02739	O O	85013	89414	 O	....	....	....
	Conventional Models with Front Air Suspension and without Set Back Front Axle.	02-02740	O O	85036	89405	 O	....	....	....
	Conventional Models with Spring Suspension and with Set Back Front Axle.	02-02741 B71-6016A B71-6016 02-02738	O O	85012	89413	 O	....	....	....
	Models with Air Trac Suspension (46,000 lb)	03-07421	 O	....	....	 O	85311	89424	....
	Models with Chalmers 40,000 lb Rear Suspension	800670 665174	 O	....	....	 O	85060	....	....
	Models with Neway ARD 125/244-8 Models Rear Air Suspension	90044011	 O	....	....	 O	85004	....	....
	Models with Peterbilt Low Air Leaf Suspension	665633 03-07423	 O	....	....	 O	85033	89427	....
92	Models with 12,000 lb to 14,600 lb Taperleaf Spring Suspension and Set Forward Front Axle.	B71-6009 B71-6007 02-02737	O O	85062	89408	 O	....	....	....
	Models with 18,000 lb to 23,000 lb Taperleaf Front Spring Suspension and Set Forward Front Axle.	02-02742 B71-6011	O O	85062	89408	 O	....	....	....
88-90	Models with 12,000 lb to 14,600 lb Taperleaf Spring Suspension and Set Forward Front Axle.	B71-6009 B71-6007 02-02737	O O	85062	89408	 O	....	....	....
	Models with 18,000 lb to 23,000 lb Taperleaf Front Spring Suspension and Set Forward Front Axle.	02-02742 B71-6011	O O	85062	89408	 O	....	....	....

### 377

	Conventional Models with Unibuilt Cab 83000 Series	R71-6007 29-02455	 O	....	....	 O	....	....	83008
99-01	Models with O.E.M. Number	R71-6007 29-02455	 O	....	....	 O	....	....	83008
87-01	Conventional Models with Front Air Suspension and Set Back Front Axle.	02-02739	O O	85013	89414	 O	....	....	....



# APPLICATION GUIDE

Year	Fitment Notes	OEM#					
			Fleetline	GasSLX	Fleetline	GasSLX	Cab Shock\ Specialty Shock

## PETERBILT

## PETERBILT

### 377 (cont)

87-01	Conventional Models with Front Air Suspension and without Set Back Front Axle.	02-02740	O	O	85036	89405	....	....	....
	Conventional Models with Spring Suspension and with Set Back Front Axle.	02-02741 02-02738	O	O	85012	89413	....	....	....
	Models with 12,000 lb to 14,600 lb Taperleaf Spring Suspension and Set Forward Front Axle.	B71-6009 B71-6007 02-02737	O	O	85062	89408	....	....	....
	Models with 18,000 lb to 23,000 lb Taperleaf Front Spring Suspension and Set Forward Front Axle.	02-02742 B71-6011	O	O	85062	89408	....	....	....
	Models with Air Trac Suspension (46,000 lb)	03-07421	I	O	....	....	85311	89424	....
	Models with Chalmers 40,000 lb Rear Suspension	800670 665174	O	O	....	....	85060	....	....
	Models with Link Cabmate Models PBC379 & PBC379-A	1202-0054	O	O	....	....	....	....	83021
	Models with Neway ARD 125/244-8 Models Rear Air Suspension	90044011	O	O	....	....	85004	....	....
	Models with Peterbilt Low Air Leaf Suspension	665633 03-07423	I	O	....	....	85033	89427	....

### 378

03-07	Models with Peterbilt Low Air Leaf Suspension	03-08781 C71-1017	I	O	....	....	85069	89455	....
99-07	Models with FlexAir Suspension (38000 lb)	C71-1002 C71-6000	O	O	....	....	85067	89451	....
88-07	Conventional Models with Front Air Suspension and Set Back Front Axle.	02-02739	O	O	85013	89414	....	....	....
	Conventional Models with Front Air Suspension and without Set Back Front Axle.	02-02740	O	O	85036	89405	....	....	....
	Conventional Models with Spring Suspension and with Set Back Front Axle.	02-02741 B71-6016A B71-6016 02-02738	O	O	85012	89413	....	....	....
	Models with 12,000 lb to 14,600 lb Taperleaf Spring Suspension and Set Forward Front Axle.	B71-6009 B71-6007 02-02737 02-01787	O	O	85062	89408	....	....	....
	Models with 18,000 lb to 23,000 lb Taperleaf Front Spring Suspension and Set Forward Front Axle.	02-02742 B71-6011	O	O	85062	89408	....	....	....
	Models with Air Trac Suspension (46,000 lb)	03-07421	I	O	....	....	85311	89424	....
	Models with Chalmers 40,000 lb Rear Suspension	800670 665174	O	O	....	....	85060	....	....
	Models with Link Cabmate Models PBC377 & PBC377-A	1202-0054	O	O	....	....	....	....	83021
Models with Neway ARD 125/244-8 Models Rear Air Suspension	90044011	O	O	....	....	85004	....	....	
88-02	Models with Peterbilt Low Air Leaf Suspension	665633 03-07423	I	O	....	....	85033	89427	....

### 379

	Conventional Models with Unibuilt Cab 83000 Series	R71-6007 29-02455	O	O	....	....	....	....	83008
03-07	Models with Peterbilt Low Air Leaf Suspension	03-08781 C71-1017 C71-1011	I	O	....	....	85069	89455	....
99-07	Models with FlexAir Suspension (38000 lb)	C71-1002 C71-6000	O	O	....	....	85067	89451	....
	Models with O.E.M. Number	R71-6007 29-02455	O	O	....	....	....	....	83008
86-07	Conventional Models with Front Air Suspension and Set Back Front Axle.	02-02739	O	O	85013	89414	....	....	....
	Conventional Models with Front Air Suspension and without Set Back Front Axle.	02-02740	O	O	85036	89405	....	....	....
	Conventional Models with Spring Suspension and with Set Back Front Axle.	02-02741 B71-6016A B71-6016 02-01890 02-02738	O	O	85012	89413	....	....	....
	Models with 12,000 lb to 14,600 lb Taperleaf Spring Suspension and Set Forward Front Axle.	B71-6009 B71-6007 02-02737 02-01787	O	O	85062	89408	....	....	....
	Models with 18,000 lb to 23,000 lb Taperleaf Front Spring Suspension and Set Forward Front Axle.	02-02742 B71-6011	O	O	85062	89408	....	....	....

# APPLICATION GUIDE

Year	Fitment Notes	OEM#					
			Fleetline	GasSLX	Fleetline	GasSLX	Cab Shock/ Specialty Shock

## PETERBILT

## PETERBILT

### 379 (cont)

86-07	Models with Air Trac Suspension (46,000 lb)	03-07421SPL 03-07421	....	....		85311	89424	....
	Models with Chalmers 40,000 lb Rear Suspension	800670 665174	....	....		85060	....	....
	Models with Link Cabmate Models PBC379 & PBC379-A	1202-0054	....	....		....	....	83021
86-02	Models with Peterbilt Low Air Leaf Suspension	665633 03-07423	....	....		85033	89427	....

### 382

11-17	Models with 10,000 lb to 12,000 lb Front Axle	B71-6005	O	85084	89460		....	....	....
	Models with 12,000 lb to 14,600 lb Taperleaf Spring Suspension and Set Forward Front Axle.	B71-6009 02-02737	O	85062	89408		....	....	....
	Models with Air Trac Suspension (46,000 lb)	C71-6002 03-07421	O	....	....		85311	89424	....
	Models with FlexAir Suspension (38000 lb)	C71-1016 C71-1002 C71-6015 C71-6000	O	....	....		85067	89451	....
	Models with Peterbilt Low Air Leaf Suspension	03-08781 C71-1017 C71-1011	O	....	....		85069	89455	....
	Models with Reyco 102AR (Standard) Rear Air Suspension	12887-02 12887-01	O	....	....		85013	89414	....
	Models with Reyco 79KB Rear Steel Spring Suspension	19495-01 16725-01 TK19679	O	....	....		83126	89430	....

### 384

08-16	Conventional Day Cab with O.E.M. Number	R71-6005 20-16755	O	....	....		....	....	83042
	Models with 12,000 lb to 14,600 lb Taperleaf Spring Suspension and Set Forward Front Axle. (Heavy Duty)	B71-6009 02-02737	O	85062	89408		....	....	....
	Models with 12,000 lb to 14,600 lb Taperleaf Spring Suspension and Set Forward Front Axle. (Std Duty)	B71-6009	O	83219	....		....	....	....
	Models with Air Trac Suspension (46,000 lb)	C71-6002 03-07421	O	....	....		85311	89424	....
	Models with FlexAir Suspension (38000 lb)	C71-1016 C71-1002 C71-6015 C71-6000	O	....	....		85067	89451	....
	Models with Peterbilt Low Air Leaf Suspension	03-08781 C71-1017 C71-1011	O	....	....		85069	89455	....

### 385

	Models with 12,000 lb to 14,600 lb Taperleaf Spring Suspension and Set Forward Front Axle. To 2007 85000 Series	B71-6009 B71-6007 02-02737	O	85062	....		....	....	....
	Models with 12,000 lb to 14,600 lb Taperleaf Spring Suspension and Set Forward Front Axle. To 2007 89000 Series	B71-6009 B71-6007 02-02737	O	....	89408		....	....	....
	Models with 18,000 lb to 23,000 lb Taperleaf Front Spring Suspension and Set Forward Front Axle. To 2007 85000 Series	02-02742 B71-6011	O	85062	....		....	....	....
	Models with 18,000 lb to 23,000 lb Taperleaf Front Spring Suspension and Set Forward Front Axle. To 2007 89000 Series	02-02742 B71-6011	O	....	89408		....	....	....
	Models with Chalmers 40,000 lb Rear Suspension 85000 Series	800670 665174	O	....	....		85060	....	....
	Models with Neway ARD 125/244-8 Models Rear Air Suspension 85000 Series	90044011	O	....	....		85004	....	....
04-07	Models with Peterbilt Low Air Leaf Suspension	03-08781 C71-1017	O	....	....		85069	89455	....
95-07	Conventional Models with Spring Suspension and with Set Back Front Axle.	02-02741 B71-6016A B71-6016 02-02738	O	85012	89413		....	....	....
	Models with Air Trac Suspension (46,000 lb)	03-07421	O	....	....		85311	89424	....
	Models with FlexAir Suspension (38000 lb)	C71-1002 C71-6000	O	....	....		85067	89451	....
95-02	Models with Peterbilt Low Air Leaf Suspension	665633 03-07423	O	....	....		85033	89427	....



# APPLICATION GUIDE

Year	Fitment Notes	OEM#					
			Fleetline	GasSLX	Fleetline	GasSLX	Cab Shock\ Specialty Shock

## PETERBILT

## PETERBILT

### 388 (cont)

08-15	388 Models with 70" Sleepers	R71-6007 29-02455		....	....		....	....	83008	
	Conventional Day Cab with O.E.M. Number	R71-6005 20-16755		....	....		....	....	83042	
	Conventional Models with Front Air Suspension and Set Back Front Axle.	85013A0C 02-02739	O O	85013	89414		....	....	....	
	Conventional Models with Front Air Suspension and without Set Back Front Axle.	02-02740	O O	85036	89405		....	....	....	
	Conventional Models with Spring Suspension and with Set Back Front Axle.	02-04010 B71-6018	O O	85012	89413		....	....	....	
	Models with 12,000 lb to 14,600 lb Taperleaf Spring Suspension and Set Forward Front Axle.	B71-6007	O O	85062	89408		....	....	....	
	Models with 18,000 lb to 23,000 lb Taperleaf Front Spring Suspension and Set Forward Front Axle.	02-02742 B71-6011	O O	85062	89408		....	....	....	
	Models with Air Trac Suspension (46,000 lb)	C71-6002 03-07421		....	....		 O	85311	89424	....
	Models with FlexAir Suspension (38000 lb)	C71-1016 C71-1002 C71-6015 C71-6000		....	....		O O O	85067	89451	....
	Models with Hendrickson HMX 400/460 Haulmax with 16.5" Saddle	60680-004L 60680-004		....	....		O 	83143	....	....
	Models with Hendrickson HMX 400/460 Haulmax with 17.5" & 18.5" Saddle	60680-005L 60680-005		....	....		O 	83142	....	....
	Models with Peterbilt Air Leaf Suspension	03-07421PLUS 03-07421		....	....		 O	85311	89424	....
Models with Peterbilt Low Air Leaf Suspension	03-08781 C71-1017 C71-1011		....	....		 	85069	89455	....	
06-07	Conventional Day Cab with O.E.M. Number 83000 Series	R71-6005 20-16755		....	....		....	....	83042	

### 389

15-24	Models with O.E.M. Number	B71-6012		85119	....		....	....	....	
14-24	Models with Air Trac Suspension (40,000 lb)	C71-6003		....	....		 O	85988	....	....
	Models with Air Trac Suspension (46,000 lb)	C71-6002		....	....		 O	85311	89424	....
08-24	389 Models with 52" , 72" , and 78" Sleepers	R71-6007 29-02455		....	....		O O	....	....	83008
	Models with 12,000 lb to 14,600 lb Taperleaf Spring Suspension and Set Forward Front Axle.	B71-6009 B71-6007 02-02737	O O	85062	89408		....	....	....	
	Models with FlexAir Suspension (38000 lb)	C71-1016 C71-1002 C71-6015 C71-6000		....	....		O O O	85067	89451	....
	Models with Hendrickson HMX 400/460 Haulmax with 16.5" Saddle	60680-004L 60680-004		....	....		O 	83143	....	....
	Models with Hendrickson HMX 400/460 Haulmax with 17.5" & 18.5" Saddle	60680-005L 60680-005		....	....		O 	83142	....	....
Models with Peterbilt Low Air Leaf Suspension	03-08781 C71-1017 C71-6005 C71-1011		....	....		 	85069	89455	....	
21-23	Conventional Day Cab with O.E.M. Number	R71-6005		....	....		....	....	83042	
14-23	Models with Neway ADZ Rear Suspension	90045812 471700013186 471700004423 90045605 90045803		....	....		O O	85109	....	....
08-23	Models with 18,000 lb to 23,000 lb Taperleaf Front Spring Suspension and Set Forward Front Axle.	02-02742 B71-6011	O O	85062	89408		....	....	....	
08-22	Conventional Models with Front Air Suspension and Set Back Front Axle.	02-02739	O O	85013	89414		....	....	....	
08-21	Conventional Models with Front Air Suspension and without Set Back Front Axle.	02-02740	O O	85036	89405		....	....	....	
	Conventional Models with Spring Suspension and with Set Back Front Axle.	02-04010 B71-6018 B71-6013	O O	85012	89413		....	....	....	
08-20	Conventional Day Cab with O.E.M. Number	R71-6005 20-16755		....	....		....	....	83042	

# APPLICATION GUIDE

Year	Fitment Notes	OEM#					
			Fleetline	GasSLX	Fleetline	GasSLX	Cab Shock\ Specialty Shock

## PETERBILT

### 389 (cont)

08-19	Models with Hendrickson HN - 522 Rear Suspension	60680-003L 60680-003					83112	....	....
08-13	Models with Peterbilt Air Leaf Suspension	03-07421					85311	89424	....

### 520

17-24	Models with 18,000 lb to 23,000 lb Taperleaf Front Spring Suspension and Set Forward Front Axle.	B71-6011					....	....	....
	Models with Hendrickson HMX 400/460 Haulmax with 17.5" & 18.5" Saddle	60680-005L 60680-005					83142	....	....
17-23	Models with Air Trac Suspension (46,000 lb)	C71-6002					85311	89424	....
	Models with Neway ADZ Rear Suspension	90045812 471700013186 471700004423 90045605 90045803					85109	....	....
	Models with Peterbilt Low Air Leaf Suspension	C71-1017 C71-1011					85069	89455	....
17-22	Models with Air Trac Suspension (40,000 lb)	C71-6003					85988	....	....
	Models with Hendrickson HMX 400/460 Haulmax with 16.5" Saddle	60680-004L 60680-004					83143	....	....
	Models with Reyco 102AR (Standard) Rear Air Suspension	12887-02 12887-01					85013	89414	....
	Models with Reyco 79KB Rear Steel Spring Suspension	19495-01 16725-01 TK19679					83126	89430	....
17-19	Models with Neway AD-252-10 Tandem Axle	90045132					85909	....	....

### 537

22-24	Models with 10,000 lb to 14,600 lb Taperleaf Springs and Set Back Front Axles	B71-6019					....	....	....
	Models with Air Trac Suspension (40,000 lb)	C71-6003					85988	....	....
	Models with Peterbilt Low Air Leaf Suspension	C71-1017					85069	89455	....
	Models with Reyco 102 or 79KB Suspension (Drive Axle)	19495-01 16725-01 TK19679					83126	89430	....
22	Models with 16,000 lb to 20,000 lb Taperleaf Springs and Set Back Front Axles	B71-6020					....	....	....

### 548

22-24	Models with 10,000 lb to 14,600 lb Taperleaf Springs and Set Back Front Axles	B71-6019					....	....	....
	Models with 20,000 lb Taperleaf Springs and Set Back Front Axles	B71-6020					....	....	....
	Models with Air Trac Suspension (40,000 lb)	C71-6003					85988	....	....
	Models with Hendrickson HMX 400/460 Haulmax with 16.5" Saddle	60680-004L 60680-004					83143	....	....
	Models with Hendrickson HMX 400/460 Haulmax with 17.5" & 18.5" Saddle	60680-005L 60680-005					83142	....	....
22-23	Models with Peterbilt Low Air Leaf Suspension	C71-6005					85069	89455	....

### 567

22-24	Models with Air Track Tandem with TRD8000 Pusher Axle	C71-6004					85343	....	....
	Models with O.E.M. Number	B71-6012					....	....	....
16-24	Day Cab Models with O.E.M. Number	25523002 1201-8001					....	....	83908
	Sleeper Cab models with O.E.M. Number (Shocks only)	25523024 1201-8006					....	....	83081
14-24	Models with 12,000 lb to 14,600 lb Taperleaf Spring Suspension and Set Forward Front Axle.	B71-6009					....	....	....
	Models with Air Trac Suspension (40,000 lb)	C71-6003					85988	....	....
	Models with Air Trac Suspension (46,000 lb)	C71-6002					85311	89424	....

# APPLICATION GUIDE

Year	Fitment Notes	OEM#					
			Fleetline	GasSLX	Fleetline	GasSLX	Cab Shock/ Specialty Shock

## PETERBILT

## PETERBILT

### 567 (cont)

14-24	Models with FlexAir Suspension (38000 lb)	C71-1016 C71-6015	....	....	O	85067	89451	....
	Models with Hendrickson HMX 400/460 Haulmax with 16.5" Saddle	60680-004L 60680-004	....	....	O	83143	....	....
	Models with Hendrickson HMX 400/460 Haulmax with 17.5" & 18.5" Saddle	60680-005L 60680-005	....	....	O	83142	....	....
	Models with Neway ADZ Rear Suspension	90045812 471700013186 471700004423 90045605 90045803	....	....	O	85109	....	....
	Models with Peterbilt Low Air Leaf Suspension	C71-1017 C71-6005	....	....	O	85069	89455	....
14-23	Models with 10,000 lb to 14,600 lb Taperleaf Springs and Set Back Front Axles	B71-6019	O	85989	....	....	....	....
	Models with 18,000 lb to 23,000 lb Taperleaf Front Spring Suspension and Set Forward Front Axle.	B71-6011	O	85062	89408	....	....	....
	Models with 20,000 lb Taperleaf Springs and Set Back Front Axles	B71-6020	O	85989	....	....	....	....
14-20	Models with Watson & Chalin SL Series Steerable Lift Axle (8,000 to 13,500 lb)	11418 11418WAC	....	....	O	....	....	646177
14-19	Models with Chalmers 40,000 lb Rear Suspension	800670 665174	....	....	O	85060	....	....

### 579

16-24	Sleeper Cab models with O.E.M. Number (Shocks only)	25523024 1201-8006	....	....	O	....	....	83081
14-24	Models with Air Trac Suspension (40,000 lb)	C71-6003	....	....	O	85988	....	....
13-24	Models with 10,000 lb to 14,600 lb Taperleaf Springs and Set Back Front Axles	B71-6019	O	85989	....	....	....	....
	Models with Air Trac Suspension (46,000 lb)	C71-6002 03-07421	....	....	O	85311	89424	....
	Models with FlexAir Suspension (38000 lb)	C71-1016 C71-1002 C71-6015 C71-6000	....	....	O	85067	89451	....
	Models with Neway ADZ Rear Suspension	90045812 471700013186 471700004423 90045605 90045803	....	....	O	85109	....	....
	Models with Peterbilt Low Air Leaf Suspension	03-08781 C71-1017 C71-6005 C71-1011	....	....	O	85069	89455	....
	Models with Reyco 79KB Rear Steel Spring Suspension	19495-01 16725-01 TK19679	....	....	O	83126	89430	....
16-23	Day Cab Models with O.E.M. Number	25523002 1201-8001	....	....	O	....	....	83908
13-22	Models with O.E.M. Number	B71-6012	O	85119	....	....	....	....
	Models with Reyco 102AR (Standard) Rear Air Suspension	12887-02 12887-01	....	....	O	85013	89414	....
13-21	Models with Peterbilt Front Air Leaf Suspension	B71-6000	O	85959	....	....	....	....
13-18	Models with 12,000 lb to 14,600 lb Taperleaf Spring Suspension and Set Forward Front Axle.	B71-6009 02-02737	O	85062	89408	....	....	....
13-16	Day Cab Models with 10,000 lb to 12,000 lb Front Axle	B71-6005	O	85084	89460	....	....	....

### 587

11-18	587 Models with 70" Sleepers	R71-6008 29-06032	....	....	O	....	....	83035
	Models with 12,000 lb to 14,600 lb Taperleaf Spring Suspension and Set Forward Front Axle.	B71-6009 02-02737	O	85062	89408	....	....	....
	Models with Air Trac Suspension (46,000 lb)	C71-6002 03-07421	....	....	O	85311	89424	....
	Models with FlexAir Suspension (38000 lb)	C71-1016 C71-1002 C71-6015 C71-6000	....	....	O	85067	89451	....





# APPLICATION GUIDE

Year	Fitment Notes	OEM#					
			Fleetline	GasSLX	Fleetline	GasSLX	Cab Shock/ Specialty Shock

## PIERCE MFG. INC.

### VARIOUS (cont)

## PIERCE MFG. INC.

19-23	Models with International HV Chassis with Hendrickson Primaax 230/460 Air Suspension with 9" Ride Height 85000 Series	60657-003 3626571C2 60657-003L	....	....	OO	85072	....	....
	Models with International HV Chassis with Link Cab Mate Suspension 83000 Series	1201-9008 2509223C92 2509223C91	....	....	OO	....	....	83054
20-22	Models with International MV Chassis with 20,000 lb IROS Air Suspension 85000 Series	6127713C2	....	....	OO	85656	....	....
19-22	Models with International MV Chassis with 9,000 to 10,000 lb Front Suspension 83000 Series	6127088C1	OO	83163	....	....	....	....
	Models with International MV Chassis with Hendrickson HAS - 230 Rear Air Suspension 85000 Series	60675-003 H60675-003 3514952C1 60675-003L	....	....	OO	85976	....	....
03-22	Models with Freightliner M2 112 Chassis (Crew Cab Models with O.E.M. Number) 83000 Series	18-41762-000 814903003528 18-60764-000	....	....	OO	....	....	83038
19-21	Models with International HV Chassis with 16,000 lb to 23,000 lb Parabolic Taperleaf Springs 85000 Series	3576464C2	OO	85957	....	....	....	....
	Models with International HV Chassis with 18,000 to 20,000 lb (Set Forward) Front Axle 85000 Series	3868265C1	OO	85995	....	....	....	....

## POWERHOUSE COACH INC.

## POWERHOUSE COACH INC.

11-22	Models with Volvo VNL780 Chassis with 40,000 lb Rear Air Suspension 85000 Series	21462380 471700006040	....	....	OO	85088	....	....
06-19	Models with Volvo VNL780 Chassis with Hendrickson Airtek 85000 Series	64838-003L 21137330 20485633 20485632 471700003832 64838-003	OO	85933	....	....	....	....
	Models with Volvo VNL780 Chassis with Hendrickson Airtek 89000 Series	64838-003L 21137330 20485633 20485632 471700003832 64838-003	OO	....	89454	....	....	....
06-11	Models with Volvo VNL780 Chassis with 40,000 lb Rear Air Suspension 85000 Series	20551628 471700000443	....	....	OO	85066	....	....
	Models with Volvo VNL780 Chassis with 40,000 lb Rear Air Suspension 89000 Series	20551628 471700000443	....	....	OO	....	89448	....
06-10	Models with Volvo VNL780 Chassis with 12,500 - 14,600 lb Front Axle 85000 Series	20973993 20433424	OO	85061	....	....	....	....
	Models with Volvo VNL780 Chassis with 12,500 - 14,600 lb Front Axle 89000 Series	20973993 20433424	OO	....	89450	....	....	....

## POWERPACKER

## POWERPACKER

	Models with PowerPacker Cab Suspension 83000 Series	PP1058870	....	....	OO	....	....	83059
--	---	-----------	------	------	----	------	------	-------

## PREVOST

## PREVOST

	LeMirage XL 40 ft, 45 ft, & H3-45 VIP Coaches with I-Beam Front Suspension 85000 Series	630134 481700999376	OO	85329	....	....	....	....
	X3-45 Bus Drive and Tag Axle Shocks 85000 Series	630253	OO	....	....	OO	85713	....
07-09	XL II MTH Bus Drive and Tag Axle Shocks 85000 Series	630253	OO	....	....	OO	85713	....
04-09	H3 Bus, H3 VIP Bus Drive and Tag Axle Shocks 85000 Series	630253	OO	....	....	OO	85713	....
	H3 Bus, H3 VIP Bus With I-Beam Front Suspension 85000 Series	630252	OO	85329	....	....	....	....
04-06	XL II Bus, XL II MTH Bus Drive and Tag Axle Shocks 85000 Series	630253	OO	....	....	OO	85713	....
	XL II Bus, XL II MTH Bus With I-Beam Front Suspension 85000 Series	630252	OO	85329	....	....	....	....
99-03	XL II Bus, XL II MTH Bus Drive and Tag Axle Shocks 85000 Series	481700999386 630127 650407	OO	....	....	OO	85736	....
	XL II Bus, XL II MTH Bus With I-Beam Front Suspension 85000 Series	630134 481700999376	OO	85329	....	....	....	....
96-03	H3 Bus, H3 VIP Bus Drive and Tag Axle Shocks 85000 Series	481700999386 630127 650407	OO	....	....	OO	85736	....
	H3 Bus, H3 VIP Bus With I-Beam Front Suspension 85000 Series	630134 481700999376	OO	85329	....	....	....	....

# APPLICATION GUIDE

Year	Fitment Notes	OEM#					
			Fleetline	GasSLX	Fleetline	GasSLX	Cab Shock\ Specialty Shock

## PREVOST

## PREVOST

### VARIOUS (cont)

89-00	XL-45 Coach Drive and Tag Axle Shocks 85000 Series	481700999386 630127 650407	...	...	OO	85736	...	...
	XL-45 Coach With I-Beam Front Suspension 85000 Series	630134 481700999376	OO	85329	...	...	...	...

## RAMERIZ TRAILER

## RAMERIZ TRAILER

### TRAILER

	86 AR / RS 1015, 1035, 3015, 3035 Slider Air Suspension 85000 Series	18165-01	...	...	OO	85006	...	...
--	--	----------	-----	-----	----	-------	-----	-----

## RAYDAN MANUFACTURING

## RAYDAN MANUFACTURING

### VARIOUS

	Air Link Suspensions with O.E.M. Number 85000 Series	14QK-3100 446-51-211	...	...	OO	85739	...	...
	AL460 Air Link Suspension 85000 Series	700115	...	...	OO	85712	...	...
	AL520 Air Link Suspension 85000 Series	700115	...	...	OO	85712	...	...

## RED LION TRAILER

## RED LION TRAILER

	Trailers with Neway Air Susp. RL196-14, -15 85000 Series	90044978	...	...	OO	85059	...	...
--	--	----------	-----	-----	----	-------	-----	-----

## RENEGADE

## RENEGADE

	All Models with Freightliner Airliner Rear Air Suspension To 2019 85000 Series	16-18708-000 SDA471700002809	...	...	OO	85724	...	...
	All Models with Freightliner Airliner Rear Air Suspension To 2019 89000 Series	16-18708-000 SDA471700002809	...	...	OO	...	89443	...
16-19	Verona & Verona LE Series Motorhomes with Freightliner M2-106 Chassis 85000 Series	10-13760-000 471700002991 SDA471700002991	OO	85959	...	...	...	...
15-19	Renegade XL Series Motorhomes with Freightliner Cascadia Chassis and 12,000 to 13,300 lb Taperleaf Front Suspension 85000 Series	SDA471700003920 10-13809-000	OO	85958	...	...	...	...
12-19	Ikon Series Motorhomes with Freightliner Cascadia Chassis and 12,000 to 13,300 lb Taperleaf Front Suspension 85000 Series	SDA471700003920 10-13809-000	OO	85958	...	...	...	...
09-19	Models with Freightliner M2-112 Chassis with 12000 lb to 20000 Front Axle 85000 Series	10-13809-000 471700003920	OO	85958	...	...	...	...
11-18	Models with Volvo VNL630 Chassis with 40,000 lb Rear Air Suspension 85000 Series	21462380 471700006040	OO	...	...	85088	...	...
06-11	Models with Volvo VNL630 Chassis with 40,000 lb Rear Air Suspension 85000 Series	20551628 471700000443	OO	...	...	85066	...	...
	Models with Volvo VNL630 Chassis with 40,000 lb Rear Air Suspension 89000 Series	20551628 471700000443	OO	...	...	...	89448	...
06-10	Models with Volvo VNL630 Chassis with 12,500 - 14,600 lb Front Axle 85000 Series	20973993 20433424	OO	85061	...	...	...	...
	Models with Volvo VNL630 Chassis with 12,500 - 14,600 lb Front Axle 89000 Series	20973993 20433424	OO	...	89450	...	...	...

## REX MIXER

## REX MIXER

	Rear Discharge Mixers with Self - Steering Axle Shock Specialty Shock	102-13441-10	OO	...	...	646155	...	...
--	---	--------------	----	-----	-----	--------	-----	-----

## REYCO SUSPENSION

## REYCO SUSPENSION

### DRIVE AXLE

	101A, 101AR Models 85000 Series	18166-01	...	...	OO	85704	...	...
	102 Models 83000 Series	19495-01 16725-01	...	...	OO	83126	...	...
	102 Models 89000 Series	19495-01 16725-01	...	...	OO	...	89430	...
	102AR (Hvy Duty) Models 89000 Series	18286-01	...	...	OO	...	89414	...
	102AR (Special) Models 83000 Series	17146-01	...	...	OO	83209	...	...
	102AR (Special) Models 89000 Series	17146-01	...	...	OO	...	89414	...
	102AR (Standard) Models 85000 Series	12887-02 12887-01	...	...	OO	85013	...	...

# APPLICATION GUIDE

Year	Fitment Notes	OEM#					
			Fleetline	GasSLX	Fleetline	GasSLX	Cab Shock Specialty Shock

## REYCO SUSPENSION

### DRIVE AXLE (cont)

102AR (Standard) Models 89000 Series	12887-02 12887-01	....	....	☉	....	89414	....	....
102AR for Western Star Models 85000 Series	19824-01	....	....	☉	85006	....	....	....
102AR-7 Models 83000 Series	17794-01	....	....	☉	83215	....	....	....
102AR-LM Models 83000 Series	19623-01	....	....	☉	83123	....	....	....
102AR-LM Models 89000 Series	19623-01	....	....	☉	....	89405	....	....
102W Drive Models 85000 Series	21497-01	....	....	☉	85005	....	....	....
102W Drive Models 89000 Series	21497-01	....	....	☉	....	89430	....	....
200 Models Air Suspension 85000 Series	20129-01	....	....	☉	85007	....	....	....
200 Models Air Suspension With O.E.M. Number 85000 Series	22062-01	....	....	☉	85007	....	....	....
21AR - 25000 lb Capacity 85000 Series	12887-02 12887-01	....	....	☉	85013	....	....	....
21AR - 25000 lb Capacity 89000 Series	12887-02 12887-01	....	....	☉	....	89414	....	....
240AR Air-Ride Suspension 89000 Series	20126-01	....	....	☉	....	89440	....	....
240AR Air-Ride Suspension With O.E.M. Number 85000 Series	20129-01	....	....	☉	85007	....	....	....
	20125-01	....	....	☉	85030	....	....	....
240AR Air-Ride Suspension With O.E.M. Number 89000 Series	20125-01 20126-01	....	....	☉	....	89440	....	....
74AR - 30000 lb Capacity 85000 Series	12887-02 12887-01	....	....	☉	85013	....	....	....
74AR - 30000 lb Capacity 89000 Series	12887-02 12887-01	....	....	☉	....	89414	....	....
79AR Models 85000 Series	12887-02	....	....	☉	85013	....	....	....
79AR Models 89000 Series	12887-02	....	....	☉	....	89414	....	....
79KB Models 83000 Series	19495-01 16725-01	....	....	☉	83126	....	....	....
79KB Models 89000 Series	19495-01 16725-01	....	....	☉	....	89430	....	....
AirGlide 400 Air Suspension 85000 Series	20129-01	....	....	☉	85007	....	....	....

## REYCO SUSPENSION

### STEER AXLE

1200 (Spartan Option) Models 85000 Series	21310-01	☉	85307	....	☉	....	....	....
1207 Models 83000 Series	17403-01	☉	83122	....	☉	....	....	....
1207 Models 89000 Series	17403-01	☉	....	89406	☉	....	....	....
1209 (Alternate) Models 85000 Series	17408-01	☉	85005	....	☉	....	....	....
1209 (Alternate) Models 89000 Series	17408-01	☉	....	89430	☉	....	....	....
1209, 1212 Models 83000 Series	17358-01 19495-01	☉	83126	....	☉	....	....	....
1209, 1212 Models 89000 Series	17358-01 19495-01	☉	....	89430	☉	....	....	....

### TRAILER

19AR / RS1062 Models with Unit # 700649-01 to -06 83000 Series	700098-01	....	....	☉	83128	....	....	....
19AR / RS1062 Models with Unit # 700649-01 to -06 89000 Series	700098-01	....	....	☉	....	89436	....	....
19AR / RS1062 Models with Unit # 700649-07 to -12 85000 Series	24392-01	....	....	☉	85051	....	....	....
20 AR / RS 3162 Models with O.E.M. number 83000 Series	18163-01	....	....	☉	83207	....	....	....
20 AR / RS 3162 Models with O.E.M. number 89000 Series	18163-01	....	....	☉	....	89407	....	....
20AR & 22AR Models with O.E.M. Number 85000 Series	700098-03	....	....	☉	85052	....	....	....
21B (Special) Models 83000 Series	18800-01	....	....	☉	83203	....	....	....
21B (Special) Models 89000 Series	18800-01	....	....	☉	....	89436	....	....

# APPLICATION GUIDE

Year	Fitment Notes	OEM#					
			Fleetline	GasSLX	Fleetline	GasSLX	Cab Shock Specialty Shock

## REYCO SUSPENSION TRAILER (cont)

## REYCO SUSPENSION

	23 ARTB-14A, -15A, 16A or -19A Models 85000 Series	23523-01				85086	....	....
	23 ARTB-14A-FS Models 85000 Series	702135-01				85045	....	....
	23 ARTU Models (All except -14A-FS and , -15A-FS) 85000 Series	23523-01				85086	....	....
	23 ARTU-14A-FS and -15A-FS Models 85000 Series	702135-01				85045	....	....
	23 ARTUL Models (All except -14A-FS and , -15A-FS) 85000 Series	23523-01				85086	....	....
	25 ARTB-13A, -14A, -15A, -16A, -17A Models 85000 Series	24392-01				85051	....	....
	25 ARTBL-13A, -14A, -15A, -16A, -17A, -18A, -19A Models 85000 Series	24392-01				85051	....	....
	25 ARTBL-14A-FS, -15A-FS, -16A-FS, -17A-FS Models 85000 Series	702135-01				85045	....	....
	25 ARTBL-18A-FS, -19A-FS, -20A-FS Models 85000 Series	704672-01				85938	....	....
	25 ARTU Models ( All except -12A-FS ) 85000 Series	24392-01				85051	....	....
	25 ARTU-12A-FS 85000 Series	702136-01				85052	....	....
	25 ARTUL-13A, -13S, -14A, -14S, -15A, -15S, -16A, -16S, -17A, -17S, -18A, -18S, -19A, -19S Models 85000 Series	24392-01				85051	....	....
	25 ARTUL-18A-FS, -19A-FS, -20A-FS, -21A-FS, -22A-FS, -23A-FS, -24A-FS, -18-FS, -19-FS, -20-FS, -21-FS, -22-FS, -23-FS, -24-FS Models 85000 Series	704672-01				85938	....	....
	25 ARUU Models ( All except -06-5A-NZ ) 85000 Series	23553-01				85938	....	....
	25 ARUU-06-5A-NZ Models 85000 Series	702136-01				85052	....	....
	25 ARUUL-09A, -09A-99, -9S, -09S-99 Models 85000 Series	702135-01				85045	....	....
	25 ARUUL-10A, -10S, -11A, -11S, -12A, -12S, -13A, -13S, -14A, -14S, -15A, -15S Models 85000 Series	23553-01				85938	....	....
	30 ART with O.E.M. Number 85000 Series	23524-01				85738	....	....
	30 ARTB-14A, -15A, -16A, -17A, -18A, -19A, -20A Models 85000 Series	23524-01				85738	....	....
	30 ARTB-19A-FS, -20A-FS Models 85000 Series	23553-01				85938	....	....
	30 ARTBL-15A, -16A, -17A, -18A, -19A Models 85000 Series	23524-01				85738	....	....
	30 ARTBL-19A-FS, -20A-FS Models 85000 Series	23553-01				85938	....	....
	30 ARTU-14A, -14S, -15A, -15S, -16A, -16S, -17A, -17S, -18A, -18S, -19A, -19S, -20A Models 85000 Series	23524-01				85738	....	....
	30 ARTU-20A-FS Models 85000 Series	23553-01				85938	....	....
	30 ARTUL-15A, -15S, -16A, -16S, -17A, -17S, -18A, -19A, -19S, -20A-TTN Models 85000 Series	23524-01				85738	....	....
	30 ARTUL-20A-FS Models 85000 Series	23553-01				85938	....	....
	30 ARUU - 14 and -15 Models 85000 Series	23553-01				85938	....	....
	30 ARUU - 9, -12 and -17 Models 85000 Series	23524-01				85738	....	....
	30 ARUUL - 12 and -17 Models 85000 Series	23524-01				85738	....	....
	30 ARUUL - 9, -14 and -15 Models 85000 Series	23553-01				85938	....	....
	44 AR Models 83000 Series	19623-01				83123	....	....
	44 AR Models 89000 Series	19623-01				....	89405	....
	81C Models 85000 Series	12885-03				85300	....	....
	81C Models 89000 Series	12885-03				....	89419	....
	81LC Models 85000 Series	12885-01				85300	....	....
	81LC Models 89000 Series	12885-01				....	89419	....
	81LM Models 85000 Series	12886-01				85334	....	....
	81S Models 85000 Series	12885-03				85300	....	....
	81S Models 89000 Series	12885-03				....	89419	....

# APPLICATION GUIDE

Year	Fitment Notes	OEM#	 Fleetline    GasSLX		 Fleetline    GasSLX    Cab Shock\ Specialty Shock		
------	---------------	------	-------------------------	--	---	--	--

## REYCO SUSPENSION

## REYCO SUSPENSION

### TRAILER (cont)

86 AR / RS 1015, 1035, 3015, 3035 Slider Air Suspension 85000 Series	18165-01	....	....	85006	....	....
87 for Great Dane Models 83000 Series	18164-01	....	....	83122	....	....
	18163-01	....	....	83207	....	....
87 for Great Dane Models 89000 Series	18164-01	....	....	....	89406	....
	18163-01	....	....	....	89407	....
87-14, -17 Models 85000 Series	16230-01	....	....	85702	....	....
87-14, -17 Slider Models 85000 Series	12885-01	....	....	85300	....	....
87-14, -17 Slider Models 89000 Series	12885-01	....	....	....	89419	....
87-6, 87-9 Models 85000 Series	12885-01	....	....	85300	....	....
87-6, 87-9 Models 89000 Series	12885-01	....	....	....	89419	....

### VARIOUS

L132 Steering Stabilizer Specialty Shock	701071-01		665937
--	-----------	--	--------

## RIDEWELL CORP.

## RIDEWELL CORP.

### BUS AND R.V. AIR-RIDES

Mobile Home & RV with Air Suspension 83000 Series	AS563B S6009B	....	....	83203	....	....
Mobile Home & RV with Air Suspension 89000 Series	AS563B S6009B	....	....	....	89436	....

### TRAILER AIR-RIDES

Models with O.E.M. Number 85000 Series	57645 1275943B	....	....	85005	....	....
Models with O.E.M. Number 89000 Series	57645 1275943B	....	....	....	89430	....
RAR - 244 FeatherRide Light Duty Air Suspension (8,000 lb Capacity) 85000 Series	1270007	....	....	85045	....	....
RAR-210 For Trailers with 25" Drop 85000 Series	1253069B000 AS30698 AS3069B	....	....	85005	....	....
RAR-210 For Trailers with 25" Drop 89000 Series	1253069B000 AS30698 AS3069B	....	....	....	89430	....
RAR-210 Tag Axle 83000 Series	AS563B S6009B	....	....	83203	....	....
RAR-210 Tag Axle 89000 Series	AS563B S6009B	....	....	....	89436	....
RAR-210 With Double Convolution Spring 83000 Series	S5878B	....	....	83207	....	....
RAR-210 With Double Convolution Spring 85000 Series	AS789B	....	....	85014	....	....
RAR-210 With Double Convolution Spring 89000 Series	S5878B	....	....	....	89407	....
RAR-210 With Shock Absorber Bracket 2-1/2" Above Frame Rail 85000 Series	....	....	....	85006	....	....
RAR-210 With Shock Absorber Bracket 2-7/8" Above Lower Frame Rail 83000 Series	....	....	....	83207	....	....
RAR-210 With Shock Absorber Bracket 2-7/8" Above Lower Frame Rail 89000 Series	....	....	....	....	89407	....
RAR-210 With Shock Absorber Bracket 3" Above Lower Frame Rail 85000 Series	....	....	....	85005	....	....
RAR-210 With Shock Absorber Bracket 3" Above Lower Frame Rail 89000 Series	....	....	....	....	89430	....
RAR-210 With Shock Absorber Bracket Even With Underside of Frame 85000 Series	AS546B	....	....	85006	....	....
RAR-221 Tag Axle 83000 Series	AS563B S6009B	....	....	83203	....	....
	S5878B	....	....	83207	....	....
RAR-221 Tag Axle 85000 Series	AS789B	....	....	85014	....	....
RAR-221 Tag Axle 89000 Series	S5878B	....	....	....	89407	....





# APPLICATION GUIDE

Year	Fitment Notes	OEM#					
			Fleetline	GasSLX	Fleetline	GasSLX	Cab Shock/ Specialty Shock

## RIDEWELL CORP.

## RIDEWELL CORP.

### TRUCK AIR-RIDES (cont)

RAD-221R Drive Axle 85000 Series	S2607B							85702		
RCA-215 Models Air Suspension (RCA-215 LM, RCA-215 MM) 85000 Series	1250789B000							85014		
RD-202B Tandem Drive Axle 85000 Series	S5478B							85307		
RD-202S-54-48-BS Tandem Drive Air Suspension 85000 Series	1252607B000							85702		
RD-202S-54-52T-SR Tandem Drive Air Suspension 85000 Series	1252607B000							85702		
RSS-236, RSS-236R Self Steering Tag/Pusher Lift Axle (For 13000 lb & 16000 lb Capacity) 85000 Series	1253069B000 AS30698 AS3069B							85005		
RSS-236, RSS-236R Self Steering Tag/Pusher Lift Axle (For 13000 lb & 16000 lb Capacity) 89000 Series	1253069B000 AS30698 AS3069B								89430	
RUA-220B-1-, 10, 10.5, 11, 11.5, 12, 12.5, 13 (Lift Tag Axle & Trailer Lift Suspension) 85000 Series	1250789B000 AS789B000							85014		
RUA-220B-1-, 7, 7.5, 8, 8.5, 9, 9.5, 10 (Lift Tag Axle & Trailer Lift Suspension) 85000 Series	1270563B000							85000		
RUA-220B-1-, 7, 7.5, 8, 8.5, 9, 9.5, 10 (Lift Tag Axle & Trailer Lift Suspension) 89000 Series	1270563B000								89436	

### VARIOUS

RLT-230 Specialty Shock	1310002							665937		
RSS-232 Specialty Shock	1317570B001							646155		
RSS-236/R Specialty Shock	1310002 1310004							665937		

## ROADMASTER (MONACO)

## ROADMASTER (MONACO)

Models with AD-123 Models Suspension (AD123-6,-8,-10,-8.75) 85000 Series	90045132							85909		
Models with O.E.M. Number 85000 Series	90045188							85910		

## SAF HOLLAND

## SAF HOLLAND

### TRAILER AIR SUSPENSION

AirLite 2 Model Trailer Air Suspension 83000 Series	90044025							83209		
AirLite 2 Model Trailer Air Suspension 89000 Series	90044025								89414	
AR-120 Models Trailer Air Suspension (AR-120, AR-120-L, AR-120-US, AR-120-US-F) 83000 Series	90044626							83126		
AR-120 Models Trailer Air Suspension (AR-120, AR-120-L, AR-120-US, AR-120-US-F) 89000 Series	90044626								89430	
AR-120 Models Trailer Air Suspension (AR-120-US-L, -1, -2, -3) 83000 Series	90044625							83125		
AR-125 Models Trailer Air Suspension (AR-125, AR-125-L, AR-125-US, AR-125-US-F) 83000 Series	90044626							83126		
AR-125 Models Trailer Air Suspension (AR-125, AR-125-L, AR-125-US, AR-125-US-F) 89000 Series	90044626								89430	
AR-125 Models Trailer Air Suspension (AR-125-US-L, -1, -2, -3) 83000 Series	90044625							83125		
AR-165-US Models Trailer Air Suspension (AR165-US) 83000 Series	90044626							83126		
AR-165-US Models Trailer Air Suspension (AR165-US) 89000 Series	90044626								89430	
AR-250 Models Trailer Air Suspension (AR-250-12) 85000 Series	90045054							85051		
AR-250 Models Trailer Air Suspension (AR-250-14, -15) 83000 Series	90044642							83127		
AR-250 Models Trailer Air Suspension (AR-250-16, -17) 83000 Series	90044089							83124		
AR-250 Models Trailer Air Suspension (AR-250-16, -17) 89000 Series	90044089								89407	
AR-41 Models Trailer Air Suspension (All) 83000 Series	90044162							83128		
AR-41 Models Trailer Air Suspension (All) 89000 Series	90044162								89436	
AR-45 Models Trailer Air Suspension (AR-45, AR-45-1) 83000 Series	90044162							83128		
AR-45 Models Trailer Air Suspension (AR-45, AR-45-1) 89000 Series	90044162								89436	



# APPLICATION GUIDE

Year	Fitment Notes	OEM#					
			Fleetline	GasSLX	Fleetline	GasSLX	Cab Shock\ Specialty Shock

## SAF HOLLAND

## SAF HOLLAND

### TRAILER AIR SUSPENSION (cont)

AR-50 Models Trailer Air Suspension (AR-50-US, AR-50-US-F,-1,-2) 83000 Series	90044162	....	....	○	83128	....	....
AR-50 Models Trailer Air Suspension (AR-50-US, AR-50-US-F,-1,-2) 89000 Series	90044162	....	....	○	....	89436	....
AR-51 Models Trailer Air Suspension (AR51-US) 83000 Series	90044162	....	....	○	83128	....	....
AR-51 Models Trailer Air Suspension (AR51-US) 89000 Series	90044162	....	....	○	....	89436	....
AR-70 Models Trailer Air Suspension (AR-70-9, -14, AR-70A-9, 14) 83000 Series	90044626	....	....	○	83126	....	....
AR-70 Models Trailer Air Suspension (AR-70-9, -14, AR-70A-9, 14) 89000 Series	90044626	....	....	○	....	89430	....
AR-75 Models Trailer Air Suspension (AR-75-12) 83000 Series	90044625	....	....	○	83125	....	....
AR-75 Models Trailer Air Suspension (AR-75-6, -9, -1-12) 83000 Series	90044626	....	....	○	83126	....	....
AR-75 Models Trailer Air Suspension (AR-75-6, -9, -1-12) 89000 Series	90044626	....	....	○	....	89430	....
AR-80 Models Trailer Air Suspension (AR-80-6.75) 83000 Series	90044046	....	....	○	83123	....	....
AR-80 Models Trailer Air Suspension (AR-80-6.75) 89000 Series	90044046	....	....	○	....	89405	....
AR-80 Models Trailer Air Suspension (AR-80-9, -9FM) 85000 Series	90044868	....	....	○	85045	....	....
AR-80 Models Trailer Air Suspension (AR-80-9-WST) 83000 Series	90044626	....	....	○	83126	....	....
AR-80 Models Trailer Air Suspension (AR-80-9-WST) 89000 Series	90044626	....	....	○	....	89430	....
AR-85-A Models Trailer Air Suspension (AR-85-A) 83000 Series	90044625	....	....	○	83125	....	....
AR-90 Models Trailer Air Suspension (AR-90-14, -15, -16, -17) 83000 Series	90044089	....	....	○	83124	....	....
AR-90 Models Trailer Air Suspension (AR-90-14, -15, -16, -17) 89000 Series	90044089	....	....	○	....	89407	....
AR-90-1 Models Trailer Air Suspension (AR-90-1-12, -14, -17) 83000 Series	90044162	....	....	○	83128	....	....
AR-90-1 Models Trailer Air Suspension (AR-90-1-12, -14, -17) 89000 Series	90044162	....	....	○	....	89436	....
AR-90-1 Models Trailer Air Suspension (AR-90-1-15, -16) 85000 Series	90044448 90045054	....	....	○	85051	....	....
AR-92 Models Trailer Air Suspension (AR-92-12) 83000 Series	90044162	....	....	○	83128	....	....
AR-92 Models Trailer Air Suspension (AR-92-12) 85000 Series	90044992	....	....	○	85000	....	....
AR-92 Models Trailer Air Suspension (AR-92-12) 89000 Series	90044992 90044162	....	....	○	....	89436	....
AR-92 Models Trailer Air Suspension (AR-92-14) 83000 Series	90045040	....	....	○	83130	....	....
AR-92 Models Trailer Air Suspension (AR-92-15) 85000 Series	90044448 90045054	....	....	○	85051	....	....
AR-92 Models Trailer Air Suspension (AR-92-16) 83000 Series	90044794	....	....	○	83127	....	....
AR-92 Models Trailer Air Suspension (AR-92-17) 83000 Series	90044642	....	....	○	83127	....	....
AR-92 Models Trailer Air Suspension (AR-92-18) 83000 Series	90044089	....	....	○	83124	....	....
	90044769	....	....	○	83207	....	....
AR-92 Models Trailer Air Suspension (AR-92-18) 89000 Series	90044089 90044769	....	....	○	....	89407	....
AR-93 Models Trailer Air Suspension (AR-93-14) 85000 Series	90044448 90045054	....	....	○	85051	....	....
AR-93 Models Trailer Air Suspension (AR-93-15) 83000 Series	90044794	....	....	○	83127	....	....
AR-93 Models Trailer Air Suspension (AR-93-16) 83000 Series	90044642	....	....	○	83127	....	....
AR-93 Models Trailer Air Suspension (AR-93-17) 83000 Series	90044089	....	....	○	83124	....	....
	90044769	....	....	○	83207	....	....
AR-93 Models Trailer Air Suspension (AR-93-17) 89000 Series	90044089 90044769	....	....	○	....	89407	....
AR-95 Models Trailer Air Suspension (AR-95-9, -12, -14, -17, All -HD Models, AR-95A-9, -12, -14, -17) 83000 Series	90044625	....	....	○	83125	....	....
AR-955 Models Trailer Air Suspension (Liftaxle) (AR-955-9, -12, -14, -17) 83000 Series	90044625	....	....	○	83125	....	....

# APPLICATION GUIDE

Year	Fitment Notes	OEM#					
			Fleetline	GasSLX	Fleetline	GasSLX	Cab Shock/ Specialty Shock

## SAF HOLLAND

## SAF HOLLAND

### TRAILER AIR SUSPENSION (cont)

AR-955 Models Trailer Air Suspension (Liftaxle) (AR-955-9HD, -12HD, -14HD, -17HD) 83000 Series	90044625	....	....	83125	....	....
AR-955 Models Trailer Air Suspension (Liftaxle) (AR-955A-9, -12, -14, -17) 83000 Series	90044625	....	....	83125	....	....
AR-955 Models Trailer Air Suspension (Liftaxle) (AR-955A-9HD, -12HD, -14HD, -17HD) 83000 Series	90044625	....	....	83125	....	....
ARA-93 Models Trailer Air Suspension (ARA-93-14) 85000 Series	90045054	....	....	85051	....	....
ARL20 Models Trailer Air Suspension (ARL20-D, ARL20-D-US) 83000 Series	90044162	....	....	83128	....	....
ARL20 Models Trailer Air Suspension (ARL20-D, ARL20-D-US) 89000 Series	90044162	....	....	....	89436	....
ARS112 Models Trailer Air Suspension (ARS112-6) 85000 Series	90045096	....	....	85916	....	....
ARS112 Models Trailer Air Suspension (ARS112-6) 89000 Series	90045096	....	....	....	89430	....
ARU-92 Models Trailer Air Suspension (ARU-92-8, -9, -10, -12) 83000 Series	90044642	....	....	83127	....	....
ARU-93 Models Trailer Air Suspension (ARU-93-6) 83000 Series	90045040	....	....	83130	....	....
ARU-93 Models Trailer Air Suspension (ARU-93-7, -8, -9, -10) 83000 Series	90044642	....	....	83127	....	....
ARU-98 Models Trailer Air Suspension (ARU-98-17) 85000 Series	90045054	....	....	85051	....	....
CB 25Y/CBX 25Y Models with Fusion Axle and Beam Assembly (10.0" Ride Height) 83000 Series	90044162	....	....	83128	....	....
CB 25Y/CBX 25Y Models with Fusion Axle and Beam Assembly (10.0" Ride Height) 89000 Series	90044162	....	....	....	89436	....
CB 25Y/CBX 25Y Models with Fusion Axle and Beam Assembly (12.0" Ride Height) 83000 Series	90045040	....	....	83130	....	....
CB 25Y/CBX 25Y Models with Fusion Axle and Beam Assembly (7.0" Ride Height) 85000 Series	90044868	....	....	85045	....	....
CB 25Y/CBX 25Y Models with Fusion Axle and Beam Assembly (8.0" Ride Height) 83000 Series	90045381	....	....	83150	....	....
CB 25Y/CBX 25Y Models with Fusion Axle and Beam Assembly (9.0" Ride Height) 83000 Series	90045608	....	....	83363	....	....
CB-2300 Models Trailer Air Suspension (16.0" & 17.0" Ride Height) 83000 Series	90045298	....	....	83363	....	....
CB-2300 Models Trailer Air Suspension (CB-2300-14) 85000 Series	90044868	....	....	85045	....	....
CB-2300 Models Trailer Air Suspension (CB-2300-15) 83000 Series	90045381	....	....	83150	....	....
CB-400/4000 Models Trailer Air Suspension 15.5" & 16.0" Ride Height (CB-400-15.5, CB-400-16.0) 83000 Series	90045298	....	....	83363	....	....
CB-400/4000 Models Trailer Air Suspension 16.5" & 17.0" Ride Height (CB-400-16.5, CB-400-17.0) 83000 Series	90044162	....	....	83128	....	....
CB-400/4000 Models Trailer Air Suspension 16.5" & 17.0" Ride Height (CB-400-16.5, CB-400-17.0) 89000 Series	90044162	....	....	....	89436	....
CB-400/4000 Models Trailer Air Suspension 18.0" Ride Height (CB-400-18.0) 83000 Series	90045040	....	....	83130	....	....
CBX 23 & CBX 25 Models Trailer Air Suspension (16.0" & 17.0" Ride Height) 83000 Series	90045298	....	....	83363	....	....
CBX 23 Fixed Frame Air Suspension with 14" Ride Height 83000 Series	90045381	....	....	83150	....	....
CBX 23 Models Trailer Air Suspension (CBX 23-14) 85000 Series	90044868	....	....	85045	....	....
CBX 23 Models Trailer Air Suspension (CBX 23-15) 83000 Series	90045381	....	....	83150	....	....
CBX 23 Models with 245 or 317 Fusion Axle and Beam Assembly For Bracket Type #1, 3, 4, & 5 - 15.0" Ride Height 83000 Series	90045608	....	....	83363	....	....
CBX 23 with 245 or 317 Fusion Axle and Beam Assembly For Bracket Type #1, 3, 4, & 5 - 16.0" & 17.0" Ride Height 83000 Series	90045299	....	....	83389	....	....
CBX 23 with 245 or 317 Fusion Axle and Beam Assembly For Bracket Type #1, 3, 4, & 5 - 16.0" & 17.0" Ride Height 89000 Series	90045299	....	....	....	89436	....
CBX 23U Fixed Frame Air Suspension with 10" Ride Height 83000 Series	90045040	....	....	83130	....	....
CBX 23U Fixed Frame Air Suspension with 6" Ride Height 85000 Series	90044868	....	....	85045	....	....
CBX 23U Models with 342 Fusion Axle and Beam Assembly (8.0" Ride Height) 83000 Series	90045608	....	....	83363	....	....
CBX 25 Fixed Frame Air Suspension with 14" Ride Height 83000 Series	90045381	....	....	83150	....	....
CBX 25 Fixed Frame Air Suspension with 16" Ride Height 83000 Series	90044162	....	....	83128	....	....

# APPLICATION GUIDE

Year	Fitment Notes	OEM#					
			Fleetline	GasSLX	Fleetline	GasSLX	Cab Shock\ Specialty Shock

## SAF HOLLAND

## SAF HOLLAND

### TRAILER AIR SUSPENSION (cont)

Description	OEM#	Fleetline	GasSLX	Fleetline	GasSLX	Cab Shock\ Specialty Shock
CBX 25 Models Trailer Air Suspension (CBX 25-14) 83000 Series	90045607	....	....	☉	83150	....
CBX 25 Models Trailer Air Suspension (CBX 25-16, CBX 25-17) 83000 Series	90045040	....	....	☉	83130	....
CBX 25 Models with 245 or 338 Fusion Axle and Beam Assembly (15.0" Ride Height) 83000 Series	90045608	....	....	☉	83363	....
CBX 25 with 245 Fusion Axle and Beam Assembly (16.0" & 17.0" Ride Height) 83000 Series	90045299	....	....	☉	83389	....
CBX 25 with 245 Fusion Axle and Beam Assembly (16.0" & 17.0" Ride Height) 89000 Series	90045299	....	....	☉	....	89436
CBX 25/30 Fixed Frame Air Suspension with 14" Ride Height 85000 Series	90044868	....	....	☉	85045	....
CBX 25/30 Fixed Frame Air Suspension with 16" Ride Height 83000 Series	90044162	....	....	☉	83128	....
CBX 25/30 Fixed Frame Air Suspension with 18" Ride Height 83000 Series	90045040	....	....	☉	83130	....
CBX 25/30 Fixed Frame Air Suspension with 19" Ride Height 85000 Series	90045053	....	....	☉	85908	....
CBX 25U Fixed Frame Air Suspension with 10" Ride Height 83000 Series	90044162	....	....	☉	83128	....
CBX 25U Fixed Frame Air Suspension with 12" Ride Height 83000 Series	90045040	....	....	☉	83130	....
CBX 25U Fixed Frame Air Suspension with 6" Ride Height 85000 Series	90044868	....	....	☉	85045	....
CBX 25U Fixed Frame Air Suspension with 8" Ride Height 83000 Series	90045381	....	....	☉	83150	....
CBX 25U-4 Models with 342 Fusion Axle and Beam Assembly (9.0" Ride Height) 83000 Series	90045608	....	....	☉	83363	....
CBX 30 Models with 245 or 338 Fusion Axle and Beam Assembly (15.0" Ride Height) 83000 Series	90045608	....	....	☉	83363	....
CBX 30 with 245 Fusion Axle and Beam Assembly (16.0" & 17.0" Ride Height) 83000 Series	90045299	....	....	☉	83389	....
CBX 30 with 245 Fusion Axle and Beam Assembly (16.0" & 17.0" Ride Height) 89000 Series	90045299	....	....	☉	....	89436
CBX 40 Models Trailer Air Suspension (CBX 40 -16.5, CBX 40 -17.0) 83000 Series	90044162	....	....	☉	83128	....
CBX 40 Models Trailer Air Suspension (CBX 40 -16.5, CBX 40 -17.0) 89000 Series	90044162	....	....	☉	....	89436
CBX 40 Models Trailer Air Suspension (CBX 40-18.0) 83000 Series	90045040	....	....	☉	83130	....
CBX 40 Models with 265 Fusion Axle and Beam Assembly (15.5" & 16.0" Ride Height) 83000 Series	90045298	....	....	☉	83363	....
CBX 46 Models Trailer Air Suspension (16" Ride Height) 83000 Series	90045298	....	....	☉	83363	....
CBX 46 Models Trailer Air Suspension (16.5" & 17.0" Ride Height) 83000 Series	90044162	....	....	☉	83128	....
CBX 46 Models Trailer Air Suspension (16.5" & 17.0" Ride Height) 89000 Series	90044162	....	....	☉	....	89436
CBX 50 Models Trailer Air Suspension (16" Ride Height) 83000 Series	90045298	....	....	☉	83363	....
CBX 50 Models Trailer Air Suspension (16.5" & 17.0" Ride Height) 83000 Series	90044162	....	....	☉	83128	....
CBX 50 Models Trailer Air Suspension (16.5" & 17.0" Ride Height) 89000 Series	90044162	....	....	☉	....	89436
CBX 69 Trailer Air Suspension 83000 Series	90045669	....	....	☉	83389	....
CBX 69 Trailer Air Suspension 89000 Series	90045669	....	....	☉	....	89436
CBXA 40 Aerobeam Slider Air Suspension with 16" Ride Height 83000 Series	90045298	....	....	☉	83363	....
CBXA 40 Aerobeam Slider Air Suspension with 16.5" - 17" Ride Height 83000 Series	90044162	....	....	☉	83128	....
CBXA 40 Aerobeam Slider Air Suspension with 16.5" - 17" Ride Height 89000 Series	90044162	....	....	☉	....	89436
CBXA 40 Aerobeam Slider Air Suspension with 18" Ride Height 83000 Series	90045040	....	....	☉	83130	....
CBXAN 23 Aerobeam Fixed Frame Air Suspension with 14" Ride Height 85000 Series	90044868	....	....	☉	85045	....
CBXAN 23 Aerobeam Fixed Frame Air Suspension with 15" Ride Height 83000 Series	90045381	....	....	☉	83150	....
CBXAN 23 Aerobeam Fixed Frame Air Suspension with 16" Ride Height 83000 Series	90044162	....	....	☉	83128	....

# APPLICATION GUIDE

Year	Fitment Notes	OEM#					
			Fleetline	GasSLX	Fleetline	GasSLX	Cab Shock/ Specialty Shock

## SAF HOLLAND

## SAF HOLLAND

### TRAILER AIR SUSPENSION (cont)

CBXAN 23 Aerobeam Fixed Frame Air Suspension with 17" Ride Height 83000 Series	90045299	....	....	83389	....	....
CBXAN 23 Aerobeam Fixed Frame Air Suspension with 17" Ride Height 89000 Series	90045299	....	....	....	89436	....
CBXAS 23 Aerobeam Fixed Frame Air Suspension with 14" Ride Height 85000 Series	90044868	....	....	85045	....	....
CBXAS 23 Aerobeam Fixed Frame Air Suspension with 15" Ride Height 83000 Series	90045607	....	....	83150	....	....
CBXAS 23 Aerobeam Fixed Frame Air Suspension with 17" Ride Height 83000 Series	90045669	....	....	83389	....	....
CBXAS 23 Aerobeam Fixed Frame Air Suspension with 17" Ride Height 89000 Series	90045669	....	....	....	89436	....
CBXAS 25 Aerobeam Fixed Frame Air Suspension with 14" Ride Height 85000 Series	90044868	....	....	85045	....	....
CBXAS 25 Aerobeam Fixed Frame Air Suspension with 15" Ride Height 83000 Series	90045607	....	....	83150	....	....
CBXAS 25 Aerobeam Fixed Frame Air Suspension with 17" Ride Height 83000 Series	90045669	....	....	83389	....	....
CBXAS 25 Aerobeam Fixed Frame Air Suspension with 17" Ride Height 89000 Series	90045669	....	....	....	89436	....
CBXAS 30 Aerobeam Fixed Frame Air Suspension with 14" Ride Height 85000 Series	90044868	....	....	85045	....	....
CBXAS 30 Aerobeam Fixed Frame Air Suspension with 15" Ride Height 83000 Series	90045607	....	....	83150	....	....
CBXAS 30 Aerobeam Fixed Frame Air Suspension with 17" Ride Height 83000 Series	90045299	....	....	83389	....	....
CBXAS 30 Aerobeam Fixed Frame Air Suspension with 17" Ride Height 89000 Series	90045299	....	....	....	89436	....
Models with O.E.M. Number (Hvy Duty) 85000 Series	90045666	....	....	85051	....	....
Models with O.E.M. Number (STD) 83000 Series	90045666	....	....	83130	....	....
Models with O.E.M. Number 83000 Series	XBSPN05336 XB-SPN-053-36	....	....	83125	....	....
	90045564	....	....	83128	....	....
	90045574	....	....	83130	....	....
	90045576	....	....	83150	....	....
Models with O.E.M. Number 85000 Series	90045563	....	....	85014	....	....
	90045665	....	....	85029	....	....
	90045572	....	....	85045	....	....
	90045575	....	....	85051	....	....
	90045667	....	....	85060	....	....
	90045003 90045001	....	....	85323	....	....
	90045002 90045000	....	....	85906	....	....
	90045188 90045083	....	....	85910	....	....
90045433	....	....	85916	....	....	
Models with O.E.M. Number 89000 Series	90045207	....	....	....	89405	....
	90045002 90045000	....	....	....	89407	....
	90045433	....	....	....	89430	....
	90045003 90045564 90045001	....	....	....	89436	....
	90045003 90045564 90045001	....	....	....	89436	....
NL-200 Models Non Steer - Auxiliary Lift Air Suspension (NL-200-1S, NL-200-2S) 83000 Series	90044162	....	....	83128	....	....
NL-200 Models Non Steer - Auxiliary Lift Air Suspension (NL-200-1S, NL-200-2S) 89000 Series	90044162	....	....	....	89436	....
NS-190 Models Trailer Air Suspension (NS-190-16.0) 83000 Series	90044162	....	....	83128	....	....
NS-190 Models Trailer Air Suspension (NS-190-16.0) 89000 Series	90044162	....	....	....	89436	....





# APPLICATION GUIDE

Year	Fitment Notes	OEM#					
				Fleetline	GasSLX		Fleetline





## SAF HOLLAND

## SAF HOLLAND

### TRAILER AIR SUSPENSION (cont)

RL-250 Models Trailer Air Suspension (Shock Below Frame) (RL-250-16-4, -17-4) 89000 Series	90045299	....	....		89436	....
RL-250 Models Trailer Air Suspension (Std Suspension) (RL-250-12) 85000 Series	90045054	....	....		85051	....
RL-250 Models Trailer Air Suspension (Std Suspension) (RL-250-14.0, -15.0) 83000 Series	90044642	....	....		83127	....
RL-250 Models Trailer Air Suspension (Std Suspension) (RL-250-16.0, -17.0) 83000 Series	90044089	....	....		83124	....
RL-250 Models Trailer Air Suspension (Std Suspension) (RL-250-16.0, -17.0) 89000 Series	90044089	....	....		89407	....
RL-300 Models Trailer Air Suspension (Offset Stud Air Spring) (RL-300-13) 85000 Series	90045054	....	....		85051	....
RL-300 Models Trailer Air Suspension (Offset Stud Air Spring) (RL-300-14, -15, -16, -17) 85000 Series	90045338	....	....		85060	....
RL-300 Models Trailer Air Suspension (Std Suspension) (RL-300-12, -13) 85000 Series	90045054	....	....		85051	....
RL-300 Models Trailer Air Suspension (Std Suspension) (RL-300-14, -15, -16, -17) 85000 Series	90045338	....	....		85060	....
RLSA Models Trailer Air Suspension (RLSA-4214, -4215, -4814, -4815) 85000 Series	90044978	....	....		85059	....
RLSA Models Trailer Air Suspension (RLSA-4216, -4217, -4816, -4817) 83000 Series	90044979	....	....		83113	....
RLSA228 Models Trailer Air Suspension (RLSA-228-4214, -4215, -4216, -4814, -4815, -4816) 83000 Series	90044642	....	....		83127	....
RLSA228 Models Trailer Air Suspension (RLSA-228-4217, -4817) 83000 Series	90044089	....	....		83124	....
RLSA228 Models Trailer Air Suspension (RLSA-228-4217, -4817) 89000 Series	90044089	....	....		89407	....
RLU-228 Models Trailer Air Suspension (Axle Mounted Shock Suspension) (RLU-228-8-3) 83000 Series	90044162	....	....		83128	....
RLU-228 Models Trailer Air Suspension (Axle Mounted Shock Suspension) (RLU-228-8-3) 89000 Series	90044162	....	....		89436	....
RLU-228 Models Trailer Air Suspension (Axle Mounted Shock Suspension) (RLU-228-9-3, RLU-228-10-3, RLU-228-12-3) 83000 Series	90044642	....	....		83127	....
RLU-228 Models Trailer Air Suspension (Current Production - w/3" Axle Travel Up) (RLU-228-10-3, RLU-228-12-3) 83000 Series	90044642	....	....		83127	....
RLU-228 Models Trailer Air Suspension (Current Production - w/3" Axle Travel Up) (RLU-228-6-3) 83000 Series	90045298	....	....		83363	....
RLU-228 Models Trailer Air Suspension (Current Production - w/3" Axle Travel Up) (RLU-228-7-3) 83000 Series	90044162	....	....		83128	....
RLU-228 Models Trailer Air Suspension (Current Production - w/3" Axle Travel Up) (RLU-228-7-3) 89000 Series	90044162	....	....		89436	....
RLU-228 Models Trailer Air Suspension (Current Production - w/3" Axle Travel Up) (RLU-228-8-3) 83000 Series	90045040	....	....		83130	....
RLU-228 Models Trailer Air Suspension (Current Production - w/3" Axle Travel Up) (RLU-228-9-3) 85000 Series	90045054	....	....		85051	....
RLU-228 Models Trailer Air Suspension (Current Production - w/4" Axle Travel Up) (RLU-228-10-4) 83000 Series	90044642	....	....		83127	....
RLU-228 Models Trailer Air Suspension (Current Production - w/4" Axle Travel Up) (RLU-228-8-4) 83000 Series	90044162	....	....		83128	....
RLU-228 Models Trailer Air Suspension (Current Production - w/4" Axle Travel Up) (RLU-228-8-4) 89000 Series	90044162	....	....		89436	....
RLU-228 Models Trailer Air Suspension (Current Production - w/4" Axle Travel Up) (RLU-228-9-4, RLU-228-12-4) 83000 Series	90044626	....	....		83126	....
RLU-228 Models Trailer Air Suspension (Current Production - w/4" Axle Travel Up) (RLU-228-9-4, RLU-228-12-4) 89000 Series	90044626	....	....		89430	....
RLU-228 Models Trailer Air Suspension (Current Production - w/4" Axle Travel Up) HVY DTY (RLU-228-8-4) 85000 Series	90045337	....	....		85911	....
RLU-228 Models Trailer Air Suspension (RLU-228-10-3) 83000 Series	90044089	....	....		83124	....
RLU-228 Models Trailer Air Suspension (RLU-228-10-3) 89000 Series	90044089	....	....		89407	....
RLU-228 Models Trailer Air Suspension (RLU-228-6-3) 83000 Series	90045040	....	....		83130	....
RLU-228 Models Trailer Air Suspension (RLU-228-7-3) 83000 Series	90044642	....	....		83127	....
RLU-228 Models Trailer Air Suspension (RLU-228-8-3, RLU-228-9-3) 83000 Series	90044626	....	....		83126	....
RLU-228 Models Trailer Air Suspension (RLU-228-8-3, RLU-228-9-3) 89000 Series	90044626	....	....		89430	....

# APPLICATION GUIDE

Year	Fitment Notes	OEM#					
			 Fleetline	GasSLX	 Fleetline	GasSLX	Cab Shock\ Specialty Shock

## SAF HOLLAND

## SAF HOLLAND

### TRAILER AIR SUSPENSION (cont)

RLU-250 Models Trailer Air Suspension (Frame Mount Suspension) (RLU-250-12-FMT) 85000 Series	90045054	....	....	○	85051	....	....
RLU-250 Models Trailer Air Suspension (Frame Mount Suspension) (RLU-250-6.5-FMT) 83000 Series	90045381	....	....	○	83150	....	....
RLU-250 Models Trailer Air Suspension (Frame Mount Suspension) (RLU-250-9-FMT) 83000 Series	90044162	....	....	○	83128	....	....
RLU-250 Models Trailer Air Suspension (Frame Mount Suspension) (RLU-250-9-FMT) 89000 Series	90044162	....	....	○	....	89436	....
RLU-250 Models Trailer Air Suspension (RLU-250-12) 83000 Series	90044642	....	....	○	83127	....	....
RLU-250 Models Trailer Air Suspension (RLU-250-6.5) 83000 Series	90045381	....	....	○	83150	....	....
RLU-250 Models Trailer Air Suspension (RLU-250-9) 83000 Series	90044162	....	....	○	83128	....	....
RLU-250 Models Trailer Air Suspension (RLU-250-9) 89000 Series	90044162	....	....	○	....	89436	....
RLU-300 Models Trailer Air Suspension (Std Suspension) (RLU-300-6.5) 83000 Series	90045381	....	....	○	83150	....	....
RLU-300 Models Trailer Air Suspension (Std Suspension) (RLU-300-9) 85000 Series	90045337	....	....	○	85911	....	....
Trailer Air Suspension (RL196-16,-17) 83000 Series	90044979	....	....	○	83113	....	....

### TRUCK & TRACTOR AIR SUSPENSION (TAG AXLE)

Models with O.E.M. Number 83000 Series	90044683 6025 90044679 90044688	....	....	○	83122	....	....	
	AR-2598	....	....	○	83123	....	....	
	90044684 90044089C	....	....	○	83124	....	....	
	90044687 90044680	....	....	○	83125	....	....	
	90044915	....	....	○	83127	....	....	
	90045110	....	....	○	83137	....	....	
	AR-1434 AR-781 90044095 AR-718-C AR-2451	....	....	○	83203	....	....	
	6026 AR-1141 90044681 AR-1141-C	....	....	○	83204	....	....	
	AR-958 90044770	....	....	○	83207	....	....	
	AR-1654 90044682	....	....	○	83209	....	....	
	90044685	....	....	○	83389	....	....	
	90044878	....	....	○	83635	....	....	
	Models with O.E.M. Number 85000 Series	90044982 90044981 90044991 AR-718-C-HD 90044071 90044081 57639 90044086	....	....	○	85000	....	....
		90044001 AR-134-C	....	....	○	85005	....	....
		AR-1008	....	....	○	85006	....	....
57643		....	....	○	85013	....	....	
90044686		....	....	○	85051	....	....	
90044833 90044834		....	....	○	85052	....	....	
AR-1202		....	....	○	85300	....	....	
AR-1404 AR-1425		....	....	○	85301	....	....	



# APPLICATION GUIDE

Year	Fitment Notes	OEM#					
			 Fleetline	 GasSLX	 Fleetline	 GasSLX	 Cab Shock Specialty Shock

## SAF HOLLAND

## SAF HOLLAND

### TRUCK & TRACTOR AIR SUSPENSION (TAG AXLE) (cont)

Models with O.E.M. Number 85000 Series	AR-1822	....	....	○	85304	....	....
	AR-995	....	....	○	85734	....	....
Models with O.E.M. Number 89000 Series	90045175 90045384	....	....	○	85916	....	....
	AR-2598	....	....	○	....	89405	....
	90044683 6025 90044679 90044688	....	....	○	....	89406	....
	90044684 AR-958 90044089C 90044770	....	....	○	....	89407	....
	AR-1654 57643 90044682	....	....	○	....	89414	....
	AR-1202	....	....	○	....	89419	....
	90044001 AR-134-C 90045175 90045384	....	....	○	....	89430	....
	AR-718-C-HD AR-718-C AR-2451 90044685 90044982 90044981 90044991 AR-1434 AR-781 90044095 90044071 90044081 57639 90044086	....	....	○	....	89436	....

### TRUCK, BUS & MOTORHOME AIR SUSPENSIONS

AD-123 Models Truck and Tractor Air Suspension (AD123-6,-8,-10,-8.75) Shock Mount approx. 2-1/2" above bottom of frame 85000 Series	90045132	....	....	○	85909	....	....
AD-123 Models Truck and Tractor Air Suspension (AD123-6,-8,-10,-8.75) Shock Mount flush with bottom of frame 85000 Series	90045099	....	....	○	85906	....	....
AD-123 Models Truck and Tractor Air Suspension (AD123-6,-8,-10,-8.75) Shock Mount flush with bottom of frame 89000 Series	90045099	....	....	○	....	89407	....
AD-130 Models Truck and Tractor Air Suspension (AD123-6,-8,-10,-8.75) 89000 Series	90045466	....	....	○	....	89406	....
AD-130 Models Truck and Tractor Air Suspension W/ OEM Number 85000 Series	90045432	....	....	○	85321	....	....
AD-150 Models Truck & Tractor Air Suspension 85000 Series	90045075	....	....	○	85911	....	....
AD-200 Models Truck & Tractor Air Suspension (AD-200-7, -8, -9, -11) 85000 Series	90045138	....	....	○	85910	....	....
AD-246 Models Truck & Tractor Air Suspension (AD246 -6, -8, -10, -8.75) 85000 Series	90045099	....	....	○	85906	....	....
	90045132	....	....	○	85909	....	....
AD-246 Models Truck & Tractor Air Suspension (AD246 -6, -8, -10, -8.75) 89000 Series	90045099	....	....	○	....	89407	....
AD-252-10 Tandem Axle 85000 Series	90045132	....	....	○	85909	....	....
ARD-120 Models Truck & Tractor Air Suspension (ARD-120-6) 83000 Series	90044025	....	....	○	83209	....	....
ARD-120 Models Truck & Tractor Air Suspension (ARD-120-6) 89000 Series	90044025	....	....	○	....	89414	....
ARD-125 Models Truck & Tractor Air Suspension (ARD-125-6 use on Ford, GM, International (Navistar), Mack, White, Western Star, Freightliner) 83000 Series	90044025	....	....	○	83209	....	....
ARD-125 Models Truck & Tractor Air Suspension (ARD-125-6 use on Ford, GM, International (Navistar), Mack, White, Western Star, Freightliner) 89000 Series	90044025	....	....	○	....	89414	....
ARD-125 Models Truck & Tractor Air Suspension (ARD-125-8 use on Freightliner, White, Western Star) 85000 Series	90044011	....	....	○	85004	....	....
ARD-125 Models Truck & Tractor Air Suspension (ARD-125-8 use on Mack) 85000 Series	90044016	....	....	○	85300	....	....

# APPLICATION GUIDE

Year	Fitment Notes	OEM#					
			Fleetline	GasSLX	Fleetline	GasSLX	Cab Shock\ Specialty Shock

## SAF HOLLAND

## SAF HOLLAND

### TRUCK, BUS & MOTORHOME AIR SUSPENSIONS (cont)

ARD-125 Models Truck & Tractor Air Suspension (ARD-125-8 use on Mack) 89000 Series	90044016	....	....	O	....	89419	....
ARD-165 Models Truck & Tractor Air Suspension (ARD-165-A, ARD-165-B) 85000 Series	90044011	....	....	O	85004	....	....
ARD-190 Models Truck & Tractor Air Suspension (ARD-190-B) 85000 Series	90044016	....	....	O	85300	....	....
ARD-190 Models Truck & Tractor Air Suspension (ARD-190-B) 89000 Series	90044016	....	....	O	....	89419	....
ARD-234 Models Truck & Tractor Air Suspension (ARD-234-6) 83000 Series	90044046	....	....	O	83123	....	....
ARD-234 Models Truck & Tractor Air Suspension (ARD-234-6) 89000 Series	90044046	....	....	O	....	89405	....
ARD-238 Models Truck & Tractor Air Suspension (ARD-238-6) 83000 Series	90044025	....	....	O	83209	....	....
ARD-238 Models Truck & Tractor Air Suspension (ARD-238-6) 89000 Series	90044025	....	....	O	....	89414	....
ARD-244 Models Truck & Tractor Air Suspension (ARD-244-6 use on Ford, GM, International (Navistar), Mack, White, Western Star, Freightliner) 83000 Series	90044025	....	....	O	83209	....	....
ARD-244 Models Truck & Tractor Air Suspension (ARD-244-6 use on Ford, GM, International (Navistar), Mack, White, Western Star, Freightliner) 89000 Series	90044025	....	....	O	....	89414	....
ARD-244 Models Truck & Tractor Air Suspension (ARD-244-8 use on Freightliner, White, Western Star) 85000 Series	90044011	....	....	O	85004	....	....
ARD-244 Models Truck & Tractor Air Suspension (ARD-244-8 use on Mack) 85000 Series	90044016	....	....	O	85300	....	....
ARD-244 Models Truck & Tractor Air Suspension (ARD-244-8 use on Mack) 89000 Series	90044016	....	....	O	....	89419	....
ARDAB-120 Models Truck & Tractor Air Suspension (ARDAB-120-5) 83000 Series	90044907	....	....	O	83635	....	....
ARDAB-238-5 Models Truck & Tractor Air Suspension 83000 Series	90044907	....	....	O	83635	....	....
ARDAB-240 Models Truck & Tractor Air Suspension (ARDAB-240-5) 83000 Series	90044907	....	....	O	83635	....	....
ARDST-123 Models Truck & Tractor Air Suspension (ARDST-123-6, ARDSTML-123-6) 83000 Series	90044025	....	....	O	83209	....	....
ARDST-123 Models Truck & Tractor Air Suspension (ARDST-123-6, ARDSTML-123-6) 89000 Series	90044025	....	....	O	....	89414	....
ARDST-244 Models Truck & Tractor Air Suspension (ARDST-244-6) 83000 Series	90044025	....	....	O	83209	....	....
ARDST-244 Models Truck & Tractor Air Suspension (ARDST-244-6) 89000 Series	90044025	....	....	O	....	89414	....
ARDST-246 Models Truck & Tractor Air Suspension (ARDST-246-6, ARDSTML-246-6) 83000 Series	90044025	....	....	O	83209	....	....
ARDST-246 Models Truck & Tractor Air Suspension (ARDST-246-6, ARDSTML-246-6) 89000 Series	90044025	....	....	O	....	89414	....
ARDST-250-6 Models Truck & Tractor Air Suspension 83000 Series	90044025	....	....	O	83209	....	....
ARDST-250-6 Models Truck & Tractor Air Suspension 89000 Series	90044025	....	....	O	....	89414	....
ARDTB-125 Models Bus Air Suspension (ARDTB-125-6A) 85000 Series	90044448	....	....	O	85051	....	....
ARDTB-125-6A (Note: Rear shock) 85000 Series	90045053	....	....	O	85908	....	....
ART-500 Models Truck & Tractor Tag Axle Air Suspension (ART-500-B, ART-500-B-1) 83000 Series	90044162	....	....	O	83128	....	....
ART-500 Models Truck & Tractor Tag Axle Air Suspension (ART-500-B, ART-500-B-1) 89000 Series	90044162	....	....	O	....	89436	....
ART-500 Models Truck & Tractor Tag Axle Air Suspension (ART-500-US, ART-500-US-A) 85000 Series	90044008	....	....	O	85000	....	....
ART-500 Models Truck & Tractor Tag Axle Air Suspension (ART-500-US, ART-500-US-A) 89000 Series	90044008	....	....	O	....	89436	....
ART-505 Models Truck & Tractor Tag Axle Air Suspension (ART-505-B, -1, ART-505-C, -1) 83000 Series	90044162	....	....	O	83128	....	....
ART-505 Models Truck & Tractor Tag Axle Air Suspension (ART-505-B, -1, ART-505-C, -1) 89000 Series	90044162	....	....	O	....	89436	....
ART-541 Models Truck & Tractor Tag Axle Air Suspension (ART-541B) 83000 Series	90044162	....	....	O	83128	....	....
ART-541 Models Truck & Tractor Tag Axle Air Suspension (ART-541B) 89000 Series	90044162	....	....	O	....	89436	....
ART-550 Models Truck & Tractor Tag Axle Air Suspension (ART-550-US-1, -2, -3) 85000 Series	90044012	....	....	O	85006	....	....

# APPLICATION GUIDE

Year	Fitment Notes	OEM#					
			Fleetline	GasSLX	Fleetline	GasSLX	Cab Shock Specialty Shock

## SAF HOLLAND

## SAF HOLLAND



### TRUCK, BUS & MOTORHOME AIR SUSPENSIONS (cont)

	ART-551 Models Truck & Tractor Tag Axle Air Suspension (ART-551-B-1) 83000 Series	90044162	....	....	⊙	83128	....	....
	ART-551 Models Truck & Tractor Tag Axle Air Suspension (ART-551-B-1) 89000 Series	90044162	....	....	⊙	....	89436	....
	ART-551 Models Truck & Tractor Tag Axle Air Suspension (ART-551-B-2, -3, ART-551-US-1, -2, -3) 83000 Series	90044017	....	....	⊙	83204	....	....
	ART-555 Models Truck & Tractor Tag Axle Air Suspension (ART-555-B-1, ART-555-C-1) 83000 Series	90044162	....	....	⊙	83128	....	....
	ART-555 Models Truck & Tractor Tag Axle Air Suspension (ART-555-B-1, ART-555-C-1) 89000 Series	90044162	....	....	⊙	....	89436	....
	ART-555 Models Truck & Tractor Tag Axle Air Suspension (ART-555-B-2, -3, ART555C-2, -3) 83000 Series	90044642	....	....	⊙	83127	....	....
	Models with Neway AS140 w/ 14,000 lb Front Suspension 85000 Series	90045455	....	....	⊙	85909	....	....
	Models with O.E.M. Number 85000 Series	90045336	....	....	⊙	85014	....	....
		90045534	....	....	⊙	....	....	....
		471700000458	....	....	⊙	85030	....	....
		471700000459	....	....	⊙	....	....	....
		471700000436	....	....	⊙	....	....	....
	90045504	....	....	⊙	85060	....	....	
	90045277	....	....	⊙	85916	....	....	
	90045532	....	....	⊙	....	....	....	
90045568	....	....	⊙	85060	....	....		
90045418	....	....	⊙	85916	....	....		
Models with O.E.M. Number 89000 Series	90045419	....	....	⊙	....	89405	....	
	90045536	....	....	⊙	....	89414	....	
	471700000461	....	....	⊙	....	89430	....	
	90045503	....	....	⊙	....	89430	....	
	90045500	....	....	⊙	....	89430	....	
481700000485	....	....	⊙	....	89440	....		
90045418	....	....	⊙	....	89440	....		
481700000483	....	....	⊙	....	89440	....		
471700000459	....	....	⊙	....	89440	....		
471700000436	....	....	⊙	....	89440	....		
90045504	....	....	⊙	....	89440	....		
90045277	....	....	⊙	....	89440	....		
90045420	....	....	⊙	....	89440	....		
90045532	....	....	⊙	....	89440	....		
10-23	ADZ-123 Models Truck and Bus Air Suspension 85000 Series	90045812 90045605 90045803	....	....	⊙	85109	....	....
	ADZ-126 Models Truck and Bus Air Suspension 85000 Series	90045812 90045605 90045803	....	....	⊙	85109	....	....
	ADZ-246 Models Truck and Bus Air Suspension 85000 Series	90045812 90045605 90045803	....	....	⊙	85109	....	....
	ADZ-252 Models Truck and Bus Air Suspension 85000 Series	90045812 90045605 90045803	....	....	⊙	85109	....	....
	ADZ-369 Models Truck and Bus Air Suspension 85000 Series	90045812 90045605 90045803	....	....	⊙	85109	....	....
	ADZ-378 Models Truck and Bus Air Suspension 85000 Series	90045812 90045605 90045803	....	....	⊙	85109	....	....
00-21	AD-246 Models with 10" Ride Height 85000 Series	90045504	....	....	⊙	85030	....	....
	AD-246 Models with 10" Ride Height 89000 Series	90045504	....	....	⊙	....	89440	....
	AD-369 Models with 10" Ride Height 85000 Series	90045504	....	....	⊙	85030	....	....
	AD-369 Models with 10" Ride Height 89000 Series	90045504	....	....	⊙	....	89440	....

### VARIOUS

	Self - Steering Axle Shocks Specialty Shock	90045331	⊙	646155
		646201	⊙	646177
		632155	⊙	646177





















# APPLICATION GUIDE

Year	Fitment Notes	OEM#					
			Fleetline	GasSLX	Fleetline	GasSLX	Cab Shock\ Specialty Shock

## SAFARI MOTOR COACH

## SAFARI MOTOR COACH









### CLASS A MOTORHOMES

96-00	Magnum Air B Series (Air-Ride) (4 Units Req'd Front & Rear) 83000 Series	B46-2092			83126	....	....	....			
		....			....	....			83126	....	....
	Magnum Air B Series (Air-Ride) (4 Units Req'd Front & Rear) 89000 Series	B46-2092			....	89430	....	....			
		....			....	....			....	89430	....
95-00	Magnum Blue Max M Series w/ Velvet Ride Torsion 85000 Series	B46-2092			85910	....	....	....			
		B46-2093			....	....			85058	....	....
	Magnum Blue Max M Series w/ Velvet Ride Torsion 89000 Series	B46-2093			....	....			....	89431	....
93-99	Magnum Bluestreak Leaf Spring 85000 Series	B46-2092			85910	....	....	....			
		B46-2093			....	....			85058	....	....
	Magnum Bluestreak Leaf Spring 89000 Series	B46-2093			....	....			....	89431	....

## SCANIA

## SCANIA







### MARCO POLO

02-07	All	510006			....	....			85705	....	....
98-03	Type 1150 with Scania body	510006			85705	....			85705	....	....
96-01	All	510006			85705	....			85705	....	....

## SEAGRAVE FIRE APPARATUS LLC



## SEAGRAVE FIRE APPARATUS LLC

### VARIOUS

	Models with Marauder II chassis 85000 Series	P2598000			85712	....	....	....			
	Models with O.E.M. Number 85000 Series	680117 P0025500			....	....			85300	....	....
	Models with O.E.M. Number 89000 Series	680117 P0025500			....	....			....	89419	....



## SICARD

## SICARD

	Models with O.E.M. Number 85000 Series	3166657			85700	....	....	....
--	--	---------	---	---	-------	------	------	------

## SOUTHERN COACH



## SOUTHERN COACH

	Early Model Air Suspension 85000 Series	....			85304	....	....	....
--	---	------	---	---	-------	------	------	------



## SPARTAN MOTORS

## SPARTAN MOTORS





### ALPINE

97-00	MotorHome Chassis with O.E.M. Number	1300B46 0377-SS5 B46-1725			....	....			85029	....	....
-------	--------------------------------------	---------------------------------	--	--	------	------	---	---	-------	------	------











### CLASS A MOTORHOMES

00-12	Summit (19000 - 22000 GVW) 85000 Series	B46-1725			85910	....	....	....
-------	---	----------	---	---	-------	------	------	------





### HIGHLANDER

97-00	With I Beam Front Suspension	B46-1731 B46-2150			85909	....	....	....	
		B46-1732 B46-2151			....	....			85030

### K2





97-00	Models with O.E.M. Number	2200201 B46-2151			....	....			85007	....	....
		B46-1731 B46-2150			85909	....	....	....	....		
	With I Beam Front Suspension	B46-1732 B46-2151			....	....			85030	89440	....
		B46-2385			....	....			85030	....	....
	With Independent Front Granning Suspension	B46-2385			....	....			....	89440	....

# APPLICATION GUIDE

Year	Fitment Notes	OEM#					
			 Fleetline	GasSLX	 Fleetline	GasSLX	Cab Shock Specialty Shock

## SPARTAN MOTORS

### K2 (cont)







97-00	With Independent Front Granning Suspension	B46-2151	....	....		85030	89440	....
95-96	Models with I Beam Front Suspension 85000 Series	B46-1731 B46-2150		85909	....	....	....	....
		B46-1732 B46-2151	....	....	....		85030	....
91-95	Models with Tuthill 102 AR Air Suspension 85000 Series	B46-1732 B46-2151	....	....	....	....	89440	....
		B46-1594 B46-2502 0346-SS5	....	....	....		85030	....
91-95	Models with Tuthill 102 AR Air Suspension 89000 Series	B46-1594 B46-2502 0346-SS5	....	....	....	....	89440	....
		....	....	....	....		....	....

## SPARTAN MOTORS

### MOTORHOME

91-92	Models with Tuthill 102 AR Air Suspension	B46-1594 B46-2502 0346-SS5	....	....	....		85013	89414	....
-------	---	----------------------------------	------	------	------	---	-------	-------	------











### MOUNTAIN MASTER

97-00	Models with O.E.M. Number	2200201 B46-2151	....	....	....		85007	....	....
	With Independent Front Granning Suspension	B462385	....	....	....		85030	....	....
		B46-2385	....	....	....		....	89440	....
		B46-2151	....	....	....		85030	89440	....
95-00	With I Beam Front Suspension	B46-1731 B46-2150		85909	....	....	....	....	
		B46-1732 B46-2151	....	....	....		85030	89440	....
93-95	Models with Tuthill 102 AR Air Suspension	B46-1594 B46-2502 0346-SS5	....	....	....		85013	89414	....

### RV MODELS



	RV Models with Primaax Air Suspensions 85000 Series	60665-014 60665-014L	....	....	....		85962	....	....
--	---	-------------------------	------	------	------	---	-------	------	------

### VARIOUS

	Buses with Hendrickson Softek Suspension with Drum and Disc Brakes 85000 Series	58913-009L 58913-009 47170000456		85959	....	....	....	....	
	Chassis With Hendrickson HTS 210 Suspension (Type C School Bus Applications) 85000 Series	60665-025 60665-025L	....	....	....		85036	....	....
	Chassis With Hendrickson HTS 210 Suspension (Type C School Bus Applications) 89000 Series	60665-025 60665-025L	....	....	....		....	89405	....
	Fire Truck with O.E.M. Number 85000 Series	0272-SS5		85712	....	....	....	....	
	Fire Truck with Ridewell Suspension RD 202 52000 85000 Series	S2607B	....	....	....		85702	....	....
	Models with O.E.M. Number 83000 Series	59011		83214	....	....	....	....	
	Models with Reyco 1200 Steer Option) 85000 Series	21310-01		85307	....	....	....	....	
97-00	Summit MotorHome Chassis with O.E.M. Number 85000 Series	1300B46 0377-SS5 B46-1725	....	....	....		85029	....	....
		AS4025B		85712	....	....	....	....	
86	Fire Truck with Ridewell Front Suspension 85000 Series	AS4025B		85712	....	....	....	....	

## SPRING VALLEY

## SPRING VALLEY

	SS120 Steering Stabilizer Specialty Shock	632155		....	....	....	646177	....
	SS130L Steering Stabilizer Specialty Shock	632155		....	....	....	646177	....

# APPLICATION GUIDE

Year	Fitment Notes	OEM#					
			Fleetline	GasSLX	Fleetline	GasSLX	Cab Shock\ Specialty Shock

## STARCRAFT BUS CO.

## STARCRAFT BUS CO.

### ALLSTAR XL & XLT - SERIES

15-23	Models with F-650 chassis with 13,500, 15,500 & 19,000 lb Multi-leaf Rear Springs From 07/15 85000 Series	FC4Z-18125-A ASH-24660 471700011531 FC44-18080-AB	OIO	85180	....	....	....
	Models with F-650 chassis with 19.5" or 22.5" Wheels (22,000 lb GVW) From 07/15 85000 Series	FC4Z-18124-B FC4Z-18124-A ASH-24659 ASH-24658 471700011530 FC44-18045-BB	OIO	85181	....	....	....
00-15	Models with F-650 chassis with 10,000 lb Front Suspension 83000 Series	3584116C1 3584116C2 AA-616 4C4Z-18124-QA	OIO	83175	....	....	....
	Models with F-650 chassis with 12,000 & 13,200 lb Front Springs 85000 Series	4C4Z-18124-JB 3584118C2 AA-617 4C4Z-18124-RA AT-812	OIO	85928	....	....	....
15	Models with F-650 chassis with 21,000 lb Rear Air Suspension To 2015 85000 Series	3578858C1 3578858C2 4C4Z-18125-DA	OIO	85656	....	....	....
04-11	Models with F-650 chassis with 22,000 lb Multi-leaf Rear Springs 83000 Series	4C4Z-18125-B 501906C92 ASH-24661	OIO	83317	....	....	....

## STERLING TRUCK

## STERLING TRUCK

### A - LINE 9500 SERIES (SILVERSTAR)

98-09	A9513, A9522, AT9513, AT9522 (113" & 122" BBC) Models with 8500, 9000 or 10000 lb Axle and 54" Multileaf Spring 89000 Series	F6HT-18045-KA	OIO	....	89402	....	....	....
-------	--	---------------	-----	------	-------	------	------	------

### A9500

99-10	All Models with 12000 lb, 13200 lb or 14600 lb Axle and 60" Taperleaf Spring	F6HT-18045-EB F6HT-18045-EC	OIO	85055	89439	....	....	....
	All Models with 23000 lb Axle and 52" Taperleaf Softride Rear Suspension	F6HT-18080-CA	OIO	....	....	85314	89425	....
	All with 13200 lb or 14600 lb Axle and 54" Taperleaf Spring	F6HT-18045-GC	OIO	85030	89440	....	....	....
	Models with 10000 lb or 12000 lb Axle and 54" Taperleaf Spring	F6HT-18045-AC	OIO	85054	....	....	....	....
	Models with 12000 or 13200 lb Axle and 54" Multileaf Spring	F6HT-18045-BC	OIO	85047	89435	....	....	....
	Models with 14600 lb or 16000 lb Axle and 54" Multi-leaf Spring	F6HT-18045-CC	OIO	85055	89439	....	....	....
	Models with 8500 or 9000 lb Axle and 54" Taperleaf Spring	F6HT-18045-HB F6HT-18045-HC	OIO	85054	....	....	....	....
	Models with FAS II (40,000 lb) Rear Air Suspension	16-15817-000 16-13957-000	OIO	....	....	85724	89443	....
	Models with Hendrickson 40LH Model Tandem Axle	57241-2	OIO	....	....	83109	....	....
	Models with Hendrickson HAS Rear Air Suspension	F6HT-18080-FC 47902-28	OIO	....	....	85013	89414	....
99-03	Models with 12000 lb Taperleaf Front Suspension	471700131646 10-13205-000	OIO	85918	89449	....	....	....

### A9513

99-01	All Models with 12000 lb, 13200 lb or 14600 lb Axle and 60" Taperleaf Spring	F6HT-18045-EB F6HT-18045-EC	OIO	85055	89439	....	....	....
	All Models with 23000 lb Axle and 52" Taperleaf Softride Rear Suspension	F6HT-18080-CA	OIO	....	....	85314	89425	....
	All with 13200 lb or 14600 lb Axle and 54" Taperleaf Spring	F6HT-18045-GC	OIO	85030	89440	....	....	....
	Models with 10000 lb or 12000 lb Axle and 54" Taperleaf Spring	F6HT-18045-AC	OIO	85054	....	....	....	....
	Models with 12000 lb Taperleaf Front Suspension	471700131646 10-13205-000	OIO	85918	89449	....	....	....
	Models with 12000 or 13200 lb Axle and 54" Multileaf Spring	F6HT-18045-BC	OIO	85047	89435	....	....	....
	Models with 14600 lb or 16000 lb Axle and 54" Multi-leaf Spring	F6HT-18045-CC	OIO	85055	89439	....	....	....
	Models with 8500 or 9000 lb Axle and 54" Taperleaf Spring	F6HT-18045-HB F6HT-18045-HC	OIO	85054	....	....	....	....
	Models with FAS II (40,000 lb) Rear Air Suspension	16-15817-000 16-13957-000	OIO	....	....	85724	89443	....
	Models with Hendrickson 40LH Model Tandem Axle	57241-2	OIO	....	....	83109	....	....

# APPLICATION GUIDE

Year	Fitment Notes	OEM#					
			Fleetline	GasSLX	Fleetline	GasSLX	Cab Shock/ Specialty Shock

## STERLING TRUCK

### A9513 (cont)

99-01	Models with Hendrickson HAS Rear Air Suspension	F6HT-18080-FC 47902-28	....	....	85013	89414	....
-------	---	---------------------------	------	------	-------	-------	------

## STERLING TRUCK

### A9522

99	All Models with 12000 lb, 13200 lb or 14600 lb Axle and 60" Taperleaf Spring	F6HT-18045-EB F6HT-18045-EC	85055	89439	....	....	....
	All Models with 23000 lb Axle and 52" Taperleaf Softride Rear Suspension	F6HT-18080-CA	....	....	85314	89425	....
	All with 13200 lb or 14600 lb Axle and 54" Taperleaf Spring	F6HT-18045-GC	85030	89440	....	....	....
	Models with 10000 lb or 12000 lb Axle and 54" Taperleaf Spring	F6HT-18045-AC	85054	....	....	....	....
	Models with 12000 lb Taperleaf Front Suspension	471700131646 10-13205-000	85918	89449	....	....	....
	Models with 12000 or 13200 lb Axle and 54" Multileaf Spring	F6HT-18045-BC	85047	89435	....	....	....
	Models with 14600 lb or 16000 lb Axle and 54" Multi-leaf Spring	F6HT-18045-CC	85055	89439	....	....	....
	Models with 8500 or 9000 lb Axle and 54" Taperleaf Spring	F6HT-18045-HB F6HT-18045-HC	85054	....	....	....	....
	Models with FAS II (40,000 lb) Rear Air Suspension	16-15817-000 16-13957-000	....	....	85724	89443	....
	Models with Hendrickson 40LH Model Tandem Axle	57241-2	....	....	83109	....	....
	Models with Hendrickson HAS Rear Air Suspension	F6HT-18080-FC 47902-28	....	....	85013	89414	....

### ACTERRA

	Models with 11000 to 12000 lb Front axle 85000 Series	6803230300	85006	....	....	....	....
10	All Models with Freightliner TufTrac Rear Air Suspension	481700125969 16-15770-000	....	....	85956	....	....
	Models with 15000 lb Rear Suspension	6803260000	....	....	83120	....	....
	Models with FAS II (40,000 lb) Rear Air Suspension	16-15817-000 16-13957-000 XC45-18080-BA	....	....	85724	89443	....
	Models with Hendrickson Front Airtek	58913-003L 471700131331 58913-003	85932	89453	....	....	....
01-09	Models with 10000 to 12000 lb. Taper-leaf Spring Suspension 85000 Series	10-12390-000	85920	....	....	....	....
	Models with 10000 to 12000 lb. Taper-leaf Spring Suspension 89000 Series	10-12390-000	....	89503	....	....	....
	Models with 6000 to 9000 lb Front axle 85000 Series	10-12388-000	85920	....	....	....	....
	Models with 6000 to 9000 lb Front axle 89000 Series	10-12388-000	....	89503	....	....	....
08	All Models with Freightliner TufTrac Rear Air Suspension	481700125969 16-15770-000	....	....	85956	....	....
	Models with 15000 lb Rear Suspension	6803260000	....	....	83120	....	....
	Models with FAS II (40,000 lb) Rear Air Suspension	16-15817-000 16-13957-000 XC45-18080-BA	....	....	85724	89443	....
	Models with Hendrickson Front Airtek	58913-003L 471700131331 58913-003	85932	89453	....	....	....
03-06	All Models with Freightliner TufTrac Rear Air Suspension	481700125969 16-15770-000	....	....	85956	....	....
	Models with 15000 lb Rear Suspension	6803260000	....	....	83120	....	....
	Models with FAS II (40,000 lb) Rear Air Suspension	16-15817-000 16-13957-000 XC45-18080-BA	....	....	85724	89443	....
	Models with Hendrickson Front Airtek	58913-003L 471700131331 58913-003	85932	89453	....	....	....

### ACTERRA 5500

01-07	Models with 15000 lb Rear Suspension	6803260000	....	....	83120	....	....
	Models with FAS II (40,000 lb) Rear Air Suspension	16-15817-000 16-13957-000 XC45-18080-BA	....	....	85724	89443	....



# APPLICATION GUIDE

Year	Fitment Notes	OEM#					
			Fleetline	GasSLX	Fleetline	GasSLX	Cab Shock Specialty Shock

## STERLING TRUCK

### ACTERRA 5500 (cont)

01-07	Models with Hendrickson Front Airtek	58913-003L 471700131331 58913-003	OO	85932	89453			
-------	--------------------------------------	---	----	-------	-------	--	--	--

### ACTERRA 6500

02-07	Models with 15000 lb Rear Suspension	6803260000				O	83120		
	Models with FAS II (40,000 lb) Rear Air Suspension	16-15817-000 16-13957-000 XC45-18080-BA				OO	85724	89443	
	Models with Hendrickson Front Airtek	58913-003L 471700131331 58913-003	OO	85932	89453				

### ACTERRA 7500

01-07	Models with 15000 lb Rear Suspension	6803260000				O	83120		
	Models with FAS II (40,000 lb) Rear Air Suspension	16-15817-000 16-13957-000 XC45-18080-BA				OO	85724	89443	
	Models with Hendrickson Front Airtek	58913-003L 471700131331 58913-003	OO	85932	89453				

### ACTERRA 8500

01-03	Models with 15000 lb Rear Suspension	6803260000				O	83120		
	Models with FAS II (40,000 lb) Rear Air Suspension	16-15817-000 16-13957-000 XC45-18080-BA				OO	85724	89443	
	Models with Hendrickson Front Airtek	58913-003L 471700131331 58913-003	OO	85932	89453				

### AT9513

99-01	Models with 10000 lb or 12000 lb Axle and 54" Taperleaf Spring	F6HT-18045-AC	OO	85054				
	Models with 8500 or 9000 lb Axle and 54" Taperleaf Spring	F6HT-18045-HB F6HT-18045-HC	OO	85054				

### AT9522

99-00	Models with 10000 lb or 12000 lb Axle and 54" Taperleaf Spring	F6HT-18045-AC	OO	85054				
	Models with 8500 or 9000 lb Axle and 54" Taperleaf Spring	F6HT-18045-HB F6HT-18045-HC	OO	85054				

## CARGO LINE

98	SC-7000 or SC-8000 Models with 12000 or 13000 lb. Axles 85000 Series	F6HT-18045-LA	OO	85376				
	SC-7000 or SC-8000 Models with 16000 lb. Multileaf Spring 85000 Series	F6HT-18045-AA	OO	85054				

## L - LINE 7500 SERIES - SHORT HAUL TRACTOR

	Models with 10000 lb Front Axle 89000 Series	F6HT-18045-KA	OO		89402			
--	--	---------------	----	--	-------	--	--	--

## L - LINE 8500 SERIES - CONVENTIONAL CAB

98	LT-8501 (101" BBC) Models with 8500 or 9000 lb Axle and 54" Taperleaf Spring 85000 Series	F6HT-18045-HB F6HT-18045-HC	OO	85054				
	LT-8000 Models with 12000 or 13000 lb Axles 85000 Series	F6HT-18045-LA	OO	85376				
	LT-8000 Models with 16000 lb. Multileaf Spring 85000 Series	F6HT-18045-AA	OO	85054				
	LT-8501 (101" BBC) Models with 8500 or 9000 lb Axle and 54" Multileaf Spring 89000 Series	F6HT-18045-JB F6HT-18045-JC	OO		89402			

## L - LINE 9500 SERIES - CONVENTIONAL CAB

98-09	LT-9501, LT-9511, LT-9513 or LT-9513 (113" & 122" BBC) Models with 8500 or 9000 lb Axle and 54" Multileaf Spring 89000 Series	F6HT-18045-JB F6HT-18045-JC	OO		89402			
	LT-9501, LT-9511, LT-9513 or LT-9513 (113" & 122" BBC) Models with 8500 or 9000 lb Axle and 54" Taperleaf Spring 85000 Series	F6HT-18045-HB F6HT-18045-HC	OO	85054				

## L8500

99-10	All Models with 23000 lb Axle and 52" Taperleaf Softride Rear Suspension	F6HT-18080-CA				OO	85314	89425	
-------	--	---------------	--	--	--	----	-------	-------	--

# APPLICATION GUIDE

Year	Fitment Notes	OEM#					
			Fleetline	GasSLX	Fleetline	GasSLX	Cab Shock/ Specialty Shock

## STERLING TRUCK

### L8500 (cont)

99-10	All with 13200 lb or 14600 lb Axle and 54" Taperleaf Spring	F6HT-18045-GC	○	85030	89440	○	....	....	....
	Models with 12000 lb, 13200 lb or 14600 lb Axle and 60" Taperleaf Spring	F6HT-18045-EB F6HT-18045-EC	○	85055	89439	○	....	....	....
	Models with 12000 or 13200 lb Axle and 54" Multileaf Spring	F6HT-18045-BC	○	85047	89435	○	....	....	....
	Models with 14600 lb or 16000 lb Axle and 54" Multi-leaf Spring	F6HT-18045-CC	○	85055	89439	○	....	....	....
	Models with FAS II (40,000 lb) Rear Air Suspension	16-15817-000 16-13957-000	○	....	....	○	85724	89443	....
	Models with Hendrickson HAS Rear Air Suspension	F6HT-18080-FC 47902-28	○	....	....	○	85013	89414	....

## STERLING TRUCK

### L8501

99	All Models with 23000 lb Axle and 52" Taperleaf Softride Rear Suspension	F6HT-18080-CA	○	....	....	○	85314	89425	....
	All with 13200 lb or 14600 lb Axle and 54" Taperleaf Spring	F6HT-18045-GC	○	85030	89440	○	....	....	....
	Models with 12000 lb, 13200 lb or 14600 lb Axle and 60" Taperleaf Spring	F6HT-18045-EB F6HT-18045-EC	○	85055	89439	○	....	....	....
	Models with 12000 or 13200 lb Axle and 54" Multileaf Spring	F6HT-18045-BC	○	85047	89435	○	....	....	....
	Models with 14600 lb or 16000 lb Axle and 54" Multi-leaf Spring	F6HT-18045-CC	○	85055	89439	○	....	....	....
	Models with FAS II (40,000 lb) Rear Air Suspension	16-15817-000 16-13957-000	○	....	....	○	85724	89443	....
	Models with Hendrickson HAS Rear Air Suspension	F6HT-18080-FC 47902-28	○	....	....	○	85013	89414	....

### L8511

99-00	All Models with 23000 lb Axle and 52" Taperleaf Softride Rear Suspension	F6HT-18080-CA	○	....	....	○	85314	89425	....
	Models with 12000 lb, 13200 lb or 14600 lb Axle and 60" Taperleaf Spring	F6HT-18045-EB F6HT-18045-EC	○	85055	89439	○	....	....	....
	Models with 12000 or 13200 lb Axle and 54" Multileaf Spring	F6HT-18045-BC	○	85047	89435	○	....	....	....
	Models with 14600 lb or 16000 lb Axle and 54" Multi-leaf Spring	F6HT-18045-CC	○	85055	89439	○	....	....	....
	Models with FAS II (40,000 lb) Rear Air Suspension	16-15817-000 16-13957-000	○	....	....	○	85724	89443	....

### L8513

99-01	All Models with 23000 lb Axle and 52" Taperleaf Softride Rear Suspension	F6HT-18080-CA	○	....	....	○	85314	89425	....
	All with 13200 lb or 14600 lb Axle and 54" Taperleaf Spring	F6HT-18045-GC	○	85030	89440	○	....	....	....
	Models with 12000 lb, 13200 lb or 14600 lb Axle and 60" Taperleaf Spring	F6HT-18045-EB F6HT-18045-EC	○	85055	89439	○	....	....	....
	Models with 12000 or 13200 lb Axle and 54" Multileaf Spring	F6HT-18045-BC	○	85047	89435	○	....	....	....
	Models with 14600 lb or 16000 lb Axle and 54" Multi-leaf Spring	F6HT-18045-CC	○	85055	89439	○	....	....	....
	Models with FAS II (40,000 lb) Rear Air Suspension	16-15817-000 16-13957-000	○	....	....	○	85724	89443	....
	Models with Hendrickson HAS Rear Air Suspension	F6HT-18080-FC 47902-28	○	....	....	○	85013	89414	....

### L9500

99-10	All Models with 23000 lb Axle and 52" Taperleaf Softride Rear Suspension	F6HT-18080-CA	○	....	....	○	85314	89425	....
	All with 13200 lb or 14600 lb Axle and 54" Taperleaf Spring	F6HT-18045-GC	○	85030	89440	○	....	....	....
	Models with 12000 lb, 13200 lb or 14600 lb Axle and 60" Taperleaf Spring	F6HT-18045-EB F6HT-18045-EC	○	85055	89439	○	....	....	....
	Models with 12000 or 13200 lb Axle and 54" Multileaf Spring	F6HT-18045-BC	○	85047	89435	○	....	....	....
	Models with 14600 lb or 16000 lb Axle and 54" Multi-leaf Spring	F6HT-18045-CC	○	85055	89439	○	....	....	....
	Models with FAS II (40,000 lb) Rear Air Suspension	16-15817-000 16-13957-000	○	....	....	○	85724	89443	....
	Models with Hendrickson 40LH Model Tandem Axle	57241-2	○	....	....	○	83109	....	....
	Models with Hendrickson HAS Rear Air Suspension	F6HT-18080-FC 47902-28	○	....	....	○	85013	89414	....

# APPLICATION GUIDE

Year	Fitment Notes	OEM#					
			Fleetline	GasSLX	Fleetline	GasSLX	Cab Shock Specialty Shock

## STERLING TRUCK

### L9501

99-00	All Models with 23000 lb Axle and 52" Taperleaf Softride Rear Suspension	F6HT-18080-CA	....	....	O	85314	89425	....	
	All with 13200 lb or 14600 lb Axle and 54" Taperleaf Spring	F6HT-18045-GC	O	85030	89440	....	....	....	
	Models with 12000 lb, 13200 lb or 14600 lb Axle and 60" Taperleaf Spring	F6HT-18045-EB F6HT-18045-EC	O	85055	89439	....	....	....	
	Models with 12000 or 13200 lb Axle and 54" Multileaf Spring	F6HT-18045-BC	O	85047	89435	....	....	....	
	Models with 14600 lb or 16000 lb Axle and 54" Multi-leaf Spring	F6HT-18045-CC	O	85055	89439	....	....	....	
	Models with FAS II (40,000 lb) Rear Air Suspension	16-15817-000 16-13957-000	O	....	....	O	85724	89443	....
	Models with Hendrickson 40LH Model Tandem Axle	57241-2	O	....	....	O	83109	....	....
	Models with Hendrickson HAS Rear Air Suspension	F6HT-18080-FC 47902-28	O	....	....	O	85013	89414	....

### L9511

99-01	All Models with 23000 lb Axle and 52" Taperleaf Softride Rear Suspension	F6HT-18080-CA	....	....	O	85314	89425	....	
	All with 13200 lb or 14600 lb Axle and 54" Taperleaf Spring	F6HT-18045-GC	O	85030	89440	....	....	....	
	Models with FAS II (40,000 lb) Rear Air Suspension	16-15817-000 16-13957-000	O	....	....	O	85724	89443	....
	Models with Hendrickson 40LH Model Tandem Axle	57241-2	O	....	....	O	83109	....	....
	Models with Hendrickson HAS Rear Air Suspension	F6HT-18080-FC 47902-28	O	....	....	O	85013	89414	....
99-00	Models with 12000 lb, 13200 lb or 14600 lb Axle and 60" Taperleaf Spring	F6HT-18045-EB F6HT-18045-EC	O	85055	89439	....	....	....	
	Models with 12000 or 13200 lb Axle and 54" Multileaf Spring	F6HT-18045-BC	O	85047	89435	....	....	....	
	Models with 14600 lb or 16000 lb Axle and 54" Multi-leaf Spring	F6HT-18045-CC	O	85055	89439	....	....	....	

### L9513

99-00	All Models with 23000 lb Axle and 52" Taperleaf Softride Rear Suspension	F6HT-18080-CA	....	....	O	85314	89425	....	
	All with 13200 lb or 14600 lb Axle and 54" Taperleaf Spring	F6HT-18045-GC	O	85030	89440	....	....	....	
	Models with 12000 lb, 13200 lb or 14600 lb Axle and 60" Taperleaf Spring	F6HT-18045-EB F6HT-18045-EC	O	85055	89439	....	....	....	
	Models with 12000 or 13200 lb Axle and 54" Multileaf Spring	F6HT-18045-BC	O	85047	89435	....	....	....	
	Models with 14600 lb or 16000 lb Axle and 54" Multi-leaf Spring	F6HT-18045-CC	O	85055	89439	....	....	....	
	Models with FAS II (40,000 lb) Rear Air Suspension	16-15817-000 16-13957-000	O	....	....	O	85724	89443	....
	Models with Hendrickson 40LH Model Tandem Axle	57241-2	O	....	....	O	83109	....	....
	Models with Hendrickson HAS Rear Air Suspension	F6HT-18080-FC 47902-28	O	....	....	O	85013	89414	....

### L9522

99	All Models with 23000 lb Axle and 52" Taperleaf Softride Rear Suspension	F6HT-18080-CA	....	....	O	85314	89425	....	
	All with 13200 lb or 14600 lb Axle and 54" Taperleaf Spring	F6HT-18045-GC	O	85030	89440	....	....	....	
	Models with 12000 lb, 13200 lb or 14600 lb Axle and 60" Taperleaf Spring	F6HT-18045-EB F6HT-18045-EC	O	85055	89439	....	....	....	
	Models with 12000 or 13200 lb Axle and 54" Multileaf Spring	F6HT-18045-BC	O	85047	89435	....	....	....	
	Models with 14600 lb or 16000 lb Axle and 54" Multi-leaf Spring	F6HT-18045-CC	O	85055	89439	....	....	....	
	Models with FAS II (40,000 lb) Rear Air Suspension	16-15817-000 16-13957-000	O	....	....	O	85724	89443	....
	Models with Hendrickson 40LH Model Tandem Axle	57241-2	O	....	....	O	83109	....	....
	Models with Hendrickson HAS Rear Air Suspension	F6HT-18080-FC 47902-28	O	....	....	O	85013	89414	....

### LT9500

99-08	Models with O.E.M. Number	F6HZ-5K407-AB	....	....	O	....	....	83034
-------	---------------------------	---------------	------	------	---	------	------	-------



# APPLICATION GUIDE

Year	Fitment Notes	OEM#					
			Fleetline	GasSLX	Fleetline	GasSLX	Cab Shock\ Specialty Shock

## THOMAS

## THOMAS

### VARIOUS (cont)

03	Models with Hendrickson Comfort Air Rear Air Suspension 83000 Series	60670-006 60670-006L		....	....	O O	83147	....	....	
	ROC Front, SAF-T-Liner 83000 Series	61300285 GBL651442		83102	....	....	....	....	....	
	SAF-T-Liner HDX Models with Hendrickson Comfort Air Rear Air Suspension 85000 Series	471700131545 60998-001 60998-003		....	....	....	O O	85006	....	....
	SAF-T-Liner School Bus MVP-ER & MVP-EF 85000 Series	61300219 70445 61300222 61300223	O O	85014	....	....	....	....	....	
	School Bus 85000 Series	614974	O O	85304	....	....	....	....	....	
		00614966 300-0614966		....	....	....	O O	85307	....	....
	Type C Conventional Buses (65 capacity) with FAS II Rear Air Suspension To 2017 85000 Series	16-15817-000 16-18708-000 61310434 61310478		....	....	....	O O O	85724	....	....
Type C Conventional Buses (65 capacity) with FAS II Rear Air Suspension To 2017 89000 Series	16-15817-000 16-18708-000 61310434 61310478		....	....	....	O O O	....	89443	....	
05-22	Models with Freightliner B2 Bus Chassis & 15000 lb Rear Suspension 83000 Series	6803260000		....	....	O T	83120	....	....	
03	Type C Conventional School buses (65 capacity) with O.E.M. Number 85000 Series	6803230300 GBL665538	O O	85006	....	....	....	....	....	

## THOR MOTOR COACH

## THOR MOTOR COACH

### CHALLENGER

05-08	MotorHomes with Ford F53 Chassis with 16,000 lb GVW to 22,000 lb GVW 83000 Series	ASH-1229 ASH-1228 9U94-18045-AA ASH-1205 AT-620 ASH-1022 1C34-18045-AA ASH-294 9U9Z-18124-A ASH-25822 ASH-25823 1C34-18045-JA AT-766	O O	83209	....	....	....	....	....	
		ASH-1206 9U94-18080-AA AT-621 ASH-25824 9U9Z-18125-A ASH-1023 ASH-1230 ASH-137		....	....	....	O O	83122	....	....
	MotorHomes with Ford F53 Chassis with 16,000 lb GVW to 22,000 lb GVW 89000 Series	ASH-1229 ASH-1228 9U94-18045-AA ASH-1205 AT-620 ASH-1022 1C34-18045-AA ASH-294 9U9Z-18124-A ASH-25822 ASH-25823 1C34-18045-JA AT-766	O O	....	89414	....	....	....	....	....
	ASH-1206 9U94-18080-AA AT-621 ASH-25824 9U9Z-18125-A ASH-1023 ASH-1230 ASH-137		....	....	....	....	O O	89406	....	....

### CLASS A MOTORHOMES

06	Astoria Series MotorHomes with Freightliner XC Chassis ADL200 Suspension w/ 20K Rear 85000 Series	16-16873-000		....	....	O O	85029	....	....
	Astoria Series MotorHomes with Freightliner XC Chassis AS120 Front Suspension 83000 Series	16-16874-000 16-16737-000 141700131810	O O	83160	....	....	....	....	....

# APPLICATION GUIDE

Year	Fitment Notes	OEM#					
			Fleetline	GasSLX	Fleetline	GasSLX	Cab Shock/ Specialty Shock

## THOR MOTOR COACH

## THOR MOTOR COACH

### CLASS A MOTORHOMES (cont)

06	Astoria Series MotorHomes with Freightliner XC Chassis Rear Shock with O.E.M. Number 85000 Series	141700131809 16-16736-000	I T	85900	....	....	O O	85029	....	....
	Astoria Series MotorHomes with Freightliner XC Chassis ZF - IFS Front Suspension with 23,000 lb GVW or Greater 85000 Series	16-18103-000 481700000493	I T	85900	....	....	....	....	....	....
	Tuscany Series MotorHomes with Freightliner XC Chassis ADL200 Suspension w/ 20K Rear 85000 Series	16-16873-000	....	....	....	....	O O	85029	....	....
	Tuscany Series MotorHomes with Freightliner XC Chassis AS120 Front Suspension 83000 Series	16-16874-000 16-16737-000 141700131810	O O	83160	....	....	....	....	....	....
	Tuscany Series MotorHomes with Freightliner XC Chassis Rear Shock with O.E.M. Number 85000 Series	141700131809 16-16736-000	....	....	....	....	O O	85029	....	....
	Tuscany Series MotorHomes with Freightliner XC Chassis ZF - IFS Front Suspension with 23,000 lb GVW or Greater 85000 Series	16-18103-000 481700000493	I T	85900	....	....	....	....	....	....
02-05	Escaper Series MotorHomes with Freightliner XC Chassis ADL200 Suspension w/ 20K Rear 85000 Series	16-16873-000	....	....	....	....	O O	85029	....	....
	Escaper Series MotorHomes with Freightliner XC Chassis AS120 Front Suspension 83000 Series	16-16874-000 16-16737-000 141700131810	O O	83160	....	....	....	....	....	....
	Escaper Series MotorHomes with Freightliner XC Chassis Rear Shock with O.E.M. Number 85000 Series	141700131809 16-16736-000	....	....	....	....	O O	85029	....	....
	Escaper Series MotorHomes with Freightliner XC Chassis ZF - IFS Front Suspension with 23,000 lb GVW or Greater 85000 Series	16-18103-000 481700000493	I T	85900	....	....	....	....	....	....
	UltraSport Series MotorHomes with Freightliner XC Chassis ADL200 Suspension w/ 20K Rear 85000 Series	16-16873-000	....	....	....	....	O O	85029	....	....
	UltraSport Series MotorHomes with Freightliner XC Chassis AS120 Front Suspension 83000 Series	16-16874-000 16-16737-000 141700131810	O O	83160	....	....	....	....	....	....
	UltraSport Series MotorHomes with Freightliner XC Chassis Rear Shock with O.E.M. Number 85000 Series	141700131809 16-16736-000	....	....	....	....	O O	85029	....	....
UltraSport Series MotorHomes with Freightliner XC Chassis ZF - IFS Front Suspension with 23,000 lb GVW or Greater 85000 Series	16-18103-000 481700000493	I T	85900	....	....	....	....	....	....	

### HURRICANE

04-10	MotorHomes with Ford F53 Chassis with 16,000 lb GVW to 22,000 lb GVW 83000 Series	ASH-1229 ASH-1228 9U94-18045-AA ASH-1205 AT-620 ASH-1022 1C34-18045-AA ASH-294 9U9Z-18124-A ASH-25822 ASH-25823 1C34-18045-JA AT-766	O O	83209	....	....	....	....	....	
		ASH-1206 9U94-18080-AA AT-621 ASH-25824 9U9Z-18125-A ASH-1023 ASH-1230 ASH-137	....	....	....	....	O O	83122	....	....
	MotorHomes with Ford F53 Chassis with 16,000 lb GVW to 22,000 lb GVW 89000 Series	ASH-1229 ASH-1228 9U94-18045-AA ASH-1205 AT-620 ASH-1022 1C34-18045-AA ASH-294 9U9Z-18124-A ASH-25822 ASH-25823 1C34-18045-JA AT-766	O O	....	89414	....	....	....	....	....
	ASH-1206 9U94-18080-AA AT-621 ASH-25824 9U9Z-18125-A ASH-1023 ASH-1230 ASH-137	O O	....	....	....	....	O O	89406	....	....

# APPLICATION GUIDE

Year	Fitment Notes	OEM#					
				Fleetline	GasSLX		Fleetline

## THOR MOTOR COACH OUTLAW

## THOR MOTOR COACH

07-10	MotorHomes with Ford F53 Chassis with 16,000 lb GVW to 22,000 lb GVW 83000 Series	ASH-1229 ASH-1228 9U94-18045-AA ASH-1205 AT-620 ASH-1022 1C34-18045-AA ASH-294 9U9Z-18124-A ASH-25822 ASH-25823 1C34-18045-JA AT-766	OIO	83209	....	....	....	....	....	
		ASH-1206 9U94-18080-AA AT-621 ASH-25824 9U9Z-18125-A ASH-1023 ASH-1230 ASH-137	....	....	83122	....	....	OIO	....	....
	MotorHomes with Ford F53 Chassis with 16,000 lb GVW to 22,000 lb GVW 89000 Series	ASH-1229 ASH-1228 9U94-18045-AA ASH-1205 AT-620 ASH-1022 1C34-18045-AA ASH-294 9U9Z-18124-A ASH-25822 ASH-25823 1C34-18045-JA AT-766	OIO	....	89414	....	....	....	....	....
		ASH-1206 9U94-18080-AA AT-621 ASH-25824 9U9Z-18125-A ASH-1023 ASH-1230 ASH-137	OIO	....	....	....	89406	....	....	....

## WINDSPORT

06-10	MotorHomes with Ford F53 Chassis with 16,000 lb GVW to 22,000 lb GVW 83000 Series	ASH-1229 ASH-1228 9U94-18045-AA ASH-1205 AT-620 ASH-1022 1C34-18045-AA ASH-294 9U9Z-18124-A ASH-25822 ASH-25823 1C34-18045-JA AT-766	OIO	83209	....	....	....	....	....	
		ASH-1206 9U94-18080-AA AT-621 ASH-25824 9U9Z-18125-A ASH-1023 ASH-1230 ASH-137	....	....	83122	....	....	OIO	....	....
	MotorHomes with Ford F53 Chassis with 16,000 lb GVW to 22,000 lb GVW 89000 Series	ASH-1229 ASH-1228 9U94-18045-AA ASH-1205 AT-620 ASH-1022 1C34-18045-AA ASH-294 9U9Z-18124-A ASH-25822 ASH-25823 1C34-18045-JA AT-766	OIO	....	89414	....	....	....	....	....
		ASH-1206 9U94-18080-AA AT-621 ASH-25824 9U9Z-18125-A ASH-1023 ASH-1230 ASH-137	OIO	....	....	....	89406	....	....	....



# APPLICATION GUIDE

Year	Fitment Notes	OEM#					
			Fleetline	GasSLX	Fleetline	GasSLX	Cab Shock Specialty Shock

## TIFFIN

## TIFFIN

### ALLEGRO BAY

19-24	Models with Freightliner S2RV chassis	10-13976-000	☐	85918	89449	.....	.....	.....
		16-16764-000	☐	.....	.....	☐	85724	89443

## TIFFIN MOTORHOMES INC.

## TIFFIN MOTORHOMES INC.

### VARIOUS

	Models with Hendrickson Softek Suspension 85000 Series	58913-009L 58913-009	☐	85959	.....	.....	.....	.....
--	--	-------------------------	---	-------	-------	-------	-------	-------

## TIMBREN INDUSTRIES

## TIMBREN INDUSTRIES





	Additional O.E.M. Interchanges 85000 Series	665804	☐	.....	.....	☐	85939	.....	.....
--	---	--------	---	-------	-------	---	-------	-------	-------

## TRAILMOBILE CANADA CORP.

## TRAILMOBILE CANADA CORP.

	Models with O.E.M. Number 83000 Series	43-4-279	☐	.....	.....	☐	83204	.....	.....
		43-4-239 43-6-164	☐	.....	.....	☐	83207	.....	.....
	Models with O.E.M. Number 85000 Series	43-6-028 43-4-237 43-4-277	☐	.....	.....	☐	85000	.....	.....
		43-6-137 43-4-241	☐	.....	.....	☐	85006	.....	.....
		43-6-158	☐	.....	.....	☐	85013	.....	.....
		43-8-031 43-4-236	☐	.....	.....	☐	85029	.....	.....
		43-4-235	☐	.....	.....	☐	85051	.....	.....
		43-4-278	☐	.....	.....	☐	85059	.....	.....
		43-4-239 43-6-164	☐	.....	.....	☐	.....	89407	.....
	Models with O.E.M. Number 89000 Series	43-6-158	☐	.....	.....	☐	.....	89414	.....
		43-6-028 43-4-237 43-4-277	☐	.....	.....	☐	.....	89436	.....
		43-8-022	☐	.....	.....	☐	83225	.....	.....
	Trailers with Granning Air Susp. T-350A 83000 Series	43-8-022	☐	.....	.....	☐	85000	.....	.....
	Trailers with Hendrickson Air Susp. HT230T (23,000 lb Capacity) 85000 Series	43-6-118	☐	.....	.....	☐	.....	89436	.....
	Trailers with Hendrickson Air Susp. HT230T (23,000 lb Capacity) 89000 Series	43-6-118	☐	.....	.....	☐	85029	.....	.....
	Trailers with Hendrickson Air Susp. HT250U, HT250U-Y 85000 Series	A-2212	☐	.....	.....	☐	83207	.....	.....
	Trailers with Hendrickson Air Susp. T23-RL-17 83000 Series	43-8-011	☐	.....	.....	☐	.....	89407	.....
	Trailers with Hendrickson Air Susp. T23-RL-17 89000 Series	43-8-011	☐	.....	.....	☐	85006	.....	.....
	Trailers with Hendrickson Air Susp. T23-US-6 (Non-Liftable) 85000 Series	43-8-015	☐	.....	.....	☐	85013	.....	.....
	Trailers with Hendrickson Air Susp. T23-US-9 (Liftable & Non-Liftable) 85000 Series	43-8-014	☐	.....	.....	☐	.....	89414	.....
	Trailers with Hendrickson Air Susp. T23-US-9 (Liftable & Non-Liftable) 89000 Series	43-8-014	☐	.....	.....	☐	85000	.....	.....
	Trailers with Hendrickson Air Susp. T30-US-9, -12, -14, -17 85000 Series	43-8-013	☐	.....	.....	☐	.....	89436	.....
	Trailers with Hendrickson Air Susp. T30-US-9, -12, -14, -17 89000 Series	43-8-013	☐	.....	.....	☐	83124	.....	.....
	Trailers with Neway Air Susp. AR90-1-14, AR90-1-17 83000 Series	90044089	☐	.....	.....	☐	.....	89407	.....
	Trailers with Neway Air Susp. AR90-1-14, AR90-1-17 89000 Series	90044089	☐	.....	.....	☐	83124	.....	.....
	Trailers with Neway Air Susp. AR90-14, -17, 83000 Series	90044089	☐	.....	.....	☐	.....	89407	.....
	Trailers with Neway Air Susp. AR90-14, -17, 89000 Series	90044089	☐	.....	.....	☐	85000	.....	.....
	Trailers with Neway Air Susp. AR92-14 85000 Series	90044992	☐	.....	.....	☐	.....	89436	.....
	Trailers with Neway Air Susp. AR92-14 89000 Series	90044992	☐	.....	.....	☐	83127	.....	.....
	Trailers with Neway Air Susp. AR92-17 83000 Series	90044642	☐	.....	.....	☐	.....	.....	.....











# APPLICATION GUIDE

Year	Fitment Notes	OEM#							
				Fleetline	GasSLX		Fleetline	GasSLX	Cab Shock Specialty Shock

## TRAILMOBILE CANADA CORP.

































## TRAILMOBILE CANADA CORP.

### VARIOUS (cont)

Trailers with Neway Air Susp. AR93-14 85000 Series	90045054	....	....		85051	....	....
Trailers with Neway Air Susp. AR93-17 83000 Series	90044089	....	....		83124	....	....
Trailers with Neway Air Susp. AR93-17 89000 Series	90044089	....	....		....	89407	....
Trailers with Neway Air Susp. AR95-9-HD, -12-HD,-14-HD, 17-HD 83000 Series	90044625	....	....		83125	....	....
Trailers with Neway Air Susp. RL196-14, -15 85000 Series	90044978	....	....		85059	....	....
Trailers with Neway Air Susp. RL196-16, -17 83000 Series	90044979	....	....		83113	....	....
Trailers with Reyco Air Susp. Model # 21AR ( 25,000 LB Capacity) 83000 Series	43-8-002	....	....		83209	....	....
Trailers with Reyco Air Susp. Model # 21AR ( 25,000 LB Capacity) 89000 Series	43-8-002	....	....		....	89414	....
Trailers with Reyco Air Susp. Model # 74AR ( 30,000 LB Capacity) 83000 Series	43-8-002	....	....		83209	....	....
Trailers with Reyco Air Susp. Model # 74AR ( 30,000 LB Capacity) 89000 Series	43-8-002	....	....		....	89414	....
Trailers with Reyco Air Susp. Model # 86AR 85000 Series	43-8-015	....	....		85006	....	....

## TRANSPORTATION MFG. CORP.

## TRANSPORTATION MFG. CORP.

Additional O.E.M. Interchanges 85000 Series	12L-5-70 12L-5-69		85700	....		....	....
City Cruiser 85000 Series	12TA-01-13		85303	....		....	....
City Cruiser 89000 Series	12TA-01-13		....	89422		....	....
Drive Axle 85000 Series	12J-5-10		....	....		85733	....
G 4500 Coach (Front) 85000 Series	12-05-6000		85711	....		....	....
G 4500 Coach 45 ft Coach -Tag Axle 85000 Series	12-05-6033		....	....		85339	....
G 4500 Coach Tag Axle 85000 Series	12-05-6002		....	....		85339	....
Low Floor Bus Models with O.E.M. Number 85000 Series	12L-5-99		....	....		85339	....
Models with O.E.M. Number 85000 Series	12T-1-13		85303	....		....	....
	12G-5-1		85700	....		....	....
	680349		....	....		85702	....
	680470		....	....		85713	....
Models with O.E.M. Number 89000 Series	12T-1-13		....	89422		....	....
RTS Bus with "V" Drive Rear 85000 Series	G1101590		....	....		85713	....
RTS Bus with Regular Rear 85000 Series	G1011822 22045526 22052014		....	....		85702	....
Tag Axle 85000 Series	12J-5-9		....	....		85700	....

## TUTHILL TECHNOLOGIES







## TUTHILL TECHNOLOGIES

Models with O.E.M. Number Specialty Shock	66502						646155
---	-------	---	--	--	--	--	--------

## TUTHILL TECHNOLOGIIES

## TUTHILL TECHNOLOGIIES

### DRIVE AXLE

101A, 101AR Models 85000 Series	18166-01	....	....		85704	....	....
102AR (Hvy Duty) Models 89000 Series	18286-01	....	....		....	89414	....
102AR (Special) Models 83000 Series	17146-01	....	....		83209	....	....
102AR (Special) Models 89000 Series	17146-01	....	....		....	89414	....
102AR (Standard) Models 85000 Series	12887-02	....	....		85013	....	....
102AR (Standard) Models 89000 Series	12887-02	....	....		....	89414	....
102AR for Western Star Models 85000 Series	19824-01	....	....		85006	....	....





# APPLICATION GUIDE

Year	Fitment Notes	OEM#					
			Fleetline	GasSLX	Fleetline	GasSLX	Cab Shock Specialty Shock

## UD

## UD

### 3300 (cont)

89-94	Models with O.E.M. Number	56110-Z5014 56110-Z5017 56101-Z5014 56101-Z5017	83162	....	....	....	....	....	....
-------	---------------------------	--	-------	------	------	------	------	------	------

## UNITED MANUFACTURING

## UNITED MANUFACTURING

### VARIOUS

	Models with O.E.M. Number 85000 Series	K-96-41	....	....	85304	....	....
--	--	---------	------	------	-------	------	------

## UNIVERSAL COACH

## UNIVERSAL COACH

	Models with O.E.M. Number 85000 Series	12-05-1199	....	....	85729	....	....
--	--	------------	------	------	-------	------	------

## UPS TRUCK

## UPS TRUCK

	Models with O.E.M. Number 83000 Series	P117099	....	....	83120	....	....
--	--	---------	------	------	-------	------	------

## UTILITY TRAILER MANUFACTURING COMPANY

## UTILITY TRAILER MANUFACTURING COMPANY

### FLATBEDS

	4000A Model Trailers with Hendrickson AANT 23K Intraax Air Ride (High Damping) 85000 Series	B-24023	....	....	85738	....	....
	4000A Model Trailers with Hendrickson AANT 23K Intraax Air Ride (Hvy Duty) 85000 Series	B-24125	....	....	85323	....	....
	4000A Model Trailers with Hendrickson AANT 23K Intraax Air Ride (Hvy Duty) 89000 Series	B-24125	....	....	....	89436	....
	4000A Model Trailers with Hendrickson AANT 23K Intraax Air Ride (Limited Rebound) 85000 Series	B-23361	....	....	85911	....	....
	4000A Model Trailers with Hendrickson AANT 23K Intraax Air Ride (Standard) 85000 Series	B-23566	....	....	85000	....	....
	4000A Model Trailers with Hendrickson AANT 23K Intraax Air Ride (Standard) 89000 Series	B-23566	....	....	....	89436	....
	Drop Deck Trailers with Hendrickson AANL 23K Intraax Air Ride with 12" to 17" Ride Height - High Damping 85000 Series	B-25515	....	....	85338	....	....
	Drop Deck Trailers with Hendrickson AANL 23K Intraax Air Ride with 6.5" to 9" Ride Height - High Damping 85000 Series	B-24579	....	....	85939	....	....
	Drop Deck Trailers with Hendrickson AANL 23K Intraax Air Ride with 6.5" to 9" Ride Height - Standard 85000 Series	B-23651	....	....	85045	....	....

### REEFERS & DRY VANS

	3000R Multi-Temp Trailers with Hendrickson HKANT 40K Vantraax Air Ride Heavy Duty 85000 Series	S-24088 B-24088	....	....	85000	....	....
	3000R Multi-Temp Trailers with Hendrickson HKANT 40K Vantraax Air Ride Heavy Duty 89000 Series	S-24088 B-24088	....	....	....	89436	....
	3000R Multi-Temp Trailers with Hendrickson HKANT 40K Vantraax Air Ride Standard 83000 Series	S-24088 B-24088	....	....	83389	....	....
	3000R Multi-Temp Trailers with Hendrickson HKANT 40K Vantraax Air Ride Standard 89000 Series	S-24088 B-24088	....	....	....	89436	....
	4000D Trailers with Hendrickson HKANT 40K Vantraax Air Ride Heavy Duty 85000 Series	S-24088 B-24088	....	....	85000	....	....
	4000D Trailers with Hendrickson HKANT 40K Vantraax Air Ride Heavy Duty 89000 Series	S-24088 B-24088	....	....	....	89436	....
	4000D Trailers with Hendrickson HKANT 40K Vantraax Air Ride Standard 83000 Series	S-24088 B-24088	....	....	83389	....	....
	4000D Trailers with Hendrickson HKANT 40K Vantraax Air Ride Standard 89000 Series	S-24088 B-24088	....	....	....	89436	....
	4000D-X Composite Trailers with Hendrickson HKANT 40K Vantraax Air Ride Heavy Duty 85000 Series	S-24088 B-24088	....	....	85000	....	....
	4000D-X Composite Trailers with Hendrickson HKANT 40K Vantraax Air Ride Heavy Duty 89000 Series	S-24088 B-24088	....	....	....	89436	....
	4000D-X Composite Trailers with Hendrickson HKANT 40K Vantraax Air Ride Standard 83000 Series	S-24088 B-24088	....	....	83389	....	....
	4000D-X Composite Trailers with Hendrickson HKANT 40K Vantraax Air Ride Standard 89000 Series	S-24088 B-24088	....	....	....	89436	....

# APPLICATION GUIDE

Year	Fitment Notes	OEM#					
			Fleetline	GasSLX	Fleetline	GasSLX	Cab Shock\ Specialty Shock

## VAN HOOL

### VARIOUS

## VAN HOOL

	T811, T812, T813, T814 Buses 85000 Series	6243-14040		85708	....				
	T815 4D Buses 85000 Series	6243-14040		....	....		85708	....	....
	TL 13/14 Buses 85000 Series	6243-13790		85708	....				

## VOLVO

### ADDITIONAL APPLICATIONS

## VOLVO

	1500 Models 83000 Series	.....		83122	....				
	1500 Models 89000 Series	.....		....	89406				
	1500 Models Models with Rear Suspension 83000 Series	35901-0005		....	....		83219	....	....
	1500 Models Models with Velvet Ride Suspension 85000 Series	530596		....	....		85308	....	....
	1500 Models Models with Velvet Ride Suspension 89000 Series	530596		....	....		....	89422	....
	3000, 4000 & 9000 Models - Special Unit - Four Shock Absorbers Required Per Axle 83000 Series	5554959 676081 676082		83401	....				
	3014, 3015, 3016, 3020 C.O.E. and 1500 83000 Series	.....		83122	....				
	3014, 3015, 3016, 3020 C.O.E. and 1500 89000 Series	.....		....	89406				
	9000 Models 83000 Series	.....		83122	....				
	9000 Models 89000 Series	.....		....	89406				
	Brigadier Models 85000 Series	22052336 22012065 22046483		85304	....				
	Models with Hendrickson Airtek 85000 Series	471700131920 471700131921 64838-001 20469002 20469001 64838-002		85933	....				
	Models with Hendrickson Airtek 89000 Series	471700131920 471700131921 64838-001 20469002 20469001 64838-002		....	89454				
	Models with Hendrickson HN - 400 Rear suspension 83000 Series	3971703		....	....		83112	....	....
	Road Boss, Road Boss II, Road Commander II, Road Expedito - (Four Shocks per Axle) 83000 Series	3946210		83103	....				
	Road Boss, Road Boss II, Road Commander, Road Commander II, Road Expedito II - (Four Shocks per Axle) 83000 Series	4975480 02-7005977 02-7005976 4975479		83400	....				
78-83	RC2 83000 Series	.....		....	....		83122	....	....
	RC2 89000 Series	.....		....	....		....	89406	....





### B - SERIES - BUS COWL CHASSIS

90-96	B - 600, B - 700, B - 750, B - 800, B - 7000 with 18500 lb Axle 83000 Series	D7HT-18080-DA AX-310 ASH-24446 D7HT-18080-AA E0HT-18080-AA		....	....				
				....	....		83215	....	....
77-89	B - 600, B - 700, B - 750, B - 800, B - 7000 with 18500 lb. Axle 83000 Series	D7HT-18080-DA AX-310 ASH-24446 D7HT-18080-AA E0HT-18080-AA		....	....				
				....	....		83215	....	....

### FE SERIES

	FE6 Models 83000 Series	6857668 6876828		83105	....				
	FE611, FE614 Front after CH419306 85000 Series	6794358		85040	....				
	FE614 Tractor 83000 Series	6790756		....	....		83215	....	....
	FE614 Tractor 85000 Series	6794358		85040	....				































# APPLICATION GUIDE

Year	Fitment Notes	OEM#					
			 Fleetline	GasSLX	 Fleetline	GasSLX	Cab Shock Specialty Shock















## VOLVO

## VOLVO











### FE SERIES (cont)

	FE615, FE715 85000 Series	6772218 6775412	 	85040	....	  	....	....	....
	FE7 Models up to Chassis No. 20855 85000 Series	1505190	 	....	....	  	85722	....	....
	FE7 Models with Rear Air Suspension (Drive Axle) 85000 Series	1591501	 	....	....	  	85722	....	....
	FE715 with Rear Parabolic Spring 83000 Series	6790756	 	....	....	  	83215	....	....
	Models with Rear Air Suspension and O.E.M. Number 85000 Series	8056892	 	....	....	  	85023	....	....
	Models with Rear Air Suspension and O.E.M. Number 89000 Series	8056892	 	....	....	  	....	89415	....











### N SERIES

	N10 with 5.5 Ton Front Axle 83000 Series	1593843	 	83215	....	  	....	....	....
	N11 Models 83000 Series	1593843	 	83215	....	  	....	....	....
	N12 Models 83000 Series	1593843	 	83215	....	  	....	....	....

























### VAH

11-20	VAH DayCab Models with O.E.M. Number	22662230	 	....	....	  	....	....	83905
11-14	Sleepers with O.E.M. Number	20721254 22662224	 	....	....	  	....	....	83048



































### VAH 430

17-19	Models with 42" Sleeper Cabs	20721254 22662224	 	....	....	  	....	....	83048
	VAH 430 Models with Hendrickson HAS 400 or 460 Series Rear Suspension	8083872 60675-001L 60675-001	 	....	....	  	85978	....	....















### VAH SERIES

	VAH 430 Models with 12,000 to 22,000 lb Front Axles 85000 Series	20433426 SDA471700131258	 	85081	....	  	....	....	....
17-18	VAH 630 Models with 40,000 lb Rear Air Suspension 85000 Series	21462380 21462378 471700006040 471700006038	 	....	....	  	85088	....	....
11-16	VAH 430 Models with Hendrickson HAS 400 or 460 Series Rear Suspension 85000 Series	8083872 60675-001L 60675-001	 	....	....	  	85978	....	....
14	VAH 430 Models with O.E.M. Number 85000 Series	141700005838 21436086	 	85061	....	  	....	....	....
	VAH 430 Models with O.E.M. Number 89000 Series	141700005838 21436086	 	....	89450	  	....	....	....

### VARIOUS

	Additional O.E.M. Interchanges 83000 Series	25625008 83176191 SA3019	 	....	....	  	....	....	83019
	Aero Models (WCA & WIA Models) 83000 Series	66010-0007 66010-0008 8162662	 	....	....	  	....	....	83004
	Link Cabmate Model WRC-2P 83000 Series	1202-0032	 	....	....	  	....	....	83016
	Models with O.E.M. Number 83000 Series	635869	 	....	....	  	....	....	83004
		85107095 3945842	 	....	....	  	....	....	83009
		8168617	 	....	....	  	....	....	83030
	WG Conventional Tractors with 112" cabs with Link Cabmate Model WWG112-A 83000 Series	1201-0012 1202-0012	 	....	....	  	....	....	83023

### VHD

11-24	DayCab Models with O.E.M. Number	22662230	 	....	....	  	....	....	83905
08-24	Models with T-Ride Rear Suspension	20433427 471700131256	 	....	....	  	85065	....	....
02-24	Models with 12,000 to 22,000 lb Front Axles	20434880 20353932 20433426 20414440 SDA471700131258 471700131258	 	85081	....	  	....	....	....



# APPLICATION GUIDE

Year	Fitment Notes	OEM#					
			Fleetline	GasSLX	Fleetline	GasSLX	Cab Shock Specialty Shock

## VOLVO

## VOLVO

### VHD (cont)

21-23	Models with Hendrickson HMX 400/460 Haulmax with 16.5" Saddle	60680-004L	....	....	O	83143	....	....
01-23	Models with Hendrickson HMX 400/460 Haulmax with 17.5" & 18.5" Saddle	60680-005L 60680-005	....	....	O	83142	....	....
10-22	Models with Neway ADZ Rear Suspension	90045812 471700013186 471700004423 90045605 90045803	....	....	O O O	85109	....	....
06-22	Models with Hendrickson 40,000 lb Pimaax EX and FireMaax EX Air Suspension	20782199 60657-007	....	....	O O	85072	....	....
02-21	VHD Models - With O.E.M. Number	8078546	....	....	O O	....	....	83028
01-20	Models with Hendrickson HMX 400/460 Haulmax with 16.5" Saddle	60680-004L 60680-004	....	....	O	83143	....	....
08-09	VHD Models - With O.E.M. Number	20704334 22662125	....	....	O O	....	....	83048
06	All with Neway AD-246 Air Suspension	90045132 20707753	....	....	O O	85906	89407	....
	Models with Hendrickson HAS Series Rear Suspension	23568046 60675-13 22314111	....	....	O O	85036	89405	....

### VN

	VN Models - Vertical Position (w/O.E.M. Number) 83000 Series	20721254 21368413 20704334 22662125 20496215	....	....	O O O	....	....	83048
04	Models with O.E.M. Number	471700002627 8086651 20433425 85104221	....	....	O O O	85066	89448	....
99	Models with O.E.M. Number	471700002627 8086651 20433425 85104221	....	....	O O	85066	89448	....

### VN SERIES - 2200

	Models with O.E.M. Number 85000 Series	8078195 20973993 20433424 20513881	O	85061	....	....	....	....
		8077874 8077874-P01 8086053 8169859	....	....	O O	85047	....	....
		20551628 47170000443	....	....	O O	85066	....	....
	Models with O.E.M. Number 89000 Series	8078195 20973993 20433424 20513881	O	....	89450	....	....	....
		8077874 8077874-P01 8086053 8169859	....	....	O O	....	89435	....
		20551628 47170000443	....	....	O O	....	89448	....
	VN Models - Horizontal Position 83000 Series	8078547 20496217	....	....	O O	....	....	83029
	VN Models - Vertical Position (w/O.E.M. Number) 83000 Series	8078546	....	....	O O	....	....	83028
00	Models built after May 1999 From 5/99 85000 Series	471700002627 8086651 20433425	....	....	O O	85066	....	....
	Models built after May 1999 From 5/99 89000 Series	471700002627 8086651 20433425	....	....	O O	....	89448	....

### VNL

22-24	VNL 64T-300 DayCab Models with O.E.M. Number	22662230	....	....	O O	....	....	83905
21-24	All Models with O.E.M. Number	471700014318 23159761 23159763	....	....	O O	85188	....	....
18-24	VNL 64T-860 Models with High Rise Sleeper Cabs	22662237	....	....	O O	....	....	83905

# APPLICATION GUIDE

Year	Fitment Notes	OEM#					
			Fleetline	GasSLX	Fleetline	GasSLX	Cab Shock Specialty Shock

## VOLVO

## VOLVO

### VNL (cont)

08-24	Models with Sleeper Cabs with O.E.M. Number	20721254 21391412 22866844 20704334 22662125	....	....	....	....	....	83048
00-24	Models with 12,000 - 13,200 lb Front Axles	20973993 20433424 8071881 23288402	OO	85061	89450	....	....	....
11-23	VNL 42T-300 Models - With O.E.M. Number	22662230	....	....	....	....	....	83905
21-22	300 Models with O.E.M. Number	471700014318 23159761 23159763	....	....	....	85188	....	....
10-22	Models with Neway ADZ Rear Suspension	90045812 471700013186 471700004423 90045605 90045803	....	....	....	85109	....	....
11-21	VNL 64T-300 DayCab Models with O.E.M. Number	22662230 21368411	....	....	....	....	....	83905
18-19	VNL 64T-740 Models with High Rise Sleeper Cabs	22662237	....	....	....	....	....	83905
14-19	VNL 64T-670 Models with High Rise Sleeper Cabs	22662235	....	....	....	....	....	83905
05-19	Models with Hendrickson Airtek	64838-003L 21137330 20485633 20485632 471700003832 64838-003	OO	85933	89454	....	....	....
15-18	VNL 64T-730 Models with Mid Rise Sleeper Cabs	22662237	....	....	....	....	....	83905
	VNL 64T-780 Models with High Rise Sleeper Cabs	22662237	....	....	....	....	....	83905
00-11	Models with 38,000 lb Rear Air Suspension	471700002627 20551628 20433425 471700000443	....	....	....	85066	89448	....

### VNL 300

21-24	DayCab Models with O.E.M. Number 83000 Series	22662230 21368411	....	....	....	....	....	83905
	Models with 40,000 lb Rear Air Suspension 85000 Series	471700014318 23159761	....	....	....	85188	....	....
06-24	Models with 12,000 - 13,200 lb Front Axles 85000 Series	141700005838 20973993 21436086 20433424 23288402	OO	85061	....	....	....	....
	Models with 12,000 - 13,200 lb Front Axles 89000 Series	141700005838 20973993 21436086 20433424 23288402	OO	....	89450	....	....	....
16-20	DayCab Models with O.E.M. Number	22662230 21368411	....	....	....	....	....	83905
	Models with 12,000 - 13,200 lb Front Axles	141700005838 20973993 23288402 21436086 20433424	OO	85061	89450	....	....	....
	Models with 40,000 lb Rear Air Suspension	21462378 471700006038	....	....	....	85088	....	....
	Models with Hendrickson 40,000 lb Pimaax EX and FireMaax EX Air Suspension	20782199 60657-007	....	....	....	85072	....	....
	Models with Mid-Roof Sleeper Cabs	22866844 20704334 22662125	....	....	....	....	....	83048
16-19	Models with Hendrickson Airtek	64838-003L 21137330 20485633 20485632 471700003832 64838-003	OO	85933	89454	....	....	....
11-15	Models with Mid-Roof Sleeper Cabs 83000 Series	22866844 20704334 22662125	....	....	....	....	....	83048

# APPLICATION GUIDE

Year	Fitment Notes	OEM#					
				Fleetline	GasSLX		Fleetline

## VOLVO

## VOLVO

### VNL 300 (cont)

06-14	Models with Hendrickson Airtek 85000 Series	64838-003L 21137330 20485633 20485632 471700003832 64838-003	OIO	85933	....	OIO	....	....	....
	Models with Hendrickson Airtek 89000 Series	64838-003L 21137330 20485633 20485632 471700003832 64838-003	OIO	....	89454	OIO	....	....	....
06-11	Models with 40,000 lb Rear Air Suspension 85000 Series	471700002627 20551628 20433425 471700000443	OIO	....	....	OIO	85066	....	....
	Models with 40,000 lb Rear Air Suspension 89000 Series	471700002627 20551628 20433425 471700000443	OIO	....	....	OIO	....	89448	....

### VNL 430

11-18	Models with 40,000 lb Rear Air Suspension 85000 Series	21462380 471700006040	OIO	....	....	OIO	85088	....	....
15-16	Models with 12,500 - 14,600 lb Front Axle	141700005838 21436086	OIO	85061	89450	OIO	....	....	....
	Models with 40,000 lb Rear Air Suspension	21462380 471700006040	OIO	....	....	OIO	85088	....	....
	Models with Mid-Roof Sleeper Cabs	21391412	OIO	....	....	OIO	....	....	83048
13-14	Models with Mid-Roof Sleeper Cabs 83000 Series	21391412	OIO	....	....	OIO	....	....	83048
05-14	Models with Hendrickson Airtek 85000 Series	64838-003L 21137330 20485633 20485632 471700003832 64838-003	OIO	85933	....	OIO	....	....	....
	Models with Hendrickson Airtek 89000 Series	64838-003L 21137330 20485633 20485632 471700003832 64838-003	OIO	....	89454	OIO	....	....	....
05-11	Models with 40,000 lb Rear Air Suspension 85000 Series	471700002627 20551628 20433425 471700000443	OIO	....	....	OIO	85066	....	....
	Models with 40,000 lb Rear Air Suspension 89000 Series	471700002627 20551628 20433425 471700000443	OIO	....	....	OIO	....	89448	....
06-10	Models with 12,000 - 13,200 lb Front Axles 85000 Series	20973993 20433424	OIO	85061	....	OIO	....	....	....
	Models with 12,000 - 13,200 lb Front Axles 89000 Series	20973993 20433424	OIO	....	89450	OIO	....	....	....

### VNL 630

11-19	Models with 40,000 lb Rear Air Suspension 85000 Series	21462380 471700006040	OIO	....	....	OIO	85088	....	....
17-18	Models with Hendrickson Airtek 85000 Series	64838-003L 21137330 20485633 20485632 471700003832 64838-003	OIO	85933	....	OIO	....	....	....
	Models with Hendrickson Airtek 89000 Series	64838-003L 21137330 20485633 20485632 471700003832 64838-003	OIO	....	89454	OIO	....	....	....
15-16	Models with 12,500 - 14,600 lb Front Axle	141700005838 21436086	OIO	85061	89450	OIO	....	....	....
	Models with 40,000 lb Rear Air Suspension	21462380 471700006040	OIO	....	....	OIO	85088	....	....

# APPLICATION GUIDE

Year	Fitment Notes	OEM#					
			Fleetline	GasSLX	Fleetline	GasSLX	Cab Shock Specialty Shock

## VOLVO

## VOLVO

### VNL 630 (cont)

15-16	Models with Hendrickson Airtek	64838-003L 21137330 20485633 20485632 471700003832 64838-003	OO	85933	89454	....	....	....
	Models with Mid-Roof Sleeper Cabs	21391412		....	....	OO	....	83048
13-14	Models with Mid-Roof Sleeper Cabs 83000 Series	21391412		....	....	OO	....	83048
06-14	Models with Hendrickson Airtek 85000 Series	64838-003L 21137330 20485633 20485632 471700003832 64838-003	OO	85933	....	....	....	....
	Models with Hendrickson Airtek 89000 Series	64838-003L 21137330 20485633 20485632 471700003832 64838-003	OO	....	89454	....	....	....
06-11	Models with 40,000 lb Rear Air Suspension 85000 Series	20551628 471700000443		....	....	OO	85066	....
	Models with 40,000 lb Rear Air Suspension 89000 Series	20551628 471700000443		....	....	OO	....	89448
06-10	Models with 12,000 - 13,200 lb Front Axles 85000 Series	20973993 20433424	OO	85061	....	....	....	....
	Models with 12,000 - 13,200 lb Front Axles 89000 Series	20973993 20433424	OO	....	89450	....	....	....

### VNL 670

11-19	Models with 40,000 lb Rear Air Suspension 85000 Series	21462380 471700006040		....	....	OO	85088	....
17-18	Models with Hendrickson Airtek 85000 Series	64838-003L 21137330 20485633 20485632 471700003832 64838-003	OO	85933	....	....	....	....
	Models with Hendrickson Airtek 89000 Series	64838-003L 21137330 20485633 20485632 471700003832 64838-003	OO	....	89454	....	....	....
15-16	Models with 12,500 - 14,600 lb Front Axle	141700005838 21436086	OO	85061	89450	....	....	....
	Models with 40,000 lb Rear Air Suspension	21462380 471700006040		....	....	OO	85088	....
	Models with Hendrickson Airtek	64838-003L 21137330 20485633 20485632 471700003832 64838-003	OO	85933	89454	....	....	....
	Models with Mid-Roof Sleeper Cabs	21391412		....	....	OO	....	83048
	Sleeper Cab Models with O.E.M. Number	22662235		....	....	OO	....	83905
13-14	Models with Mid-Roof Sleeper Cabs 83000 Series	21391412		....	....	OO	....	83048
06-14	Models with Hendrickson Airtek 85000 Series	64838-003L 21137330 20485633 20485632 471700003832 64838-003	OO	85933	....	....	....	....
	Models with Hendrickson Airtek 89000 Series	64838-003L 21137330 20485633 20485632 471700003832 64838-003	OO	....	89454	....	....	....
06-11	Models with 40,000 lb Rear Air Suspension 85000 Series	20551628 471700000443		....	....	OO	85066	....
	Models with 40,000 lb Rear Air Suspension 89000 Series	20551628 471700000443		....	....	OO	....	89448
06-10	Models with 12,000 - 13,200 lb Front Axles 85000 Series	20973993 20433424	OO	85061	....	....	....	....

# APPLICATION GUIDE

Year	Fitment Notes	OEM#					
			Fleetline	GasSLX	Fleetline	GasSLX	Cab Shock\ Specialty Shock

## VOLVO

## VOLVO

### VNL 670 (cont)

06-10	Models with 12,000 - 13,200 lb Front Axles 89000 Series	20973993 20433424	OO	....	89450			
-------	---	----------------------	----	------	-------	--	--	--

### VNL 740

21-24	Models with 40,000 lb Rear Air Suspension 85000 Series	471700014318 23159761 23159763		....	....			
	Models with Mid-Roof Sleeper Cabs 83000 Series	22866844 20704334		....	....			83048
17-24	Models with 12,500 - 14,600 lb Front Axle 85000 Series	141700005838 41700014316 21436086 23288403	OO	85061	....			
	Models with 12,500 - 14,600 lb Front Axle 89000 Series	141700005838 41700014316 21436086 23288403	OO	....	89450			
17-20	Models with 12,500 - 14,600 lb Front Axle	141700005838 41700014316 21436086 23288403	OO	85061	89450			
	Models with 40,000 lb Rear Air Suspension	21462380 471700006040		....	....			85088
	Models with Mid-Roof Sleeper Cabs	22866844 20704334		....	....			83048
20	Models with 40,000 lb Rear Air Suspension	471700014318 23159761 23159763		....	....			85188
17-19	Models with Hendrickson Airtek	64838-003L 21137330 20485633 20485632 471700003832 64838-003	OO	85933	89454			

### VNL 760

21-24	Models with 12,000 - 14,600 lb Front Axles 85000 Series	23288402	OO	85061	....				
	Models with 12,000 - 14,600 lb Front Axles 89000 Series	23288402	OO	....	89450				
	Models with 13,200 lb to 14,600 lb Front Axle 85000 Series	41700014316 23288403	OO	85061	....				
	Models with 13,200 lb to 14,600 lb Front Axle 89000 Series	41700014316 23288403	OO	....	89450				
	Models with 40,000 lb Rear Air Suspension 85000 Series	471700014318 23159761 23159763			....	....			85188
	Models with Mid-Roof Sleeper Cabs 83000 Series	22866844 20704334			....	....			83048
17-20	Models with 12,500 - 14,600 lb Front Axle	141700005838 21436086	OO	85061	89450				
	Models with 40,000 lb Rear Air Suspension	21462380 471700006040		....	....			85088	
	Models with Hendrickson HAS 400 or 460 Series Rear Suspension	8083872 60675-001L 60675-001		....	....			85978	
	Models with Mid-Roof Sleeper Cabs	22866844 20704334		....	....			83048	
20	Models with 13,200 lb to 14,600 lb Front Axle	41700014316 23288403	OO	85061	89450				
	Models with 40,000 lb Rear Air Suspension	471700014318 23159761 23159763		....	....			85188	
17-19	Models with Hendrickson Airtek	64838-003L 21137330 20485633 20485632 471700003832 64838-003	OO	85933	89454				

### VNL 780

11-19	Models with Sleeper Cabs with O.E.M. Number 83000 Series	20721254 22866844 21391413		....	....			83048
-------	--	----------------------------------	--	------	------	--	--	-------

# APPLICATION GUIDE

Year	Fitment Notes	OEM#					
				Fleetline	GasSLX		Fleetline

## VOLVO

## VOLVO

### VNL 860

21-24	Models with 12,000 - 14,600 lb Front Axles 85000 Series	41700014316 23288403	OO	85061	....					
	Models with 12,000 - 14,600 lb Front Axles 89000 Series	41700014316 23288403	OO	....	89450					
	Models with 12,500 - 14,600 lb Front Axle 85000 Series	41700014316 23288403	OO	85061	....					
	Models with 12,500 - 14,600 lb Front Axle 89000 Series	41700014316 23288403	OO	....	89450					
	Models with 40,000 lb Rear Air Suspension 85000 Series	471700014318 23159761 23159763			....	....	OO	85188	....	....
	Sleeper Cab Models with O.E.M. Number 83000 Series	22662237			....	....	OO	....	....	83905
17-20	Models with 12,500 - 14,600 lb Front Axle	141700005838 21436086	OO	85061	89450					
	Models with 40,000 lb Rear Air Suspension	21462380 471700006040		....	....	OO	85088	....	....	
	Sleeper Cab Models with O.E.M. Number	22662237		....	....	OO	....	....	83905	

### VNL SERIES

11-24	300, 300U Models with 12,000 - 13,200 lb Front Axles 85000 Series	141700005838 23288402 21436086	OO	85061	....				
	300, 300U Models with 12,000 - 13,200 lb Front Axles 89000 Series	141700005838 23288402 21436086	OO	....	89450				
11-19	630 & 670 Models with 12,500 - 14,600 lb Front Axle 85000 Series	141700005838 23288402 21436086	OO	85061	....				
	630 & 670 Models with 12,500 - 14,600 lb Front Axle 89000 Series	141700005838 23288402 21436086	OO	....	89450				
11-18	430 Models with 12,500 - 14,600 lb Front Axle 85000 Series	141700005838 23288402 21436086	OO	85061	....				
	430 Models with 12,500 - 14,600 lb Front Axle 89000 Series	141700005838 23288402 21436086	OO	....	89450				
	730 & 780 Models with 12,500 - 14,600 lb Front Axle 85000 Series	141700005838 23288402 21436086	OO	85061	....				
	730 & 780 Models with 12,500 - 14,600 lb Front Axle 89000 Series	141700005838 23288402 21436086	OO	....	89450				
	730 & 780 Models with 40,000 lb Rear Air Suspension 85000 Series	21462380 471700006040			....	....	OO	85088	....
06-16	64T-830 Models with Hendrickson 40,000 lb Pimaax EX and FireMaax EX Air Suspension 85000 Series	20782199 14QK-429M2 23567823		....	....	OO	85072	....	....
	64T-830 Models with Hendrickson 40,000 lb Primaax, Pimaax EX and FireMaax EX Air Suspension 85000 Series	60657-007		....	....	OO	85072	....	....
	730 & 780 Models with Hendrickson Airtex 85000 Series	64838-003L 21137330 20485633 20485632 471700003832 64838-003	OO	85933	....				
	730 & 780 Models with Hendrickson Airtex 89000 Series	64838-003L 21137330 20485633 20485632 471700003832 64838-003	OO	....	89454				
06-11	730 & 780 Models with 40,000 lb Rear Air Suspension 85000 Series	20551628 471700000443		....	....	OO	85066	....	....
	730 & 780 Models with 40,000 lb Rear Air Suspension 89000 Series	20551628 471700000443		....	....	OO	....	89448	....
06-10	730 & 780 Models with 13,200 lb Front Axle 85000 Series	20973993 20433424	OO	85061	....				
	730 & 780 Models with 13,200 lb Front Axle 89000 Series	20973993 20433424	OO	....	89450				

### VNM

	All with 60" to 77" Mid - High Roof Sleepers (w/O.E.M. Number) 83000 Series	21391412		....	....	OO	....	....	83048
--	---	----------	--	------	------	----	------	------	-------

# APPLICATION GUIDE

Year	Fitment Notes	OEM#					
			Fleetline	GasSLX	Fleetline	GasSLX	Cab Shock Specialty Shock

## VOLVO

## VOLVO

### VNM (cont)

11-18	Models with 12,000 - 14,600 lb Front Axle	141700005838 21436086	OO	85061	89450	OO	....	....	....
18	VNM 64T-200 Day Cab Models	22662230	OO	....	....	OO	....	....	83905
13-17	VNM 64T-200 Day Cab Models	22662230 21368411 22662237	OO	....	....	OO	....	....	83905
16	VNM 64T-630 Models with High Rise Sleeper Cabs	22662235	OO	....	....	OO	....	....	83905
13	VNM 42T-200 Day Cab Models	21368411	OO	....	....	OO	....	....	83905

### VNM SERIES

	200 Models with 46,000 lb T-Ride Rear Suspension To 2016 85000 Series	20433427		....	....	OO	85065	....	....
	630 Models with 38,000 lb Rear Air Suspension To 2017 85000 Series	21462380 21462378 471700006040 471700006038		....	....	OO	85088	....	....

### VNR

21-24	Models with 12,000 lb to 12,500 lb Front Axle	23288402	OO	85061	89450	OO	....	....	....
	Models with 13,200 lb to 14,600 lb Front Axle	23288403	OO	85061	89450	OO	....	....	....
18-24	Day Cab Models with O.E.M. Number	22662230 22662235	OO	....	....	OO	....	....	83905
21-23	300 Models with O.E.M. Number	471700014318 23159761 23159763	OO	....	....	OO	85188	....	....
18-19	300 Models with 40,000 lb Rear Air Suspension	21462378 471700006038	OO	....	....	OO	85088	....	....
	400 Models with 38,000 lb Rear Air Suspension	21462380 471700006040	OO	....	....	OO	85088	....	....
	Models with 12,500 lb Front Axle	141700005838 21436086	OO	85061	89450	OO	....	....	....
	Models with Hendrickson Airtek	64838-003L 21137330 471700003832 64838-003	OO	85933	89454	OO	....	....	....
18	Models with Hendrickson HAS 400 or 460 Series Rear Suspension	8083872 60675-001L 60675-001	OO	....	....	OO	85978	....	....

### VNR 300

21-24	Models with 40,000 lb Rear Air Suspension 85000 Series	471700014318 23159761 23159763		....	....	OO	85188	....	....
	Models with O.E.M. Number 83000 Series	22662230		....	....	OO	....	....	83905
17-24	Models with 12,000 - 14,600 lb Front Axles 85000 Series	41700014316 21436086 23288403 23288402	OO	85061	....	OO	....	....	....
	Models with 12,000 - 14,600 lb Front Axles 89000 Series	41700014316 21436086 23288403 23288402	OO	....	89450	OO	....	....	....
17-20	Models with O.E.M. Number	22662230	OO	....	....	OO	....	....	83905

### VNR 400

21-24	Models with 40,000 lb Rear Air Suspension 85000 Series	471700014318 23159761 23159763		....	....	OO	85188	....	....
17-24	Models with 12,000 - 14,600 lb Front Axles 85000 Series	41700014316 21436086 23288403 23288402	OO	85061	....	OO	....	....	....
	Models with 12,000 - 14,600 lb Front Axles 89000 Series	41700014316 21436086 23288403 23288402	OO	....	89450	OO	....	....	....
	Models with O.E.M. Number 83000 Series	22662235		....	....	OO	....	....	83905
17-20	Models with O.E.M. Number	22662235	OO	....	....	OO	....	....	83905



# APPLICATION GUIDE

Year	Fitment Notes	OEM#					
			Fleetline	GasSLX	Fleetline	GasSLX	Cab Shock Specialty Shock

## VOLVO

## VOLVO

### VNR 640

17-24	Models with 12,000 - 14,600 lb Front Axles 85000 Series	41700014316 21436086 23288403 23288402	OO	85061	....				
	Models with 12,000 - 14,600 lb Front Axles 89000 Series	41700014316 21436086 23288403 23288402	OO	....	89450				
	Models with O.E.M. Number 83000 Series	22662235		....	....				83905
17-20	Models with O.E.M. Number	22662235		....	....				83905

### VNR SERIES

	640 Models with 38,000 lb Rear Air Suspension 85000 Series	21462380 471700006040				OO	85088		
--	--	--------------------------	--	--	--	----	-------	--	--

### VNX

22	VNX 84T-740 Models with High Rise Sleeper Cabs 83000 Series	22866844				OO			83048
19-21	Models with Neway ADZ Rear Suspension	90045812 471700013186 471700004423 90045605 90045803		....	....	OO	85109		
	VNX 84T-740 Models with High Rise Sleeper Cabs	22866844		....	....	OO			83048
19-20	Models with 12,500 - 14,600 lb Front Axle	141700005838 21436086	OO	85061	89450				
	VNX DayCab Models with O.E.M. Number	22662230 21368411		....	....	OO			83905
18	VNX 84T-740 Models with High Rise Sleeper Cabs 83000 Series	22866844		....	....	OO			83048
15-17	Models with Neway ADZ Rear Suspension	90045812 471700013186 471700004423 90045605 90045803		....	....	OO	85109		
	VNX DayCab Models with O.E.M. Number	22662230 21368411		....	....	OO			83905
14-17	Models with 12,500 - 14,600 lb Front Axle	141700005838 21436086	OO	85061	89450				

### VNX - SERIES

	Models with 40,000 lb Rear Air Suspension 85000 Series	21462380 471700006040				OO	85088		
--	--	--------------------------	--	--	--	----	-------	--	--

### VOCATIONAL TRUCKS

	Models with T-Ride Rear Suspension 85000 Series	8060026 20433427 8073212 8075257				OO	85065		
	WX, WXL, WXR, WG, AC Models With Hendrickson HAS-400 Rear Air Suspension 83000 Series	47902-24		....	....	OO	83137		
	WX, WXL, WXR, WG, AC Models With Hendrickson HAS-460 Rear Air Suspension 83000 Series	47902-24		....	....	OO	83137		

### VT

06-10	64T-830 Models with 40,000 lb Rear Air Suspension	20551628 471700000443				OO	85066	89448	
	64T-830 Models with Hendrickson 40,000 lb Primaax, Pimaax EX and FireMaax EX Air Suspension	60657-007		....	....	OO	85072		
	64T-880 Models with Hendrickson 40,000 lb Pimaax EX and FireMaax EX Air Suspension	20782199		....	....	OO	85072		
	All Models with 12,000 - 13,200 lb Front Axles	20973993 20433424 8071881	OO	85061	89450				
	All with 60" to 77" Mid - High Roof Sleepers (w/O.E.M. Number)	20721254		....	....	OO			83048
10	All with 60" to 77" Mid - High Roof Sleepers (w/O.E.M. Number) 83000 Series	20721254		....	....	OO			83048

### WCA & WIA SERIES

	Models with Front Dual Shocks 83000 Series	3082284 02-7005976	IT	83400					
	Models with O.E.M. Number 83000 Series	4975549	OO	83216					

# APPLICATION GUIDE

Year	Fitment Notes	OEM#					
			Fleetline	GasSLX	Fleetline	GasSLX	Cab Shock Specialty Shock

## VOLVO

## VOLVO

### WCA & WIA SERIES (cont)

	Models with O.E.M. Number 85000 Series	37301-3202 37301-0021 37301-0016 8065787	O I	85026	....	....	....	....
		37301-3201	I I	85027	....	....	....	....
	Models with O.E.M. Number and up to V.I.N. Number 657250 To 1992 85000 Series	8071524	O	....	....	O	85024	....
96-98	All with O.E.M. Number and after V.I.N. Number 723506 85000 Series	8169859	O	....	....	O	85047	....
	All with O.E.M. Number and after V.I.N. Number 723506 89000 Series	8169859	O	....	....	O	....	89435
93-95	Models with O.E.M. Number and after V.I.N. Number 657841 85000 Series	8026658	O	....	....	O	85046	....
	Models with O.E.M. Number and after V.I.N. Number 657841 89000 Series	8026658	O	....	....	O	....	89434

### WG

97-01	Models with Hendrickson HN - 402 or HN - 462 Rear Suspension	60680-003L 60680-003 57241-3	O	....	....	O	83112	....
96	Models with Hendrickson HN - 402 Rear Suspension	60680-003L 60680-003 57241-3	O	....	....	O	83112	....

### WG SERIES

	Models with O.E.M. Number 85000 Series	37301-3201	I I	85027	....	....	....	....
		35901-3201	O	....	....	O	85024	....
	Models with O.E.M. Number To 1992 85000 Series	8065787	O	85026	....	....	....	....
		8071524	O	....	....	O	85024	....
93-95	Models with O.E.M. Number 85000 Series	8026658	O	....	....	O	85046	....
	Models with O.E.M. Number 89000 Series	8026658	O	....	....	O	....	89434

### WH SERIES

	WHS, WHR, WHL or WHE Models with Front Dual Shocks 83000 Series	3082284 02-7005976	I I	83400	....	....	....	....
	WHS, WHR, WHL or WHE Models with Front Single Shocks 85000 Series	37301-0021	O I	85026	....	....	....	....
	WHS, WHR, WHL or WHE Models with O.E.M. Number To 1992 85000 Series	8071524 35901-3201	O	....	....	O	85024	....
96-97	WHS, WHR, WHL or WHE Models with O.E.M. Number 85000 Series	8169859	O	....	....	O	85047	....
	WHS, WHR, WHL or WHE Models with O.E.M. Number 89000 Series	8169859	O	....	....	O	....	89435
93-95	WHS, WHR, WHL or WHE Models with O.E.M. Number 85000 Series	8026658	O	....	....	O	85046	....
	WHS, WHR, WHL or WHE Models with O.E.M. Number 89000 Series	8026658	O	....	....	O	....	89434

### WX

96-04	Models with Hendrickson HN - 402 Rear Suspension	60680-003L 60680-003 57241-3	O	....	....	O	83112	....
-------	--	------------------------------------	---	------	------	---	-------	------

### WXLL

96-03	Models with Hendrickson HN - 402 or HN - 462 Rear Suspension 83000 Series	60680-003L 60680-003 57241-3	O	....	....	O	83112	....
-------	---	------------------------------------	---	------	------	---	-------	------

### WXR

96-03	Models with Hendrickson HN - 402 or HN - 462 Rear Suspension 83000 Series	60680-003L 60680-003 57241-3	O	....	....	O	83112	....
-------	---	------------------------------------	---	------	------	---	-------	------

## WABASH NATIONAL

## WABASH NATIONAL

### VARIOUS

	Trailers with Aurora part number 83000 Series	NEW900-44-979	O	....	....	O	83113	....
		NEW900-44-089	O	....	....	O	83124	....

# APPLICATION GUIDE

Year	Fitment Notes	OEM#					
			Fleetline	GasSLX	Fleetline	GasSLX	Cab Shock Specialty Shock

## WABASH NATIONAL VARIOUS (cont)

## WABASH NATIONAL

	Trailers with Aurora part number 83000 Series	NEW900-44-625	....	....	⊙	83125	....	....	
		NEW900-44-626	....	....	⊙	83126	....	....	
		NEW900-44-794 NEW900-44-642	....	....	⊙	83127	....	....	
		NEW900-44-162 NEW900-45-298	....	....	⊙	83128	....	....	
		NEW900-45-040	....	....	⊙	83130	....	....	
		FLL83203-071	....	....	⊙	83203	....	....	
		FLL83207-071	....	....	⊙	83207	....	....	
		HENS-20001	....	....	⊙	83389	....	....	
		Trailers with Aurora part number 85000 Series	HENS-20002 HENS-23566 NEW900-45-299 FLL85000-071	....	....	⊙	85000	....	....
		FLL85030-071	....	....	⊙	85030	....	....	
		NEW900-44-868	....	....	⊙	85045	....	....	
		NEW900-45-054	....	....	⊙	85051	....	....	
		HENS21292 HENS-21292	....	....	⊙	85052	....	....	
		NEW900-44-978	....	....	⊙	85059	....	....	
		DANSR1VJ100	....	....	⊙	85078	....	....	
		FRUUCE1295-901 FRUUCE1295-1	....	....	⊙	85300	....	....	
		FRUUCF8339-1	....	....	⊙	85321	....	....	
		FRUUCE2983-1	....	....	⊙	85322	....	....	
		HENS-20126	....	....	⊙	85323	....	....	
		Trailers with Aurora part number 89000 Series	FLL83207-071 NEW900-44-089	....	....	⊙	....	89407	....
		FRUUCE1295-901 FRUUCE1295-1	....	....	⊙	....	89419	....	
		NEW900-44-626	....	....	⊙	....	89430	....	
		NEW900-44-162 HENS-20002 HENS-20001 HENS-23566 FLL83203-071 HENS-20126 NEW900-45-299 FLL85000-071 NEW900-45-298	....	....	⊙	....	89436	....	
		FLL85030-071	....	....	⊙	....	89440	....	
		Trailers with Aurora part number Heavy Duty 85000 Series	HENS-24088	....	....	⊙	85000	....	....
		Trailers with Aurora part number Heavy Duty 89000 Series	HENS-24088	....	....	⊙	....	89436	....
		Trailers with Aurora part number Standard 83000 Series	HENS-24088	....	....	⊙	83389	....	....
		Trailers with Aurora part number Standard 89000 Series	HENS-24088	....	....	⊙	....	89436	....
97-21	RHP11, RHP55 and RideSentry Trailer Suspension 85000 Series	203447 202447	....	....	⊙	85919	....	....	

## WATSON & CHALIN MFG. INC. HEAVY DUTY TRAILER AIR SUSPENSION

## WATSON & CHALIN MFG. INC.

	TA-2590-14, 17 HD 83000 Series	10148	....	....	⊙	83204	....	....
	TA-3090-14, -17, -19 83000 Series	10148	....	....	⊙	83204	....	....
	TA-550-17 83000 Series	10148	....	....	⊙	83204	....	....



# APPLICATION GUIDE

Year	Fitment Notes	OEM#					
			Fleetline	GasSLX	Fleetline	GasSLX	Cab Shock Specialty Shock

**WATSON & CHALIN MFG. INC.**  
**VARIOUS (cont)**

**WATSON & CHALIN MFG. INC.**

Models with O.E.M. Number Specialty Shock	17069	OO	632147
Self-Steering Axle Shocks Specialty Shock	53000070-001	OOOO	646177

**WCAL-1000 SST**

Self - Steering Axle Suspension Systems Specialty Shock	11418	OO	646155
---	-------	----	--------

**WCAL-1100 LR**

Self - Steering Axle Suspension Systems Specialty Shock	11418	OO	646155
---	-------	----	--------

**WCAL-1100 SR**

Self - Steering Axle Suspension Systems Specialty Shock	11418	OO	646155
---	-------	----	--------

**WCAL-1100 SRLP**

Self - Steering Axle Suspension Systems Specialty Shock	11418	OO	646155
---	-------	----	--------

**WCAL-1100 SSR**

Self - Steering Axle Suspension Systems Specialty Shock	11418	OO	646155
---	-------	----	--------

**WCAL-2200 SERIES PUSHER OR TAG AXLE ASSEMBLY**

AL-2200 Models 83000 Series	10148	.....	.....	OO	83204	.....	.....
-----------------------------	-------	-------	-------	----	-------	-------	-------

**WCHL-1100 FL**

Self - Steering Axle Suspension Systems Specialty Shock	11418	OO	646155
---	-------	----	--------

**WCHL-1100 HI-LIFT**

Self - Steering Axle Suspension Systems Specialty Shock	11418	OO	646155
---	-------	----	--------

**WCTA SERIES DUMP TRAILER AIR SUSPENSION**

TA-1600-21 83000 Series	11604	.....	.....	OO	83125	.....	.....
TA-1900-15 83000 Series	10147	.....	.....	OO	83203	.....	.....
TA-1900-15 89000 Series	10147	.....	.....	OO	.....	89436	.....
TA-1900-16, -17 83000 Series	10148	.....	.....	OO	83204	.....	.....
TA-1900-18, -19 85000 Series	12128	.....	.....	OO	85005	.....	.....
TA-1900-18, -19 89000 Series	12128	.....	.....	OO	.....	89430	.....
TA-5000-DB-19, -F-19 85000 Series	12128	.....	.....	OO	85005	.....	.....
TA-5000-DB-19, -F-19 89000 Series	12128	.....	.....	OO	.....	89430	.....
TA-5000-DB-24, -DB-30, -F-24, -F-30, 83000 Series	11724	.....	.....	OO	83123	.....	.....
TA-5000-DB-24, -DB-30, -F-24, -F-30, 89000 Series	11724	.....	.....	OO	.....	89405	.....
TA-525, -DB 83000 Series	10147	.....	.....	OO	83203	.....	.....
TA-525, -DB 89000 Series	10147	.....	.....	OO	.....	89436	.....

**WCTA SERIES TRAILER AIR SUSPENSION**

TA-2075-6 83000 Series	10148	.....	.....	OO	83204	.....	.....
TA-2075-9 85000 Series	12128	.....	.....	OO	85005	.....	.....
TA-2075-9 89000 Series	12128	.....	.....	OO	.....	89430	.....
TA-250-12 83000 Series	10148	.....	.....	OO	83204	.....	.....
TA-250-6, 7.5, 9, 83000 Series	10147	.....	.....	OO	83203	.....	.....
TA-250-6, 7.5, 9, 89000 Series	10147	.....	.....	OO	.....	89436	.....
TA-251-12, -12FS, 83000 Series	10148	.....	.....	OO	83204	.....	.....
TA-251-6.5, -6.5FS, 83000 Series	10147	.....	.....	OO	83203	.....	.....



# APPLICATION GUIDE

Year	Fitment Notes	OEM#					
			Fleetline	GasSLX	Fleetline	GasSLX	Cab Shockl Specialty Shock

## WESTERN STAR

## WESTERN STAR

### 47X (cont)

22-24	Models with Neway ADZ Rear Suspension	90045812 471700013186 471700004423 90045605 90045803	....	....	OO	85109	....	....
-------	---------------------------------------	--	------	------	----	-------	------	------

### 49X

21-24	Day Cab Models w/ 12 mm Top mounting bolt	18-73207-000 814903018451	....	....	OO	....	....	83911
	Models with Airliner Rear Air Suspension with O.E.M. Number	16-20156-000	....	....	T	85205	....	....
	Models with FAS II (40,000 lb) Rear Air Suspension	16-15817-000 16-18708-000 481700006848 471700002809 SDA471700002809	....	....	OO	85724	89443	....
	Models with Freightliner TuffTrac Rear Air Suspension	SDA481700125969 481700125969 16-15770-000	....	....	OO	85956	....	....
	Models with Hendrickson HMX 400/460 Haulmax with 16.5" Saddle	60680-004L 60680-004	....	....	T	83143	....	....
	Models with Hendrickson HMX 400/460 Haulmax with 17.5" & 18.5" Saddle	60680-005L 60680-005	....	....	T	83142	....	....
	Models with Neway ADZ Rear Suspension	90045812 471700013186 471700004423 90045605 90045803	....	....	OO	85109	....	....

### 57X

23-24	Day Cab Models w/ 12 mm Top mounting bolt	18-73207-000 814903018451	....	....	OO	....	....	83911
	Models with 12000 to 13300 lb Taperleaf Front Suspension	10-14339-000	OO	83396	....	....	....	....
	Models with FAS II (40,000 lb) Rear Air Suspension	16-18708-000 471700002809 SDA471700002809	....	....	OO	85724	89443	....
	Models with Hendrickson Airtek NXT Front	58913-015L HDR 58913 015 58913-015	OO	85200	....	....	....	....
	Sleeper Cab models with Air Suspension	18-60769-000	....	....	OO	....	....	83009

### 3800

99-01	Models with Hendrickson Air Suspension	47902-13 47902-8	....	....	OO	83122	89406	....
	Models with Multi-Leaf Front Springs	37301-3401 37301-3412 37390-4403 37390-4402 37390-4401 37301-3405 37301-3404 37301-3409	OO	85053	89442	....	....	....
	Models with Neway Rear Suspension	90044907 90044025	....	....	OO	83635	....	....
98	Models with Hendrickson Air Suspension 83000 Series	47902-13 47902-8	....	....	OO	83122	....	....
	Models with Hendrickson Air Suspension 89000 Series	47902-13 47902-8	....	....	OO	....	89406	....
	Models with Multi-Leaf Front Springs 85000 Series	37301-3401 37301-3412 37390-4403 37390-4402 37390-4401 37301-3405 37301-3404 37301-3409	OO	85053	....	....	....	....
	Models with Multi-Leaf Front Springs 89000 Series	37301-3401 37301-3412 37390-4403 37390-4402 37390-4401 37301-3405 37301-3404 37301-3409	OO	....	89442	....	....	....
	Models with Neway Rear Suspension 83000 Series	90044025	....	....	OO	83209	....	....





# APPLICATION GUIDE

Year	Fitment Notes	OEM#					
			Fleetline	GasSLX	Fleetline	GasSLX	Cab Shock Specialty Shock

## WESTERN STAR

### 4800 (cont)

89-02	Models with Neway Rear Suspension	90044025	....	....	○	83209	89414	....
86-02	Conventional Tractors with Link Cabmate Model WSC4000	1201-0012 1202-0012	....	....	○	....	....	83023
81-02	Models with O.E.M. Number	66010-3402 66010-3403	....	....	○	....	....	83022

## WESTERN STAR

### 4800 & 4900 SERIES

	With Hendrickson HAS-40LH Rear Suspension 83000 Series	57241-1	....	....	○	83111	....	....
	With Neway Rear Suspension 85000 Series	90045099	....	....	○	85906	....	....

### 4800 & 4900 SERIES - CONSTELLATION CLASS

	With Neway Rear Suspension 89000 Series	90045099	....	....	○	....	89407	....
09-12	Models w/ Low Profile Rear Air Suspension 85000 Series	16-18706-000	....	....	○	85331	....	....

### 4800 & 4900 SERIES - HERITAGE CLASS

	With Neway Rear Suspension 89000 Series	90045099	....	....	○	....	89407	....
--	---	----------	------	------	---	------	-------	------

### 4800SB

12-22	Models with Freightliner TufTrac Rear Air Suspension	SDA481700125969 481700125969 16-15770-000	....	....	○	85956	....	....
	Models with Hendrickson Front Airtek	58913-003L 58913-012L 471700131331 471700006269 58913-012 58913-003	85932	89453	○	....	....	....
12-20	Models with 12000 lb Taperleaf Front Suspension	10-13809-000 471700003920	85958	....	○	....	....	....

### 4800SF

13-22	Models with Freightliner TufTrac Rear Air Suspension	SDA481700125969 481700125969 16-15770-000	....	....	○	85956	....	....
	Models with Hendrickson Front Airtek	58913-003L 58913-012L 471700131331 471700006269 58913-012 58913-003	85932	89453	○	....	....	....
13-20	Models with 12000 lb Taperleaf Front Suspension	10-13809-000 471700003920	85958	....	○	....	....	....

### 4900

01-02	Models with Hendrickson HMX 400/460 Haulmax with 16.5" Saddle	60680-004L 60680-004	....	....	○	83143	....	....
	Models with Hendrickson HMX 400/460 Haulmax with 17.5" & 18.5" Saddle	60680-005L 60680-005	....	....	○	83142	....	....
97-02	Day Cab Models	18-60772-000	....	....	○	....	....	83026
89-02	Models with Hendrickson Air Suspension	47902-13 47902-8	....	....	○	83122	89406	....
	Models with Multi-Leaf Front Springs	37301-3401 37301-3412 37390-4403 37390-4402 37390-4401 37301-3405 37301-3404 37301-3409	85053	89442	○	....	....	....
	Models with Neway Rear Suspension	90044907	....	....	○	83635	....	....
		90044025	....	....	○	83209	89414	....
86-02	Conventional Tractors with Link Cabmate Model WSC4000	1201-0012 1202-0012	....	....	○	....	....	83023
81-02	Models with O.E.M. Number	66010-3402 66010-3403	....	....	○	....	....	83022

### 4900E

01-02	Models with Hendrickson HMX 400/460 Haulmax with 16.5" Saddle	60680-004L 60680-004	....	....	○	83143	....	....
-------	---	-------------------------	------	------	---	-------	------	------

# APPLICATION GUIDE

Year	Fitment Notes	OEM#					
				Fleetline	GasSLX		Fleetline

## WESTERN STAR 4900E (cont)

01-02	Models with Hendrickson HMX 400/460 Haulmax with 17.5" & 18.5" Saddle	60680-005L 60680-005		....	....	O T	83142	....	....
00-02	Models with Hendrickson Front Airtek	58913-003L 58913-012L 471700131331 471700006269 58913-012 58913-003	O O	85932	89453		....	....	....
97-02	Day Cab Models	18-60772-000		....	....	O O O	....	....	83026
	Models with O.E.M. Number	66010-3402 66010-3403		....	....	O O O	....	....	83022

## WESTERN STAR

### 4900EX

08-22	Models with Freightliner TufTrac Rear Air Suspension	SDA481700125969 481700125969 16-15770-000		....	....	O O	85956	....	....
02-22	Models with Hendrickson Front Airtek	58913-003L 58913-012L 471700131331 471700006269 58913-012 58913-003	O O	85932	89453		....	....	....
	Models with Hendrickson HMX 400/460 Haulmax with 16.5" Saddle	60680-004L 60680-004		....	....	O T	83143	....	....
	Models with Hendrickson HMX 400/460 Haulmax with 17.5" & 18.5" Saddle	60680-005L 60680-005		....	....	O T	83142	....	....
08-20	Models with 12000 lb Taperleaf Front Suspension	10-13809-000 471700003920	O O	85958	....		....	....	....

### 4900FA

08-23	Models with Freightliner TufTrac Rear Air Suspension	SDA481700125969 481700125969 16-15770-000		....	....	O O O	85956	....	....
02-23	Models with Hendrickson HMX 400/460 Haulmax with 16.5" Saddle	60680-004L 60680-004		....	....	O T	83143	....	....
	Models with Hendrickson HMX 400/460 Haulmax with 17.5" & 18.5" Saddle	60680-005L 60680-005		....	....	O T	83142	....	....
02-22	Models with Hendrickson Front Airtek	58913-003L 58913-012L 471700131331 471700006269 58913-012 58913-003	O O	85932	89453		....	....	....
08-20	Models with 12000 lb Taperleaf Front Suspension	10-13809-000 471700003920	O O	85958	....		....	....	....
02-20	Day Cab Models	18-60772-000		....	....	O O	....	....	83026

### 4900SA

10-23	Models with Neway ADZ Rear Suspension	90045812 471700013186 471700004423 90045605 90045803		....	....	O O O	85109	....	....
08-23	Models with Freightliner TufTrac Rear Air Suspension	SDA481700125969 481700125969 16-15770-000		....	....	O O O	85956	....	....
02-23	Models with Hendrickson HMX 400/460 Haulmax with 16.5" Saddle	60680-004L 60680-004		....	....	O T	83143	....	....
	Models with Hendrickson HMX 400/460 Haulmax with 17.5" & 18.5" Saddle	60680-005L 60680-005		....	....	O T	83142	....	....
02-22	Models with Hendrickson Front Airtek	58913-003L 58913-012L 471700131331 471700006269 58913-012 58913-003	O O	85932	89453		....	....	....
08-20	Models with 20000 lb Set -Back Front Axle	10-13809-000 471700003920	O O	85958	....		....	....	....
02-20	Day Cab Models	18-60772-000		....	....	O O	....	....	83026

### 5700XE

16-22	Models with 12,000 lb to 14,600 lb Taperleaf Springs	10-13809-000 471700003920	O O	85958	....		....	....	....
	Models with Airliner Rear Air Suspension	16-20716-000		....	....	O O	85724	89443	....

# APPLICATION GUIDE

Year	Fitment Notes	OEM#					
			Fleetline	GasSLX	Fleetline	GasSLX	Cab Shock/ Specialty Shock

## WESTERN STAR 5700XE (cont)

## WESTERN STAR

16-22	Models with Hendrickson Front Airtek	58913-012L 471700006269 58913-012	OO	85932	89453	....	....	....
-------	--------------------------------------	---	----	-------	-------	------	------	------

### 5800

97-02	Models with Hendrickson Air Suspension	47902-13 47902-8	OO	....	....	OO	83122	89406	....
	Models with Multi-Leaf Front Springs	37301-3401 37301-3412 37390-4403 37390-4402 37390-4401 37301-3405 37301-3404 37301-3409	OO	85053	89442	OO	....	....	....
	Models with Neway Rear Suspension	90044907 90044025	OO	....	....	OO	83635	....	....
			OO	....	....	OO	83209	89414	....

### 5800 & 5900 SERIES - CONSTELLATION CLASS

	With Neway Rear Suspension 89000 Series	90045099	OO	....	....	OO	....	89407	....
--	---	----------	----	------	------	----	------	-------	------

### 5900

00-01	Models with Hendrickson Front Airtek	58913-003L 58913-012L 471700131331 471700006269 58913-012 58913-003	OO	85932	89453	OO	....	....	....
	89-01	All with 4 shock Front System	676081 676082 615016	OO	83401	....	OO	....	....
	Models with Hendrickson Air Suspension	47902-13 47902-8	OO	....	....	OO	83122	89406	....
	Models with Multi-Leaf Front Springs	37301-3401 37301-3412 37390-4403 37390-4402 37390-4401 37301-3405 37301-3404 37301-3409	OO	85053	89442	OO	....	....	....
	Models with Neway Rear Suspension	90044907 90044025	OO	....	....	OO	83635	....	....
			OO	....	....	OO	83209	89414	....

### 5900 & 6900 SERIES

	With Neway Rear Suspension 85000 Series	90045099	OO	....	....	OO	85906	....	....
--	---	----------	----	------	------	----	-------	------	------

### 5900 & 6900 SERIES - HERITAGE CLASS

	Additional O.E.M. Interchanges 83000 Series	1011839	OO	83216	....	OO	....	....	....
	Models with O.E.M. Number 83000 Series	28R010	OO	83216	....	OO	....	....	....
		02-7005977 02-7005976	OO	83400	....	OO	....	....	....
	Models with O.E.M. Number 85000 Series	57252	OO	85308	....	OO	....	....	....
		35901-4403	OO	....	....	OO	85060	....	....
		04-9041375 CP-5222	OO	....	....	OO	85315	....	....
		57905-1	OO	....	....	OO	85976	....	....
	Models with O.E.M. Number 89000 Series	57252	OO	....	89422	OO	....	....	....
	With Hendrickson HAS-40LH Rear Suspension 83000 Series	57241-1	OO	....	....	OO	83111	....	....
	With Hendrickson Rear Suspension 85000 Series	60675-002L 60675-002	OO	....	....	OO	85979	....	....
	With Neway Rear Suspension 89000 Series	90045099	OO	....	....	OO	....	89407	....

# APPLICATION GUIDE

Year	Fitment Notes	OEM#					
			Fleetline	GasSLX	Fleetline	GasSLX	Cab Shock\ Specialty Shock

## WESTERN STAR 6900

## WESTERN STAR

00-01	Models with Hendrickson Front Airtek	58913-003L 58913-012L 471700131331 471700006269 58913-012 58913-003	OIO	85932	89453	OIO			
89-01	All with 4 shock Front System	676081 676082 615016	OIO	83401	....	OIO	....	....	....
	Models with Hendrickson Air Suspension	47902-13 47902-8	OIO	....	....	OIO	83122	89406	....
	Models with Multi-Leaf Front Springs	37301-3401 37301-3412 37390-4403 37390-4402 37390-4401 37301-3405 37301-3404 37301-3409	OIO	85053	89442	OIO	....	....	....
	Models with Neway Rear Suspension	90044907	OIO	....	....	OIO	83635	....	....
		90044025	OIO	....	....	OIO	83209	89414	....
	Models with O.E.M. Number	66010-3402 66010-3403	OIO	....	....	OIO	....	....	83022

### 6900 SX MODELS

01-15	Models with O.E.M. Number 83000 Series	66010-3407				OIO			83065
-------	--	------------	--	--	--	-----	--	--	-------

### 6900XD

22	Models with Freightliner TufTrac Rear Air Suspension	SDA481700125969 481700125969 16-15770-000				OIO	85956		
	Models with Hendrickson Front Airtek	58913-003L 58913-012L 471700131331 471700006269 58913-012 58913-003	OIO	85932	89453	OIO	....	....	....
18-19	Models with 12000 lb Taperleaf Front Suspension	10-13809-000 471700003920	OIO	85958	....	OIO	....	....	....
	Models with Freightliner TufTrac Rear Air Suspension	SDA481700125969 481700125969 16-15770-000	OIO	....	....	OIO	85956	....	....
	Models with Hendrickson Front Airtek	58913-003L 58913-012L 471700131331 471700006269 58913-012 58913-003	OIO	85932	89453	OIO	....	....	....
09-16	Models with 12000 lb Taperleaf Front Suspension	10-13809-000 471700003920	OIO	85958	....	OIO	....	....	....
08-16	Models with Freightliner TufTrac Rear Air Suspension	SDA481700125969 481700125969 16-15770-000	OIO	....	....	OIO	85956	....	....
02-16	Models with Hendrickson Front Airtek	58913-003L 58913-012L 471700131331 471700006269 58913-012 58913-003	OIO	85932	89453	OIO	....	....	....

### VARIOUS

	Constellation Day Cab Models 83000 Series	66010-3405 814903003500				OIO			83026
	Constellation Sleeper Cab Models 83000 Series	814903003501 66010-3406 18-60773-000	OIO	....	....	OIO	....	....	83027
	Models with Link Cab Suspension 83000 Series	1202-0032	OIO	....	....	OIO	....	....	83016
	Models with O.E.M. Number 83000 Series	66010-3404 617547	OIO	....	....	OIO	....	....	83022
		GBL 654916	OIO	....	....	OIO	....	....	83026
		654846	OIO	....	....	OIO	....	....	83027

# APPLICATION GUIDE

Year	Fitment Notes	OEM#					
			Fleetline	GasSLX	Fleetline	GasSLX	Cab Shock Specialty Shock

## WESTERN UNIT STABILAIR SUSPENSION VARIOUS (cont)

## WESTERN UNIT STABILAIR SUSPENSION

	Model 893T Trailer Suspension 85000 Series	.....	.....	.....	○	85307	.....	.....	
	Model TDA204, 205, 242 - Truck Drive Axle Suspension 85000 Series	.....	.....	.....	○	85307	.....	.....	
	Models with O.E.M. Number 85000 Series	80600	.....	.....	.....	○	85300	.....	.....
		80370	.....	.....	.....	○	85304	.....	.....
		101364	.....	.....	.....	○	85305	.....	.....
		101030	.....	.....	.....	○	85307	.....	.....
		4939967	.....	.....	.....	○	85308	.....	.....
	Models with O.E.M. Number 89000 Series	80600	.....	.....	.....	○	.....	89419	.....
		4939967	.....	.....	.....	○	.....	89422	.....

## WESTPORT AXLE CORP.

## WESTPORT AXLE CORP.

Self - Steering Axle Shocks Specialty Shock	646124 143699-0185	○	○	646177
---	-----------------------	---	---	--------

## WINNEBAGO

## WINNEBAGO

### SUNSTAR NPF

23	MotorHomes with Ford F53 Chassis with 16,000 lb GVW to 22,000 lb GVW 83000 Series	ASH-25822	○	83209	.....	.....	.....
		ASH-25823	○	.....	.....	.....	.....
	ASH-25824	○	.....	.....	.....	83122	.....
	MotorHomes with Ford F53 Chassis with 16,000 lb GVW to 22,000 lb GVW 89000 Series	ASH-25822	○	.....	89414	.....	.....
ASH-25823		○	.....	.....	.....	.....	.....
		ASH-25824	○	.....	.....	.....	89406

### VISTA NPF

23	MotorHomes with Ford F53 Chassis with 16,000 lb GVW to 22,000 lb GVW 83000 Series	ASH-25822	○	83209	.....	.....	.....
		ASH-25823	○	.....	.....	.....	.....
	ASH-25824	○	.....	.....	.....	83122	.....
	MotorHomes with Ford F53 Chassis with 16,000 lb GVW to 22,000 lb GVW 89000 Series	ASH-25822	○	.....	89414	.....	.....
ASH-25823		○	.....	.....	.....	.....	.....
		ASH-25824	○	.....	.....	.....	89406

## WORKHORSE

## WORKHORSE

### VARIOUS

	Models with O.E.M. Number 83000 Series	W0011635	○	83221	.....	.....	.....
	Models with RSAS Rear Suspension 85000 Series	7805-X-1012	○	.....	.....	.....	85919
	UFO Motorhome Chassis with Hendrickson Softek Front Suspension 83000 Series	66153-002 F4-BE5-C832-MO	○	83124	.....	.....	.....
	UFO Motorhome Chassis with Hendrickson Softek Front Suspension 89000 Series	66153-002 F4-BE5-C832-MO	○	.....	89407	.....	.....

## XOS

## XOS

### ADDITIONAL O.E.M. INTERCHANGES

	Medium Duty Electric Trucks with Hendrickson Softek Suspension (10K Capacity) 85000 Series	58913-009L 58913-009	○	85959	.....	.....	.....
	Medium Duty Trucks With Hendrickson HTS Suspension (16K Capacity) 85000 Series	60665-025 60665-025L	○	.....	.....	.....	85036
	Medium Duty Trucks With Hendrickson HTS Suspension (16K Capacity) 89000 Series	60665-025 60665-025L	○	.....	.....	.....	89405



# Numerical listing

Shock	POP	Alternative No.	MTG Acc. Supplied
Pos.	Year	Application	
<b>83000 Series</b>			
<b>83101</b>	D		
R	02-13	<b>FORD F-650</b> All Models with Vari-Rate Rear Suspension	
R	02-13	<b>F-750</b> All Models with Vari-Rate Rear Suspension	
R		<b>IC CORPORATION</b> RE SCHOOL BUS	
R		<b>INTERNATIONAL</b> SERIES 4000 - SHORT CONVENTIONAL MEDIUM TRK & TRAC	
R		SERIES 8000 - CONVENTIONAL HEAVY DUTY TRACTOR	
R		SERIES 9100, 9100I - TRACTOR & STRAIGHT TRUCK	
R		SERIES 9200, 9200I - TRACTOR & STRAIGHT TRUCK	
R		SERIES 9300, 9300I, 9400 & 9400I LONG HOOD CONV.	
R		SERIES 9900, 9900I, 9900IX LONG HOOD CONV. TRUCK	
F	05-07	<b>MACK CT</b> All Models with O.E.M. Number	
F	18-24	<b>GRANITE</b> All Granite 64BR & 64FR Models with 20,000 lb Front Axle	
F	15-24	<b>GRANITE</b> All Models with 14,600 lb to 18,000 lb Multi-Leaf Front Springs	
F	12-19	<b>GU4</b> All GU432 Models with 14,600 lb to 18,000 lb Multi-Leaf Front Springs	
F	12-18	<b>GU5</b> All GU532 Models with 14,600 lb to 18,000 lb Multi-Leaf Front Springs	
F	08-19	<b>GU7</b> All GU713 Models with 14,600 lb to 18,000 lb Multi-Leaf Front Springs	
F	08-19	<b>GU8</b> All GU813 Models with 14,600 lb to 18,000 lb Multi-Leaf Front Springs	
F	08-09	<b>TITAN</b> All Models with 20,000 lb Front Axle	
<b>83102</b>	W		145089-000 (2)
F		<b>THOMAS</b> VARIOUS	
<b>83103</b>	W		145054 (2)
F	09-12	<b>AUTOCAR LLC.</b> XPEDITOR All Models with 20,000 lb Front Axle	
R		<b>INTERNATIONAL</b> SERIES 1000 FORWARD CONTROL CHASSIS	
R		SERIES 3000 - SCHOOL BUS CHASSIS	
R		<b>MOR-RYDE</b> SUSPENSION VARIOUS	
F		<b>VOLVO</b> ADDITIONAL APPLICATIONS	
<b>83105</b>	W		140780 (1)
F		<b>MACK</b> ADDITIONAL APPLICATIONS	
F	86-01	CS, MS - MID - LINER SERIES	
F	84-01	MS200P MID-LINER All Models with O.E.M. Number	
F	80-82	MS200P MID-LINER All Models with O.E.M. Number	
F	81-01	MS300P MID-LINER All Models with O.E.M. Number	
F		<b>VOLVO</b> FE SERIES	
<b>83107</b>	W		145080 (2)
F	95-97	<b>FORD B-800</b> All Models with 52" Multileaf Spring	
F	94-97	F-700 All w/ Multileaf Spring and w/ 10000, 12000 or 13200 lb Axle	
F	94	F-800 All w/ Multileaf Spring and w/ 10000, 12000 or 13200 lb Axle	
F	94-98	FT900 All w/ Multileaf Spring and w/ 10000, 12000 or 13200 lb Axle	
<b>83109</b>	W		145128 (1)
R	96-98	<b>FORD A9513</b> All Models with Hendrickson 40LH Model Tandem Axle	
R	97	A9522 All Models with Hendrickson 40LH Model Tandem Axle	
R	96-98	AT9513 All Models with Hendrickson 40LH Model Tandem Axle	
R	97-98	AT9522 All Models with Hendrickson 40LH Model Tandem Axle	
R		<b>MC NEILUS TRUCK &amp; MAN.</b> VARIOUS	

# 83000 Series

Shock	POP	Alternative No.	MTG Acc. Supplied
Pos.	Year	Application	
<b>83109</b>	W (cont)		145128 (1)
R	99-10	<b>STERLING TRUCK A9500</b> All Models with Hendrickson 40LH Model Tandem Axle	
R	99-01	A9513 All Models with Hendrickson 40LH Model Tandem Axle	
R	99	A9522 All Models with Hendrickson 40LH Model Tandem Axle	
R	99-10	L9500 All Models with Hendrickson 40LH Model Tandem Axle	
R	99-00	L9501 All Models with Hendrickson 40LH Model Tandem Axle	
R	99-01	L9511 All Models with Hendrickson 40LH Model Tandem Axle	
R	99-00	L9513 All Models with Hendrickson 40LH Model Tandem Axle	
R	99	L9522 All Models with Hendrickson 40LH Model Tandem Axle	
<b>83110</b>	W		145128 (1)
R		<b>MACK</b> ADDITIONAL APPLICATIONS	
R	89-05	CH All CH600 Models with Hendrickson HAS-40LH Air Suspension (O.E. Number 57241-4)	
R	98-05	CX All Models with Hendrickson HAS-40LH Air Suspension (O.E. Number 57241-4)	
<b>83111</b>	D		145128 (1)
R		<b>HENDRICKSON TRUCK SUSPENSION SYSTEMS</b> ADDITIONAL APPLICATIONS	
R		HAS - SERIES	
R		<b>MACK</b> ADDITIONAL APPLICATIONS	
R	89-05	CH All CH600 Models with ALV Hendrickson Suspension	
R	89-05	CH All CH600 Models with Hendrickson AL-405 Rear Suspension	
R	91-07	CL All CL600, CL700 Models with ALV Hendrickson Suspension	
R	98-05	CX All Models with ALV Hendrickson Suspension	
R	98-05	CX All Models with MAC AL405 Suspension	
R		<b>WESTERN STAR</b> 4800 & 4900 SERIES	
R		5900 & 6900 SERIES - HERITAGE CLASS	
<b>83112</b>	C		145128 (1)
R		<b>ADVANCE MIXER</b> VARIOUS	
R	24	<b>AUTOCAR LLC.</b> DC-64	
R	20-23	DC-64 All Models with Hendrickson HN - 522	
R	08-23	XPEDITOR All 6 X 4 Models with Hendrickson HN - 522	
R	10-23	XSPOTTER OFF ROAD All 6 X 4 Off-Road Terminal Tractors with Hendrickson HN - 462	
R	21-23	<b>DENNIS EAGLE</b> PROVIEW All Models with Hendrickson HN-460 Rear Suspension	
R	17	PROVIEW All Models with Hendrickson HN-460 Rear Suspension	
R		<b>HENDRICKSON TRUCK SUSPENSION SYSTEMS</b> HN - SERIES	
R	96-15	HN - SERIES	
R	99-14	<b>INTERNATIONAL</b> 5600I All Models with Hendrickson HN - 402 Rear Suspension	
R	08-22	<b>WORKSTAR</b> 7600 All Models with Hendrickson HN - 522 Rear Suspension	
R	18-23	<b>MACK ANTHEM</b> All Models with Hendrickson HN - 522 Rear Suspension	
R	89-05	CH All CH600 Models with Hendrickson HN-2 Series Suspension	
R	91-07	CL All CL600, CL700 Models with Hendrickson HN-2 Series Suspension	
R	01-08	CV All CV-713 Models with Hendrickson HN-2 Models Suspension	
R	98-05	CX All Models with Hendrickson HN-2 Series Suspension	
R	18-20	<b>GRANITE</b> All Granite 64BR & 64FR Models with Hendrickson HN - 462	

# Numerical listing

Shock	POP	Alternative No.	MTG Acc. Supplied
Pos.	Year	Application	
<b>83112</b>	C (cont)		145128 (1)
R		<b>MC NEILUS TRUCK &amp; MAN.</b> VARIOUS	
R	08-19	<b>PETERBILT</b> 389 All Models with Hendrickson HN - 522 Rear Suspension	
R		<b>VOLVO</b> ADDITIONAL APPLICATIONS	
R	97-01	WG All Models with Hendrickson HN - 402 or HN - 462 Rear Suspension	
R	96	WG All Models with Hendrickson HN - 402 Rear Suspension	
R	96-04	WX All Models with Hendrickson HN - 402 Rear Suspension	
R	96-03	WXL	
R	96-03	WXR	
R	12-22	<b>WESTERN STAR</b> 4700SB All Models with Hendrickson HN - 462	
R	12-22	4700SF All Models with Hendrickson HN - 462	
<b>83113</b>	W		
R		<b>SAF HOLLAND</b> TRAILER AIR SUSPENSION	
R		<b>STOUGHTON TRAILERS INC.</b> VARIOUS	
R		<b>TRAILMOBILE CANADA CORP.</b> VARIOUS	
R		<b>WABASH NATIONAL</b> VARIOUS	
<b>83114</b>	W		140780 (1)
F		<b>INTERNATIONAL</b> SERIES 400, 500, 600, 700 & 900-MED CABOV TRK&TRAC NISS	
F		UNISTAR	
<b>83119</b>	W		
F		<b>FREIGHTLINER</b> VARIOUS	
F		<b>OSHKOSH MOTOR TRUCK CO.</b> VARIOUS	
<b>83120</b>	W		145089-000(1)/145143(1)
R	05-22	<b>FREIGHTLINER B2</b> All Models with 15,000 lb Rear Suspension	
R	97-08	BUS CHASSIS	
R	91-06	FL70 All w/ 15000 lb Rear Suspension	
R	91-06	FL80 All w/ 15000 lb Rear Suspension	
R	96-99	MC CHASSIS	
R		VARIOUS	
R		<b>OSHKOSH MOTOR TRUCK CO.</b> VARIOUS	
R	10	<b>STERLING TRUCK</b> ACTERRA All Models with 15000 lb Rear Suspension	
R	08	ACTERRA All Models with 15000 lb Rear Suspension	
R	03-06	ACTERRA All Models with 15000 lb Rear Suspension	
R	01-07	ACTERRA 5500 All Models with 15000 lb Rear Suspension	
R	02-07	ACTERRA 6500 All Models with 15000 lb Rear Suspension	
R	01-07	ACTERRA 7500 All Models with 15000 lb Rear Suspension	
R	01-03	ACTERRA 8500 All Models with 15000 lb Rear Suspension	
R	05-22	<b>THOMAS</b> VARIOUS	
R		<b>UPS TRUCK</b> VARIOUS	
<b>83122</b>	W		
R		<b>ALLCO TRAILER</b> VARIOUS	
F		<b>AUTOCAR LLC.</b> ADDITIONAL APPLICATIONS	
R	97-09	<b>CHEVROLET</b> C6500 KODIAK All Models with Hendrickson Air Suspension (Stamping number 47902-13)	
R	02-09	C7500 KODIAK All Models with Hendrickson Air Suspension (Stamping number 47902-13)	
R	97-99	C7500 KODIAK All Models with Hendrickson Air Suspension (Stamping number 47902-13)	
R	03-09	C8500 All Models with Hendrickson Air Suspension (Stamping number 47902-13)	
R	99	T7500 All Models with Hendrickson Air Suspension (Stamping number 47902-13)	
R	04-09	T8500 All Models with Hendrickson Air Suspension (Stamping number 47902-13)	



# Numerical listing

Shock	POP	Alternative No.	MTG Acc. Supplied
Pos.	Year	Application	
<b>83122</b>		W (cont)	
R	09	<b>COACHMEN</b>	AURORA
R	07		AURORA
R	99-07		MIRADA
R	04-12		PURSUIT
R	00-14	<b>DAMON</b>	CHALLENGER All MotorHomes with Ford F53 Chassis with 16,000 lb GVW to 22,000 lb GVW
R	12-13		DAYBREAK
R	99		DAYBREAK
R	00-11		DAYBREAK All MotorHomes with Ford F53 Chassis with 16,000 lb GVW to 22,000 lb GVW
R	99		INTRUDER
R	00-07		INTRUDER All MotorHomes with Ford F53 Chassis with 16,000 lb GVW to 22,000 lb GVW
R	12-14		OUTLAW
R	07-11		OUTLAW All MotorHomes with Ford F53 Chassis with 16,000 lb GVW to 22,000 lb GVW
R	19-24	<b>ENTEGR</b>	<b>COACH EMBLEM</b> All MotorHomes with Ford F53 Chassis with 16,000 lb GVW to 22,000 lb GVW
R	19-24		VISION All MotorHomes with Ford F53 Chassis with 16,000 lb GVW to 22,000 lb GVW
R	19-20	<b>FLEETWOOD</b>	AXON
R	18		AXON All MotorHomes with Ford F53 Chassis with 16,000 lb GVW to 22,000 lb GVW
R	00-24		BOUNDER All MotorHomes with Ford F53 Chassis with 16,000 lb GVW to 22,000 lb GVW
R	15-24		FLAIR All MotorHomes with Ford F53 Chassis with 16,000 lb GVW to 22,000 lb GVW
R	00-07		FLAIR All MotorHomes with Ford F53 Chassis with 16,000 lb GVW to 22,000 lb GVW
R	23-24		FLEX All MotorHomes with Ford F53 Chassis with 16,000 lb GVW to 22,000 lb GVW
R	20-24		FORTIS All MotorHomes with Ford F53 Chassis with 16,000 lb GVW to 22,000 lb GVW
R	00-23		SOUTHWIND All MotorHomes with Ford F53 Chassis with 16,000 lb GVW to 22,000 lb GVW
R	11-18		STORM All MotorHomes with Ford F53 Chassis with 16,000 lb GVW to 22,000 lb GVW
R	01-07		STORM All MotorHomes with Ford F53 Chassis with 16,000 lb GVW to 22,000 lb GVW
R			<b>FORD CL &amp; CLT SERIES - HIGHWAY TRACTOR TILT CAB</b>
R	06-23		F-53
R	99-04		F-53
R	06-23		F-53 MOTORHOME CHASSIS All Motorhome Chassis with 16,000 lb GVW to 18,000 lb GVW
R	06-23		F-53 MOTORHOME CHASSIS All Motorhome Chassis with 20,500 lb GVW to 22,000 lb GVW
R	99-04		F-53 MOTORHOME CHASSIS All Motorhome Chassis with 16,000 lb GVW to 18,000 lb GVW
R	99-04		F-53 MOTORHOME CHASSIS All Motorhome Chassis with 20,500 lb GVW to 22,000 lb GVW
R	88-97		F-53 MOTORHOME CHASSIS All Motorhome Chassis with 16,000 lb GVW to 18,000 lb GVW
R			L, LT & LTS - CONVENTIONAL CAB
R			LN & LNT - CONVENTIONAL CAB
R			<b>FRUEHAUF</b> VARIOUS
R	99-09		<b>GEORGIE BOY MANUFACTURING</b> CLASS A MOTORHOMES
F			<b>GILLIG</b> VARIOUS
R			VARIOUS
R	95-02		<b>GMC C - SERIES</b> (C6500, C7500, C8500) TOPKICK
R	99		T5500
R	99		T7500 All Models with Hendrickson Air Suspension (Stamping number 47902-13)
R	99		T8500
R			<b>GREAT DANE TRAILER</b> VARIOUS
R			<b>HENDRICKSON TRUCK</b>
R			<b>SUSPENSION SYSTEMS</b> HA - SERIES
R	11-15		<b>HOLIDAY RAMBLER</b> ADMIRAL

# 83000 Series

Shock	POP	Alternative No.	MTG Acc. Supplied
Pos.	Year	Application	
<b>83122</b>		W (cont)	
R	02-06		ADMIRAL
R	15		ENDEAVOR
R	10		VACATIONER
R	08		VACATIONER
R			<b>ISUZU</b> FVR
R	99-15		<b>ITASCA</b> CLASS A MOTORHOMES
F			<b>LODAL INC.</b> VARIOUS
R			<b>MC NEILUS TRUCK &amp; MAN.</b> VARIOUS
R	12-13		<b>MONACO COACH</b> LA PALMA All MotorHomes with Ford F53 Chassis with 16,000 lb GVW to 22,000 lb GVW
R	09		LA PALMA All MotorHomes with Ford F53 Chassis with 16,000 lb GVW to 22,000 lb GVW
R	02-06		LA PALMA All MotorHomes with Ford F53 Chassis with 16,000 lb GVW to 22,000 lb GVW
R	00		LA PALMA All MotorHomes with Ford F53 Chassis with 16,000 lb GVW to 22,000 lb GVW
R	06-14		MONARCH All MotorHomes with Ford F53 Chassis with 16,000 lb GVW to 22,000 lb GVW
R	01-02		MONARCH All MotorHomes with Ford F53 Chassis with 16,000 lb GVW to 22,000 lb GVW
R	99-08		<b>NATIONAL RV</b> CLASS A MOTORHOMES
R	13-20		<b>NEWMAR</b> CLASS A MOTORHOMES
F			<b>OSHKOSH MOTOR TRUCK CO.</b> VARIOUS
F			<b>REYCO</b> SUSPENSION STEER AXLE
R			TRAILER
R			<b>SAF HOLLAND TRUCK &amp; TRACTOR</b> AIR SUSPENSION (TAG AXLE)
R	05-08		<b>THOR MOTOR COACH</b> CHALLENGER
R	04-10		HURRICANE
R	07-10		OUTLAW
R	06-10		WINDSPORT
F			<b>TUTHILL TECHNOLOGIIES</b> STEER AXLE
R			TRAILER
F			<b>VOLVO</b> ADDITIONAL APPLICATIONS
R	78-83		ADDITIONAL APPLICATIONS
R	98		<b>WESTERN STAR</b> 3800
R	86-88		3800
R	99-01		3800 All Models with Hendrickson Air Suspension
R	89-97		3800 All Models with Hendrickson Air Suspension
R	89-02		4800 All Models with Hendrickson Air Suspension
R	89-02		4900 All Models with Hendrickson Air Suspension
R	97-02		5800 All Models with Hendrickson Air Suspension
R	89-01		5900 All Models with Hendrickson Air Suspension
R	89-01		6900 All Models with Hendrickson Air Suspension
R	23		<b>WINNEBAGO</b> SUNSTAR NPF
R	23		VISTA NPF
<b>83123</b>		C	
R	81-91		<b>FORD</b> CL9000 All Models with Rear Tandem Axle with Neway Suspension
R	78-80		CL & CLT SERIES - HIGHWAY TRACTOR TILT CAB
R	81-91		CLT9000 All Models with Rear Tandem Axle with Neway Suspension
R	00-03		F-650 All Models with Hendrickson HAS - 190 Rear Air Suspension
R	00-03		F-750 All Models with Hendrickson HAS - 190 Rear Air Suspension
R			<b>GILLIG</b> VARIOUS
R			<b>HENDRICKSON TRUCK</b>
R			<b>SUSPENSION SYSTEMS</b> HA - SERIES
R			HAS - SERIES
R	03-18		<b>IC CORPORATION</b> RE SCHOOL BUS All RE Model School Buses (Low Profile)
R			<b>INTERNATIONAL</b> F & S SERIES
R			SERIES 3000 - SCHOOL BUS CHASSIS

# Numerical listing

Shock	POP	Alternative No.	MTG Acc. Supplied
Pos.	Year	Application	
<b>83123</b>		C (cont)	
R			SERIES 9600 & 9700 PREMIUM CABOVER TRACTOR
R			S SERIES SCHOOL BUS
R	93-05		<b>KENWORTH</b> K300 All Models with Hendrickson Rear Air Suspension
R	13-24		K370 All Models with Hendrickson HAS - 210L or HAS - 230L Rear Air Suspension
R	21-24		T280 All Models with Hendrickson HAS - 210L or HAS - 230L Rear Air Suspension
R			T300
R	01-08		T300 All Models with Hendrickson HAS - 210L or HAS - 230L Rear Air Suspension
R	95-99		T300 All Models with Hendrickson HAS - 210L or HAS - 230L Rear Air Suspension
R	08-23		T370 All Models with Hendrickson HAS - 210L or HAS - 230L Rear Air Suspension
R	22-24		T380 All Models with Hendrickson HAS - 210L or HAS - 230L Rear Air Suspension
R	93-08		T600A All Models with Hendrickson HAS - 210L or HAS - 230L Rear Air Suspension
R	93-24		T800 All Models with Hendrickson HAS - 210L or HAS - 230L Rear Air Suspension
R	93-24		W900 All Models with Hendrickson HAS - 210L or HAS - 230L Rear Air Suspension
R	89-05		<b>MACK</b> CH All CH600 Models with Hendrickson Rear Air Suspension
R	91-07		CL All CL600, CL700 Models with Hendrickson Rear Air Suspension
R	83-94		MH All MH Models with Neway ARD-234 Air Suspension
R	85-93		RW All RW Models with Neway ARD-234 Air Suspension
R			<b>MC NEILUS TRUCK &amp; MAN.</b> VARIOUS
R	13-24		<b>PETERBILT</b> 220 All Models with Hendrickson HAS - 210L or HAS - 230L Rear Air Suspension
R	10		220 All Models with Hendrickson HAS - 210L or HAS - 230L Rear Air Suspension
R	07		220 All Models with Hendrickson HAS - 210L or HAS - 230L Rear Air Suspension
R			<b>REYCO</b> SUSPENSION DRIVE AXLE
R			TRAILER
R			<b>SAF HOLLAND</b> TRAILER AIR SUSPENSION
R			TRUCK, BUS & MOTORHOME AIR SUSPENSIONS
R			TRUCK & TRACTOR AIR SUSPENSION (TAG AXLE)
R			<b>TUTHILL TECHNOLOGIIES</b> DRIVE AXLE
R			<b>WATSON &amp; CHALIN MFG. INC.</b> WCTA SERIES DUMP TRAILER AIR SUSPENSION
<b>83124</b>		C	
R			<b>BENSON TRUCK BODIES INC.</b> VARIOUS
F			<b>BLUE BIRD</b> ALL AMERICAN SERIES (FE & RE MODELS)
F	10-13		D3 SERIES (FE & RE MODELS)
F			<b>COACHMEN</b> CLASS A MOTORHOMES
R	00-10		<b>COUNTRY COACH</b> AFFINITY All MotorHomes with Neway IFS
R	00		CONCEPT All MotorHomes with Neway IFS
R	00-04		MAGNA All MotorHomes with Neway IFS
R	05-10		MAGNA 630 All MotorHomes with Neway IFS
R			<b>EAST MANUFACTURING CORP.</b> VARIOUS
F			<b>FOREST RIVER</b> CLASS A MOTORHOMES
F			<b>GEORGIE BOY MANUFACTURING</b> CLASS A MOTORHOMES
F			<b>ITASCA</b> CLASS A MOTORHOMES
F			<b>KENWORTH</b> T800, T800B, T800B(8X4), T800SH, T800H, T800W

Numerical listing

Shock	POP	Alternative No.	MTG Acc. Supplied
Pos.	Year	Application	
<b>83124</b>	C	(cont)	
F		<b>MONACO COACH CLASS A MOTORHOMES</b>	
R		<b>SAF HOLLAND TRAILER AIR SUSPENSION</b>	
R		TRUCK & TRACTOR AIR SUSPENSION (TAG AXLE)	
R		<b>TRAILMOBILE CANADA CORP. VARIOUS</b>	
R		<b>TWIN COACH VARIOUS</b>	
R		<b>WABASH NATIONAL VARIOUS</b>	
F		<b>WORKHORSE VARIOUS</b>	
<b>83125</b>	C		
R		<b>CASCADE TRAILER VARIOUS</b>	
R		<b>EAST MANUFACTURING CORP. VARIOUS</b>	
F	94	<b>FORD B-700</b> All Models with 14600 lb Multileaf Spring	
F	95-98	<b>B-800</b> All Models with 14600 lb Multileaf Spring	
F	88-97	<b>F-53 MOTORHOME CHASSIS</b> All F53 Motorhome Chassis (Over 30 feet)	
F	94	<b>F-700</b> All Models with 14600 lb Multileaf Spring	
F	94	<b>F-800</b> All Models with 14600 lb Multileaf Spring	
F	94-98	<b>FT900</b> All Models with Multileaf Spring and 14600 lb Axle	
R		<b>GENERAL TRAILER CO. VARIOUS</b>	
R		<b>HENDRICKSON TRUCK SUSPENSION SYSTEMS HAS - SERIES</b>	
R		<b>HOLLAND-BINKLEY VARIOUS</b>	
R	89-05	<b>MACK CH</b> All CH Models with Hendrickson HA Series Air Suspension	
R	89-05	<b>CH</b> All CH600 Models with HAS400 MACK Air Suspension	
R	91-07	<b>CL</b> All CL600, CL700 Models with HAS400 MACK Air Suspension	
R	91-07	<b>CL</b> All CL600, CL700 Models with Hendrickson HA Series Air Suspension	
R	98-05	<b>CX</b> All Models with HAS400 MACK Air Suspension	
R	98-05	<b>CX</b> All Models with Hendrickson HA Series Air Suspension	
R		<b>PEERLESS TRAILER VARIOUS</b>	
R		<b>SAF HOLLAND TRAILER AIR SUSPENSION</b>	
R		TRUCK & TRACTOR AIR SUSPENSION (TAG AXLE)	
R	97	<b>THE BINKLEY COMPANY VARIOUS</b>	
R		<b>TRAILMOBILE CANADA CORP. VARIOUS</b>	
R		<b>WABASH NATIONAL VARIOUS</b>	
R		<b>WATSON &amp; CHALIN MFG. INC. WCTA SERIES DUMP TRAILER AIR SUSPENSION</b>	
R		<b>WCTA SERIES TRAILER AIR SUSPENSION</b>	
R		<b>WCTL-2200 SERIES TRAILER AIR LIFT</b>	
R		<b>WCWB SERIES TRAILER AIR SUSPENSION</b>	
<b>83126</b>	D		
R	71-89	<b>CHEVROLET 6, 60, 6000 &amp; 6500 SERIES</b>	
F	73-80	<b>6, 60, 6000 &amp; 6500 SERIES</b>	
F	68-69	<b>6, 60, 6000 &amp; 6500 SERIES</b>	
R	79-89	<b>7, 70 &amp; 7000 SERIES</b>	
F	66-80	<b>7, 70 &amp; 7000 SERIES</b>	
R	05-06	<b>FREIGHTLINER M2 106</b> All Models with Reyco 79KB Rear Steel Spring Suspension	
R	02-03	<b>M2 106</b> All Models with Reyco 79KB Rear Steel Spring Suspension	
F	79-80	<b>GMC 6000 SERIES</b>	
F	66-80	<b>6500 SERIES</b>	
R	66-80	<b>6500 SERIES</b>	
R	79-89	<b>7000 SERIES</b>	
F	79-80	<b>7000 SERIES</b>	
F	66-80	<b>7500 SERIES</b>	
R	00-09	<b>INTERNATIONAL 5900I</b> All Models with 46,000 lb Neway Rear Air Suspension	
R		<b>SERIES 5000, 5000I -SEVERE SERVICE CONV TRK &amp; TRAC</b>	
R		<b>SERIES 8000 - CONVENTIONAL HEAVY DUTY TRACTOR</b>	

83000 Series

Shock	POP	Alternative No.	MTG Acc. Supplied
Pos.	Year	Application	
<b>83126</b>	D	(cont)	
R		<b>SERIES 9100, 9100I - TRACTOR &amp; STRAIGHT TRUCK</b>	
R		<b>SERIES 9200, 9200I - TRACTOR &amp; STRAIGHT TRUCK</b>	
R		<b>SERIES 9300, 9300I, 9400 &amp; 9400I LONG HOOD CONV.</b>	
R		<b>SERIES 9800 - PREMIUM CABOVER TRACTOR</b>	
R		<b>SERIES 9900, 9900I, 9900IX LONG HOOD CONV. TRUCK</b>	
R	93-05	<b>KENWORTH K300</b> All Models with Reyco 102 or 79KB Suspension (Drive Axle)	
F	93-05	<b>K300</b> All Models with Reyco 1209 or 1212 Suspension (Steer Axle)	
R	13-24	<b>K370</b> All Models with Reyco 102 or 79KB Suspension (Drive Axle)	
F		<b>T300</b>	
R		<b>T300</b>	
R	01-08	<b>T300</b> All Models with Reyco 102 or 79KB Suspension (Drive Axle)	
R	01-08	<b>T300</b> All Models with Reyco 1209 or 1212 Suspension (Steer Axle)	
R	99	<b>T300</b> All Models with Reyco 102 or 79KB Suspension (Drive Axle)	
R	99	<b>T300</b> All Models with Reyco 1209 or 1212 Suspension (Steer Axle)	
R	08-23	<b>T370</b> All Models with Reyco 102 or 79KB Suspension (Drive Axle)	
R	22-24	<b>T380</b> All Models with Reyco 102 or 79KB Suspension (Drive Axle)	
R	12-21	<b>T440</b>	
R	10-21	<b>T470</b>	
F		<b>T600, T600A, T600B, T602</b>	
R		<b>T600, T600A, T600B, T602</b>	
R	11-23	<b>T680</b> All Models with Reyco 102 or 79KB Suspension (Drive Axle)	
R	87-24	<b>T800</b> All Models with Reyco 102 or 79KB Suspension (Drive Axle)	
F	87-23	<b>T800</b> All Models with Reyco 1209 or 1212 Suspension (Steer Axle)	
R	11-22	<b>T880</b> All Models with Reyco 102 or 79KB Suspension (Drive Axle)	
R	06-22	<b>W900</b> All Models with Reyco 102 or 79KB Suspension (Drive Axle)	
F		<b>W900, W900B, W900L, W900S</b>	
R		<b>W900, W900B, W900L, W900S</b>	
R	19-22	<b>W990</b> All Models with Reyco 102 or 79KB Suspension (Drive Axle)	
R	13-24	<b>PETERBILT 220</b> All Models with Reyco 102 or 79KB Suspension (Drive Axle)	
R	10	<b>220</b> All Models with Reyco 102 or 79KB Suspension (Drive Axle)	
R	07	<b>220</b> All Models with Reyco 102 or 79KB Suspension (Drive Axle)	
R	87-18	<b>320</b> All Models with Reyco 102 or 79KB Suspension (Drive Axle)	
R	07-22	<b>330</b> All Models with Reyco 79KB Rear Steel Spring Suspension	
R	95-05	<b>330</b> All Models with Reyco 79KB Rear Steel Spring Suspension	
R	10-22	<b>337</b> All Models with Reyco 79KB Rear Steel Spring Suspension	
R	10-23	<b>348</b> All Models with Reyco 79KB Rear Steel Spring Suspension	
R	10-22	<b>365</b> All Models with Reyco 79KB Rear Steel Spring Suspension	
R	11-17	<b>382</b> All Models with Reyco 79KB Rear Steel Spring Suspension	
R	17-22	<b>520</b> All Models with Reyco 79KB Rear Steel Spring Suspension	
R	22-24	<b>537</b> All Models with Reyco 102 or 79KB Suspension (Drive Axle)	
R	13-24	<b>579</b> All Models with Reyco 79KB Rear Steel Spring Suspension	
R	11-18	<b>587</b> All Models with Reyco 79KB Rear Steel Spring Suspension	
R		<b>REYCO SUSPENSION DRIVE AXLE</b>	
F		<b>STEER AXLE</b>	
R		<b>SAF HOLLAND TRAILER AIR SUSPENSION</b>	
F	96-00	<b>SAFARI MOTOR COACH CLASS A MOTORHOMES</b>	
R	96-00	<b>CLASS A MOTORHOMES</b>	
R		<b>TUTHILL TECHNOLOGIIES DRIVE AXLE</b>	
F		<b>STEER AXLE</b>	
R		<b>WABASH NATIONAL VARIOUS</b>	
R	12-22	<b>WESTERN STAR 4700SB</b> All Models with Reyco 102 or 79KB Suspension (Drive Axle)	

Numerical listing

Shock	POP	Alternative No.	MTG Acc. Supplied
Pos.	Year	Application	
<b>83126</b>	D	(cont)	
R	12-22	<b>4700SF</b> All Models with Reyco 102 or 79KB Suspension (Drive Axle)	
<b>83127</b>	C		
R		<b>BLUE BIRD ADDITIONAL APPLICATIONS</b>	
F		<b>FREIGHTLINER VARIOUS</b>	
R		<b>HOLIDAY RAMBLER VARIOUS</b>	
F	21-24	<b>MACK MD7</b> All Models with 12,000 lb Taperleaf Springs	
R		<b>MC NEILUS TRUCK &amp; MAN. VARIOUS</b>	
F		<b>OSHKOSH MOTOR TRUCK CO. VARIOUS</b>	
R		<b>SAF HOLLAND TRAILER AIR SUSPENSION</b>	
R		TRUCK, BUS & MOTORHOME AIR SUSPENSIONS	
R		TRUCK & TRACTOR AIR SUSPENSION (TAG AXLE)	
R		<b>TRAILMOBILE CANADA CORP. VARIOUS</b>	
R		<b>WABASH NATIONAL VARIOUS</b>	
<b>83128</b>	A		
R		<b>EAST MANUFACTURING CORP. VARIOUS</b>	
R	89-99	<b>FREIGHTLINER FLA086</b> All Models with Neway Tag Axle Air Suspension	
R	02	<b>FLB</b> All Models with Neway Tag Axle Air Suspension	
R	94-99	<b>FLB</b> All Models with Neway Tag Axle Air Suspension	
R		<b>MC NEILUS TRUCK &amp; MAN. VARIOUS</b>	
R		<b>REYCO SUSPENSION TRAILER</b>	
R		<b>SAF HOLLAND TRAILER AIR SUSPENSION</b>	
R		TRUCK, BUS & MOTORHOME AIR SUSPENSIONS	
R		<b>STOUGHTON TRAILERS INC. VARIOUS</b>	
R		<b>TWIN COACH VARIOUS</b>	
R		<b>WABASH NATIONAL VARIOUS</b>	
<b>83130</b>	C		
R		<b>RIDEWELL CORP. TRUCK AIR-RIDES</b>	
R		<b>SAF HOLLAND TRAILER AIR SUSPENSION</b>	
R		<b>WABASH NATIONAL VARIOUS</b>	
<b>83131</b>	W		
F	00-02	<b>FORD F-650</b> All Models with 8500 or 9000 lb Front Axle	
F	00-02	<b>F-750</b> All Models with 8500 or 9000 lb Front Axle	
<b>83134</b>	W	<b>145054 (1)</b>	
R	05-21	<b>FREIGHTLINER M2</b> All Models with Rear 52" Spring ,10000 lb - 15000 lb	
R	05-21	<b>M2</b> All Models with Rear 52" Spring ,18000 lb - 23000 lb	
R	02-10	<b>M2 100</b> All Models with Rear 52" Spring ,10000 lb - 15000 lb	
R	02-10	<b>M2 100</b> All Models with Rear 52" Spring ,18000 lb - 23000 lb	
R	05-06	<b>M2 106</b> All Models with Rear 52" Spring ,10000 lb - 15000 lb	
R	05-06	<b>M2 106</b> All Models with Rear 52" Spring ,18000 lb - 23000 lb	
R	02-03	<b>M2 106</b> All Models with Rear 52" Spring ,10000 lb - 15000 lb	
R	02-03	<b>M2 106</b> All Models with Rear 52" Spring ,18000 lb - 23000 lb	
R	03-23	<b>M2 112</b> All Models with Rear 52" Spring ,10000 lb - 15000 lb	
R	03-23	<b>M2 112</b> All Models with Rear 52" Spring ,18000 lb - 23000 lb	
<b>83135</b>	C		
F	14	<b>FORD F-650</b>	
F	15	<b>F-650</b> All Models with 8,500 lb Front Suspension	
F	00-13	<b>F-650</b> All Models with 8,500 lb Front Suspension	
F	14	<b>F-750</b>	
F	15	<b>F-750</b> All Models with 8,500 lb Front Suspension	
F	00-13	<b>F-750</b> All Models with 8,500 lb Front Suspension	
F		<b>IC CORPORATION AE SCHOOL BUS</b>	

## Numerical listing

Shock	POP	Alternative No.	MTG Acc. Supplied
Pos.	Year	Application	
<b>83135</b>		C (cont)	
F	20	<b>INTERNATIONAL</b>	4300 All Models with 6,000 to 8,000 lb Front Suspension
F	15	4300	All Models with 6,000 to 8,000 lb Front Suspension
F	02-20	4400	All Models with 6,000 to 8,000 lb Front Suspension
F	02-20	7400	All Models with O.E.M. Number
F	10-12	<b>DURASTAR</b>	- 4300, 4400 SERIES
F		<b>SERIES 3000 - SCHOOL BUS CHASSIS</b>	
F	15-20	<b>WORKSTAR</b>	7400 All Models with O.E.M. Number
F	10-19	<b>WORKSTAR</b>	- 7000 SERIES
<b>83136</b>		W	145054 (2)
F		<b>CHAMPION BUS INC. VARIOUS</b>	
F		<b>CHEVROLET B - SERIES - SCHOOL BUS</b>	
F	90-96	C70 KODIAK	All Conventional Cab w/ Front Shock with O.E.M. Number
R	90-96	C70 KODIAK	All Conventional Cab w/19000, 21000, 23000 lb Taperleaf Springs (EXC Low Profile Vehicle)
F	90-02	C4500 KODIAK	
R	90-02	C4500 KODIAK	
F	92-02	C5500 KODIAK	
R	92-02	C5500 KODIAK	
F	97-09	C6500 KODIAK	All Conventional Cab w/ Front Shock with O.E.M. Number
R	97-09	C6500 KODIAK	All Conventional Cab w/19000, 21000, 23000 lb Taperleaf Springs (EXC Low Profile Vehicle)
F	02-09	C7500 KODIAK	All Conventional Cab w/ Front Shock with O.E.M. Number
R	02-09	C7500 KODIAK	All Conventional Cab w/19000, 21000, 23000 lb Taperleaf Springs (EXC Low Profile Vehicle)
F	97-99	C7500 KODIAK	All Conventional Cab w/ Front Shock with O.E.M. Number
R	97-99	C7500 KODIAK	All Conventional Cab w/19000, 21000, 23000 lb Taperleaf Springs (EXC Low Profile Vehicle)
F		C - SERIES (C6500, C7500, C8500) KODIAK	
F	97-09	T5500	
R	92-99	T5500	
F	03	T6500	
R	92-96	T6500	
F	03	T7500	
R	92-96	T7500	
F	04-09	T7500	All FL1 Tilt Cab with 8100 lb Axle
F	04-09	T7500	All FL2 Tilt Cab with 5000 to 11000 lb Axle
F	04-09	T7500	All FL3 Tilt Cab with 14575 lb Axle
F	97-02	T7500	All FL1 Tilt Cab with 8100 lb Axle
F	97-02	T7500	All FL2 Tilt Cab with 5000 to 11000 lb Axle
F	97-02	T7500	All FL3 Tilt Cab with 14575 lb Axle
R	97-99	T7500	All Tilt Cab w/19000, 21000, 23000 lb Taperleaf Springs (EXC Low Profile Veh.)
F	98-03	T8500	
R	98-99	T8500	
F	04-09	T8500	All FL1 Tilt Cab with 8100 lb Axle
F	04-09	T8500	All FL2 Tilt Cab with 5000 to 11000 lb Axle
F	04-09	T8500	All FL3 Tilt Cab with 14575 lb Axle
F	93-02	<b>GMC B7</b>	All Models with O.E.M. Number
F	90-02	C4500 TOPKICK	
R	90-02	C4500 TOPKICK	
F	90-02	C5500 TOPKICK	
R	90-02	C5500 TOPKICK	
F	90-09	C - SERIES (C6500, C7500, C8500) TOPKICK	
R	90-09	C - SERIES (C6500, C7500, C8500) TOPKICK	
F	97-09	T5500	
R	92-99	T5500	
F	03	T6500	

## 83000 Series

Shock	POP	Alternative No.	MTG Acc. Supplied
Pos.	Year	Application	
<b>83136</b>		W (cont)	145054 (2)
R	92-96	T6500	
F	03	T7500	
R	92-96	T7500	
F	04-09	T7500	All FL1 Tilt Cab with 8100 lb Axle
F	04-09	T7500	All FL2 Tilt Cab with 5000 to 11000 lb Axle
F	04-09	T7500	All FL3 Tilt Cab with 14575 lb Axle
F	97-02	T7500	All FL1 Tilt Cab with 8100 lb Axle
F	97-02	T7500	All FL2 Tilt Cab with 5000 to 11000 lb Axle
F	97-02	T7500	All FL3 Tilt Cab with 14575 lb Axle
R	97-99	T7500	All Tilt Cab with 19000, 21000, 23000 lb Taperleaf Springs (EXC Low Profile Veh.)
F	97-09	T8500	
R	92-99	T8500	
F	04-07	<b>GULF STREAM</b>	ENDURA
R	00-02	<b>ISUZU FSR</b>	All Models with 19000, 21000, 23000 lb Taperleaf Springs (EXC Low Profile Veh.)
F	00-02	FSR	All Models with FL1 Tilt Cab with 8100 lb Axle (Including Low Profile)
R	97-09	FVR	All Models with 19000, 21000, 23000 lb Taperleaf Springs (EXC Low Profile Veh.)
F	97-09	FVR	All Models with O.E.M. Number
R	93-05	<b>KENWORTH K300</b>	All Models with Woodhead Shock (Stamping Number ACHB 966) T300
R		<b>PETERBILT</b>	270
<b>83137</b>		W	
R	14-24	<b>AUTOCAR LLC. XPERT</b>	All Models with Hendrickson HAS-210 or HAS-230 Air Suspensions
R	12	XPERT	All Models with Hendrickson HAS-210 or HAS-230 Air Suspensions
R		<b>BERING</b>	VARIOUS
R	00-22	<b>BLUE BIRD</b>	ALL AMERICAN FE All Models with Hendrickson HAS-210 or HAS-230 Air Suspensions
R	00-22	ALL AMERICAN RE	All Models with Hendrickson HAS-210 or HAS-230 Air Suspensions
R	16-17	<b>CATERPILLAR CT680</b>	All Models HAS-402 Hendrickson Air Suspensions
R	00-02	<b>CHEVROLET C6500 KODIAK</b>	All Models with Hendrickson Air Suspension with O.E.M. Number
R	02-09	C7500 KODIAK	All Models with Hendrickson Air Suspension with O.E.M. Number
R	03-09	C8500	All Models with Hendrickson Air Suspension with O.E.M. Number
R		<b>HENDRICKSON TRUCK SUSPENSION SYSTEMS</b>	HAS - SERIES
R	00-11	<b>ISUZU FVR</b>	All Models with Hendrickson HAS suspension
R	08-14	<b>KENWORTH T370</b>	All Models with Hendrickson HAS - 400 (Standard) Rear Air Suspension
R	22-24	T380	All Models with Hendrickson HAS - 230 Rear Air Suspension
R	12-17	T440	
R	10-16	T470	
R		T600, T600A, T600B, T602	
R		T800, T800B, T800B(8X4), T800SH, T800H, T800W	
R		W900, W900B, W900L, W900S	
R	89-05	<b>MACK CH</b>	All CH Models with Hendrickson HA Series Air Suspension
R	91-07	CL	All CL600, CL700 Models with Hendrickson HA Series Air Suspension
R	98-05	CX	All Models with Hendrickson HA Series Air Suspension
R		<b>MC NEILUS TRUCK &amp; MAN. VARIOUS</b>	
R		<b>SAF HOLLAND TRUCK &amp; TRACTOR AIR SUSPENSION (TAG AXLE)</b>	

## Numerical listing

Shock	POP	Alternative No.	MTG Acc. Supplied
Pos.	Year	Application	
<b>83137</b>		W (cont)	
R		<b>VOLVO</b>	VOCATIONAL TRUCKS
<b>83140</b>		D	415010-802(2)/145148(2)
R	00-03	<b>FORD F-650</b>	All Models with 23,000 lb Multi-leaf Rear Springs
R	00-03	F-750	All Models with 23,000 lb Multi-leaf Rear Springs
F	05-08	<b>HINO 308</b>	All Models with O.E.M. Number
F	05-14	338	All Models with O.E.M. Number
F	08-14	358	All Models with O.E.M. Number
<b>83141</b>		W	415010-802(2)/145148(2)
F	03	<b>HINO FF3020</b>	
F	98-02	FF3020	All FF Models Trucks with O.E.M. Number
F	86-91	SG19	All SG19
F	92	SG20	All SG20
F	86	SG22	All SG22 Straight Truck
F	87-92	SG23	All SG23 Straight Truck
F	89-92	SG231	All SG231 Tractor
F	98-02	SG3320	All SG Models Trucks with O.E.M. Number
F	93-97	SG3320	All SG3320 (SG4H)
F	93-97	SG3323	All SG3323 (SG1H) Straight Truck
F	93-96	SG5523	All SG5523 (SG1HD) Tractor
F	86	SG SERIES	
<b>83142</b>		C	145128 (1)
R	24	<b>AUTOCAR LLC. DC-64</b>	
R	20-23	DC-64	All Models with Hendrickson HMX 400 Haulmax with 17.5" & 18.5" Saddle
R	08-23	XPEDITOR	All 6 X 4 Models with Hendrickson HMX 400/460 Haulmax with 17.5" & 18.5" Saddle
R	13	XPERT	
R	14-23	XPERT	All 6 X 4 Models with Hendrickson HMX 400 Haulmax with 17.5" & 18.5" Saddle
R	12	XPERT	All 6 X 4 Models with Hendrickson HMX 400 Haulmax with 17.5" & 18.5" Saddle
R	11-17	<b>CATERPILLAR CT660</b>	All Models with Hendrickson HMX 400/460 Haulmax with 17.5" & 18.5" Saddle
R	14-17	CT681	All Models with Hendrickson HMX 400/460 Haulmax with 17.5" & 18.5" Saddle
R	12-24	<b>FREIGHTLINER 108SD</b>	All Models with Hendrickson HMX 400/460 Haulmax with 17.5" & 18.5" Saddle
R	12-24	114SD	All Models with Hendrickson HMX 400/460 Haulmax with 17.5" & 18.5" Saddle
R	13-23	122SD	All Models with Hendrickson HMX 400/460 Haulmax with 17.5" & 18.5" Saddle
R	02-07	CONDOR	All Models with Hendrickson HMX 400/460 Haulmax with 17.5" & 18.5" Saddle
R	05-21	M2	All Models with Hendrickson HMX 400/460 Haulmax with 17.5" & 18.5" Saddle
R	02-10	M2 100	All Models with Hendrickson HMX 400/460 Haulmax with 17.5" & 18.5" Saddle
R	05-06	M2 106	All Models with Hendrickson HMX 400/460 Haulmax with 17.5" & 18.5" Saddle
R	02-03	M2 106	All Models with Hendrickson HMX 400/460 Haulmax with 17.5" & 18.5" Saddle
R	03-24	M2 112	All Models with Hendrickson HMX 400/460 Haulmax with 17.5" & 18.5" Saddle
R		<b>HENDRICKSON TRUCK SUSPENSION SYSTEMS</b>	ADDITIONAL APPLICATIONS
R	19-23	<b>INTERNATIONAL HV607</b>	All Models with Hendrickson HMX 400/460 Haulmax with 17.5" & 18.5" Saddle
R	19-23	HV613	All Models with Hendrickson HMX 400/460 Haulmax with 17.5" & 18.5" Saddle
R	17-22	HX515	All Models with Hendrickson HMX 400/460 Haulmax with 17.5" & 18.5" Saddle



# Numerical listing

Shock	POP	Alternative No.	MTG Acc. Supplied
Pos.	Year	Application	
<b>83142</b>	C (cont)	<b>145128 (1)</b>	
R	18-23	HX520 All Models with Hendrickson HMX 400/460 Haulmax with 17.5" & 18.5" Saddle	
R	17-22	HX615 All Models with Hendrickson HMX 400/460 Haulmax with 17.5" & 18.5" Saddle	
R	17-24	HX620 All Models with Hendrickson HMX 400/460 Haulmax with 17.5" & 18.5" Saddle	
R	12-21	<b>KENWORTH T440</b>	
R	10-19	T470	
R	22-24	T480 All Models with Hendrickson HMX 400/460 Haulmax with 17.5" & 18.5" Saddle	
R	11-23	T680 All Models with Hendrickson HMX 400/460 or 520 Haulmax with 17.5" & 18.5" Saddle	
R	01-24	T800 All Models with Hendrickson HMX 400/460 Haulmax with 17.5" & 18.5" Saddle	
R	11-24	T880 All Models with Hendrickson HMX 400/460 or 520 Haulmax with 17.5" & 18.5" Saddle	
R	01-24	W900 All Models with Hendrickson HMX 400/460 Haulmax with 17.5" & 18.5" Saddle	
R	19-24	W990 All Models with Hendrickson HMX 400/460 or 520 Haulmax with 17.5" & 18.5" Saddle	
R	18-24	<b>MACK ANTHEM</b> All Models with Hendrickson HMX 400/460 Haulmax with 17.5" & 18.5" Saddle	
R	01-08	CV All Models with Hendrickson HMX 400/460 Haulmax with 17.5" & 18.5" Saddle	
R	01-14	GRANITE	
R	15-24	GRANITE All Models with Hendrickson HMX 400/460 Haulmax with 17.5" & 18.5" Saddle	
R	10	LE All Models with Hendrickson HMX 400/460 Haulmax with 17.5" & 18.5" Saddle	
R	01-07	LE All Models with Hendrickson HMX 400/460 Haulmax with 17.5" & 18.5" Saddle	
R	08-16	LEU All Models with Hendrickson HMX 400/460 Haulmax with 17.5" & 18.5" Saddle	
R	19-24	LR All Models with Hendrickson HMX 400/460 Haulmax with 17.5" & 18.5" Saddle	
R	01-07	MR All MR600 Models with Hendrickson HMX 400/460 Haulmax with 17.5" or 18.5" Saddle Height	
R		<b>MC NEILUS TRUCK &amp; MAN.</b>	
R		VARIOUS	
R	01-18	<b>PETERBILT 320</b> All Models with Hendrickson HMX 400/460 Haulmax with 17.5" & 18.5" Saddle	
R	10-23	348 All Models with Hendrickson HMX 400/460 Haulmax with 17.5" & 18.5" Saddle	
R	02-08	357 All Models with Hendrickson HMX 400/460 Haulmax with 17.5" & 18.5" Saddle	
R	08-23	365 All Models with Hendrickson HMX 400/460 Haulmax with 17.5" & 18.5" Saddle	
R	08-24	367 All Models with Hendrickson HMX 400/460 Haulmax with 17.5" & 18.5" Saddle	
R	08-15	388 All Models with Hendrickson HMX 400/460 Haulmax with 17.5" & 18.5" Saddle	
R	08-24	389 All Models with Hendrickson HMX 400/460 Haulmax with 17.5" & 18.5" Saddle	
R	17-24	520 All Models with Hendrickson HMX 400/460 Haulmax with 17.5" & 18.5" Saddle	
R	22-24	548 All Models with Hendrickson HMX 400/460 Haulmax with 17.5" & 18.5" Saddle	
R	14-24	567 All Models with Hendrickson HMX 400/460 Haulmax with 17.5" & 18.5" Saddle	
R	19-23	<b>PIERCE MFG. INC.</b> VARIOUS	
R	01-23	<b>VOLVO VHD</b> All Models with Hendrickson HMX 400/460 Haulmax with 17.5" & 18.5" Saddle	
R	22-24	<b>WESTERN STAR 47X</b> All Models with Hendrickson HMX 400/460 Haulmax with 17.5" & 18.5" Saddle	

## 83000 Series

Shock	POP	Alternative No.	MTG Acc. Supplied
Pos.	Year	Application	
<b>83142</b>	C (cont)	<b>145128 (1)</b>	
R	21-24	49X All Models with Hendrickson HMX 400/460 Haulmax with 17.5" & 18.5" Saddle	
R	01-02	4900 All Models with Hendrickson HMX 400/460 Haulmax with 17.5" & 18.5" Saddle	
R	01-02	4900E All Models with Hendrickson HMX 400/460 Haulmax with 17.5" & 18.5" Saddle	
R	02-22	4900EX All Models with Hendrickson HMX 400/460 Haulmax with 17.5" & 18.5" Saddle	
R	02-23	4900FA All Models with Hendrickson HMX 400/460 Haulmax with 17.5" & 18.5" Saddle	
R	02-23	4900SA All Models with Hendrickson HMX 400/460 Haulmax with 17.5" & 18.5" Saddle	
<b>83143</b>	D	<b>145128 (1)</b>	
R	24	<b>AUTOCAR LLC. DC-64</b>	
R	20-23	DC-64 All Models with Hendrickson HMX 400 Haulmax with 16.5" Saddle	
R	08-23	XPEDITOR All 6 X 4 Models with Hendrickson HMX 400/460 Haulmax with 16.5" Saddle	
R	13	XPERT	
R	14-23	XPERT All 6 X 4 Models with Hendrickson HMX 400 Haulmax with 16.5" Saddle	
R	12	XPERT All 6 X 4 Models with Hendrickson HMX 400 Haulmax with 16.5" Saddle	
R	11-17	<b>CATERPILLAR CT660</b> All Models with Hendrickson HMX 400/460 Haulmax with 16.5" Saddle	
R	14-17	CT681 All Models with Hendrickson HMX 400/460 Haulmax with 16.5" Saddle	
R		<b>CRANE CARRIER VARIOUS</b>	
R	12-24	<b>FREIGHTLINER 108SD</b> All Models with Hendrickson HMX 400/460 Haulmax with 16.5" Saddle	
R	12-24	114SD All Models with Hendrickson HMX 400/460 Haulmax with 16.5" Saddle	
R	13-23	122SD All Models with Hendrickson HMX 400/460 Haulmax with 16.5" Saddle	
R	02-07	CONDOR All Models with Hendrickson HMX 400/460 Haulmax with 16.5" Saddle	
R	05-21	M2 All Models with Hendrickson HMX 400/460 Haulmax with 16.5" Saddle	
R	02-10	M2 100 All Models with Hendrickson HMX 400/460 Haulmax with 16.5" Saddle	
R	05-06	M2 106 All Models with Hendrickson HMX 400/460 Haulmax with 16.5" Saddle	
R	02-03	M2 106 All Models with Hendrickson HMX 400/460 Haulmax with 16.5" Saddle	
R	03-24	M2 112 All Models with Hendrickson HMX 400/460 Haulmax with 16.5" Saddle	
R		<b>HENDRICKSON TRUCK SUSPENSION SYSTEMS</b>	
R		ADDITIONAL APPLICATIONS	
R	00-17	<b>INTERNATIONAL 5900I</b> All Models with Hendrickson HMX 400/460 Haulmax with 16.5" Saddle	
R	02-20	7300 All Models with Hendrickson HMX 400/460 Haulmax with 16.5" Saddle	
R	02-20	7400 All Models with Hendrickson HMX 400/460 Haulmax with 16.5" Saddle	
R	02-20	7500 All Models with Hendrickson HMX 400/460 Haulmax with 16.5" Saddle	
R	08	7600	
R	09-17	7600 All Models with Hendrickson HMX 400/460 Haulmax with 16.5" Saddle	
R	03-07	7600 All Models with Hendrickson HMX 400/460 Haulmax with 16.5" Saddle	
R	05-07	7700 All Models with Hendrickson HMX 400/460 Haulmax with 16.5" Saddle	

# Numerical listing

Shock	POP	Alternative No.	MTG Acc. Supplied
Pos.	Year	Application	
<b>83143</b>	D (cont)	<b>145128 (1)</b>	
R	19-23	HV607 All Models with Hendrickson HMX 400/460 Haulmax with 16.5" Saddle	
R	19-23	HV613 All Models with Hendrickson HMX 400/460 Haulmax with 16.5" Saddle	
R	17-22	HX515 All Models with Hendrickson HMX 400/460 Haulmax with 16.5" Saddle	
R	18-23	HX520 All Models with Hendrickson HMX 400/460 Haulmax with 16.5" Saddle	
R	17-22	HX615 All Models with Hendrickson HMX 400/460 Haulmax with 16.5" Saddle	
R	17-24	HX620 All Models with Hendrickson HMX 400/460 Haulmax with 16.5" Saddle	
R	10-13	<b>PAYSTAR - 5000 SERIES</b>	
R	10-14	<b>WORKSTAR - 7000 SERIES</b>	
R	08-23	<b>KENWORTH T370</b> All Models with Hendrickson HMX 400/460 Haulmax with 16.5" Saddle	
R	12-21	T440	
R	10-19	T470	
R	22-24	T480 All Models with Hendrickson HMX 400/460 Haulmax with 16.5" Saddle	
R	13-24	T680 All Models with Hendrickson HMX 400/460 or 520 Haulmax with 16.5" Saddle	
R	01-24	T800 All Models with Hendrickson HMX 460 Haulmax with 16.5" Saddle	
R	11-24	T880 All Models with Hendrickson HMX 400/460 or 520 Haulmax with 16.5" Saddle	
R	01-24	W900 All Models with Hendrickson HMX 400/460 Haulmax with 16.5" Saddle	
R	19-24	W990 All Models with Hendrickson HMX 400/460 or 520 Haulmax with 16.5" Saddle	
R	18-24	<b>MACK ANTHEM</b> All Models with Hendrickson HMX 400/460 Haulmax with 16.5" Saddle	
R	01-08	CV All Models with Hendrickson HMX 400/460 Haulmax with 16.5" Saddle	
R	01-14	GRANITE	
R	15-24	GRANITE All Models with Hendrickson HMX 400/460 Haulmax with 16.5" Saddle	
R	10	LE All Models with Hendrickson HMX 400/460 Haulmax with 16.5" Saddle	
R	01-07	LE All Models with Hendrickson HMX 400/460 Haulmax with 16.5" Saddle	
R	08-16	LEU All Models with Hendrickson HMX 400/460 Haulmax with 16.5" Saddle	
R	19-24	LR All Models with Hendrickson HMX 400/460 Haulmax with 16.5" Saddle	
R	01-07	MR All MR600 Models with Hendrickson HMX 400/460 Haulmax with 16.5" Saddle	
R		<b>MC NEILUS TRUCK &amp; MAN.</b>	
R		VARIOUS	
R	01-18	<b>PETERBILT 320</b> All Models with Hendrickson HMX 400/460 Haulmax with 16.5" Saddle	
R	10-23	348 All Models with Hendrickson HMX 400/460 Haulmax with 16.5" Saddle	
R	02-08	357 All Models with Hendrickson HMX 400/460 Haulmax with 16.5" Saddle	
R	08-23	365 All Models with Hendrickson HMX 400/460 Haulmax with 16.5" Saddle	
R	08-24	367 All Models with Hendrickson HMX 400/460 Haulmax with 16.5" Saddle	
R	08-15	388 All Models with Hendrickson HMX 400/460 Haulmax with 16.5" Saddle	
R	08-24	389 All Models with Hendrickson HMX 400/460 Haulmax with 16.5" Saddle	
R	17-22	520 All Models with Hendrickson HMX 400/460 Haulmax with 16.5" Saddle	

## Numerical listing

Shock	POP	Alternative No.	MTG Acc. Supplied
Pos.	Year	Application	
<b>83143</b>	D	(cont)	145128 (1)
R	22-24	548 All Models with Hendrickson HMX 400/460 Haulmax with 16.5" Saddle	
R	14-24	567 All Models with Hendrickson HMX 400/460 Haulmax with 16.5" Saddle	
R	19-23	<b>PIERCE MFG. INC.</b> VARIOUS	
R	01-23	<b>VOLVO VHD</b> All Models with Hendrickson HMX 400/460 Haulmax with 16.5" Saddle	
R	22-24	<b>WESTERN STAR 47X</b> All Models with Hendrickson HMX 400/460 Haulmax with 16.5" Saddle	
R	21-24	49X All Models with Hendrickson HMX 400/460 Haulmax with 16.5" Saddle	
R	01-02	4900 All Models with Hendrickson HMX 400/460 Haulmax with 16.5" Saddle	
R	01-02	4900E All Models with Hendrickson HMX 400/460 Haulmax with 16.5" Saddle	
R	02-22	4900EX All Models with Hendrickson HMX 400/460 Haulmax with 16.5" Saddle	
R	02-23	4900FA All Models with Hendrickson HMX 400/460 Haulmax with 16.5" Saddle	
R	02-23	4900SA All Models with Hendrickson HMX 400/460 Haulmax with 16.5" Saddle	
<b>83144</b>	W		
R		<b>HENDRICKSON TRUCK SUSPENSION SYSTEMS HAS - SERIES</b>	
F	00-03	<b>HOLIDAY RAMBLER CLASS A MOTORHOMES</b>	
R		<b>INTERNATIONAL WORKSTAR - 7000 SERIES</b>	
F	00-07	<b>MONACO COACH CLASS A MOTORHOMES</b>	
<b>83147</b>	C		
R		<b>HENDRICKSON TRUCK SUSPENSION SYSTEMS</b> VARIOUS	
R	18-24	<b>MACK ANTHEM</b> All Models with Hendrickson 38,000lb Rear Air Suspension	
R	04-07	CHU	
R	08-19	CHU All CHU-613 Models with Hendrickson 38,000 lb Rear Air Suspension	
R	05-08	CXN All CXN-613 Models with Hendrickson 38,000 lb Rear Air Suspension	
R	15-19	GRANITE All GU713 or GU813 Models with Hendrickson 38,000 lb Rear Air Suspension	
R	08-19	GU7 All GU713 Models with Hendrickson 38,000 lb Rear Air Suspension	
R	08-19	GU8 All GU813 Models with Hendrickson 38,000 lb Rear Air Suspension	
R	10-17	TD700 All TD-713 Models with Hendrickson 38,000 lb Rear Air Suspension	
R	08-17	TITAN All Models with Hendrickson 38,000 lb Rear Air Suspension	
R		<b>MC NEILUS TRUCK &amp; MAN.</b> VARIOUS	
R		<b>THOMAS</b> VARIOUS	
<b>83148</b>	D		
R	20	<b>FORD F-650</b>	
R	21-24	F-650 All Models with Hendrickson Rear Air Suspension	
R	15-19	F-650 All Models with Hendrickson Rear Air Suspension	
R	20	F-750	
R	21-24	F-750 All Models with Hendrickson Rear Air Suspension	
R	15-19	F-750 All Models with Hendrickson Rear Air Suspension	
R		<b>HENDRICKSON TRUCK SUSPENSION SYSTEMS</b> ADDITIONAL APPLICATIONS	
R		COMFORT AIR - SERIES	
R		<b>HINO</b> ADDITIONAL APPLICATIONS	
R		<b>MC NEILUS TRUCK &amp; MAN.</b> VARIOUS	

## 83000 Series

Shock	POP	Alternative No.	MTG Acc. Supplied
Pos.	Year	Application	
<b>83149</b>	W		
R		<b>HENDRICKSON TRUCK SUSPENSION SYSTEMS HAS - SERIES</b>	
<b>83150</b>	W		
R		<b>SAF HOLLAND TRAILER AIR SUSPENSION</b>	
<b>83154</b>	D	145089-000 (1)	
R		<b>FREIGHTLINER MT55</b>	
R	00-02	XCS CHASSIS	
<b>83158</b>	W		
R		<b>MOTOR COACH INDUSTRIES</b> ADDITIONAL APPLICATIONS	
<b>83160</b>	W		
F	06	<b>COACHMEN CROSS COUNTRY</b>	
F	03-05	CROSS COUNTRY ELITE	
F	03-05	CROSS COUNTRY SE	
F	02-06	<b>FLEETWOOD BOUNDER</b> All MotorHomes with Freightliner XC Chassis and AS120 Front Suspension	
F	02-06	DISCOVERY All MotorHomes with Freightliner XC Chassis and AS120 Front Suspension	
F	02-06	EXCURSION All MotorHomes with Freightliner XC Chassis and AS120 Front Suspension	
F	02-06	EXPEDITION All MotorHomes with Freightliner XC Chassis and AS120 Front Suspension	
F	04-06	PROVIDENCE All MotorHomes with Freightliner XC Chassis and AS120 Front Suspension	
F	02-04	<b>FOREST RIVER REFLECTION</b>	
F	02-06	TSUNAMI	
F	93-07	<b>FREIGHTLINER VC CHASSIS</b>	
F		XB CHASSIS	
F		XC CHASSIS	
F	93-12	XC CHASSIS	
F	01-02	XCS CHASSIS	
F	03-06	<b>GULF STREAM ATRIUM</b>	
F	02-06	FRIENDSHIP	
F	02-06	SCENIC CRUISER	
F	95-99	<b>HOLIDAY RAMBLER CLASS A MOTORHOMES</b>	
F	02-06	<b>ITASCA CLASS A MOTORHOMES</b>	
F	04-06	<b>KING OF THE ROAD CLASS A MOTORHOMES</b>	
F	04-06	<b>MANDALAY COACH CLASS A MOTORHOMES</b>	
F	95-99	<b>MONACO COACH</b> VARIOUS	
F	02-06	<b>NEWMAR CLASS A MOTORHOMES</b>	
F	02-06	<b>THOR MOTOR COACH CLASS A MOTORHOMES</b>	
<b>83162</b>	W	140780(1)/145116 & 406422 & 415010-802(1)	
F	94-96	<b>ISUZU FVR</b> All FVR Short & Middle Chassis	
F	88-92	FVR All FVR Short & Middle Chassis	
F	05-11	<b>MITSUBISHI FUSO FM330</b> All Models with O.E.M. Number	
F	89-91	<b>UD 550T</b> All Models with O.E.M. Number	
F	92-94	600T All Models with O.E.M. Number	
F	89-94	2800 All Models with O.E.M. Number	
F	95-00	3000 All Models with O.E.M. Number	
F	89-91	3000 All Models with O.E.M. Number	
F	92-94	3000HD All Models with O.E.M. Number	
F	92-94	3000SD All Models with O.E.M. Number	
F	99-13	3300 All Models with O.E.M. Number	
F	89-94	3300 All Models with O.E.M. Number	
<b>83163</b>	B		
F	06-09	<b>IC CORPORATION CE SCHOOL BUS</b>	
F	10-23	CE SCHOOL BUS All CE Model School Buses (71 Capacity) with 9,000 to 10,000 lb Front Suspension	

## Numerical listing

Shock	POP	Alternative No.	MTG Acc. Supplied
Pos.	Year	Application	
<b>83163</b>	B	(cont)	
F	08-09	<b>INTERNATIONAL 4400</b> All Models with 9,000 to 10,000 lb Front Suspension	
F		CXT SERIES	
F	20	MV All Models with 9,000 to 10,000 lb Front Suspension	
F	19-22	<b>PIERCE MFG. INC.</b> VARIOUS	
<b>83164</b>	W		
F		<b>FREIGHTLINER MP 14</b>	
F		MP 19	
<b>83166</b>	W		
R		<b>HENDRICKSON TRUCK SUSPENSION SYSTEMS</b> ADDITIONAL APPLICATIONS	
R	08-23	<b>HINO 338</b> All Models with Hendrickson Comfort Air (Single Axle - 21K & 23K)	
R	08-23	358 All Models with Hendrickson Comfort Air (Single Axle - 21K & 23K)	
R	22-24	L7	
R	22-23	L8	
R	22-23	XL7	
R	21	XL7 All Models with Hendrickson Comfort Air (Single Axle - 21K & 23K)	
R	22-23	XL8	
R	21	XL8 All Models with Hendrickson Comfort Air (Single Axle - 21K & 23K)	
R	21	XL8 All Models with Hendrickson Comfort Air (Tandem Axle - 46K)	
R	21-22	<b>LION LION8</b> All Models with Hendrickson Comfort Air Suspension (21K Capacity)	
R		<b>OSHKOSH MOTOR TRUCK CO.</b> VARIOUS	
<b>83168</b>	W		
R	21-24	<b>FORD F-650</b> All Models with Hendrickson Rear Air Suspension	
R	15-19	F-650 All Models with Hendrickson Rear Air Suspension	
R	21-24	F-750 All Models with Hendrickson Rear Air Suspension	
R	15-19	F-750 All Models with Hendrickson Rear Air Suspension	
R		<b>MC NEILUS TRUCK &amp; MAN.</b> VARIOUS	
<b>83169</b>	W		
F	08-15	<b>IC CORPORATION BE SCHOOL BUS</b> All School Buses with 7,000 lb Front Axles	
F	13-18	CE SCHOOL BUS All CE Model School Buses with 6,000 to 8,000 lb Front Axles	
F	13-18	<b>INTERNATIONAL CE SERIES SCHOOL BUS</b>	
F	13-18	DURASTAR - 4300, 4400 SERIES	
F	23-24	MV607 All Models with 6,000 to 8,000 lb Front Suspension	
<b>83175</b>	W		
F	14	<b>FORD F-650</b>	
F	15	F-650 All Models with 10,000 lb Front Suspension	
F	00-13	F-650 All Models with 10,000 lb Front Suspension	
F	14	F-750	
F	15	F-750 All Models with 10,000 lb Front Suspension	
F	00-13	F-750 All Models with 10,000 lb Front Suspension	
F	00-15	<b>GLAVAL BUS CO. CONCORDE II - SERIES</b>	
F	00-15	<b>STARCRAFT BUS CO. ALLSTAR XL &amp; XLT - SERIES</b>	
<b>83203</b>	B		
F		<b>CHANCE COACH TRANSIT BUS</b> VARIOUS	
R		<b>DURA SUSPENSION</b> VARIOUS	
R		<b>FRUEHAUF</b> VARIOUS	
F		<b>HIGHWAY PRODUCT</b> VARIOUS	
R		<b>HUTCHENS SUSPENSION</b> VARIOUS	
F		<b>ORION BUS</b> VARIOUS	
R		<b>PAGE SUSPENSION</b> VARIOUS	
R		<b>REYCO SUSPENSION TRAILER</b>	
R		<b>RIDEWELL CORP. BUS AND R.V. AIR-RIDES</b>	
R		TRAILER AIR-RIDES	

Numerical listing

Shock	POP	Alternative No.	MTG Acc. Supplied
Pos.	Year	Application	
<b>83203</b>	B	(cont)	
R		TRUCK AIR-RIDES	
R		<b>SAF HOLLAND TRUCK &amp; TRACTOR AIR SUSPENSION (TAG AXLE)</b>	
R		<b>TUTHILL TECHNOLOGIIES TRAILER</b>	
R		<b>WABASH NATIONAL VARIOUS</b>	
R		<b>WATSON &amp; CHALIN MFG. INC.</b>	
R		LWSL-1100-SR SELF STEER AXLE SUSPENSION	
R		TRAILER AIR SUSPENSION	
R		VARIOUS	
R		WCTA-1200 SERIES TRAILER AIR SUSPENSION	
R		WCTA SERIES DUMP TRAILER AIR SUSPENSION	
R		WCTA SERIES TRAILER AIR SUSPENSION	
R		WCWB SERIES TRAILER AIR SUSPENSION	
<b>83204</b>	W		
F		<b>DUPLEX VARIOUS</b>	
R		<b>DURA SUSPENSION VARIOUS</b>	
R		<b>PAGE SUSPENSION VARIOUS</b>	
R		<b>SAF HOLLAND TRUCK, BUS &amp; MOTORHOME AIR SUSPENSIONS</b>	
R		<b>TRUCK &amp; TRACTOR AIR SUSPENSION (TAG AXLE)</b>	
R		<b>TRAILMOBILE CANADA CORP. VARIOUS</b>	
R		<b>TUTHILL TECHNOLOGIIES TRAILER</b>	
R		<b>WATSON &amp; CHALIN MFG. INC. HEAVY DUTY TRAILER AIR SUSPENSION</b>	
R		<b>LIGHT WEIGHT TRAILER AIR SUSPENSION</b>	
R		LWSL-1100-SR SELF STEER AXLE SUSPENSION	
R		VARIOUS	
R		WCAL-2200 SERIES PUSHER OR TAG AXLE ASSEMBLY	
R		WCTA SERIES DUMP TRAILER AIR SUSPENSION	
R		WCTA SERIES TRAILER AIR SUSPENSION	
R		WCWB SERIES TRAILER AIR SUSPENSION	
<b>83207</b>	C		
R		<b>ADVANCE MIXER VARIOUS</b>	
F		<b>BROCKWAY SCHOOL BUS VARIOUS</b>	
F		<b>CHANCE COACH TRANSIT BUS VARIOUS</b>	
F	73-75	<b>CHEVROLET 6, 60, 6000 &amp; 6500 SERIES</b>	
R		<b>DURA SUSPENSION VARIOUS</b>	
R		<b>GILLIG VARIOUS</b>	
F	73-75	<b>GMC 6000 SERIES</b>	
F	73-75	<b>6500 SERIES</b>	
R		<b>GREAT DANE TRAILER VARIOUS</b>	
R		<b>HARDEE MFG. VARIOUS</b>	
R		<b>HENDRICKSON TRUCK SUSPENSION SYSTEMS HN - SERIES</b>	
R		<b>HIGHWAY PRODUCT VARIOUS</b>	
F		<b>INTERNATIONAL SERIES 9300, 9300I, 9400 &amp; 9400I LONG HOOD CONV.</b>	
F		SERIES 9600 & 9700 PREMIUM CABOVER TRACTOR	
R		SERIES 9600 & 9700 PREMIUM CABOVER TRACTOR	
F		SERIES 9800 - PREMIUM CABOVER TRACTOR	
F		SERIES 9900, 9900I, 9900IX LONG HOOD CONV. TRUCK	
F		<b>MACK ADDITIONAL APPLICATIONS</b>	
F	75-79	<b>ADDITIONAL APPLICATIONS F SERIES</b>	
F		R All Models with O.E.M. Number	
F	07	RD All Models with O.E.M. Number	
F	81-04	RD All Models with O.E.M. Number	
R		<b>MC NEILUS TRUCK &amp; MAN. VARIOUS</b>	
F		<b>NATIONAL COACH CORP. VARIOUS</b>	
R		<b>REYCO SUSPENSION TRAILER</b>	
R		<b>RIDWELL CORP. TRAILER AIR-RIDES</b>	
R		TRUCK AIR-RIDES	

83000 Series

Shock	POP	Alternative No.	MTG Acc. Supplied
Pos.	Year	Application	
<b>83207</b>	C	(cont)	
R		<b>SAF HOLLAND TRAILER AIR SUSPENSION</b>	
R		<b>TRUCK &amp; TRACTOR AIR SUSPENSION (TAG AXLE)</b>	
R		<b>TRAILMOBILE CANADA CORP. VARIOUS</b>	
R		<b>TUTHILL TECHNOLOGIIES TRAILER</b>	
R		<b>TWIN COACH VARIOUS</b>	
R		<b>WABASH NATIONAL VARIOUS</b>	
<b>83209</b>	D		
R		<b>ADVANCE MIXER VARIOUS</b>	
R	66-72	<b>CHEVROLET 7, 70 &amp; 7000 SERIES</b>	
F	09	<b>COACHMEN AURORA</b>	
F	07	<b>AURORA</b>	
F	99-07	<b>MIRADA</b>	
F	04-12	<b>PURSUIT</b>	
F	00-14	<b>DAMON CHALLENGER All MotorHomes with Ford F53 Chassis with 16,000 lb GVW to 22,000 lb GVW</b>	
F	12-13	<b>DAYBREAK</b>	
F	99	<b>DAYBREAK</b>	
F	00-11	<b>DAYBREAK All MotorHomes with Ford F53 Chassis with 16,000 lb GVW to 22,000 lb GVW</b>	
F	99	<b>INTRUDER</b>	
F	00-07	<b>INTRUDER All MotorHomes with Ford F53 Chassis with 16,000 lb GVW to 22,000 lb GVW</b>	
F	12-14	<b>OUTLAW</b>	
F	07-11	<b>OUTLAW All MotorHomes with Ford F53 Chassis with 16,000 lb GVW to 22,000 lb GVW</b>	
F	19-24	<b>ENTEGRA COACH EMBLEM All MotorHomes with Ford F53 Chassis with 16,000 lb GVW to 22,000 lb GVW</b>	
F	19-24	<b>VISION All MotorHomes with Ford F53 Chassis with 16,000 lb GVW to 22,000 lb GVW</b>	
F	19-20	<b>FLEETWOOD AXON</b>	
F	18	<b>AXON All MotorHomes with Ford F53 Chassis with 16,000 lb GVW to 22,000 lb GVW</b>	
F	00-24	<b>BOUNDER All MotorHomes with Ford F53 Chassis with 16,000 lb GVW to 22,000 lb GVW</b>	
F	15-24	<b>FLAIR All MotorHomes with Ford F53 Chassis with 16,000 lb GVW to 22,000 lb GVW</b>	
F	00-07	<b>FLAIR All MotorHomes with Ford F53 Chassis with 16,000 lb GVW to 22,000 lb GVW</b>	
F	23-24	<b>FLEX All MotorHomes with Ford F53 Chassis with 16,000 lb GVW to 22,000 lb GVW</b>	
F	20-24	<b>FORTIS All MotorHomes with Ford F53 Chassis with 16,000 lb GVW to 22,000 lb GVW</b>	
F	00-23	<b>SOUTHWIND All MotorHomes with Ford F53 Chassis with 16,000 lb GVW to 22,000 lb GVW</b>	
F	11-18	<b>STORM All MotorHomes with Ford F53 Chassis with 16,000 lb GVW to 22,000 lb GVW</b>	
F	01-07	<b>STORM All MotorHomes with Ford F53 Chassis with 16,000 lb GVW to 22,000 lb GVW</b>	
R	81-91	<b>FORD CL9000 All Models with Single Rear Axle Suspension</b>	
R	78-80	<b>CL &amp; CLT SERIES - HIGHWAY TRACTOR TILT CAB</b>	
R	81-91	<b>CLT9000 All Models with Single Rear Axle Suspension</b>	
F	06-23	<b>F-53</b>	
F	99-04	<b>F-53</b>	
F	88-97	<b>F-53</b>	
F	25	<b>F-53 MOTORHOME CHASSIS</b>	
F	05	<b>F-53 MOTORHOME CHASSIS</b>	
F	98	<b>F-53 MOTORHOME CHASSIS</b>	
F	06-24	<b>F-53 MOTORHOME CHASSIS All F53 Chassis with 16,000 lb GVW to 22,000 lb GVW</b>	
F	99-04	<b>F-53 MOTORHOME CHASSIS All F53 Chassis with 16,000 lb GVW to 22,000 lb GVW</b>	
F	88-97	<b>F-53 MOTORHOME CHASSIS All F53 Chassis with 16,000 lb GVW to 22,000 lb GVW</b>	
R	73-77	<b>W AND WT SERIES - HI TILT CAB HIGHWAY TRACTOR</b>	

Numerical listing

Shock	POP	Alternative No.	MTG Acc. Supplied
Pos.	Year	Application	
<b>83209</b>	D	(cont)	
F	99-09	<b>GEORGIE BOY MANUFACTURING CLASS A MOTORHOMES</b>	
R	66-72	<b>GMC 7500 SERIES</b>	
F	11-15	<b>HOLIDAY RAMBLER ADMIRAL</b>	
F	02-06	<b>ADMIRAL</b>	
F	15	<b>ENDEAVOR</b>	
F	10	<b>VACATIONER</b>	
F	08	<b>VACATIONER</b>	
R		<b>INTERNATIONAL F &amp; S SERIES</b>	
R		SERIES 9300, 9300I, 9400 & 9400I LONG HOOD CONV.	
R		SERIES 9600 & 9700 PREMIUM CABOVER TRACTOR	
R		SERIES 9900, 9900I, 9900IX LONG HOOD CONV. TRUCK	
F	99-15	<b>ITASCA CLASS A MOTORHOMES</b>	
F	81-03	<b>MACK DM All DM Models</b>	
F	01-06	<b>LE All LE 613 Models with O.E.M. Number</b>	
F	09	<b>LEU All LEU 613 Models with 18,000 lb Front Axle</b>	
F	81-07	<b>MR All MR600 Models with 20,000 lb Front Axle</b>	
F	08-19	<b>MRU All MRU613 Models with O.E.M. Number</b>	
F	92-05	<b>RB All RB 600 Models (Drive Axle)</b>	
R		<b>MC NEILUS TRUCK &amp; MAN. VARIOUS</b>	
F	07-08	<b>MONACO COACH LA PALMA</b>	
F	01	<b>LA PALMA</b>	
F	90-99	<b>LA PALMA</b>	
F	12-13	<b>LA PALMA All MotorHomes with Ford F53 Chassis with 16,000 lb GVW to 22,000 lb GVW</b>	
F	09	<b>LA PALMA All MotorHomes with Ford F53 Chassis with 16,000 lb GVW to 22,000 lb GVW</b>	
F	02-06	<b>LA PALMA All MotorHomes with Ford F53 Chassis with 16,000 lb GVW to 22,000 lb GVW</b>	
F	00	<b>LA PALMA All MotorHomes with Ford F53 Chassis with 16,000 lb GVW to 22,000 lb GVW</b>	
F	03-05	<b>MONARCH</b>	
F	90-99	<b>MONARCH</b>	
F	06-14	<b>MONARCH All MotorHomes with Ford F53 Chassis with 16,000 lb GVW to 22,000 lb GVW</b>	
F	01-02	<b>MONARCH All MotorHomes with Ford F53 Chassis with 16,000 lb GVW to 22,000 lb GVW</b>	
F	99-08	<b>NATIONAL RV CLASS A MOTORHOMES</b>	
F	13-20	<b>NEWMAR CLASS A MOTORHOMES</b>	
R		<b>REYCO SUSPENSION DRIVE AXLE</b>	
R		<b>SAF HOLLAND TRAILER AIR SUSPENSION</b>	
R		<b>TRUCK, BUS &amp; MOTORHOME AIR SUSPENSIONS</b>	
R		<b>TRUCK &amp; TRACTOR AIR SUSPENSION (TAG AXLE)</b>	
F	05-08	<b>THOR MOTOR COACH CHALLENGER</b>	
F	04-10	<b>HURRICANE</b>	
F	07-10	<b>OUTLAW</b>	
F	06-10	<b>WINDSPORT</b>	
R		<b>TRAILMOBILE CANADA CORP. VARIOUS</b>	
R		<b>TUTHILL TECHNOLOGIIES DRIVE AXLE</b>	
R	98	<b>WESTERN STAR 3800</b>	
R	99-01	<b>3800 All Models with Neway Rear Suspension</b>	
R	89-97	<b>3800 All Models with Neway Rear Suspension</b>	
R	89-02	<b>4800 All Models with Neway Rear Suspension</b>	
R	89-02	<b>4900 All Models with Neway Rear Suspension</b>	
R	97-02	<b>5800 All Models with Neway Rear Suspension</b>	
R	89-01	<b>5900 All Models with Neway Rear Suspension</b>	
R	89-01	<b>6900 All Models with Neway Rear Suspension</b>	
F	23	<b>WINNEBAGO SUNSTAR NPF</b>	
F	23	<b>VISTA NPF</b>	
<b>83214</b>	W	401754 (4)	
F		<b>DIAMOND REO VARIOUS</b>	
R		<b>EAST MANUFACTURING CORP. VARIOUS</b>	



## Numerical listing

Shock	POP	Alternative No.	MTG Acc. Supplied
Pos.	Year	Application	
<b>83214</b>	W	(cont)	<b>401754 (4)</b>
R		<b>GRANNING SUSPENSION VARIOUS</b>	
F		<b>OSTERLUND TRUCK VARIOUS</b>	
F		<b>OTTAWA VARIOUS</b>	
F		<b>SPARTAN MOTORS VARIOUS</b>	
R		<b>TUTHILL TECHNOLOGIES TRAILER</b>	
<b>83215</b>	W		<b>401754 (4)</b>
F		<b>BROCKWAY SCHOOL BUS VARIOUS</b>	
R	86-94	<b>FORD F-600</b> All Models with O.E.M. Number	
R	80-90	F-600 All Models with 17000 & 18000 lb Rear Axle	
R	86-98	F-700 All Models with O.E.M. Number	
R	80-90	F-700 All Models with 17000 & 18000 lb Rear Axle	
R	86-97	F-800 All Models with O.E.M. Number	
R	80-90	F-800 All Models with 17000 & 18000 lb Rear Axle	
R	90-98	FT900 All Models with shock located forward of rear axle	
R	93-97	<b>HINO FD2218LD</b>	
R	98	<b>FF SERIES</b>	
R		<b>INTERNATIONAL S SERIES SCHOOL BUS</b>	
F		<b>MACK ADDITIONAL APPLICATIONS</b>	
R		ADDITIONAL APPLICATIONS	
R	75-79	ADDITIONAL APPLICATIONS	
R	04-07	CHN All CHN-613 Models with Camelback Rear Suspension (SS34 & 38)	
R	08-19	CHU All CHU-613 Models with Camelback Rear Suspension (SS34 & 38)	
R	81-03	DM All DM Models	
R		F SERIES	
F	83-94	MH All MH Models - 4" Wide Springs	
R	83-94	MH All MH Models with Camelback Rear Suspension (SS34 & 38)	
F	83-94	MH All MH Models with O.E.M. Number	
R	81-07	MR All MR600 Models with Camelback Rear Suspension (SS34 & 38)	
R	89-91	R All RB 600 Models (Drive Axle)	
F	85-93	RW All RW Models - 4" Wide Springs	
R	85-93	RW All RW Models with Camelback Rear Suspension (SS34 & 38)	
F	85-93	RW All RW Models with O.E.M. Number	
F		<b>PAI CORP. VARIOUS</b>	
R		<b>REYCO SUSPENSION DRIVE AXLE</b>	
R		<b>TUTHILL TECHNOLOGIES DRIVE AXLE</b>	
R	77-96	<b>VOLVO B - SERIES - BUS COWL CHASSIS</b>	
R		FE SERIES	
F		N SERIES	
<b>83216</b>	W		<b>140149 (1)</b>
F		<b>AUTOCAR LLC. ADDITIONAL APPLICATIONS</b>	
F		<b>BROCKWAY SCHOOL BUS VARIOUS</b>	
F	66-80	<b>CHEVROLET 7, 70 &amp; 7000 SERIES</b>	
F	66-81	8, 80 & 8000 SERIES	
F	70-72	9000 SERIES	
F	64-67	<b>FORD C &amp; CT SERIES - TILT CAB</b>	
F	64-69	F SERIES - CONVENTIONAL CAB	
F	91-97	L8000F All Models with 4000, 4500, 5400, 6000, 7200 lb Multileaf Springs and with 9000, 10000, 12000 or 16000 lb Axles	
F	91-97	L9000 All Models with 4000, 4500, 5400, 6000, 7200 lb Multileaf Springs and with 9000, 10000, 12000 or 16000 lb Axles	
F	91-97	LA8000F All Models with 4000, 4500, 5400, 6000, or 7200 lb. Multileaf Spring	
F	91-97	LA9000 All Models with 4000, 4500, 5400, 6000, or 7200 lb. Multileaf Spring	

## 83000 Series

Shock	POP	Alternative No.	MTG Acc. Supplied
Pos.	Year	Application	
<b>83216</b>	W	(cont)	<b>140149 (1)</b>
F	94-96	LL9000 All Models with 4000, 4500, 5400, 6000 or 7200 lb Multileaf Springs and with 9000, 10000, 12000 or 16000 lb Axles	
F	91-92	LL9000 All Models with 4000, 4500, 5400, 6000 or 7200 lb Multileaf Springs and with 9000, 10000, 12000 or 16000 lb Axles	
F	92-97	LLA9000 All Models with 4000, 4500, 5400, 6000 or 7200 lb Multileaf Springs and with 9000, 10000, 12000 or 16000 lb Axles	
F	91-97	LN7000 All Models with 4000, 4500, 5400, 6000 or 7200 lb Multileaf Springs and with 9000, 10000, 12000 or 16000 lb Axles	
F	91-97	LN8000 All Models with 4000, 4500, 5400, 6000 or 7200 lb Multileaf Springs and with 9000, 10000, 12000 or 16000 lb Axles	
F	91-97	LN9000 All Models with 4000, 4500, 5400, 6000 or 7200 lb Multileaf Springs and with 9000, 10000, 12000 or 16000 lb Axles	
F	91-97	LNT8000F All Models with 4000, 4500, 5400, 6000 or 7200 lb Multileaf Springs and with 9000, 10000, 12000 or 16000 lb Axles	
F	91-97	LNT9000 All Models with 4000, 4500, 5400, 6000 or 7200 lb Multileaf Springs and with 9000, 10000, 12000 or 16000 lb Axles	
F	91-97	LT9000 All Models with 4000, 4500, 5400, 6000, 7200 lb Multileaf Springs and with 9000, 10000, 12000 or 16000 lb Axles	
F	91-97	LTA9000 All Models with 4000, 4500, 5400, 6000 or 7200 lb Multileaf Springs and with 9000, 10000, 12000 or 16000 lb Axles	
F	92-97	LTLA9000 All Models with 4000, 4500, 5400, 6000 or 7200 lb Multileaf Springs and with 9000, 10000, 12000 or 16000 lb Axles	
R		<b>GILLIG VARIOUS</b>	
F	66-75	<b>GMC 6500 SERIES</b>	
F	66-80	7500 SERIES	
F	73-81	8500 SERIES	
F	67	8500 SERIES	
F	67-72	9500 SERIES	
R		<b>INTERNATIONAL A, B, AC AND BC CONVENTIONAL</b>	
F		<b>FLEETSTAR - CONVENTIONAL</b>	
F		<b>LOADSTAR - CONVENTIONAL</b>	
R		<b>LOADSTAR - CONVENTIONAL</b>	
R		<b>S SERIES SCHOOL BUS</b>	
R		<b>S SERIES SCHOOL BUS</b>	
R		<b>NEOPLAN VARIOUS</b>	
F		<b>ONEIDA PRODUCTS VARIOUS</b>	
F		<b>VOLVO WCA &amp; WIA SERIES</b>	
F		<b>WESTERN STAR 5900 &amp; 6900 SERIES - HERITAGE CLASS</b>	
<b>83219</b>	W		<b>140149 (1)</b>
F		<b>GILLIG VARIOUS</b>	
R		<b>GMC ADDITIONAL APPLICATIONS</b>	
F	08-16	<b>PETERBILT 384</b> All Models with 12,000 lb to 14,600 lb Taperleaf Spring Suspension and Set Forward Front Axle. (Std Duty)	
F	13-15	388 All Models with 12,000 lb to 14,600 lb Taperleaf Spring Suspension and Set Forward Front Axle. (Std Duty)	
R		<b>VOLVO ADDITIONAL APPLICATIONS</b>	
<b>83221</b>	W		
R	76-89	<b>CHEVROLET 6, 60, 6000 &amp; 6500 SERIES</b>	
F	68-80	6, 60, 6000 & 6500 SERIES	
R	67-68	6, 60, 6000 & 6500 SERIES	
R	66-72	7, 70 & 7000 SERIES	
R	83-99	C4500 KODIAK	
R	92-99	C5500 KODIAK	
R	83-89	C5500 KODIAK	
R	83-96	C6500 KODIAK	
R	97-99	C6500 KODIAK All Conventional Cab with 9100 to 17500 lb Rear Axle	
R	83-96	C7500 KODIAK	
R	97-99	C7500 KODIAK All Conventional Cab with 9100 to 17500 lb Rear Axle	
R	60-62	<b>GMC 3500 &amp; 4000 SERIES</b>	
R	76-89	5000 SERIES	

## Numerical listing

Shock	POP	Alternative No.	MTG Acc. Supplied
Pos.	Year	Application	
<b>83221</b>	W	(cont)	
F	75-80	5000 SERIES	
R	60-62	5000 SERIES	
R	66-80	6500 SERIES	
F	75-76	6500 SERIES	
F	66-72	6500 SERIES	
R	79-81	7000 SERIES	
R	66-72	7500 SERIES	
R	83-99	C - SERIES (C4500, C5500) TOPKICK	
R	83-99	C - SERIES (C6500, C7500, C8500) TOPKICK	
F		<b>MACK ADDITIONAL APPLICATIONS</b>	
F		F SERIES	
R		<b>OSHKOSH MOTOR TRUCK CO. VARIOUS</b>	
F		<b>PAI CORP. VARIOUS</b>	
F		<b>WORKHORSE VARIOUS</b>	
<b>83225</b>	W		<b>401754 (4)</b>
R	64-67	<b>FORD C &amp; CT SERIES - TILT CAB</b>	
R	70-90	F-600 All Models with 13000 & 15000 lb Rear Axle	
R	70-90	F-700 All Models with 13000 & 15000 lb Rear Axle	
R	80-89	F-800 All Models with 13000 & 15000 lb Rear Axle	
R	81-90	F SERIES - CONVENTIONAL CAB	
R	64-79	F SERIES - CONVENTIONAL CAB	
R	80-86	LN700 All Models with 11000, 13000, 15000, 17000 lb Axles	
R	86-89	LN & LNT - CONVENTIONAL CAB	
R	73-76	MOTORHOME CHASSIS	
R	64-69	N AND NT 89" BBC CONVENTIONAL CAB	
R		<b>INTERNATIONAL A, B, AC AND BC CONVENTIONAL</b>	
F		<b>FIRETRUCK</b>	
F		<b>FLEETSTAR - CONVENTIONAL</b>	
F		<b>SERIES 3000 - SCHOOL BUS CHASSIS</b>	
F		S SERIES SCHOOL BUS	
R		S SERIES SCHOOL BUS	
R		<b>TRAILMOBILE CANADA CORP. VARIOUS</b>	
<b>83242</b>	W		
F	81-03	<b>MACK DM</b> All Models with O.E.M. Number	
<b>83243</b>	W		
R	23	<b>INTERNATIONAL CV515</b> All Models with 4 x 4 Rear	
<b>83244</b>	W		<b>145178 (1)</b>
R	20-21	<b>IC CORPORATION CE SCHOOL BUS</b> All CE Model School Buses with 17,000 lb - 22,000 lb rear suspension	
R	19-21	<b>INTERNATIONAL VARIOUS</b>	
<b>83301</b>	W		<b>141083 (1)</b>
R		<b>INTERNATIONAL F &amp; S SERIES</b>	
R		<b>METRO &amp; MULTI-SHOP SERIES</b>	
R		<b>SERIES 1000 FORWARD CONTROL CHASSIS</b>	
R		<b>SERIES 3000 - SCHOOL BUS CHASSIS</b>	
<b>83303</b>	W		<b>140702 (1)</b>
F	73-89	<b>CHEVROLET 6, 60, 6000 &amp; 6500 SERIES</b>	
F	73-89	7, 70 & 7000 SERIES	
F	72-80	<b>GMC 4500 SERIES</b>	
F	79-80	6000 SERIES	
F	75-89	6500 SERIES	
F	79-89	7000 SERIES	
F	73-80	7500 SERIES	
<b>83308</b>	W		<b>140149 (1)</b>
F	80-86	<b>FORD C700</b> All Models with 3100 lb Spring and 7000 lb Axle	
F	80-89	C800 All Models with 3100 lb Spring and 7000 lb Axle	
F	80-86	C7000 All Models with 3100 lb Spring and 7000 lb Axle	
F	80-90	C8000 All Models with 3100 lb Spring and 7000 lb Axle	
F	64-69	C & CT SERIES - TILT CAB	
F	81-82	CT800D All Models with 3100 lb Spring and 7000 lb Axle	
F	81-90	CT8000 All Models with 3100 lb Spring and 7000 lb Axle	
F	70-79	F SERIES - CONVENTIONAL CAB	



# Numerical listing

Shock	POP	Alternative No.	MTG Acc. Supplied
Pos.	Year	Application	

83308	W	(cont)	140149 (1)
F	91-97	L8000F All Models with 4500, 5400, 6000, 7200, 10000 lb Multileaf Springs and with 10000, 12000, 13200, 16000 lb Axles	
F	91-97	L9000 All Models with 4500, 5400, 6000, 7200, 10000 lb Multileaf Springs and with 10000, 12000, 13200, 16000 lb Axles	
F	91-97	LA8000F All Models with with 4500 lb to 10000 lb Multileaf Spring	
F	90-97	LA9000 All Models with with 4500 lb to 10000 lb Multileaf Spring	
F	94-96	LL9000 All Models with 4500, 5000, 6000 lb Springs and with 10000, 11000, 12000 lb Axles	
F	90-92	LL9000 All Models with 4500, 5000, 6000 lb Springs and with 10000, 11000, 12000 lb Axles	
F	93	LL, LLA, LTA, LTL, LTLA - CONVENTIONAL CAB	
F	92-97	LLA9000 All Models With 4500, 5400, 6000, 7200 or 10000 lb. Multileaf Spring	
F	80-86	LN700 All Models with 3000, 3300 lb Springs and 5000, 5500, 6000, 7000 lb Axles	
F	80-85	LN800 All Models with 3000, 3300 lb Springs and 5000, 5500, 6000, 7000 lb Axles	
F	91-97	LN7000 All Models with 4500, 5400, 6000, 7200, 10000 lb Springs and with 10000, 12000, 13200, 16000 lb Axles	
F	81-97	LN7000 All Models with 3000, 3300 lb Springs and 5000, 5500, 6000, 7000 lb Axles	
F	91-97	LN8000 All Models with 4500, 5400, 6000, 7200, 10000 lb Springs and with 10000, 12000, 13200, 16000 lb Axles	
F	81-97	LN8000 All Models with 3000, 3300 lb Springs and 5000, 5500, 6000, 7000 lb Axles	
F	91-97	LN9000 All Models with 4500, 5400, 6000, 7200, 10000 lb Springs and with 10000, 12000, 13200, 16000 lb Axles	
F	70-89	LN & LNT - CONVENTIONAL CAB	
F	81-84	LNT800 All Models with 3000, 3300 lb Springs and 5000, 5500, 6000, 7000 lb Axles	
F	81-89	LNT8000 All Models with 3000, 3300 lb Springs and 5000, 5500, 6000, 7000 lb Axles	
F	91-97	LNT8000F All Models with 4500, 5400, 6000, 7200, 10000 lb Springs and with 10000, 12000, 13200, 16000 lb Axles	
F	87-97	LNT8000F All Models with 3000, 3300 lb Springs and 5000, 5500, 6000, 7000 lb Axles	
F	91-97	LNT9000 All Models with 4500, 5400, 6000, 7200, 10000 lb Springs and with 10000, 12000, 13200, 16000 lb Axles	
F	90-97	LS8000F All Models with with 4500 lb to 10000 lb Multileaf Spring	
F	91-97	LT9000 All Models with 4500, 5400, 6000, 7200, 10000 lb Multileaf Springs and with 10000, 12000, 13200, 16000 lb Axles	
F	91-97	LTA9000 All Models With 4500, 5400, 6000, 7200 or 10000 lb. Multileaf Spring	
F	92-97	LTLA9000 All Models With 4500, 5400, 6000, 7200 or 10000 lb. Multileaf Spring	
F	64-69	N AND NT 89" BBC CONVENTIONAL CAB	
R		INTERNATIONAL LOADSTAR - CONVENTIONAL	
R		S SERIES SCHOOL BUS	

83309	W	(1)	140149 (1)
F	80-94	FORD B-600 All B - Series - Bus Cowl Chassis	
F	80-94	B-700 All B - Series - Bus Cowl Chassis	
F	95-96	B-800 All B - Series - Bus Cowl Chassis	
F	83-87	B-7000 All B - Series - Bus Cowl Chassis	
F	80-94	F-600 All Exc. 9000 lb Axle with H.D. Suspension & 12000 lb Axle	

# 83000 Series

Shock	POP	Alternative No.	MTG Acc. Supplied
Pos.	Year	Application	

83309	W	(cont)	140149 (1)
F	90	F-600 All Models with Multileaf Spring	
F	80-94	F-700 All Exc. 9000 lb Axle with H.D. Suspension & 12000 lb Axle	
F	90	F-700 All Models with Multileaf Spring	
F	80-94	F-800 All Exc. 9000 lb Axle with H.D. Suspension & 12000 lb Axle	
F	90	F-800 All Models with Multileaf Spring	
F	80-87	F-7000 All Exc. 9000 lb Axle with H.D. Suspension & 12000 lb Axle	
F	83-87	F-8000 All Exc. 9000 lb Axle with H.D. Suspension & 12000 lb Axle	
F	80-90	F SERIES - CONVENTIONAL CAB	
F	80-90	FT800 All Exc. 9000 lb Axle with H.D. Suspension & 12000 lb Axle	
F	90-94	FT900 All Low Profile Models with 9000 lb Axle with H.D. Suspension or 10000, 11000, or 12000 lb Axles	
F	90-94	FT900 All Models with 9000 lb Axle with H.D. Suspension or 10000, 11000, or 12000 lb Axles	
F	83-87	FT8000 All Exc. 9000 lb Axle with H.D. Suspension & 12000 lb Axle	
F	80-85	L800 All Models with 7000, 9000, 12000, 16000 lb Axles	
F	81	L900 All Models with 7000, 9000, 12000, 16000 lb Axles	
F	81-88	L8000 All Models with 7000, 9000, 12000, 16000 lb Axles	
F	81-90	L9000 All Models with 7000, 9000, 12000, 16000 lb Axles	
F	73-80	L, LT & LTS - CONVENTIONAL CAB	
F	80-85	LN800 All Models with 6000, 7000, 9000, 12000, 16000 lb Axles	
F	81	LN900 All Models with 6000, 7000, 9000, 12000, 16000 lb Axles	
F	81-88	LN8000 All Models with 6000, 7000, 9000, 12000, 16000 lb Axles	
F	81-89	LN9000 All Models with 6000, 7000, 9000, 12000, 16000 lb Axles	
F	70-79	LN & LNT - CONVENTIONAL CAB	
F	81-84	LNT800 All Models with 6000, 7000, 9000, 12000, 16000 lb Axles	
F	81	LNT900 All Models with 6000, 7000, 9000, 12000, 16000 lb Axles	
F	81-89	LNT8000 All Models with 6000, 7000, 9000, 12000, 16000 lb Axles	
F	81-89	LNT9000 All Models with 6000, 7000, 9000, 12000, 16000 lb Axles	
F	81-88	LT800 All Models with 7000, 9000, 12000, 16000 lb Axles	
F	81-88	LT8000 All Models with 7000, 9000, 12000, 16000 lb Axles	
F	81-90	LT9000 All Models with 7000, 9000, 12000, 16000 lb Axles	
F	81-90	LTS9000 All Models with 7000, 9000, 12000, 16000 lb Axles	

83312	W	(1)	140149 (1)
F	80-86	FORD C700 All Models with 4040, 5040 lb Springs and 7000, 9000, 12000 lb Axles	
F	80-86	C800 All Models with 4040, 5040 lb Springs and 7000, 9000, 12000 lb Axles	
F	80-86	C7000 All Models with 4040, 5040 lb Springs and 7000, 9000, 12000 lb Axles	
F	87-90	C & CT SERIES - TILT CAB	
F	67-79	C & CT SERIES - TILT CAB	
F	81-86	CT8000 All Models with 4040, 5040 lb Springs and 7000, 9000, 12000 lb Axles	
F	73-79	F SERIES - CONVENTIONAL CAB	
F	64-69	F SERIES - CONVENTIONAL CAB	
F	80-85	L800 All Models with 7000, 9000, 12000 lb Axles	
F	81	L900 All Models with 7000, 9000, 12000 lb Axles	
F	81-88	L8000 All Models with 7000, 9000, 12000 lb Axles	
F	91-97	L8000F All Models with Multleaf Spring	
F	91-97	L9000 All Models with Multleaf Spring	
F	81-97	L9000 All Models with 7000, 9000, 12000 lb Axles	
F	73-89	L, LT & LTS - CONVENTIONAL CAB	
F	80-86	LN700 All Models with 4400 lb Spring and 7000, 9000 lb Axles	
F	80-85	LN800 All Models with 4400 lb Spring and 7000, 9000 lb Axles	

# Numerical listing

Shock	POP	Alternative No.	MTG Acc. Supplied
Pos.	Year	Application	

83312	W	(cont)	140149 (1)
F	90-97	LN7000 All Models with Multileaf Spring	
F	81-97	LN7000 All Models with 4400 lb Spring and 7000, 9000 lb Axles	
F	90-97	LN8000 All Models with Multileaf Spring	
F	81-97	LN8000 All Models with 4400 lb Spring and 7000, 9000 lb Axles	
F	90-97	LN9000 All Models with Multileaf Spring	
F	70-89	LN & LNT - CONVENTIONAL CAB	
F	81-84	LNT800 All Models with 4400 lb Spring and 7000, 9000 lb Axles	
F	81-89	LNT8000 All Models with 4400 lb Spring and 7000, 9000 lb Axles	
F	90-97	LNT8000F All Models with Multileaf Spring	
F	90-97	LNT9000 All Models with Multileaf Spring	
F	81-84	LT800 All Models with 7000, 9000, 12000 lb Axles	
F	81-88	LT8000 All Models with 7000, 9000, 12000 lb Axles	
F	91-97	LT9000 All Models with Multleaf Spring	
F	81-97	LT9000 All Models with 7000, 9000, 12000 lb Axles	
F	81-89	LTS9000 All Models with 16000 lb Axle	
F	64-69	N AND NT 89" BBC CONVENTIONAL CAB	
F		KENWORTH C500, C500B, C500K, C540 & C550	
F		K100, K100E, K125	
F	93-05	K300 All Models with Multiple Leaf Springs on Front Axle (3/4" Mounting bolts)	
F		T300	
F		T400, T400B, T450B	
F		T600, T600A, T600B, T602	
F		T800, T800B, T800B(8X4), T800SH, T800H, T800W	
F		T2000	
F		W900, W900B, W900L, W900S	
F		OSHKOSH MOTOR TRUCK CO. VARIOUS	
F		PIERCE MFG. INC. VARIOUS	

83314	W	(1)	140149 (1)
F	83-89	FORD F-600 All Models with 9000 lb Axle with H.D. Suspension & 12000 lb Axle	
F	94-98	F-700 All Models with Taperleaf Springs and with 6000, 7000, 8500, 9000 lb Axle	
F	83-89	F-700 All Models with 9000 lb Axle with H.D. Suspension & 12000 lb Axle	
F	94-98	F-800 All Models with Taperleaf Springs and with 6000, 7000, 8500, 9000 lb Axle	
F	83-89	F-800 All Models with 9000 lb Axle with H.D. Suspension & 12000 lb Axle	
F	83-87	F-7000 All Models with 9000 lb Axle with H.D. Suspension & 12000 lb Axle	
F	83-87	F-8000 All Models with 9000 lb Axle with H.D. Suspension & 12000 lb Axle	
F	64-69	F SERIES - CONVENTIONAL CAB	
F	83-89	FT800 All Models with 9000 lb Axle with H.D. Suspension & 12000 lb Axle	
F	94-97	FT900 All Models with Taperleaf Springs and with 6000, 7000, 8500 or 9000 lb Axles	
F	83-87	FT8000 All Models with 9000 lb Axle with H.D. Suspension & 12000 lb Axle	
F	61-66	H AND HT SERIES - HI TILT CAB	
F	80-85	L800 All Models with 7000, 9000, 12000, 16000 lb Axles	
F	81	L900 All Models with 7000, 9000, 12000, 16000 lb Axles	
F	81-85	L8000 All Models with 7000, 9000, 12000, 16000 lb Axles	
F	81-85	L9000 All Models with 7000, 9000, 12000, 16000 lb Axles	
F	73-79	L, LT & LTS - CONVENTIONAL CAB	
F	76-81	LN & LNT - CONVENTIONAL CAB	
F	81-84	LT800 All Models with 7000, 9000, 12000, 16000 lb Axles	

## Numerical listing

Shock	POP	Alternative No.	MTG Acc. Supplied
Pos.	Year	Application	
<b>83314</b>	W	(cont)	<b>140149 (1)</b>
F	81-85	LT8000 All Models with 7000, 9000, 12000, 16000 lb Axles	
F	81-85	LT9000 All Models with 7000, 9000, 12000, 16000 lb Axles	
F	82-85	LTL9000 All Models with 7000, 9000, 12000 lb. Axle	
F	81-85	LTS9000 All Models with 7000, 9000, 12000, 16000 lb Axles	
F	64-69	N AND NT 89" BBC CONVENTIONAL CAB	
F	64-69	T-SERIES - CONVENTIONAL TANDEM	
<b>83317</b>	W		<b>141083 (1)</b>
R	14	FORD F-650	
R	15	F-650 All Models with 22,000 lb Multi-leaf Rear Springs	
R	04-13	F-650 All Models with 22,000 lb Multi-leaf Rear Springs	
R	14	F-750	
R	15	F-750 All Models with 22,000 lb Multi-leaf Rear Springs	
R	04-13	F-750 All Models with 22,000 lb Multi-leaf Rear Springs	
R	04-15	GLAVAL BUS CO. CONCORDE II - SERIES	
R	08-15	IC CORPORATION BE SCHOOL BUS - All School Buses with O.E.M. Number	
R	05-09	CE SCHOOL BUS	
R	10-13	CE SCHOOL BUS All CE Model School Buses with 22,000 lb Rear Spring Suspension	
R	02-13	INTERNATIONAL 4400 All Models with 22,000 lb Rear Spring Suspension	
R		BE SERIES SCHOOL BUS	
R	05-13	CE SERIES SCHOOL BUS	
R		F & S SERIES	
R		METRO & MULTI-SHOP SERIES	
R		SERIES 2000 - CONVENTIONAL TRUCK (SEVERE SERVICE)	
R		SERIES 3000 - SCHOOL BUS CHASSIS	
R		SERIES 4000 - SHORT CONVENTIONAL MEDIUM TRK & TRAC	
R		SERIES 7000 - SHORT CONV. MEDIUM TRUCK & TRACTOR	
R		SERIES 8000 - CONVENTIONAL HEAVY DUTY TRACTOR	
R		S SERIES SCHOOL BUS	
R	04-11	STARCRAFT BUS CO. ALLSTAR XL & XLT - SERIES	
<b>83318</b>	W		<b>141083 (2)</b>
F		INTERNATIONAL BINDER	
F		F & S SERIES	
F		METRO & MULTI-SHOP SERIES	
F		S SERIES SCHOOL BUS	
<b>83363</b>	W		
R		SAF HOLLAND TRAILER AIR SUSPENSION	
<b>83364</b>	W		
R		STERLING TRUCK VARIOUS	
<b>83389</b>	W		
R		GREAT DANE TRAILER VARIOUS	
R		HENDRICKSON TRAILER SUSPENSION SYSTEMS	
R		ADDITIONAL APPLICATIONS	
R		TOP MOUNT STYLE	
R		UNDERSLUNG STYLE	
R		VANTRAAK	
R		SAF HOLLAND TRAILER AIR SUSPENSION	
R		TRUCK & TRACTOR AIR SUSPENSION (TAG AXLE)	
R		STOUGHTON TRAILERS INC. VARIOUS	
R		UTILITY TRAILER	
R		MANUFACTURING COMPANY	
R		REEFERS & DRY VANS	
R		WABASH NATIONAL VARIOUS	
<b>83391</b>	W		<b>145177 (2)</b>
F	15-22	HINO 338 All Models with O.E.M. Number	
F	15-21	358 All Models with O.E.M. Number	
F	22-24	L7	

## 83000 Series, Cab Shock

Shock	POP	Alternative No.	MTG Acc. Supplied
Pos.	Year	Application	
<b>83396</b>	A		
F	18-24	FREIGHTLINER CASCADIA All 126 Models with 12000 to 13300 lb Taperleaf Front Suspension	
F	18-21	CASCADIA All 116 Models with 12000 to 13300 lb Taperleaf Front Suspension	
F	18-20	CASCADIA All 113 Models with 12000 to 13300 lb Taperleaf Front Suspension	
F	23-24	WESTERN STAR 57X All Models with 12000 to 13300 lb Taperleaf Front Suspension	
<b>83397</b>	W		
F	23	INTERNATIONAL CV515 All Models with Taperleaf Front	
<b>83398</b>	W		
R	23	INTERNATIONAL CV515 All Models with 11K, 13.5K or 15.5K VARI-RATE Rear Suspension	
<b>83400</b>	W		<b>140455 (2)</b>
F		GMC WH SERIES	
R		MOR-RYDE SUSPENSION	
F		VARIOUS	
F		VOLVO ADDITIONAL APPLICATIONS	
F		WCA & WIA SERIES	
F		WH SERIES	
R		WATSON & CHALIN MFG. INC. WCWB SERIES TRAILER AIR SUSPENSION	
F		WESTERN STAR 5900 & 6900 SERIES - HERITAGE CLASS	
<b>83401</b>	W		
F		VOLVO ADDITIONAL APPLICATIONS	
F	89-01	WESTERN STAR 5900 All All with 4 shock Front System	
F	89-01	6900 All All with 4 shock Front System	
<b>83456</b>	D		<b>142998 (2)</b>
F	03-18	IC CORPORATION RE SCHOOL BUS All RE Model School Buses with O.E.M. Number	
F		INTERNATIONAL F & S SERIES	
F		METRO & MULTI-SHOP SERIES	
F		SERIES 1000 FORWARD CONTROL CHASSIS	
F		SERIES 2000 - CONVENTIONAL TRUCK (SEVERE SERVICE)	
F		SERIES 3000 - SCHOOL BUS CHASSIS	
F		SERIES 7000 - SHORT CONV. MEDIUM TRUCK & TRACTOR	
F		SERIES 8000 - CONVENTIONAL HEAVY DUTY TRACTOR	
F		S SERIES SCHOOL BUS	
F	86-88	MITSUBISHI FUSO FM All Models with O.E.M. Number	
<b>83515</b>	W		<b>140885 (1)</b>
F	85	ISUZU ADDITIONAL APPLICATIONS	
F		ALL MODELS WITH	
<b>83613</b>	W		<b>141083 (2)</b>
F		INTERNATIONAL SERIES 4000 - SHORT CONVENTIONAL MEDIUM TRK & TRAC	
R	94-96	ISUZU FVR All Models with O.E.M. Number	
R	88-92	FVR All Models with O.E.M. Number	
<b>83635</b>	W		<b>145054 (1)</b>
R		SAF HOLLAND TRUCK, BUS & MOTORHOME AIR SUSPENSIONS	
R		TRUCK & TRACTOR AIR SUSPENSION (TAG AXLE)	
R	98	WESTERN STAR 3800	
R	99-01	3800 All Models with Neway Rear Suspension	
R	89-97	3800 All Models with Neway Rear Suspension	
R	89-02	4800 All Models with Neway Rear Suspension	
R	89-02	4900 All Models with Neway Rear Suspension	
R	97-02	5800 All Models with Neway Rear Suspension	
R	89-01	5900 All Models with Neway Rear Suspension	

## Numerical listing

Shock	POP	Alternative No.	MTG Acc. Supplied
Pos.	Year	Application	
<b>83635</b>	W	(cont)	<b>145054 (1)</b>
R	89-01	6900 All Models with Neway Rear Suspension	
<b>Cab Shock</b>			
<b>83001</b>	C		
	96-11	FREIGHTLINER CENTURY CLASS All Sleeper-Cabs with O.E. Number	
<b>83002</b>	C		
		KENWORTH ADDITIONAL APPLICATIONS	
		AEROCAB	
		ICON 900	
	07-10	T660 All Models with Link Cab Suspension	
	06-24	W900 All Models with Link Cab Suspension	
<b>83003</b>	W		<b>140455 (1)</b>
	89-94	MACK MH All Models with Air Cab	
<b>83004</b>	W		
		VOLVO VARIOUS	
<b>83005</b>	W		<b>140455 (1)</b>
		INTERNATIONAL 4000 SERIES 8000 SERIES	
<b>83006</b>	W		
	96-11	FREIGHTLINER CENTURY CLASS All Day Cab Suspensions with O.E.M. Number	
	96-06	FL70 All Day Cab Suspensions with O.E.M. Number	
	96-06	FL80 All Day Cab Suspensions with O.E.M. Number	
<b>83007</b>	W		<b>140702 (1)</b>
	89-05	MACK CH All Models with O.E.M. Number	
<b>83008</b>	A		
	08-20	PETERBILT 367 All 367 Models with 70" Sleepers	
	99-01	377 All Models with O.E.M. Number	
		379	
	99-07	379 All Models with O.E.M. Number	
	06-16	386 All 386 Models with Sleepers	
	08-15	388 All 388 Models with 70" Sleepers	
	08-24	389 All 389 Models with 52", 72", and 78" Sleepers	
<b>83009</b>	C		
	01-11	FREIGHTLINER CLASSIC All Sleeper Cab models with Air Suspension	
		COLUMBIA	
	91-08	FLD112 All Sleeper Cab models with Air Suspension	
	91-11	FLD120 All Sleeper Cab models with Air Suspension	
		MC NEILLUS TRUCK & MAN. VARIOUS	
		OSHKOSH MOTOR TRUCK CO. VARIOUS	
		VOLVO VARIOUS	
	23-24	WESTERN STAR 57X All Sleeper Cab models with Air Suspension	
<b>83011</b>	W		
		KENWORTH T2000	
<b>83012</b>	W		
	98-11	KENWORTH T2000 All Models with PowerPacker Cab Suspension after 6/28/98	
<b>83013</b>	W		
		INTERNATIONAL 8000 SERIES	
<b>83015</b>	W		<b>140455 (1)</b>
		INTERNATIONAL 9000 SERIES	
<b>83016</b>	W		
		CHEVROLET VARIOUS	
		FORD ADDITIONAL APPLICATIONS	
	89-99	FREIGHTLINER FLA086 All Models with 86", 96" & 104" Cabs with Link Cabmate Model FRT285	
	02	FLB All Models with 86", 96" & 104" Cabs with Link Cabmate Model FRT285	

## Numerical listing

Shock	POP	Alternative No.	MTG Acc. Supplied
Pos.	Year	Application	
<b>83016</b>	W	(cont)	
94-99	FLB	All Models with 86", 96" & 104" Cabs with Link Cabmate Model FRT285 <b>GMC</b> VARIOUS <b>INTERNATIONAL</b> 4000 SERIES	
89-96	9700	All Models with 89" or 110" cabs with Link Cabmate Models IH9789 or IH97110	
81-88	CO9670	All Models with 89" or 110" cabs with Link Cabmate Models IH967-A or IH97110	
81-88	COF9670	All Models with 89" or 110" cabs with Link Cabmate Models IH967-A or IH97110	
81-06	<b>KENWORTH</b> COE MODELS <b>PETERBILT</b> 362	All Models with Link Cabmate Model PB-362-2P <b>VOLVO</b> VARIOUS <b>WESTERN STAR</b> VARIOUS	
<b>83017</b>	W		
89-99	<b>FREIGHTLINER</b> FLA086	All Models with O.E.M. Number	
<b>83018</b>	W	<b>140780 (1)</b>	
81-91	<b>MACK</b> R	All Models with O.E.M. Number	
07	RD	All Models with O.E.M. Number	
81-04	RD	All Models with O.E.M. Number	
<b>83019</b>	W	<b>140780 (1)</b>	
81-91	<b>MACK</b> R	All Models with Cab Air suspension	
07	RD	All Models with Cab Air suspension	
81-04	RD	All Models with Cab Air suspension <b>VOLVO</b> VARIOUS	
<b>83021</b>	C		
90-96	<b>CHEVROLET</b> C70 KODIAK	All Truck Cabs with Link Cabmate Model GMC104TK	
97-09	C6500 KODIAK	All Truck Cabs with Link Cabmate Model GMC104TK	
02-09	C7500 KODIAK	All Truck Cabs with Link Cabmate Model GMC104TK	
97-99	C7500 KODIAK	All Truck Cabs with Link Cabmate Model GMC104TK <b>CNH GLOBAL NV.</b> VARIOUS	
91-06	<b>FREIGHTLINER</b> FL70	All Trucks with Link Cabmate Models FRT153BC-A, FRT106BC or FRT106HD-A	
91-06	FL80	All Trucks with Link Cabmate Models FRT153BC-A, FRT106BC or FRT106HD-A	
94-03	FL106	All Trucks with Link Cabmate Models FRT153BC-A, FRT106BC or FRT106HD-A	
02	FLB	All Trucks with 90", 100", & 110" Cabs with Link Cabmate Models FRT46-2P-A or FRT46-2P-B	
94-99	FLB	All Trucks with 90", 100", & 110" Cabs with Link Cabmate Models FRT46-2P-A or FRT46-2P-B	
90-96	<b>GMC</b> C6000 TOPKICK	All Truck Cabs with Link Cabmate Model GMC104TK	
03-09	C6500 TOPKICK	All Truck Cabs with Link Cabmate Model GMC104TK	
97-99	C6500 TOPKICK	All Truck Cabs with Link Cabmate Model GMC104TK	
90-96	C7000 TOPKICK	All Truck Cabs with Link Cabmate Model GMC104TK	
97-09	C7500 TOPKICK	All Truck Cabs with Link Cabmate Model GMC104TK	
03-09	C8500 TOPKICK	All Truck Cabs with Link Cabmate Model GMC104TK	
89-96	<b>INTERNATIONAL</b> 9700	All Cabovers with 89" & 110" cabs with Link Cabmate Model NAV9876	
96-99	9800 SBA	All Cabovers with 89" & 110" cabs with Link Cabmate Model NAV9876	
81-88	CO9670	All Cabovers with 89" & 110" cabs with Link Cabmate Model NAV9876	
97-21	VARIOUS		

## Cab Shock

Shock	POP	Alternative No.	MTG Acc. Supplied
Pos.	Year	Application	
<b>83021</b>	C	(cont)	
86-08	<b>KENWORTH</b> T600A	All Models with Link Cabmate KWMC642 Air Suspension T800 W900 <b>OSHKOSH MOTOR TRUCK CO.</b> VARIOUS	
10-20	<b>PETERBILT</b> 348	All Day Cab Models with O.E.M. Number	
81-84	348	All Day Cab Models with O.E.M. Number	
86-08	357	All Models with Link Cabmate Models PBC377 & PBC377-A	
81-88	359	All 359 Conventional Truck & Tractors with Link Cabmate Models PBC379 & PBC379-A	
87-96	375	All Models with Link Cabmate Models PBC377 & PBC377-A	
87-01	377	All Models with Link Cabmate Models PBC379 & PBC379-A	
88-07	378	All Models with Link Cabmate Models PBC377 & PBC377-A	
86-07	379	All Models with Link Cabmate Models PBC379 & PBC379-A	
<b>83022</b>	W		
81-02	<b>CNH GLOBAL NV.</b> VARIOUS <b>WESTERN STAR</b> 4800	All Models with O.E.M. Number	
81-02	4900	All Models with O.E.M. Number	
97-02	4900E	All Models with O.E.M. Number	
89-01	6900	All Models with O.E.M. Number VARIOUS	
<b>83023</b>	W		
79-09	<b>CHEVROLET</b> VARIOUS <b>FORD</b> L-SERIES CONVENTIONAL <b>GMC</b> VARIOUS	VARIOUS <b>INTERNATIONAL</b> 4000 SERIES <b>KENWORTH</b> ADDITIONAL APPLICATIONS	
92-99	T400	All Models with Link Cabmate Air Suspension KWB689-A with rear cab support Kenworth P/N K235-1646 T400A	
10-21	T400A		
92-99	T400A		
92	T450		
93-97	T450	All Models with Link Cabmate Air Suspension KWB689-A with rear cab support Kenworth P/N K235-1646 T600A T800 W900	
81-91	<b>MACK</b> R	All Models with Link Cabmate Model MCR600	
81-89	RS	All Models with Link Cabmate Model MCR600	
81-87	<b>PETERBILT</b> 359	All 359 Models (Older Models) Conventional Tractors with Link Cabmate Model PBCAL359 <b>VOLVO</b> VARIOUS	
86-02	<b>WESTERN STAR</b> 4800	All Conventional Tractors with Link Cabmate Model WSC4000	
86-02	4900	All Conventional Tractors with Link Cabmate Model WSC4000	
<b>83024</b>	W		
11-16	<b>KENWORTH</b> COE MODELS	T700 All Models with Extended Sleeper Cab	
97-11	T2000	All Models with Link Cabmate KWT2000-A Air Suspension	
<b>83025</b>	C		
96-06	<b>FORD</b> 8500 SERIES 9500 SERIES ADDITIONAL APPLICATIONS L-SERIES CONVENTIONAL <b>FREIGHTLINER</b> ADDITIONAL APPLICATIONS	FL112 All Day Cab Tractors with Link Cabmate Model FRT112DC	

## Numerical listing

Shock	POP	Alternative No.	MTG Acc. Supplied
Pos.	Year	Application	
<b>83025</b>	C	(cont)	
89-01	FLC112	All Conventional Tractors with Link Cabmate Model FRTE120-A	
91	FLC120	All Conventional Tractors with Link Cabmate Model FRTE120-A	
91-08	FLD112	All Models with O.E.M. Number	
88-11	FLD120	All Models with O.E.M. Number <b>INTERNATIONAL</b> 4000 SERIES 5000 SERIES 7000 SERIES 9000 SERIES	
94-16	9000 SERIES		
93-18	9000 SERIES	VARIOUS <b>KENWORTH</b> ADDITIONAL APPLICATIONS	
86-21	ADDITIONAL APPLICATIONS	C-500B	
92-99	T400	All Models with Link Cabmate KWB689-B or KWB689-C Air Suspension 10-20 T400A 92-99 T400A 92 T450 93-97 T450	
10-20	T400A		
92-99	T400A		
92	T450		
93-97	T450	All Models with Link Cabmate KWB689-B or KWB689-C Air Suspension T600A T800 W900	
78-21	<b>PETERBILT</b> VARIOUS <b>STERLING TRUCK</b> VARIOUS		
<b>83026</b>	D		
97-02	<b>WESTERN STAR</b> 4900	All Day Cab Models 97-02 4900E All Day Cab Models 02-20 4900FA All Day Cab Models 02-20 4900SA All Day Cab Models VARIOUS	
<b>83027</b>	D	<b>140126 (1)</b>	
		<b>WESTERN STAR</b> VARIOUS	
<b>83028</b>	W		
02-21	<b>VOLVO</b> VHD	All VHD Models - With O.E.M. Number VN SERIES - 2200	
<b>83029</b>	W		
	<b>VOLVO</b> VN SERIES	- 2200	
<b>83030</b>	W		
	<b>VOLVO</b> VARIOUS		
<b>83031</b>	C		
06-22	<b>KENWORTH</b> AEROCAB	T800 All Models with 38" Sleeper Cabs	
18	W900	All Models with 38" Sleeper Cabs	
<b>83034</b>	W		
99-08	<b>FORD</b> 9500 SERIES <b>STERLING TRUCK</b> LT9500	All Models with O.E.M. Number	
<b>83035</b>	D		
00-11	<b>PETERBILT</b> 387	All 387 Models with 70" Sleepers	
11-18	587	All 587 Models with 70" Sleepers	
<b>83038</b>	A		
13-16	<b>FREIGHTLINER</b> 122SD	All Crew Cab Models with O.E.M. Number	
13-16	122SD	All Models with O.E.M. Number	
09-19	CASCADIA	All Models with 72" High-Roof Sleeper and 1/2" Top mounting bolt <b>CENTURY CLASS</b>	
00-17	COLUMBIA	All Models with Sleeper Cabs w/O.E.M. Numbers	
01-17	CORONADO	All Models with Sleeper Cabs w/O.E.M. Numbers	
03-22	M2 112	All Crew Cab Models with O.E.M. Number	
03-22	<b>PIERCE MFG. INC.</b> VARIOUS		



## Numerical listing

Shock	POP	Alternative No.	MTG Acc. Supplied
Pos.	Year	Application	
<b>83039</b>	W		
	03-24	<b>FREIGHTLINER</b> M2 112 All Day Cab Models with Leaf Spring Suspensions	
	03-24	<b>PIERCE MFG. INC.</b> VARIOUS	
<b>83040</b>	W		
	12-24	<b>FREIGHTLINER</b> 108SD All Day Cab Models with Spring Suspensions	
	12-24	114SD All Day Cab Models with Spring Suspensions	
	05-06	M2 106 All Day Cab Models with Spring Suspensions	
	02-03	M2 106 All Day Cab Models with Spring Suspensions	
	02-24	<b>PIERCE MFG. INC.</b> VARIOUS	
<b>83041</b>	D		140780 (1)
	89-05	<b>MACK</b> CH All Models with Sleeper Cab	
	91-07	CL All Models with O.E.M number	
	01-08	CV All Models with O.E.M number	
<b>83042</b>	C		
		<b>KENWORTH</b> ADDITIONAL APPLICATIONS	
	10-23	<b>PETERBILT</b> 348 All Conventional Day Cab with O.E.M. Number	
	08-21	365 All Conventional Day Cab with O.E.M. Number	
	08-23	367 All Conventional Day Cab with O.E.M. Number	
	08-16	384 All Conventional Day Cab with O.E.M. Number	
	06-16	386 All Conventional Day Cab with O.E.M. Number	
	06-07	388	
	08-15	388 All Conventional Day Cab with O.E.M. Number	
	08-23	389 All Conventional Day Cab with O.E.M. Number	
<b>83044</b>	W		
	99-15	<b>FREIGHTLINER</b> ARGOSY All Models with O.E.M. Number	
<b>83045</b>	W		140780 (1)
	08-19	<b>MACK</b> CHU All Models with Sleeper Cabs with O.E.M. Number	
	00-05	CX All Models with Sleeper Cabs with O.E.M. Number	
	04-08	CXN All Models with Sleeper Cabs with O.E.M. Number	
	06-07	CXP All Models with Sleeper Cabs with O.E.M. Number	
	08-19	CXU All Models with Sleeper Cabs with O.E.M. Number	
<b>83047</b>	W		
		<b>FREIGHTLINER</b> CENTURY CLASS	
	03-08	FLD112 All D2 Cab Models	
	03-11	FLD120 All D2 Cab Models	
<b>83048</b>	C		
	11-14	<b>VOLVO</b> VAH All Sleepers with O.E.M. Number	
	17-19	VAH 430 All Models with 42" Sleeper Cabs	
	08-09	VHD All VHD Models - With O.E.M. Number	
		VN	
	08-24	VNL All Models with Sleeper Cabs with O.E.M. Number	
	11-15	VNL 300	
	16-20	VNL 300 All Models with Mid-Roof Sleeper Cabs	
	13-14	VNL 430	
	15-16	VNL 430 All Models with Mid-Roof Sleeper Cabs	
	13-14	VNL 630	
	15-16	VNL 630 All Models with Mid-Roof Sleeper Cabs	
	13-14	VNL 670	
	15-16	VNL 670 All Models with Mid-Roof Sleeper Cabs	
	21-24	VNL 740	
	17-20	VNL 740 All Models with Mid-Roof Sleeper Cabs	
	21-24	VNL 760	
	17-20	VNL 760 All Models with Mid-Roof Sleeper Cabs	
	11-19	VNL 780	
		VNM	
	22	VNX	
	18	VNX	

## Cab Shock

Shock	POP	Alternative No.	MTG Acc. Supplied
Pos.	Year	Application	
<b>83048</b>	C (cont)		
	19-21	VNX All VNX 84T-740 Models with High Rise Sleeper Cabs	
	10	VT	
	06-10	VT All All with 60" to 77" Mid - High Roof Sleepers (w/O.E.M. Number)	
<b>83049</b>	D		
		<b>KENWORTH</b> T440	
		T450	
		T600A	
	98-08	T600A All Models with Link Cabmate KWB689-D and Severe service crossmembers	
	98-23	T800 All Models with Link Cabmate KWB689-D and Severe service crossmembers	
	14-18	T880 All Sleeper cab Models with Link Cab Suspension	
	98-23	W900 All Models with Link Cabmate KWB689-D and Severe service crossmembers	
<b>83050</b>	W		140780 (1)
	05-07	<b>MACK</b> CHN All CHN-613 Models with O.E.M. Number	
	08-19	CHU All CHU-613 Models with O.E.M. Number	
	05-07	CT All Models with O.E.M. Number	
		CTX	
	05-08	CXN All CXN-613 Models with O.E.M. Number	
	06-07	CXP All CXP-613 Day Cab Models	
	08-11	CXU All Models with O.E.M. Number	
	15-19	GRANITE All GU713 and GU813 Models with O.E.M. Number	
	08-19	GU7 All GU713 Models with O.E.M. Number	
	08-19	GU8 All GU813 Models with O.E.M. Number	
	18-19	PINNACLE All Models with O.E.M. Number	
<b>83051</b>	D		
	04-09	<b>INTERNATIONAL</b> 9000 SERIES	
<b>83053</b>	W		
		<b>INTERNATIONAL</b> 7000 SERIES	
		8000 SERIES	
	08-09	8500 TRANSTAR All Models Tractors with 36" Sleepers	
	08-09	8600 TRANSTAR All Models Tractors with 36" Sleepers	
<b>83054</b>	W		
	20	<b>INTERNATIONAL</b> 4300 All Models with O.E.M. Number	
	15	4300 All Models with O.E.M. Number	
	19	4300LP All Models with O.E.M. Number	
	10	4300LP All Models with O.E.M. Number	
	02-08	4300LP All Models with O.E.M. Number	
	02-20	4400 All Models with O.E.M. Number	
	10-19	4400LP All Models with O.E.M. Number	
	02-05	4400LP All Models with O.E.M. Number	
	02-20	7300 All Models trucks with day cab or extended cabs with Link Cabmate Model IDC7345	
	02-20	7400 All Models trucks with day cab or extended cabs with Link Cabmate Model IDC7345	
	02-20	7500 All Models trucks with day cab or extended cabs with Link Cabmate Model IDC7345	
	02-07	8500 All Model trucks with day cab or extended cabs with Link Cabmate Model IDC85	
	08-11	8500 TRANSTAR All Model trucks with day cab or extended cabs with Link Cabmate Model IDC85	
	03-07	8600	
	03-07	8600 SBA All Models with O.E.M. Number	
	08-18	8600 TRANSTAR All Models with O.E.M. Number	
	19-23	HV607 All Models with O.E.M. Number	

## Numerical listing

Shock	POP	Alternative No.	MTG Acc. Supplied
Pos.	Year	Application	
<b>83054</b>	W (cont)		
	15-20	WORKSTAR 7300 All Models trucks with day cab or extended cabs with Link Cabmate Model IDC7345	
	15-20	WORKSTAR 7400 All Models trucks with day cab or extended cabs with Link Cabmate Model IDC7345	
	19-23	<b>PIERCE MFG. INC.</b> VARIOUS	
<b>83056</b>	W		
	08-16	<b>KENWORTH</b> AEROCAB	
	16	ICON 900	
	19-20	T660 All Models with 86" Sleepers with O.E.M. Number	
	07-17	T660 All Models with 86" Sleepers with O.E.M. Number	
	11-16	T700 All Models with 86" Sleepers with O.E.M. Number	
	06-22	W900 All Models with 86" Sleepers with O.E.M. Number	
<b>83059</b>	W		
		<b>POWERPACKER</b> VARIOUS	
<b>83062</b>	C		145128 (1)
	12-18	<b>INTERNATIONAL</b> 8600 TRANSTAR All Models with O.E.M. Number	
	09-22	LONESTAR All Models with O.E.M. Number	
	17-23	LT625 All DayCab Models with O.E.M. Number	
	20	LT All DayCab Models with O.E.M. Number	
	11-16	PROSTAR All Models With 56" or 72" Hi Roof Sleeper	
	18-20	RH613 All Models With 56" Hi Roof Sleeper	
<b>83065</b>	W		
	01-15	<b>WESTERN STAR</b> 6900 SX MODELS	
<b>83066</b>	W		
	18-24	<b>MACK</b> ANTHEM All Day Cab Models with O.E.M. Number	
	14-19	CHU All Day Cab Models with O.E.M. Number	
		CXN	
	08-19	CXU All Day Cab Models with O.E.M. Number	
	15-19	GRANITE All GU713 and GU813 Models with O.E.M. Number	
	08-19	GU7 All GU713 Models with O.E.M. Number	
	08-19	GU8 All GU813 Models with O.E.M. Number	
	21-24	MD7 All Models with O.E.M. Number	
	18-22	PINNACLE All Day Cab Models with O.E.M. Number	
<b>83081</b>	C		
	13-24	<b>KENWORTH</b> T680 All Models with Sleepers with O.E.M. Number	
	20-24	T880 All Models with Sleepers with O.E.M. Number (Shock only)	
	19-24	W990 All Models with Sleepers with O.E.M. Number	
	10-20	<b>PETERBILT</b> 348 All Models with Sleepers with O.E.M. Number	
	16-24	567 All Sleeper Cab models with O.E.M. Number (Shocks only)	
	16-24	579 All Sleeper Cab models with O.E.M. Number (Shocks only)	
<b>83901</b>	W		
	12-19	<b>MACK</b> CHU All Models with O.E.M. Number	
	12-19	CXU All Models with O.E.M. Number	
	21-24	GRANITE All Models with O.E.M. Number	
	15-19	GRANITE All Models with O.E.M. Number	
	12-19	GU4 All GU432 Models with O.E.M. Number	
	12-18	GU5 All GU533 Models with O.E.M. Number	
	08-19	GU7 All GU713 Models with O.E.M. Number	
	08-19	GU8 All GU813 Models with O.E.M. Number	
<b>83905</b>	D		
	11-20	<b>VOLVO</b> VAH All VAH DayCab Models with O.E.M. Number	

Numerical listing

Shock	POP	Alternative No.	MTG Acc. Supplied
Pos.	Year	Application	
<b>83905</b>	D	(cont)	
11-24	VHD	All DayCab Models with O.E.M. Number	
18-24	VNL	All VNL 64T-860 Models with High Rise Sleeper Cabs	
11-24	VNL	All VNL 64T-300 DayCab Models with O.E.M. Number	
11-23	VNL	All VNL 42T-300 Models - With O.E.M. Number	
18-19	VNL	All VNL 64T-740 Models with High Rise Sleeper Cabs	
14-19	VNL	All VNL 64T-670 Models with High Rise Sleeper Cabs	
15-18	VNL	All VNL 64T-730 Models with Mid Rise Sleeper Cabs	
15-18	VNL	All VNL 64T-780 Models with High Rise Sleeper Cabs	
21-24	VNL	300	
16-20	VNL	300 All DayCab Models with O.E.M. Number	
15-16	VNL	670 All Sleeper Cab Models with O.E.M. Number	
21-24	VNL	860	
17-20	VNL	860 All Sleeper Cab Models with O.E.M. Number	
13-18	VNM	All VNM 64T-200 Day Cab Models	
16	VNM	All VNM 64T-630 Models with High Rise Sleeper Cabs	
13	VNM	All VNM 42T-200 Day Cab Models	
18-24	VNR	All Day Cab Models with O.E.M. Number	
21-24	VNR	300	
17-20	VNR	300 All Models with O.E.M. Number	
17-24	VNR	400	
17-20	VNR	400 All Models with O.E.M. Number	
17-24	VNR	640	
17-20	VNR	640 All Models with O.E.M. Number	
19-20	VNX	All VNX DayCab Models with O.E.M. Number	
15-17	VNX	All VNX DayCab Models with O.E.M. Number	
<b>83906</b>	C		
17-23	<b>FREIGHTLINER</b>	122SD All Models with O.E.M. Number	
17-21	CASCADIA	All Day Cab and Sleeper cabs w/OEM Number and 12 mm Top mounting bolt	
17-20	COLUMBIA	All Models with Sleeper Cabs w/O.E.M. Numbers	
17-20	CORONADO	All Day Cab and Sleeper Cabs w/O.E.M. Numbers	
<b>83907</b>	W		
20-24	<b>INTERNATIONAL</b>	HX520 All 73" Sleeper, 73" Raised Roof Sleeper Cab	
18-20	HX520	All Sleeper Cab Models with O.E.M. Number	
17-20	HX620	All Sleeper Cab Models with O.E.M. Number	
17-23	LONESTAR	All Sleeper Cab Models with O.E.M. Number	
17-24	LT625	All Sleeper Cab Models with O.E.M. Number	
20	LT	All Sleeper Cab Models with O.E.M. Number	
<b>83908</b>	W		
17-24	<b>KENWORTH</b>	T680 All Day Cab Models with O.E.M. Number	
14-24	T880	All Day Cab Models with O.E.M. Number	
19-24	W990	All Day Cab Models with O.E.M. Number	
18	<b>PETERBILT</b>	348 All Day Cab Models with O.E.M. Number	
16-24	567	All Day Cab Models with O.E.M. Number	
16-23	579	All Day Cab Models with O.E.M. Number	
<b>83909</b>	W		
18-23	<b>INTERNATIONAL</b>	HX520 All Day Cab Models with O.E.M. Number	
17-24	HX620	All Day Cab Models with O.E.M. Number	
<b>83910</b>	W		
18-24	<b>MACK</b>	ANTHEM All Sleeper Cab Models with O.E.M. Number	

Cab Shock, 85000 Series

Shock	POP	Alternative No.	MTG Acc. Supplied
Pos.	Year	Application	
<b>83910</b>	W	(cont)	
18-21	PINNACLE	All Pinnacle 64T Sleeper Cab Models with O.E.M. Number	
18	PINNACLE	All Anthem 64T Sleeper Cab Models with O.E.M. Number	
<b>83911</b>	D		
21-24	<b>FREIGHTLINER</b>	CASCADIA All Cascadia 126 Day Cab and Sleeper cabs w/ 12 mm Top mounting bolt	
21-24	<b>WESTERN STAR</b>	49X All Day Cab Models w/ 12 mm Top mounting bolt	
23-24	57X	All Day Cab Models w/ 12 mm Top mounting bolt	
<b>85000 Series</b>			
<b>85000</b>	A		
R		<b>BENSON TRUCK BODIES INC. VARIOUS</b>	
R		<b>CUSH CORPORATION TRAILER SUSPENSIONS - LOW MOUNT TRAILER SUSPENSIONS - TOP MOUNT</b>	
R		<b>EAST MANUFACTURING CORP. VARIOUS</b>	
R		<b>GREAT DANE TRAILER VARIOUS</b>	
R		<b>HENDRICKSON TRAILER SUSPENSION SYSTEMS</b>	
R		ADDITIONAL APPLICATIONS	
R		INTRAAX	
R		TOP MOUNT STYLE	
R		UNDERSLUNG STYLE	
R		VANTRAAX	
R		<b>MC NEILUS TRUCK &amp; MAN. VARIOUS</b>	
R		<b>ORION BUS VARIOUS</b>	
R		<b>RIDEWELL CORP. TRAILER AIR-RIDES</b>	
R		TRUCK AIR-RIDES	
R		<b>SAF HOLLAND TRAILER AIR SUSPENSION</b>	
R		TRUCK, BUS & MOTORHOME AIR SUSPENSIONS	
R		TRUCK & TRACTOR AIR SUSPENSION (TAG AXLE)	
R		<b>STOUGHTON TRAILERS INC. VARIOUS</b>	
R		<b>THOMAS VARIOUS</b>	
R		<b>TRAILMOBILE CANADA CORP. VARIOUS</b>	
R		<b>TWIN COACH VARIOUS</b>	
R		<b>UTILITY TRAILER MANUFACTURING COMPANY</b>	
R		FLATBEDS	
R		REEFERS & DRY VANS	
R		<b>WABASH NATIONAL VARIOUS</b>	
R		<b>WATSON &amp; CHALIN MFG. INC. VARIOUS</b>	
<b>85001</b>	B	<b>401754 (4)</b>	
R	96-98	<b>FORD</b> A9513 All Models with 21000 lb or 23000 lb Axle and 46" Taperleaf spring	
R	97	A9522 All Models with 21000 lb or 23000 lb Axle and 46" Taperleaf spring	
R	96-98	AT9513 All Models with 21000 lb or 23000 lb Axle and 46" Taperleaf spring	
R	97-98	AT9522 All Models with 21000 lb or 23000 lb Axle and 46" Taperleaf spring	
R	94-97	B - SERIES - BUS COWL CHASSIS	
R	94-97	F-800 All Models with 21000 Taperleaf Springs	
R	94-98	FT900 All Models with 46" Taperleaf Springs and 21000 lb Axle	
R	94-97	L8000F All Models with 21000 or 23000 lb. with 46" Taperleaf Spring	
R	94-97	L9000 All Models with 21000 or 23000 lb. with 46" Taperleaf Spring	
R	94-97	LN7000 All Models with 21000 or 23000 lb. with 46" Taperleaf Spring	
R	94-97	LN8000 All Models with 21000 or 23000 lb. with 46" Taperleaf Spring	
R	94-97	LN9000 All Models with 21000 or 23000 lb. with 46" Taperleaf Spring	
R	94-97	LNT8000F All Models with 21000 or 23000 lb. with 46" Taperleaf Spring	
R	94-97	LNT9000 All Models with 21000 or 23000 lb. with 46" Taperleaf Spring	
R	94-97	LT9000 All Models with 21000 or 23000 lb. with 46" Taperleaf Spring	

Numerical listing

Shock	POP	Alternative No.	MTG Acc. Supplied
Pos.	Year	Application	
<b>85001</b>	B	(cont)	
F	18-19	<b>KENWORTH</b> C500 All Models with Taper Leaf Springs on Front Axle	
F	85-16	C500 All Models with Taper Leaf Springs on Front Axle	
F	92-93	C540 All Models with Taper Leaf Springs on Front Axle	
F	88-90	C540 All Models with Taper Leaf Springs on Front Axle	
F	85-94	C550 All Models with Taper Leaf Springs on Front Axle	
F	16-17	ICON 900	
F	05-06	K100E All Models with Taper Leaf Springs on Front Axle	
F	85-03	K100E All Models with Taper Leaf Springs on Front Axle	
F	93-05	K300 All Models with Taper Leaf Springs on Front Axle (1" Mounting bolts)	
F		T300	
F	10-22	T400 All Models with Taper Leaf Springs on Front Axle	
F	89-99	T400 All Models with Taper Leaf Springs on Front Axle	
F	93-97	T450 All Models with Taper Leaf Springs on Front Axle	
F	86-08	T600A All Models with Taper Leaf Springs on Front Axle	
F	10-22	T800 All Models with Taper Leaf Springs on Front Axle	
F	87-99	T800 All Models with Taper Leaf Springs on Front Axle	
F	97-11	T2000 All Models with Taper Leaf Springs on Front Axle	
F	10-24	W900 All Models with Taper Leaf Springs on Front Axle	
F	87-99	W900 All Models with Taper Leaf Springs on Front Axle	
F	89-05	<b>MACK</b> CH All CH600 Models with ST34 Suspension	
F	91-07	CL All CL600, CL700 Models with ST34 Suspension	
F	83-94	MH All MH Models with O.E.M. Number	
F	83-85	R All RD Models with ST34 Suspension	
F	85-93	RW All RW Models with O.E.M. Number	
R		<b>TUTHILL TECHNOLOGIES TRAILER</b>	
<b>85003</b>	B		
R		<b>IC CORPORATION</b> RE SCHOOL BUS	
R		<b>INTERNATIONAL</b> F & S SERIES	
R		SERIES 1000 FORWARD CONTROL CHASSIS	
R		SERIES 2000 - CONVENTIONAL TRUCK (SEVERE SERVICE)	
R		SERIES 3000 - SCHOOL BUS CHASSIS	
R		SERIES 4000 - SHORT CONVENTIONAL MEDIUM TRK & TRAC	
R		SERIES 7000 - SHORT CONV. MEDIUM TRUCK & TRACTOR	
R		SERIES 8000 - CONVENTIONAL HEAVY DUTY TRACTOR	
R		SERIES 9100, 9100I - TRACTOR & STRAIGHT TRUCK	
R		SERIES 9200, 9200I - TRACTOR & STRAIGHT TRUCK	
R		SERIES 9300, 9300I, 9400 & 9400I LONG HOOD CONV.	
R		SERIES 9600 & 9700 PREMIUM CABOVER TRACTOR	
R		SERIES 9800 - PREMIUM CABOVER TRACTOR	
R		SERIES 9900, 9900I, 9900IX LONG HOOD CONV. TRUCK	
R		S SERIES SCHOOL BUS	
<b>85004</b>	W	<b>401754 (4)</b>	
R	87-08	<b>PETERBILT</b> 357 All Models with Neway ARD 125/244-8 Models Rear Air Suspension	
R	81-06	362 All Models with Neway ARD 125/244-8 Models Rear Air Suspension	
R	89-93	372 All Models with Neway ARD 125/244-8 Models Rear Air Suspension	
R	87-96	375 All Models with Neway ARD 125/244-8 Models Rear Air Suspension	

## Numerical listing

Shock	POP	Alternative No.	MTG Acc. Supplied
Pos.	Year	Application	
<b>85004</b>	W (cont)	401754 (4)	
R	99	376 All Models with Neway ARD 125/244-8 Models Rear Air Suspension	
R	94-96	376 All Models with Neway ARD 125/244-8 Models Rear Air Suspension	
R	88-92	376 All Models with Neway ARD 125/244-8 Models Rear Air Suspension	
R	87-01	377 All Models with Neway ARD 125/244-8 Models Rear Air Suspension	
R	88-07	378 All Models with Neway ARD 125/244-8 Models Rear Air Suspension	
R		385	
R		<b>SAF HOLLAND TRUCK, BUS &amp; MOTORHOME AIR SUSPENSIONS</b>	
<b>85005</b>	C		
F		<b>AUTOCAR LLC. ADDITIONAL APPLICATIONS</b>	
R		<b>BLUE BIRD ADDITIONAL APPLICATIONS</b>	
R		ALL AMERICAN SERIES (FE & RE MODELS)	
R		<b>BOYDSTUN EQUIPMENT MANUFACTURING VARIOUS</b>	
R		<b>CUSH CORPORATION VARIOUS</b>	
R		<b>EAST MANUFACTURING CORP. VARIOUS</b>	
R	19-23	<b>ENTEGR COACH EMBLEM</b> All MotorHomes with Ford F53 Chassis with 24,000 lb GVW to 26,000 lb GVW	
R	20-23	VISION XL All MotorHomes with Ford F53 Chassis with 24,000 lb GVW to 26,000 lb GVW	
R	08-23	<b>FLEETWOOD BOUNDER</b> All MotorHomes with Ford F53 Chassis with 24,000 lb GVW to 26,000 lb GVW	
R	20-23	FORTIS All MotorHomes with Ford F53 Chassis with 24,000 lb GVW to 26,000 lb GVW	
R	08-23	SOUTHWIND All MotorHomes with Ford F53 Chassis with 24,000 lb GVW to 26,000 lb GVW	
R	08-23	<b>FORD F-53</b>	
R	08-23	F-53 MOTORHOME CHASSIS All MotorHomes with Ford F53 Chassis with 24,000 lb GVW to 26,000 lb GVW	
F		<b>FREIGHTLINER BUS CHASSIS VARIOUS</b>	
F		GMC 6000 SERIES	
F		<b>HENDRICKSON TRAILER SUSPENSION SYSTEMS</b>	
R		ADDITIONAL APPLICATIONS	
R		TOP MOUNT STYLE	
R		UNDERSLUNG STYLE	
R		<b>INTERNATIONAL SERIES 8000 - CONVENTIONAL HEAVY DUTY TRACTOR</b>	
R		SERIES 9100, 9100I - TRACTOR & STRAIGHT TRUCK	
R		SERIES 9200, 9200I - TRACTOR & STRAIGHT TRUCK	
R		SERIES 9300, 9300I, 9400 & 9400I LONG HOOD CONV.	
R		SERIES 9600 & 9700 PREMIUM CABOVER TRACTOR	
R		SERIES 9800 - PREMIUM CABOVER TRACTOR	
F	89-05	<b>MACK CH</b> All CH600 Models with 12000 lb Taperleaf Spring	
F	91-07	CL All CL600, CL700 Models with Steering Axle & Taperleaf Spring	
F	98-05	CX All Models with 12000 lb Taperleaf Front Suspension	
F	83-94	MH All MH Models with O.E.M. Number	
F	85-93	RW All RW Models with O.E.M. Number	
R		<b>REYCO SUSPENSION DRIVE AXLE</b>	
F		STEER AXLE	
R		<b>RIDEWELL CORP. TRAILER AIR-RIDES</b>	
R		TRUCK AIR-RIDES	
R		<b>SAF HOLLAND TRUCK &amp; TRACTOR AIR SUSPENSION (TAG AXLE)</b>	

## 85000 Series

Shock	POP	Alternative No.	MTG Acc. Supplied
Pos.	Year	Application	
<b>85005</b>	C (cont)		
F		<b>TUTHILL TECHNOLOGIES STEER AXLE</b>	
R		TRAILER	
R		<b>WATSON &amp; CHALIN MFG. INC. LWSL-1100-SR SELF STEER AXLE SUSPENSION</b>	
R		TRAILER AIR SUSPENSION	
R		WCTA SERIES DUMP TRAILER AIR SUSPENSION	
R		WCTA SERIES TRAILER AIR SUSPENSION	
R	89-21	WCTL-2200 SERIES TRAILER AIR LIFT	
R		WCWB SERIES TRAILER AIR SUSPENSION	
<b>85006</b>	B		
R		<b>BLUE BIRD ADDITIONAL APPLICATIONS</b>	
R	89-24	ALL AMERICAN FE All Buses with Comfort Air Suspensions	
R	89-24	ALL AMERICAN RE All Buses with Comfort Air Suspensions	
R	10-13	D3 SERIES (FE & RE MODELS)	
R	89-04	TC2000 All Buses with Standard Flat Leaf Rear Springs	
R	04-24	VISION SCHOOL BUS All Buses with Comfort Air Suspensions	
R		<b>BUILT RITE VARIOUS</b>	
R		<b>DEXTER AXLE TRAILER</b>	
F	19-24	<b>ENTEGR COACH EMBLEM</b> All MotorHomes with Ford F53 Chassis with 24,000 lb GVW to 26,000 lb GVW	
F	20-24	VISION XL All MotorHomes with Ford F53 Chassis with 24,000 lb GVW to 26,000 lb GVW	
F	08-24	<b>FLEETWOOD BOUNDER</b> All MotorHomes with Ford F53 Chassis with 24,000 lb GVW to 26,000 lb GVW	
F	20-24	FORTIS All MotorHomes with Ford F53 Chassis with 24,000 lb GVW to 26,000 lb GVW	
F	08-23	SOUTHWIND All MotorHomes with Ford F53 Chassis with 24,000 lb GVW to 26,000 lb GVW	
F	08-23	<b>FORD F-53</b>	
F	24	F-53 MOTORHOME CHASSIS	
F	08-23	F-53 MOTORHOME CHASSIS All MotorHomes with Ford F53 Chassis with 24,000 lb GVW to 26,000 lb GVW	
F	24	F-59 COMMERCIAL STRIPPED CHASSIS	
F	90-97	L8000F All Models with 52" Taperleaf Spring	
F	91-97	L9000 All Models with 52" Taperleaf Spring	
F	92-97	LLA9000 All Models with 4500, 5400, 6500 lb 58" Parabolic Taperleaf Spring	
F	90-97	LN7000 All Models with 52" Taperleaf Spring	
F	90-97	LN8000 All Models with 52" Taperleaf Spring	
F	90-97	LN9000 All Models with 52" Taperleaf Spring	
F	90-97	LNT8000F All Models with 52" Taperleaf Spring	
F	90-97	LNT9000 All Models with 52" Taperleaf Spring	
F	91-97	LT9000 All Models with 52" Taperleaf Spring	
F	92-97	LTLA9000 All Models with 4500, 5400, 6500 lb 58" Parabolic Taperleaf Spring	
F		<b>FREIGHTLINER BUS CHASSIS</b>	
F	97-08	BUS CHASSIS	
F	05-07	FC70	
F	99-04	FC70 All Models with 10,000 to 18,000 lb Suspension	
F	99-07	FC80 All Models with 10,000 to 18,000 lb Suspension	
F	91-06	FL70 All Models with 10,000 to 18,000 lb Suspension	
F	91-06	FL80 All Models with 10,000 to 18,000 lb Suspension	
R		<b>GREAT DANE TRAILER VARIOUS</b>	
R		<b>HENDRICKSON TRUCK SUSPENSION SYSTEMS</b>	
R		COMFORT AIR - SERIES	
R		<b>RAMERIZ TRAILER TRAILER</b>	

## Numerical listing

Shock	POP	Alternative No.	MTG Acc. Supplied
Pos.	Year	Application	
<b>85006</b>	B (cont)		
R		<b>REYCO SUSPENSION DRIVE AXLE</b>	
R		TRAILER	
R		<b>RIDEWELL CORP. TRAILER AIR-RIDES</b>	
R		<b>SAF HOLLAND TRUCK, BUS &amp; MOTORHOME AIR SUSPENSIONS</b>	
R		TRUCK & TRACTOR AIR SUSPENSION (TAG AXLE)	
F		<b>STERLING TRUCK ACTERRA</b>	
R		<b>STOUGHTON TRAILERS INC. VARIOUS</b>	
R	97	<b>THE BINKLEY COMPANY</b>	
R		VARIOUS	
R		<b>THOMAS VARIOUS</b>	
F	03	VARIOUS	
R		<b>TRAILMOBILE CANADA CORP. VARIOUS</b>	
R		<b>TUTHILL TECHNOLOGIES DRIVE AXLE</b>	
R		TRAILER	
<b>85007</b>	W	401754 (4)	
R	89-99	<b>FREIGHTLINER FLA086</b> All Models with Convoluted Spring Air Suspension	
R	02	FLB All Models with Convoluted Spring Air Suspension	
R	94-99	FLB All Models with Convoluted Spring Air Suspension	
R	85-01	FLC112 All Models with Convoluted Spring Air Suspension	
R	91	FLC120 All Models with Convoluted Spring Air Suspension	
R	81-88	FLC120 All Models with Convoluted Spring Air Suspension	
R	91-08	FLD112 All Models with Convoluted Spring Air Suspension	
R	88-11	FLD120 All Models with Convoluted Spring Air Suspension	
R	05-12	FLD120SD All Models with Convoluted Spring Air Suspension	
R	03	FLD120SD All Models with Convoluted Spring Air Suspension	
R	03-11	FLD132 All Models with Convoluted Spring Air Suspension	
R	01	FLD132 All Models with Convoluted Spring Air Suspension	
F	93-05	<b>KENWORTH K3000</b> All K300 COE Medium Duty	
R	89-05	<b>MACK CH</b> All Models with O.E.M. Number	
R	83-94	MH All MH Models with Taperleaf Rear Suspension	
R	85-93	RW All RW Models with Taperleaf Rear Suspension	
R		<b>REYCO SUSPENSION DRIVE AXLE</b>	
R	97-00	<b>SPARTAN MOTORS K2</b> All Models with O.E.M. Number	
R	97-00	MOUNTAIN MASTER All Models with O.E.M. Number	
R		<b>TUTHILL TECHNOLOGIES DRIVE AXLE</b>	
<b>85009</b>	W	145054 (1)	
F	89-93	<b>MITSUBISHI FUSO FM</b> All FM557 Models with O.E.M. Number	
F	88-91	FM All FM555 Models with O.E.M. Number	
F		<b>NEOPLAN VARIOUS</b>	
R		<b>WATSON &amp; CHALIN MFG. INC. VARIOUS</b>	
<b>85010</b>	W		
R	89-04	<b>BLUE BIRD TC2000</b> All Buses with Ridewell Rear Suspension with O.E.M. Number	
R	11-20	<b>FORD F-53</b>	
R	11-20	F-53 MOTORHOME CHASSIS All F53 Stripped Chassis With BT Delivery Van Pack, 16,000 LB. GVW	
R	88	F-59 COMMERCIAL STRIPPED CHASSIS All F59 Commercial Chassis with 16,000 lb or 19,500 GVW	
R		<b>HENDRICKSON TRAILER SUSPENSION SYSTEMS TOP MOUNT STYLE</b>	
R		UNDERSLUNG STYLE	
R	89-05	<b>MACK CH</b> All CH600 Models with AL Suspension	
R	89-91	R All RB 600 Models (Drive Axle)	



# Numerical listing

Shock	POP	Alternative No.	MTG Acc. Supplied
Pos.	Year	Application	
<b>85010</b>	W	(cont)	
F	00-03	<b>MONACO COACH CLASS A MOTORHOMES</b>	
<b>85012</b>	B	145080 (2)	
F		<b>BLUE BIRD ADDITIONAL APPLICATIONS</b>	
F		<b>BROCKWAY SCHOOL BUS VARIOUS</b>	
F		<b>CHANCE COACH TRANSIT BUS VARIOUS</b>	
F	57-76	<b>FORD MOTORHOME CHASSIS INTERNATIONAL A, B, AC AND BC CONVENTIONAL</b>	
R		A, B, AC AND BC CONVENTIONAL	
F		LOADSTAR - CONVENTIONAL	
R		LOADSTAR - CONVENTIONAL	
F		METRO & MULTI-SHOP SERIES	
R		METRO & MULTI-SHOP SERIES	
F		S SERIES SCHOOL BUS	
R		S SERIES SCHOOL BUS	
R	85	<b>ISUZU ADDITIONAL APPLICATIONS</b>	
F	19-24	<b>KENWORTH W990 All Models with 14,600 lb Taperleaf Front Spring Suspension</b>	
F	13	<b>PETERBILT 220 All Models with 12,000 lb Front Axle</b>	
F	10	<b>220 All Models with 12,000 lb Front Axle</b>	
F	07	<b>220 All Models with 12,000 lb Front Axle</b>	
F	07-16	<b>330 All Models with 12000 lb Set Back Front Axle</b>	
F	95-05	<b>330 All Models with 12000 lb Set Back Front Axle</b>	
F	05-10	<b>335 All Models with 12000 lb Set Back Front Axle</b>	
F	07-10	<b>340 All Models with 12000 lb Set Back Front Axle</b>	
F	87-08	<b>357 All Conventional Models with Spring Suspension and with Set Back Front Axle.</b>	
F	81-06	<b>362 All C.O.E. Models with Progressive Springs</b>	
F	08-15	<b>365 All Models with 12,000 lb to 16,000 lb Taperleaf Front Suspension (Set-Back Axle)</b>	
F	08-16	<b>367 All Models with 10,000 lb to 16,000 lb Taperleaf Front Spring Suspension and with Set Back Front Axle.</b>	
F	89-93	<b>372 All C.O.E. Models with Front Spring Suspension</b>	
F	87-96	<b>375 All Conventional Models with Spring Suspension and with Set Back Front Axle.</b>	
F	99	<b>376 All Conventional Models with Spring Suspension and with Set Back Front Axle.</b>	
F	94-96	<b>376 All Conventional Models with Spring Suspension and with Set Back Front Axle.</b>	
F	88-92	<b>376 All Conventional Models with Spring Suspension and with Set Back Front Axle.</b>	
F	87-01	<b>377 All Conventional Models with Spring Suspension and with Set Back Front Axle.</b>	
F	88-07	<b>378 All Conventional Models with Spring Suspension and with Set Back Front Axle.</b>	
F	86-07	<b>379 All Conventional Models with Spring Suspension and with Set Back Front Axle.</b>	
F	95-07	<b>385 All Conventional Models with Spring Suspension and with Set Back Front Axle.</b>	
F	06-16	<b>386 All Conventional Models with Spring Suspension and with Set Back Front Axle.</b>	
F	00-11	<b>387 All Conventional Models with Spring Suspension and with Set Back Front Axle.</b>	
F	08-15	<b>388 All Conventional Models with Spring Suspension and with Set Back Front Axle.</b>	
F	08-21	<b>389 All Conventional Models with Spring Suspension and with Set Back Front Axle.</b>	
<b>85013</b>	C	(cont)	
R		<b>BLUE BIRD ADDITIONAL APPLICATIONS</b>	

# 85000 Series

Shock	POP	Alternative No.	MTG Acc. Supplied
Pos.	Year	Application	
<b>85013</b>	C	(cont)	
R	96-98	<b>FORD A9513 All All with Hendrickson HAS-400, HA-210 or HA-230 Air Suspension</b>	
R	97	<b>A9522 All All with Hendrickson HAS-400, HA-210 or HA-230 Air Suspension</b>	
R	96-98	<b>AT9513 All All with Hendrickson HAS-400, HA-210 or HA-230 Air Suspension</b>	
R	97-98	<b>AT9522 All All with Hendrickson HAS-400, HA-210 or HA-230 Air Suspension</b>	
F	11-20	F-53	
F	11-20	F-53 MOTORHOME CHASSIS All F53 Stripped Chassis Commercial Stripped Chassis, 19,500 lb to 22,000 lb GVW	
F	88	F-59 COMMERCIAL STRIPPED CHASSIS All F59 Commercial Chassis with 16,000 lb to 22,000 GVW	
R	91-97	<b>LA8000F All All with Hendrickson HAS-400, HA-210 or HA-230 Air Suspension</b>	
R	91-97	<b>LA9000 All All with Hendrickson HAS-400, HA-210 or HA-230 Air Suspension</b>	
R	92-97	<b>LLA9000 All Models with Hendrickson Rear Air Suspension LOUISVILLE SERIES - CONVENTIONAL CAB</b>	
R	91-97	<b>LTA9000 All Models with Hendrickson Rear Air Suspension</b>	
R	92-97	<b>LTLA9000 All Models with Hendrickson Rear Air Suspension</b>	
R		<b>HENDRICKSON TRAILER SUSPENSION SYSTEMS UNDERSLUNG STYLE INTERNATIONAL SERIES 4000 - SHORT CONVENTIONAL MEDIUM TRK &amp; TRAC SERIES 9800 - PREMIUM CABOVER TRACTOR</b>	
R		<b>MC NEILUS TRUCK &amp; MAN. VARIOUS</b>	
R	13-22	<b>PETERBILT 220 All Models with Reyco 102AR (Standard) Rear Air Suspension</b>	
R	10	<b>220 All Models with Reyco 102AR (Standard) Rear Air Suspension</b>	
R	07	<b>220 All Models with Reyco 102AR (Standard) Rear Air Suspension</b>	
R	87-18	<b>320 All Models with Reyco 102AR (Standard) Rear Air Suspension</b>	
R	07-21	<b>330 All Models with Reyco 102AR (Standard) Rear Air Suspension</b>	
R	95-05	<b>330 All Models with Reyco 102AR (Standard) Rear Air Suspension</b>	
R	10-21	<b>337 All Models with Reyco 102AR (Standard) Rear Air Suspension</b>	
R	10-21	<b>348 All Models with Reyco 102AR (Standard) Rear Air Suspension</b>	
F	86-08	<b>357 All Conventional Models with Front Air Suspension and Set Back Front Axle.</b>	
R	10-19	<b>365 All Models with Reyco 102AR (Standard) Rear Air Suspension</b>	
F	89-93	<b>372 All C.O.E. Models with Front Air Suspension</b>	
F	87-96	<b>375 All Conventional Models with Front Air Suspension and Set Back Front Axle.</b>	
F	99	<b>376 All Conventional Models with Front Air Suspension and Set Back Front Axle.</b>	
F	94-96	<b>376 All Conventional Models with Front Air Suspension and Set Back Front Axle.</b>	
F	88-92	<b>376 All Conventional Models with Front Air Suspension and Set Back Front Axle.</b>	
F	87-01	<b>377 All Conventional Models with Front Air Suspension and Set Back Front Axle.</b>	
F	88-07	<b>378 All Conventional Models with Front Air Suspension and Set Back Front Axle.</b>	
F	86-07	<b>379 All Conventional Models with Front Air Suspension and Set Back Front Axle.</b>	
R	11-17	<b>382 All Models with Reyco 102AR (Standard) Rear Air Suspension</b>	

# Numerical listing

Shock	POP	Alternative No.	MTG Acc. Supplied
Pos.	Year	Application	
<b>85013</b>	C	(cont)	
F	06-16	<b>386 All Conventional Models with Front Air Suspension and Set Back Front Axle.</b>	
F	00-11	<b>387 All Conventional Models with Front Air Suspension and Set Back Front Axle.</b>	
F	08-15	<b>388 All Conventional Models with Front Air Suspension and Set Back Front Axle.</b>	
F	08-22	<b>389 All Conventional Models with Front Air Suspension and Set Back Front Axle.</b>	
R	17-22	<b>520 All Models with Reyco 102AR (Standard) Rear Air Suspension</b>	
R	13-22	<b>579 All Models with Reyco 102AR (Standard) Rear Air Suspension</b>	
R	11-18	<b>587 All Models with Reyco 102AR (Standard) Rear Air Suspension</b>	
R		<b>REYCO SUSPENSION DRIVE AXLE</b>	
R		<b>SAF HOLLAND TRUCK &amp; TRACTOR AIR SUSPENSION (TAG AXLE)</b>	
R	91-92	<b>SPARTAN MOTORS MOTORHOME All Models with Tuthill 102 AR Air Suspension</b>	
R	93-95	<b>MOUNTAIN MASTER All Models with Tuthill 102 AR Air Suspension</b>	
R	99-10	<b>STERLING TRUCK A9500 All Models with Hendrickson HAS Rear Air Suspension</b>	
R	99-01	<b>A9513 All Models with Hendrickson HAS Rear Air Suspension</b>	
R	99	<b>A9522 All Models with Hendrickson HAS Rear Air Suspension</b>	
R	99-10	<b>L8500 All Models with Hendrickson HAS Rear Air Suspension</b>	
R	99	<b>L8501 All Models with Hendrickson HAS Rear Air Suspension</b>	
R	99-01	<b>L8513 All Models with Hendrickson HAS Rear Air Suspension</b>	
R	99-10	<b>L9500 All Models with Hendrickson HAS Rear Air Suspension</b>	
R	99-00	<b>L9501 All Models with Hendrickson HAS Rear Air Suspension</b>	
R	99-01	<b>L9511 All Models with Hendrickson HAS Rear Air Suspension</b>	
R	99-00	<b>L9513 All Models with Hendrickson HAS Rear Air Suspension</b>	
R	99	<b>L9522 All Models with Hendrickson HAS Rear Air Suspension</b>	
R		<b>TRAILMOBILE CANADA CORP. VARIOUS</b>	
R		<b>TUTHILL TECHNOLOGIIES DRIVE AXLE</b>	
<b>85014</b>	D	(cont)	
F		<b>CHANCE COACH TRANSIT BUS VARIOUS</b>	
R		<b>CUSH CORPORATION VARIOUS</b>	
R		<b>HARDEE MFG. VARIOUS</b>	
R		<b>HENDRICKSON TRAILER SUSPENSION SYSTEMS TOP MOUNT STYLE</b>	
R		<b>UNDERSLUNG STYLE</b>	
F	89-05	<b>MACK CH All Models with O.E.M. Number</b>	
F	04-07	<b>CHN All CHN-613 Models with 14,600 lb Front Axle</b>	
F	08-19	<b>CHU All CHU-613 Models with 12,000 lb or 14,600 lb Front Axle</b>	
F	04-08	<b>CXN All Models with O.E.M. Number</b>	
F	15-17	<b>GRANITE All Models with 12,000 lb or 14,600 lb Front Axle</b>	
F	12-19	<b>GU4 All GU432 Models with 12,000 lb or 14,600 lb Front Axle</b>	
F	12-18	<b>GU5 All GU533 Models with 12,000 lb or 14,600 lb Front Axle</b>	
F	19-22	<b>PINNACLE All Models with 12,000 lb or 14,600 lb Front Axle</b>	
R		<b>RIDEWELL CORP. TRAILER AIR-RIDES</b>	
R		<b>TRUCK AIR-RIDES</b>	
R		<b>SAF HOLLAND TRAILER AIR SUSPENSION</b>	
R		<b>TRUCK, BUS &amp; MOTORHOME AIR SUSPENSIONS</b>	
F		<b>THOMAS VARIOUS</b>	
R		<b>TUTHILL TECHNOLOGIIES TRAILER</b>	
R		<b>WATSON &amp; CHALIN MFG. INC. VARIOUS</b>	



## Numerical listing

Shock	POP	Alternative No.	MTG Acc. Supplied
Pos.	Year	Application	
85023	D		140149 (1)
R		<b>VOLVO FE SERIES</b>	
85024	W		140149 (1)
R		<b>AUTOCAR LLC. ADDITIONAL APPLICATIONS</b>	
R		<b>INTERNATIONAL VARIOUS</b>	
R		<b>VOLVO WCA &amp; WIA SERIES</b>	
R		<b>WG SERIES</b>	
R		<b>WH SERIES</b>	
85026	W		145054 (1)
F		<b>AUTOCAR LLC. ADDITIONAL APPLICATIONS</b>	
F		<b>VOLVO WCA &amp; WIA SERIES</b>	
F		<b>WG SERIES</b>	
F		<b>WH SERIES</b>	
85027	W		145054 (2)
F		<b>AUTOCAR LLC. ADDITIONAL APPLICATIONS</b>	
F		<b>INTERNATIONAL SERIES 4000 - SHORT CONVENTIONAL MEDIUM TRK &amp; TRAC</b>	
F		<b>SERIES 7000 - SHORT CONV. MEDIUM TRUCK &amp; TRACTOR</b>	
F		<b>VOLVO WCA &amp; WIA SERIES</b>	
F		<b>WG SERIES</b>	
85029	B		
F	89-04	<b>BLUE BIRD TC2000</b> All Buses with Ridewell Front Suspension with O.E.M. Number	
R	06	<b>COACHMEN CROSS COUNTRY</b>	
R	03-05	<b>CROSS COUNTRY ELITE</b>	
R	03-05	<b>CROSS COUNTRY SE</b>	
F	00-10	<b>COUNTRY COACH AFFINITY</b> All MotorHomes with Neway IFS	
F	00	<b>CONCEPT</b> All MotorHomes with Neway IFS	
F	00-04	<b>MAGNA</b> All MotorHomes with Neway IFS	
F	05-10	<b>MAGNA 630</b> All MotorHomes with Neway IFS	
R		<b>DURA SUSPENSION VARIOUS</b>	
R		<b>EAST MANUFACTURING CORP. VARIOUS</b>	
R	02-06	<b>FLEETWOOD BOUNDER</b> All MotorHomes with Freightliner XC Chassis and ADL200 Suspension w/ 20K Rear	
R	02-06	<b>DISCOVERY</b> All MotorHomes with Freightliner XC Chassis and ADL200 Suspension w/ 20K Rear	
R	02-06	<b>EXCURSION</b> All MotorHomes with Freightliner XC Chassis and ADL200 Suspension w/ 20K Rear	
R	04-06	<b>PROVIDENCE</b> All MotorHomes with Freightliner XC Chassis and ADL200 Suspension w/ 20K Rear	
R	02-04	<b>FOREST RIVER REFLECTION</b>	
R	02-06	<b>TSUNAMI</b>	
R	03-12	<b>FREIGHTLINER VC CHASSIS</b>	
R	03-12	<b>XC CHASSIS</b>	
R	03-06	<b>GULF STREAM ATRIUM</b>	
R	02-06	<b>FRIENDSHIP</b>	
R	02-06	<b>SCENIC CRUISER</b>	
R		<b>HENDRICKSON TRAILER SUSPENSION SYSTEMS</b>	
R		<b>ADDITIONAL APPLICATIONS</b>	
R		<b>CONNEX</b>	
R		<b>INTRAAX</b>	
R		<b>TOP MOUNT STYLE</b>	
R		<b>UNDERSLUNG STYLE</b>	
R	95-03	<b>HOLIDAY RAMBLER CLASS A MOTORHOMES</b>	
F		<b>INTERNATIONAL SERIES 9300, 9300I, 9400 &amp; 9400I LONG HOOD CONV. TRUCK</b>	
F		<b>SERIES 9900, 9900I, 9900IX LONG HOOD CONV. TRUCK</b>	
R	02-06	<b>ITASCA CLASS A MOTORHOMES</b>	
R	04-06	<b>KING OF THE ROAD CLASS A MOTORHOMES</b>	
R	04-06	<b>MANDALAY COACH CLASS A MOTORHOMES</b>	
R	95-99	<b>MONACO COACH VARIOUS</b>	
R	02-06	<b>NEWMAR CLASS A MOTORHOMES</b>	
R		<b>PAGE SUSPENSION VARIOUS</b>	
R		<b>SAF HOLLAND TRAILER AIR SUSPENSION</b>	
R	97-00	<b>SPARTAN MOTORS ALPINE</b> All MotorHome Chassis with O.E.M. Number	
R	97-00	<b>VARIOUS</b>	

## 85000 Series

Shock	POP	Alternative No.	MTG Acc. Supplied
Pos.	Year	Application	
85029	B (cont)		
R	02-06	<b>THOR MOTOR COACH CLASS A MOTORHOMES</b>	
R		<b>TRAILMOBILE CANADA CORP. VARIOUS</b>	
R		<b>WATSON &amp; CHALIN MFG. INC. VARIOUS</b>	
85030	C		
F		<b>BLUE BIRD ADDITIONAL APPLICATIONS</b>	
R		<b>WANDERLODGE</b>	
R		<b>EAST MANUFACTURING CORP. VARIOUS</b>	
F	96-98	<b>FORD A9513</b> All All with 13200 lb or 14600 lb Axle and 54" Taperleaf Spring	
F	97	<b>A9522</b> All All with 13200 lb or 14600 lb Axle and 54" Taperleaf Spring	
F	96-98	<b>AT9513</b> All All with 13200 lb or 14600 lb Axle and 54" Taperleaf Spring	
F	97-98	<b>AT9522</b> All All with 13200 lb or 14600 lb Axle and 54" Taperleaf Spring	
F	96-98	<b>LOUISVILLE SERIES - CONVENTIONAL CAB</b>	
R		<b>HENDRICKSON TRAILER SUSPENSION SYSTEMS</b>	
R		<b>ADDITIONAL APPLICATIONS</b>	
R		<b>TOP MOUNT STYLE</b>	
R		<b>UNDERSLUNG STYLE</b>	
R		<b>HENDRICKSON TRUCK SUSPENSION SYSTEMS HN - SERIES</b>	
F		<b>INTERNATIONAL SERIES 3000 - SCHOOL BUS CHASSIS</b>	
R		<b>SERIES 5000, 5000I - SEVERE SERVICE CONV TRK &amp; TRAC</b>	
R		<b>SERIES 8000 - CONVENTIONAL HEAVY DUTY TRACTOR</b>	
R		<b>SERIES 9100, 9100I - TRACTOR &amp; STRAIGHT TRUCK</b>	
R		<b>SERIES 9200, 9200I - TRACTOR &amp; STRAIGHT TRUCK</b>	
F		<b>SERIES 9300, 9300I, 9400 &amp; 9400I LONG HOOD CONV.</b>	
R		<b>SERIES 9300, 9300I, 9400 &amp; 9400I LONG HOOD CONV.</b>	
F		<b>SERIES 9600 &amp; 9700 PREMIUM CABOVER TRACTOR</b>	
R		<b>SERIES 9800 - PREMIUM CABOVER TRACTOR</b>	
F		<b>SERIES 9900, 9900I, 9900IX LONG HOOD CONV. TRUCK</b>	
R		<b>SERIES 9900, 9900I, 9900IX LONG HOOD CONV. TRUCK</b>	
F		<b>PACIFIC TRUCK &amp; TRAILER VARIOUS</b>	
R		<b>REYCO SUSPENSION DRIVE AXLE</b>	
R		<b>SAF HOLLAND TRUCK, BUS &amp; MOTORHOME AIR SUSPENSIONS</b>	
R	00-21	<b>TRUCK, BUS &amp; MOTORHOME AIR SUSPENSIONS</b>	
R	97-00	<b>SPARTAN MOTORS HIGHLANDER</b> All With I Beam Front Suspension	
R	91-96	<b>K2</b>	
R	97-00	<b>K2</b> All With I Beam Front Suspension	
R	97-00	<b>K2</b> All With Independent Front Granning Suspension	
R	97-00	<b>MOUNTAIN MASTER</b> All With Independent Front Granning Suspension	
R	95-00	<b>MOUNTAIN MASTER</b> All With I Beam Front Suspension	
F	99-10	<b>STERLING TRUCK A9500</b> All All with 13200 lb or 14600 lb Axle and 54" Taperleaf Spring	
F	99-01	<b>A9513</b> All All with 13200 lb or 14600 lb Axle and 54" Taperleaf Spring	
F	99	<b>A9522</b> All All with 13200 lb or 14600 lb Axle and 54" Taperleaf Spring	
F	99-10	<b>L8500</b> All All with 13200 lb or 14600 lb Axle and 54" Taperleaf Spring	
F	99	<b>L8501</b> All All with 13200 lb or 14600 lb Axle and 54" Taperleaf Spring	
F	99-01	<b>L8513</b> All All with 13200 lb or 14600 lb Axle and 54" Taperleaf Spring	
F	99-10	<b>L9500</b> All All with 13200 lb or 14600 lb Axle and 54" Taperleaf Spring	
F	99-00	<b>L9501</b> All All with 13200 lb or 14600 lb Axle and 54" Taperleaf Spring	

## Numerical listing

Shock	POP	Alternative No.	MTG Acc. Supplied
Pos.	Year	Application	
85030	C (cont)		
F	99-01	<b>L9511</b> All All with 13200 lb or 14600 lb Axle and 54" Taperleaf Spring	
F	99-00	<b>L9513</b> All All with 13200 lb or 14600 lb Axle and 54" Taperleaf Spring	
F	99	<b>L9522</b> All All with 13200 lb or 14600 lb Axle and 54" Taperleaf Spring	
R		<b>TUTHILL TECHNOLOGIIES DRIVE AXLE</b>	
R		<b>WABASH NATIONAL VARIOUS</b>	
85031	D	145147(1)/TR0027(2)	
F	93-05	<b>KENWORTH K300</b> All Models with 12,000 lb Taper Leaf Front Springs (5/8" Top Mounting bolt)	
F	01-08	<b>T300</b> All Models with 12,000 lb Taper Leaf Front Springs (5/8" Top Mounting bolt)	
F	99	<b>T300</b> All Models with 12,000 lb Taper Leaf Front Springs (5/8" Top Mounting bolt)	
F	08-10	<b>T370</b> All Models with 12,000 lb Front Axle	
85033	C	145099 (1)	
R		<b>INTERNATIONAL VARIOUS</b>	
R	95-02	<b>PETERBILT 330</b> All Models with Peterbilt 40000 lb Low Air Leaf Suspension	
R	87-01	<b>357</b> All Models with Peterbilt Low Air Leaf Suspension	
R	81-01	<b>362</b> All Models with Peterbilt Low Air Leaf Suspension	
R	89-93	<b>372</b> All Models with Peterbilt Low Air Leaf Suspension	
R	87-96	<b>375</b> All Models with Peterbilt Low Air Leaf Suspension	
R	99	<b>376</b> All Models with Peterbilt Low Air Leaf Suspension	
R	94-96	<b>376</b> All Models with Peterbilt Low Air Leaf Suspension	
R	88-92	<b>376</b> All Models with Peterbilt Low Air Leaf Suspension	
R	87-01	<b>377</b> All Models with Peterbilt Low Air Leaf Suspension	
R	88-02	<b>378</b> All Models with Peterbilt Low Air Leaf Suspension	
R	86-02	<b>379</b> All Models with Peterbilt Low Air Leaf Suspension	
R	95-02	<b>385</b> All Models with Peterbilt Low Air Leaf Suspension	
R	00-02	<b>387</b> All Models with Peterbilt Low Air Leaf Suspension	
85036	D		
R		<b>AUTOCAR LLC. ADDITIONAL APPLICATIONS</b>	
R	16-24	<b>XPERT</b> All Models with Hendrickson HTS 210 Suspension	
R		<b>BLUE BIRD ALL AMERICAN SERIES (FE &amp; RE MODELS)</b>	
R		<b>HENDRICKSON TRUCK SUSPENSION SYSTEMS</b>	
R		<b>ADDITIONAL APPLICATIONS</b>	
R	16-23	<b>LION LIONC</b> All Models with Hendrickson HTS 210 Suspension	
F	01-08	<b>MACK CV</b> All CV-713 Models with 18,000 lb Front Axles	
R	15-24	<b>GRANITE</b> All Models with Hendrickson HAS Series Rear Suspension	
R	08-19	<b>GU7</b> All GU713 Models with Hendrickson HAS Series Rear Suspension	
R	08-19	<b>GU8</b> All GU813 Models with Hendrickson HAS Series Rear Suspension	
F	81-07	<b>MR</b> All Models with Front Taperleaf Springs	
F	81-91	<b>R</b> All Models with Front Taperleaf Springs	
F	81-91	<b>R</b> All R, U, RD 600 Models/ MR600 Models with Front Taperleaf Springs	
F	81-91	<b>R</b> All R600 Models-3 1/2" Wide springs	
F	07	<b>RD</b> All Models with Front Taperleaf Springs	
F	07	<b>RD</b> All RD600 Models-3 1/2" Wide springs	
F	81-04	<b>RD</b> All Models with Front Taperleaf Springs	
F	81-04	<b>RD</b> All RD600 Models-3 1/2" Wide springs	

# Numerical listing

Shock	POP	Alternative No.	MTG Acc. Supplied
Pos.	Year	Application	
<b>85036</b>	D	(cont)	
R	10-17	TD700	All Titan TD713 Models with Hendrickson HAS Series Rear Suspension
R	08-17	TITAN	All Models with Hendrickson HAS Series Rear Suspension
F	81-89	U	All Models with Front Taperleaf Springs
F	86-08	<b>PETERBILT 357</b>	All Conventional Models with Front Air Suspension and without Set Back Front Axle.
F	86-06	362	All C.O.E. Models with 14600 lb Taper Leaf Springs and Set Back Front Axle
F	87-96	375	All Conventional Models with Front Air Suspension and without Set Back Front Axle.
F	99	376	All Conventional Models with Front Air Suspension and without Set Back Front Axle.
F	94-96	376	All Conventional Models with Front Air Suspension and without Set Back Front Axle.
F	88-92	376	All Conventional Models with Front Air Suspension and without Set Back Front Axle.
F	87-01	377	All Conventional Models with Front Air Suspension and without Set Back Front Axle.
F	88-07	378	All Conventional Models with Front Air Suspension and without Set Back Front Axle.
F	86-07	379	All Conventional Models with Front Air Suspension and without Set Back Front Axle.
F	06-16	386	All Conventional Models with Front Air Suspension and without Set Back Front Axle.
F	00-11	387	All Conventional Models with Front Air Suspension and without Set Back Front Axle.
F	08-15	388	All Conventional Models with Front Air Suspension and without Set Back Front Axle.
F	08-21	389	All Conventional Models with Front Air Suspension and without Set Back Front Axle.
R			<b>SPARTAN MOTORS</b> VARIOUS
R	06		<b>VOLVO VHD</b> All Models with Hendrickson HAS Series Rear Suspension
R			<b>XOS</b> ADDITIONAL O.E.M. INTERCHANGES
<b>85040</b>	W	<b>401754 (4)</b>	
F	90-91	<b>FORD</b> CL9000	All Models with Multileaf Spring
F	90-91	CLT9000	All Models with Multileaf Spring
F		<b>VOLVO FE</b> SERIES	
<b>85043</b>	W		
F		<b>FREIGHTLINER</b>	BUS CHASSIS
F	05-07	FC70	
F	99-04	FC70	All Models with 6000 to 9000 lb Front axle
F	99-07	FC80	All Models with 6000 to 9000 lb Front axle
F	91-06	FL70	All Models with 6000 to 9000 lb Front axle
F	91-06	FL80	All Models with 6000 to 9000 lb Front axle
F	00-02	XCS	CHASSIS
R		<b>HENDRICKSON TRAILER</b>	<b>SUSPENSION SYSTEMS</b>
R			UNDERSLUNG STYLE
R		<b>HENDRICKSON TRUCK</b>	<b>SUSPENSION SYSTEMS</b> VARIOUS
<b>85045</b>	A		
R		<b>CUSH CORPORATION</b>	TRAILER SUSPENSIONS - TOP MOUNT
R		<b>HENDRICKSON TRAILER</b>	<b>SUSPENSION SYSTEMS</b> CONNEX
R			INTRAAAX
R			UNDERSLUNG STYLE
R		<b>INGERSOLL AXLES</b>	VARIOUS
R		<b>REYCO</b>	SUSPENSION TRAILER
R		<b>RIDEWELL CORP.</b>	TRAILER AIR-RIDES
R		<b>SAF HOLLAND</b>	TRAILER AIR SUSPENSION
R		<b>TUTHILL TECHNOLOGIIES</b>	TRAILER

# 85000 Series

Shock	POP	Alternative No.	MTG Acc. Supplied
Pos.	Year	Application	
<b>85045</b>	A	(cont)	
R		<b>UTILITY TRAILER</b>	<b>MANUFACTURING COMPANY</b>
R		<b>FLATBEDS</b>	
R		<b>WABASH NATIONAL</b>	VARIOUS
R		<b>WATSON &amp; CHALIN MFG. INC.</b>	VARIOUS
<b>85046</b>	W	<b>140149 (1)</b>	
R		<b>AUTOCAR LLC.</b>	ADDITIONAL APPLICATIONS
R	93-95	<b>VOLVO WCA &amp; WIA</b> SERIES	
R	93-95	<b>WG</b> SERIES	
R	93-95	<b>WH</b> SERIES	
<b>85047</b>	D	<b>140149 (1)</b>	
F	96-98	<b>FORD</b> A9513	All Models with 12000 or 13200 lb Axle and 54" Multileaf Spring
F	97	A9522	All Models with 12000 or 13200 lb Axle and 54" Multileaf Spring
F	96-98	AT9513	All Models with 12000 or 13200 lb Axle and 54" Multileaf Spring
F	97-98	AT9522	All Models with 12000 or 13200 lb Axle and 54" Multileaf Spring
F		<b>LOUISVILLE SERIES -</b>	<b>CONVENTIONAL CAB</b>
F	99-10	<b>STERLING TRUCK</b> A9500	All Models with 12000 or 13200 lb Axle and 54" Multileaf Spring
F	99-01	A9513	All Models with 12000 or 13200 lb Axle and 54" Multileaf Spring
F	99	A9522	All Models with 12000 or 13200 lb Axle and 54" Multileaf Spring
F	99-10	L8500	All Models with 12000 or 13200 lb Axle and 54" Multileaf Spring
F	99	L8501	All Models with 12000 or 13200 lb Axle and 54" Multileaf Spring
F	99-00	L8511	All Models with 12000 or 13200 lb Axle and 54" Multileaf Spring
F	99-01	L8513	All Models with 12000 or 13200 lb Axle and 54" Multileaf Spring
F	99-10	L9500	All Models with 12000 or 13200 lb Axle and 54" Multileaf Spring
F	99-00	L9501	All Models with 12000 or 13200 lb Axle and 54" Multileaf Spring
F	99-00	L9511	All Models with 12000 or 13200 lb Axle and 54" Multileaf Spring
F	99-00	L9513	All Models with 12000 or 13200 lb Axle and 54" Multileaf Spring
F	99	L9522	All Models with 12000 or 13200 lb Axle and 54" Multileaf Spring
R		<b>VOLVO VN</b> SERIES - 2200	
R	96-98	<b>WCA &amp; WIA</b> SERIES	
R	96-97	<b>WH</b> SERIES	
<b>85051</b>	W		
R		<b>BLUE BIRD</b>	ADDITIONAL APPLICATIONS
R		<b>GILLIG</b>	VARIOUS
R		<b>OSHKOSH MOTOR TRUCK CO.</b>	VARIOUS
R		<b>REYCO</b>	SUSPENSION TRAILER
R		<b>SAF HOLLAND</b>	TRAILER AIR SUSPENSION
R			TRUCK, BUS & MOTORHOME AIR SUSPENSIONS
R			TRUCK & TRACTOR AIR SUSPENSION (TAG AXLE)
R		<b>STOUGHTON TRAILERS INC.</b>	VARIOUS
R		<b>TRAILMOBILE CANADA CORP.</b>	VARIOUS
R		<b>TUTHILL TECHNOLOGIIES</b>	TRAILER
R		<b>WABASH NATIONAL</b>	VARIOUS
<b>85052</b>	B		
R		<b>BLUE BIRD</b>	ADDITIONAL APPLICATIONS
R		<b>GREAT DANE</b>	TRAILER VARIOUS

# Numerical listing

Shock	POP	Alternative No.	MTG Acc. Supplied
Pos.	Year	Application	
<b>85052</b>	B	(cont)	
R		<b>HENDRICKSON TRAILER</b>	<b>SUSPENSION SYSTEMS</b>
R			ADDITIONAL APPLICATIONS
R		<b>CONNEX</b>	UNDERSLUNG STYLE
R		<b>INGERSOLL AXLES</b>	VARIOUS
R		<b>REYCO</b>	SUSPENSION TRAILER
R		<b>SAF HOLLAND</b>	TRUCK & TRACTOR AIR SUSPENSION (TAG AXLE)
R		<b>TUTHILL TECHNOLOGIIES</b>	TRAILER
R		<b>WABASH NATIONAL</b>	VARIOUS
R		<b>WATSON &amp; CHALIN MFG. INC.</b>	VARIOUS
R		<b>WCWB</b> SERIES	TRAILER AIR SUSPENSION
<b>85053</b>	C	<b>145126 (2)</b>	
F	98	<b>WESTERN STAR</b>	3800
F	99-01	3800	All Models with Multi-Leaf Front Springs
F	89-97	3800	All Models with Multi-Leaf Front Springs
F	89-02	4800	All Models with Multi-Leaf Front Springs
F	89-02	4900	All Models with Multi-Leaf Front Springs
F	97-02	5800	All Models with Multi-Leaf Front Springs
F	89-01	5900	All Models with Multi-Leaf Front Springs
F	89-01	6900	All Models with Multi-Leaf Front Springs
<b>85054</b>	W	<b>145080 (2)</b>	
F	96-98	<b>FORD</b> A9513	All All Models with 10000 lb or 12000 lb Axle and 54" Taperleaf Spring
F	96-98	A9513	All Models with 8500 or 9000 lb Axle and 54" Taperleaf Spring
F	97	A9522	All All Models with 10000 lb or 12000 lb Axle and 54" Taperleaf Spring
F	97	A9522	All Models with 8500 or 9000 lb Axle and 54" Taperleaf Spring
F	96	<b>AEROMAX (A, AT, AAT, 8500, 9500)</b> SERIES	
F	96-98	AT9513	All All Models with 10000 lb or 12000 lb Axle and 54" Taperleaf Spring
F	96-98	AT9513	All Models with 8500 or 9000 lb Axle and 54" Taperleaf Spring
F	97-98	AT9522	All All Models with 10000 lb or 12000 lb Axle and 54" Taperleaf Spring
F	97-98	AT9522	All Models with 8500 or 9000 lb Axle and 54" Taperleaf Spring
F	96-97	CF7000	All Models with 16000 lb. Multileaf Spring
F	96-97	CF8000	All Models with 16000 lb. Multileaf Spring
F	96-97	CFT8000	All Models with 16000 lb. Multileaf Spring
F	96	LA8000F	All Models with 16000 lb. Multileaf Spring
F	96-97	<b>LOUISVILLE SERIES -</b>	<b>CONVENTIONAL CAB</b>
F	99-10	<b>STERLING TRUCK</b> A9500	All Models with 10000 lb or 12000 lb Axle and 54" Taperleaf Spring
F	99-10	A9500	All Models with 8500 or 9000 lb Axle and 54" Taperleaf Spring
F	99-01	A9513	All Models with 10000 lb or 12000 lb Axle and 54" Taperleaf Spring
F	99-01	A9513	All Models with 8500 or 9000 lb Axle and 54" Taperleaf Spring
F	99	A9522	All Models with 10000 lb or 12000 lb Axle and 54" Taperleaf Spring
F	99	A9522	All Models with 8500 or 9000 lb Axle and 54" Taperleaf Spring
F	99-01	AT9513	All Models with 10000 lb or 12000 lb Axle and 54" Taperleaf Spring
F	99-01	AT9513	All Models with 8500 or 9000 lb Axle and 54" Taperleaf Spring
F	99-00	AT9522	All Models with 10000 lb or 12000 lb Axle and 54" Taperleaf Spring

# Numerical listing

Shock	POP	Alternative No.	MTG Acc. Supplied
Pos.	Year	Application	
<b>85054</b>	W	(cont)	<b>145080 (2)</b>
F	99-00	AT9522	All Models with 8500 or 9000 lb Axle and 54" Taperleaf Spring
F	98	CARGO LINE	
F		L - LINE 8500 SERIES - CONVENTIONAL CAB	
F	98	L - LINE 8500 SERIES - CONVENTIONAL CAB	
F	98-09	L - LINE 9500 SERIES - CONVENTIONAL CAB	
<b>85055</b>	W		<b>145080 (2)</b>
F	96-98	FORD A9513	All All with 12000 lb, 13000 lb or 14600 lb Axle and 60" Taperleaf Spring
F	97	A9522	All All with 12000 lb, 13000 lb or 14600 lb Axle and 60" Taperleaf Spring
F	96-98	AT9513	All All with 12000 lb, 13000 lb or 14600 lb Axle and 60" Taperleaf Spring
F	97-98	AT9522	All All with 12000 lb, 13000 lb or 14600 lb Axle and 60" Taperleaf Spring
F	96-98	LOUISVILLE SERIES - CONVENTIONAL CAB	
F	99-10	STERLING TRUCK A9500	All All Models with 12000 lb, 13200 lb or 14600 lb Axle and 60" Taperleaf Spring
F	99-10	A9500	All Models with 14600 lb or 16000 lb Axle and 54"Multi-leaf Spring
F	99-01	A9513	All All Models with 12000 lb, 13200 lb or 14600 lb Axle and 60" Taperleaf Spring
F	99-01	A9513	All Models with 14600 lb or 16000 lb Axle and 54"Multi-leaf Spring
F	99	A9522	All All Models with 12000 lb, 13200 lb or 14600 lb Axle and 60" Taperleaf Spring
F	99	A9522	All Models with 14600 lb or 16000 lb Axle and 54"Multi-leaf Spring
F	99-10	L8500	All Models with 12000 lb, 13200 lb or 14600 lb Axle and 60" Taperleaf Spring
F	99-10	L8500	All Models with 14600 lb or 16000 lb Axle and 54"Multi-leaf Spring
F	99	L8501	All Models with 12000 lb, 13200 lb or 14600 lb Axle and 60" Taperleaf Spring
F	99	L8501	All Models with 14600 lb or 16000 lb Axle and 54"Multi-leaf Spring
F	99-00	L8511	All Models with 12000 lb, 13200 lb or 14600 lb Axle and 60" Taperleaf Spring
F	99-00	L8511	All Models with 14600 lb or 16000 lb Axle and 54"Multi-leaf Spring
F	99-01	L8513	All Models with 12000 lb, 13200 lb or 14600 lb Axle and 60" Taperleaf Spring
F	99-01	L8513	All Models with 14600 lb or 16000 lb Axle and 54"Multi-leaf Spring
F	99-10	L9500	All Models with 12000 lb, 13200 lb or 14600 lb Axle and 60" Taperleaf Spring
F	99-10	L9500	All Models with 14600 lb or 16000 lb Axle and 54"Multi-leaf Spring
F	99-00	L9501	All Models with 12000 lb, 13200 lb or 14600 lb Axle and 60" Taperleaf Spring
F	99-00	L9501	All Models with 14600 lb or 16000 lb Axle and 54"Multi-leaf Spring
F	99-00	L9511	All Models with 12000 lb, 13200 lb or 14600 lb Axle and 60" Taperleaf Spring
F	99-00	L9511	All Models with 14600 lb or 16000 lb Axle and 54"Multi-leaf Spring
F	99-00	L9513	All Models with 12000 lb, 13200 lb or 14600 lb Axle and 60" Taperleaf Spring
F	99-00	L9513	All Models with 14600 lb or 16000 lb Axle and 54"Multi-leaf Spring

# 85000 Series

Shock	POP	Alternative No.	MTG Acc. Supplied
Pos.	Year	Application	
<b>85055</b>	W	(cont)	<b>145080 (2)</b>
F	99	L9522	All Models with 12000 lb, 13200 lb or 14600 lb Axle and 60" Taperleaf Spring
F	99	L9522	All Models with 14600 lb or 16000 lb Axle and 54"Multi-leaf Spring
<b>85058</b>	C		
F		BLUE BIRD ALL AMERICAN SERIES (FE & RE MODELS)	
F		FREIGHTLINER MB CHASSIS	
F		MT55	
F		VARIOUS	
F	99-14	INTERNATIONAL 5600I	All Models with 16,000 lb to 20,000 lb Front axle
F	00-12	5900I	All Models with 16,000 lb to 20,000 lb Front axle
F	18-24	HX520	All Models with 12,000 lb to 14,000 lb Parabolic Taperleaf Front Suspension
F		PAYSTAR	
F		SERIES 2000 - CONVENTIONAL TRUCK (SEVERE SERVICE)	
F		SERIES 4000 - SHORT CONVENTIONAL MEDIUM TRK & TRAC	
F		SERIES 8000 - CONVENTIONAL HEAVY DUTY TRACTOR	
F		SERIES 9300, 9300I, 9400 & 9400I LONG HOOD CONV.	
F		SERIES 9600 & 9700 PREMIUM CABOVER TRACTOR	
F		SERIES 9900, 9900I, 9900IX LONG HOOD CONV. TRUCK	
F		WORKSTAR - 7000 SERIES	
F		OSHKOSH MOTOR TRUCK CO. VARIOUS	
F		PIERCE MFG. INC. VARIOUS	
R	93-00	SAFARI MOTOR COACH CLASS A MOTORHOMES	
F		THOMAS VARIOUS	
<b>85059</b>	W		
R		RED LION TRAILER VARIOUS	
R		SAF HOLLAND TRAILER AIR SUSPENSION	
R		STOUGHTON TRAILERS INC. VARIOUS	
R		TRAILMOBILE CANADA CORP. VARIOUS	
R		WABASH NATIONAL VARIOUS	
<b>85060</b>	W		
R	08-20	AUTOCAR LLC. XPEDITOR	All 8 X 4 Models with Chalmers 800 Series - 46K Tandem Truck Suspensions ( HD Shock Kit with High Mounts)
R		CHALMERS SUSPENSION	VARIOUS
R	01-07	FREIGHTLINER CONDOR	All Models with Chalmers 46,000 lb Rear Suspension
R	01-20	CORONADO	All Models with Chalmers 46,000 lb Rear Suspension
R	12-21	INTERNATIONAL	VARIOUS
R	10-18	KENWORTH T440	
R	10-18	T470	
R	87-21	T800	All Models with Chalmers 40,000 lb Rear Suspension
R	00-09	T800B, T800B(8X4), T800SH, T800H, T800W	
R	87-08	PETERBILT 357	All Models with Chalmers 40,000 lb Rear Suspension
R	81-06	362	All Models with Chalmers 40,000 lb Rear Suspension
R	08-19	365	All Models with Chalmers 40,000 lb Rear Suspension
R	08-19	367	All Models with Chalmers 40,000 lb Rear Suspension
R	89-93	372	All Models with Chalmers 40,000 lb Rear Suspension
R	87-96	375	All Models with Chalmers 40,000 lb Rear Suspension
R	99	376	All Models with Chalmers 40,000 lb Rear Suspension
R	94-96	376	All Models with Chalmers 40,000 lb Rear Suspension
R	88-92	376	All Models with Chalmers 40,000 lb Rear Suspension
R	87-01	377	All Models with Chalmers 40,000 lb Rear Suspension

# Numerical listing

Shock	POP	Alternative No.	MTG Acc. Supplied
Pos.	Year	Application	
<b>85060</b>	W	(cont)	
R	88-07	378	All Models with Chalmers 40,000 lb Rear Suspension
R	86-07	379	All Models with Chalmers 40,000 lb Rear Suspension
R		385	
R	14-19	567	All Models with Chalmers 40,000 lb Rear Suspension
R		SAF HOLLAND TRAILER AIR SUSPENSION	
R		TRUCK, BUS & MOTORHOME AIR SUSPENSIONS	
R		WATSON & CHALIN MFG. INC. VARIOUS	
R		WESTERN STAR 5900 & 6900 SERIES - HERITAGE CLASS	
<b>85061</b>	A		
F	21-24	MACK ANTHEM	All Anthem 64T Models with 12,000 to 12,500 lb Front Axles
F	18-24	ANTHEM	All Models with 13,200 to 14,600 lb Front Axles
F	04-07	CHN	All CHN-613 Models with 12,000 lb Front Axle
R	07	CHU	
R	98-05	CX	All CX Vision Models w/ Hendrickson Air Suspension
R	98-05	CX	All CX Vision Models w/ Parabolic Spring
F	98-05	CX	All Models with O.E.M. Number
F	05-08	CXN	All CXN-613 Models with 12,000 lb Front Axles
R	08	CXN	All CXN-613 Models with 40,000 lb Rear Air Suspensions
F	06-07	CXP	All CXP-613 Models with 12,000 lb Front Axles
R	06-07	CXP	All CXP-613 Models with 40,000 lb Rear Air Suspensions
F	08-19	CXU	All Models with 12,000 - 14,600 lb Front Axles
F	06-10	POWERHOUSE COACH INC. VARIOUS	
F	06-10	RENEGADE	VARIOUS
F	14	VOLVO VAH SERIES	
F	00-24	VNL	All Models with 12,000 - 13,200 lb Front Axles
F	06-24	VNL 300	
F	16-20	VNL 300	All Models with 12,000 - 13,200 lb Front Axles
F	06-10	VNL 430	
F	15-16	VNL 430	All Models with 12,500 - 14,600 lb Front Axle
F	06-10	VNL 630	
F	15-16	VNL 630	All Models with 12,500 - 14,600 lb Front Axle
F	06-10	VNL 670	
F	15-16	VNL 670	All Models with 12,500 - 14,600 lb Front Axle
F	17-24	VNL 740	
F	17-20	VNL 740	All Models with 12,500 - 14,600 lb Front Axle
F	21-24	VNL 760	
F	17-20	VNL 760	All Models with 12,500 - 14,600 lb Front Axle
F	20	VNL 760	All Models with 13,200 lb to 14,600 lb Front Axle
F	21-24	VNL 860	
F	17-20	VNL 860	All Models with 12,500 - 14,600 lb Front Axle
F	06-24	VNL SERIES	
F	11-18	VNM	All Models with 12,000 - 14,600 lb Front Axle
F	21-24	VNR	All Models with 12,000 lb to 12,500 lb Front Axle
F	21-24	VNR	All Models with 13,200 lb to 14,600 lb Front Axle
F	18-19	VNR	All Models with 12,500 lb Front Axle
F	17-24	VNR 300	
F	17-24	VNR 400	
F	17-24	VNR 640	
F		VN SERIES - 2200	
F	19-20	VNX	All Models with 12,500 - 14,600 lb Front Axle
F	14-17	VNX	All Models with 12,500 - 14,600 lb Front Axle
F	06-10	VT	All All Models with 12,000 - 13,200 lb Front Axles
<b>85062</b>	A		<b>145080 (2)</b>
F	23	KENWORTH T880	All Models with 18,000 lb to 23,000 lb Taperleaf Front Spring Suspension and Set Forward Front Axle.



# Numerical listing

Shock	POP	Alternative No.	MTG Acc. Supplied
Pos.	Year	Application	
<b>85062</b>		A (cont)	<b>145080 (2)</b>
F	18-20	W900 All Models with 18,000 lb to 23,000 lb Taperleaf Front Spring Suspension and Set Forward Front Axle.	
F		W900, W900B, W900L, W900S	
F	23	W990 All Models with 18,000 lb to 23,000 lb Taperleaf Front Spring Suspension and Set Forward Front Axle.	
F	01-18	<b>PETERBILT 320</b> All Models with 18,000 lb to 23,000 lb Taperleaf Front Spring Suspension and Set Forward Front Axle.	
F	87-18	320 All Models with 12,000 lb to 14,600 lb Taperleaf Spring Suspension and Set Forward Front Axle.	
F	87-08	357 All Models with 12,000 lb to 14,600 lb Taperleaf Spring Suspension and Set Forward Front Axle.	
F	87-08	357 All Models with 18,000 lb to 23,000 lb Taperleaf Front Spring Suspension and Set Forward Front Axle.	
F	08-22	365 All Models with 18,000 lb to 23,000 lb Taperleaf Front Spring Suspension and Set Forward Front Axle.	
F	08-20	365 All Models with 12,000 lb to 14,600 lb Taperleaf Spring Suspension and Set Forward Front Axle.	
F	08-24	367 All Models with 18,000 lb to 23,000 lb Taperleaf Front Spring Suspension and Set Forward Front Axle.	
F	14-20	367 All Models with 12,000 lb to 14,600 lb Taperleaf Spring Suspension and Set Forward Front Axle.	
F	87-96	375 All Models with 12,000 lb to 14,600 lb Taperleaf Spring Suspension and Set Forward Front Axle.	
F	87-96	375 All Models with 18,000 lb to 23,000 lb Taperleaf Front Spring Suspension and Set Forward Front Axle.	
F	02	376	
F	00	376	
F	99	376 All Models with 12,000 lb to 14,600 lb Taperleaf Spring Suspension and Set Forward Front Axle.	
F	99	376 All Models with 18,000 lb to 23,000 lb Taperleaf Front Spring Suspension and Set Forward Front Axle.	
F	95-96	376 All Models with 12,000 lb to 14,600 lb Taperleaf Spring Suspension and Set Forward Front Axle.	
F	95-96	376 All Models with 18,000 lb to 23,000 lb Taperleaf Front Spring Suspension and Set Forward Front Axle.	
F	92	376 All Models with 12,000 lb to 14,600 lb Taperleaf Spring Suspension and Set Forward Front Axle.	
F	92	376 All Models with 18,000 lb to 23,000 lb Taperleaf Front Spring Suspension and Set Forward Front Axle.	
F	88-90	376 All Models with 12,000 lb to 14,600 lb Taperleaf Spring Suspension and Set Forward Front Axle.	
F	88-90	376 All Models with 18,000 lb to 23,000 lb Taperleaf Front Spring Suspension and Set Forward Front Axle.	
F	87-01	377 All Models with 12,000 lb to 14,600 lb Taperleaf Spring Suspension and Set Forward Front Axle.	
F	87-01	377 All Models with 18,000 lb to 23,000 lb Taperleaf Front Spring Suspension and Set Forward Front Axle.	

# 85000 Series

Shock	POP	Alternative No.	MTG Acc. Supplied
Pos.	Year	Application	
<b>85062</b>		A (cont)	<b>145080 (2)</b>
F	88-07	378 All Models with 12,000 lb to 14,600 lb Taperleaf Spring Suspension and Set Forward Front Axle.	
F	88-07	378 All Models with 18,000 lb to 23,000 lb Taperleaf Front Spring Suspension and Set Forward Front Axle.	
F	86-07	379 All Models with 12,000 lb to 14,600 lb Taperleaf Spring Suspension and Set Forward Front Axle.	
F	86-07	379 All Models with 18,000 lb to 23,000 lb Taperleaf Front Spring Suspension and Set Forward Front Axle.	
F	11-17	382 All Models with 12,000 lb to 14,600 lb Taperleaf Spring Suspension and Set Forward Front Axle.	
F	08-16	384 All Models with 12,000 lb to 14,600 lb Taperleaf Spring Suspension and Set Forward Front Axle. (Heavy Duty)	
F		385	
F	06-16	386 All Models with 12,000 lb to 14,600 lb Taperleaf Spring Suspension and Set Forward Front Axle.	
F	06-16	386 All Models with 18,000 lb to 23,000 lb Taperleaf Front Spring Suspension and Set Forward Front Axle.	
F		387	
F	13-15	388 All Models with 12,000 lb to 14,600 lb Taperleaf Spring Suspension and Set Forward Front Axle. (Heavy Duty)	
F	08-15	388 All Models with 12,000 lb to 14,600 lb Taperleaf Spring Suspension and Set Forward Front Axle.	
F	08-15	388 All Models with 18,000 lb to 23,000 lb Taperleaf Front Spring Suspension and Set Forward Front Axle.	
F	08-24	389 All Models with 12,000 lb to 14,600 lb Taperleaf Spring Suspension and Set Forward Front Axle.	
F	08-23	389 All Models with 18,000 lb to 23,000 lb Taperleaf Front Spring Suspension and Set Forward Front Axle.	
F	17-24	520 All Models with 18,000 lb to 23,000 lb Taperleaf Front Spring Suspension and Set Forward Front Axle.	
F	14-24	567 All Models with 12,000 lb to 14,600 lb Taperleaf Spring Suspension and Set Forward Front Axle.	
F	14-23	567 All Models with 18,000 lb to 23,000 lb Taperleaf Front Spring Suspension and Set Forward Front Axle.	
F	13-18	579 All Models with 12,000 lb to 14,600 lb Taperleaf Spring Suspension and Set Forward Front Axle.	
F	11-18	587 All Models with 12,000 lb to 14,600 lb Taperleaf Spring Suspension and Set Forward Front Axle.	
<b>85063</b>		W	<b>145080 (2)</b>
F	94-97	<b>FORD F-700</b> All Models with 52" or 54" Taperleaf Springs and with 10000 or 12000 lb Axle	
F	94-97	F-800 All Models with 52" or 54" Taperleaf Springs and with 10000 or 12000 lb Axle	
F	94-97	FT900 All Models with 52" or 54" Taperleaf Springs and with 10000 or 12000 lb Axle	
<b>85064</b>		C	
R		<b>CUSH CORPORATION TRAILER SUSPENSIONS - LOW MOUNT TRAILER SUSPENSIONS - TOP MOUNT</b>	
R		<b>GREAT DANE TRAILER VARIOUS</b>	

# Numerical listing

Shock	POP	Alternative No.	MTG Acc. Supplied
Pos.	Year	Application	
<b>85064</b>		C (cont)	
R		<b>HENDRICKSON TRAILER SUSPENSION SYSTEMS UNDERSLUNG STYLE</b>	
R		<b>WATSON &amp; CHALIN MFG. INC. VARIOUS</b>	
<b>85065</b>		W	<b>145128 (1)</b>
R	18-24	<b>MACK GRANITE</b> All Granite 64BR & 64FR Models with 46,000 lb Mack Mride Rear Suspension	
R	19-24	LR All Models with 46,000 lb Mack Mride Rear Suspension	
R	08-19	MRU All MRU613 Models with 46,000 lb Mack Mride Rear Suspension	
R	08-24	<b>VOLVO VHD</b> All Models with T-Ride Rear Suspension	
R		VNM SERIES	
R		VOCATIONAL TRUCKS	
<b>85066</b>		B	
R	04-07	<b>MACK CHN</b> All CHN-613 Models w/ MACK Air Suspension	
R	98-05	CX All CX Vison Models w/ MACK Air Suspension	
R	05-07	CXN All CXN-613 Models w/ MACK Air Suspension	
R	06-11	<b>POWERHOUSE COACH INC. VARIOUS</b>	
R	06-11	<b>RENEGADE VARIOUS</b>	
R	04	<b>VOLVO VN</b> All Models with O.E.M. Number	
R	99	VN All Models with O.E.M. Number	
R	00-11	VNL All Models with 38,000 lb Rear Air Suspension	
R	06-11	VNL 300	
R	05-11	VNL 430	
R	06-11	VNL 630	
R	06-11	VNL 670	
R	06-11	VNL SERIES	
R		VN SERIES - 2200	
R	00	VN SERIES - 2200	
R	06-10	VT All 64T-830 Models with 40,000 lb Rear Air Suspension	
<b>85067</b>		A	
R	01-16	<b>KENWORTH C500</b> All Models with Air Glide 380 (AG380) Rear Air Suspension	
R	16-17	ICON 900	
R	12-21	T440	
R	10-19	T470	
R	01-07	T600, T600B, T602	
R	01-08	T600A All Models with Air Glide 380 (AG380) Rear Air Suspension	
R	07-20	T660 All Models with Air Glide 380 (AG380) Rear Air Suspension	
R	11-24	T680 All Models with Air Glide 380 (AG380) Rear Air Suspension	
R	11-16	T700 All Models with Air Glide 380 (AG380) Rear Air Suspension	
R	01-23	T800 All Models with Air Glide 380 (AG380) Rear Air Suspension	
R	01-09	T800B, T800B(8X4), T800SH, T800H, T800W	
R	11-24	T880 All Models with Air Glide 380 (AG380) Rear Air Suspension	
R	01-11	T2000 All Models with Air Glide 380 (AG380) Rear Air Suspension	
R	01-21	W900 All Models with Air Glide 380 (AG380) Rear Air Suspension	
R	01-21	W900B, W900L, W900S	
R	19-24	W990 All Models with Air Glide 380 (AG380) Rear Air Suspension	
R	08-20	<b>PETERBILT 365</b> All Models with FlexAir Suspension (38000 lb)	
R	08-20	367 All Models with FlexAir Suspension (38000 lb)	
R	99-07	378 All Models with FlexAir Suspension (38000 lb)	
R	99-07	379 All Models with FlexAir Suspension (38000 lb)	
R	11-17	382 All Models with FlexAir Suspension (38000 lb)	
R	08-16	384 All Models with FlexAir Suspension (38000 lb)	
R	95-07	385 All Models with FlexAir Suspension (38000 lb)	
R	06-16	386 All Models with FlexAir Suspension (38000 lb)	
R	00-11	387 All Models with FlexAir Suspension (38000 lb)	
R	08-15	388 All Models with FlexAir Suspension (38000 lb)	

## Numerical listing

Shock	POP	Alternative No.	MTG Acc. Supplied
Pos.	Year	Application	
<b>85067</b>	A	(cont)	
R	08-24	389	All Models with FlexAir Suspension (38000 lb)
R	14-24	567	All Models with FlexAir Suspension (38000 lb)
R	13-24	579	All Models with FlexAir Suspension (38000 lb)
R	11-18	587	All Models with FlexAir Suspension (38000 lb)
<b>85069</b>	A	145089-000 (2)	
R	20-23	<b>KENWORTH</b> T370	All Models with Air Glide 400L (AG400L) Rear Air Suspension
R	08-23	T370	All Models with AG210L Rear Air Suspension
R	11-21	T440	
R	10-21	T470	
R	07-20	T660	All Models with Air Glide 400L (AG400L) Rear Air Suspension
R	13-24	T680	All Models with Air Glide 400L (AG400L) Rear Air Suspension
R	11-16	T700	All Models with Air Glide 400L (AG400L) Rear Air Suspension
R	08-23	T800	All Models with Air Glide 400L (AG400L) Rear Air Suspension
R	11-24	T880	All Models with Air Glide 400L (AG400L) Rear Air Suspension
R	08-24	W900	All Models with Air Glide 400L (AG400L) Rear Air Suspension
R	19-24	W990	All Models with Air Glide 400L (AG400L) Rear Air Suspension
R	02-18	<b>PETERBILT</b> 320	All Models with Peterbilt Low Air Leaf Suspension
R	07-22	330	All Models with Peterbilt Low Air Leaf Suspension
R	03-05	330	All Models with Peterbilt Low Air Leaf Suspension
R	05-10	335	All Models with Peterbilt Low Air Leaf Suspension
R	10-23	337	All Models with Peterbilt Low Air Leaf Suspension
R	02-08	357	All Models with Peterbilt Low Air Leaf Suspension
R	02-06	362	All Models with Peterbilt Low Air Leaf Suspension
R	08-23	365	All Models with Peterbilt Low Air Leaf Suspension
R	08-23	367	All Models with Peterbilt Low Air Leaf Suspension
R	03-07	378	All Models with Peterbilt Low Air Leaf Suspension
R	03-07	379	All Models with Peterbilt Low Air Leaf Suspension
R	11-17	382	All Models with Peterbilt Low Air Leaf Suspension
R	08-16	384	All Models with Peterbilt Low Air Leaf Suspension
R	04-07	385	All Models with Peterbilt Low Air Leaf Suspension
R	06-16	386	All Models with Peterbilt Low Air Leaf Suspension
R	03-11	387	All Models with Peterbilt Low Air Leaf Suspension
R	08-15	388	All Models with Peterbilt Low Air Leaf Suspension
R	08-24	389	All Models with Peterbilt Low Air Leaf Suspension
R	17-23	520	All Models with Peterbilt Low Air Leaf Suspension
R	22-24	537	All Models with Peterbilt Low Air Leaf Suspension
R	22-23	548	All Models with Peterbilt Low Air Leaf Suspension
R	14-24	567	All Models with Peterbilt Low Air Leaf Suspension
R	13-24	579	All Models with Peterbilt Low Air Leaf Suspension
R	11-18	587	All Models with Peterbilt Low Air Leaf Suspension
<b>85070</b>	A	401754 (2)	
F	12-22	<b>KENWORTH</b> T440	
F	10-21	T470	
F	05-07	T600, T600B, T602	
F	05-08	T600A	All Models with 13,000 lb Front Axle
F	07-20	T660	All Models with 12,000 or 13,200 lb Front Axle
F	11-16	T700	All Models with 13,000 lb Front Axle
F	05-23	T800	All Models with 12,000 to 20,000 lb Front Axles
F	06-11	T2000	All Models with 13,000 lb Front Axle

## 85000 Series

Shock	POP	Alternative No.	MTG Acc. Supplied
Pos.	Year	Application	
<b>85070</b>	A	(cont)	
F	05-22	W900	All Models with 12,000 or 13,200 lb Front Axle
<b>85071</b>	W	145054 (2)	
R	90-07	<b>CHEVROLET</b> B6	
R	93-02	B7	All With 15000, 19000, 21000 lb Multileaf Springs
R	90-96	C70 KODIAK	All Conventional Cab w/15000, 19000, 21000 lb Multileaf Springs
R	90-02	C4500 KODIAK	
R	92-02	C5500 KODIAK	
R	97-09	C6500 KODIAK	All Conventional Cab w/15000, 19000, 21000 lb Multileaf Springs
R	02-09	C7500 KODIAK	All Conventional Cab w/15000, 19000, 21000 lb Multileaf Springs
R	97-99	C7500 KODIAK	All Conventional Cab w/15000, 19000, 21000 lb Multileaf Springs
R	90-06	T5500	
R	03	T6500	
R	90-96	T6500	
R	03	T7500	
R	90-96	T7500	
R	04-06	T7500	All Tilt Cab w/15000, 19000, 21000 lb Multileaf Springs
R	97-02	T7500	All Tilt Cab w/15000, 19000, 21000 lb Multileaf Springs
R	90-03	T8500	
R	04-06	T8500	All Tilt Cab w/15000, 19000, 21000 lb Multileaf Springs
R	93-02	<b>GMC</b> B7	All School Bus Chassis w/15000, 19000, 21000 lb Multileaf Springs
R	90-02	C4500 TOPKICK	
R	90-02	C5500 TOPKICK	
R	90-09	C - SERIES (C6500, C7500, C8500)	TOPKICK
R	90-06	T5500	
R	03	T6500	
R	90-96	T6500	
R	03	T7500	
R	90-96	T7500	
R	04-06	T7500	All Tilt Cab with 15000, 19000, 21000 lb Multileaf Springs
R	97-02	T7500	All Tilt Cab with 15000, 19000, 21000 lb Multileaf Springs
R	98-06	T8500	
R	00-02	<b>ISUZU</b> FSR	All Models with 15000, 19000, 21000 lb Multileaf Springs
R	94-09	FVR	All Models with 15000, 19000, 21000 lb Multileaf Springs
R	90-92	FVR	All Models with 15000, 19000, 21000 lb Multileaf Springs
<b>85072</b>	C		
R	24	<b>AUTOCAR</b> LLC, DC-64	
R	20-23	DC-64	All Models with Hendrickson Primaax EX 462 Air Suspensions with 8 1/2" to 10" Ride Height
R	08-23	XPEDITOR	All 4 X 2 Models with Hendrickson Primaax EX 232 Air Suspensions with 8 1/2" to 10" Ride Height
R	08-23	XPEDITOR	All 6 X 4 Models with Hendrickson Primaax EX 462 Air Suspensions with 8 1/2" to 10" Ride Height
R	08-23	XPEDITOR	All 8 X 4 Models with Hendrickson Primaax EX 462 Air Suspensions with 8 1/2" to 10" Ride Height
R	13	XPERT	
R	14-23	XPERT	All 6 X 4 Models with Hendrickson Primaax EX 462 Air Suspensions with 8 1/2" to 10" Ride Height
R	12	XPERT	All 6 X 4 Models with Hendrickson Primaax EX 462 Air Suspensions with 8 1/2" to 10" Ride Height
R	11-17	<b>CATERPILLAR</b> CT660	All Models with Hendrickson Primaax EX 232, 462 and 692 Air Suspension (8-1/2" to 10" Ride Height)
R		<b>HENDRICKSON TRUCK SUSPENSION SYSTEMS</b>	<b>FIREMAAX - SERIES</b>
R		<b>PRIMAAX - SERIES</b>	
R	00-17	<b>INTERNATIONAL</b> 5900I	All Models with 46,000 lb Hendrickson Rear Air Suspension

## Numerical listing

Shock	POP	Alternative No.	MTG Acc. Supplied
Pos.	Year	Application	
<b>85072</b>	C	(cont)	
R	19-23	HV607	All Models with Hendrickson Primaax 230/460 Air Suspension with 9" Ride Height
R	19-23	HV613	All Models with Hendrickson Primaax 230/460 Air Suspension with 9" Ride Height
R	17-22	HX515	All Models with Hendrickson Primaax 230/460 Air Suspension with 9" Ride Height
R	18-23	HX520	All Models with Hendrickson Primaax 230/460 Air Suspension with 9" Ride Height
R	17-22	HX615	All Models with Hendrickson Primaax 230/460 Air Suspension with 9" Ride Height
R	17-24	HX620	All Models with Hendrickson Primaax 230/460 Air Suspension with 9" Ride Height
R		PAYSTAR - 5000 SERIES	
R	10-15	PAYSTAR - 5000 SERIES	
R		WORKSTAR - 7000 SERIES	
R	08-23	<b>KENWORTH</b> T370	All Models with Hendrickson Primaax 230, 232, 460, 462, 690 and 692 Air Suspension (8-1/2" to 10" Ride Height)
R	12-20	T440	
R	10-19	T470	
R	13-24	T680	All Models with Hendrickson Primaax EX 462 Air Suspensions with 8 1/2" to 10" Ride Height
R	04-24	T800	All Models with Hendrickson Primaax EX 232, 462 and 692 Air Suspension (8-1/2" to 10" Ride Height)
R	11-24	T880	All Models with Hendrickson Primaax EX 462 Air Suspensions with 8 1/2" to 10" Ride Height
R	04-24	W900	All Models with Hendrickson Primaax EX 462 Air Suspensions with 8 1/2" to 10" Ride Height
R	19-24	W990	All Models with Hendrickson Primaax 230, 460 and 690 Air Suspension (8-1/2" to 10" Ride Height)
R	06-16	<b>MACK</b> ADDITIONAL APPLICATIONS	
R	19-21	PINNACLE	All Models with Hendrickson 40,000 lb Pimaax EX and FireMaax EX Air Suspension
R	10-17	TD700	All TD-713 Models with Hendrickson 40,000 lb Pimaax EX and FireMaax EX Air Suspension
R	08-17	TITAN	All Models with Hendrickson 40,000 lb Pimaax EX and FireMaax EX Air Suspension
R		<b>MC NEILUS TRUCK &amp; MAN.</b>	<b>VARIOUS</b>
R	19-23	<b>PIERCE MFG. INC.</b>	<b>VARIOUS</b>
R	06-22	<b>VOLVO</b> VHD	All Models with Hendrickson 40,000 lb Pimaax EX and FireMaax EX Air Suspension
R	16-20	VNL 300	All Models with Hendrickson 40,000 lb Pimaax EX and FireMaax EX Air Suspension
R	06-16	VNL SERIES	
R	06-10	VT	All 64T-830 Models with Hendrickson 40,000 lb Primaax, Pimaax EX and FireMaax EX Air Suspension
R	06-10	VT	All 64T-880 Models with Hendrickson 40,000 lb Pimaax EX and FireMaax EX Air Suspension
R	12-22	<b>WESTERN STAR</b> 4700SB	All Models with Hendrickson Primaax EX 462 Air Suspensions with 8 1/2" to 10" Ride Height
R	12-22	4700SF	All Models with Hendrickson Primaax EX 462 Air Suspensions with 8 1/2" to 10" Ride Height
<b>85078</b>	W		
R		<b>DANA</b>	<b>VARIOUS</b>
R		<b>WABASH NATIONAL</b>	<b>VARIOUS</b>
<b>85079</b>	W		
R		<b>HENDRICKSON TRAILER SUSPENSION SYSTEMS</b>	<b>UNDERSLUNG STYLE</b>
R		<b>MC NEILUS TRUCK &amp; MAN.</b>	<b>VARIOUS</b>

## Numerical listing

Shock	POP	Alternative No.	MTG Acc. Supplied
Pos.	Year	Application	
85080	W	145054 (1)	
F	05-07	<b>MACK CT</b> All Models with 20,000 lb Front Axles	
F	08-10	GU7 All GU-713 Models with 20,000 lb Front Axles	
F	08-10	GU8 All GU-813 Models with 20,000 lb Front Axles	
85081	W	145090 (1)	
F	<b>VOLVO VAH SERIES</b>		
F	02-24	VHD All Models with 12,000 to 22,000 lb Front Axles	
85082	W		
R	16-17	<b>IC CORPORATION CE SCHOOL BUS</b> All CE Model School Buses with 20,000 lb Rear Air Suspension	
85084	C		
F	10-14	<b>KENWORTH T370</b> All Models with 10,000 lb to 12,000 lb Front Axle	
F	10-14	T370 All Models with 13,200 lb to 14,600 lb Front Axle	
F	10-14	T370 All Models with 8,000 lb Front Axle	
F	13-14	T680 All Models with 10,000 lb to 13,200 lb Front Axle	
F	10-14	<b>PETERBILT 337</b> All Models with 10,000 lb to 12,000 lb Front Axle	
F	10-14	337 All Models with 13,200 lb to 14,600 lb Front Axle	
F	12-13	348 All Models with 10,000 lb to 12,000 lb Front Axle	
F	11-17	382 All Models with 10,000 lb to 12,000 lb Front Axle	
F	13-16	579 All Day Cab Models with 10,000 lb to 12,000 lb Front Axle	
85086	W		
F	16-21	<b>AUTOCAR LLC. XPEDITOR</b> All Models with 20,000 lb Front Axle	
F	<b>BLUE BIRD ADDITIONAL APPLICATIONS</b>		
R	<b>REYCO SUSPENSION TRAILER</b>		
85087	W		
R	<b>HENDRICKSON TRUCK SUSPENSION SYSTEMS PRIMAAX - SERIES</b>		
R	<b>MC NEILUS TRUCK &amp; MAN. VARIOUS</b>		
85088	A		
R	18-20	<b>MACK ANTHEM</b> All Anthem 64T Models with 40,000 lb Rear Air Suspensions	
R	11-19	CHU All CHU-613 Models with 40,000 lb Rear Air Suspensions	
R	11-19	CXU All CXU613 Models with 40,000 lb Rear Air Suspensions	
R	11-22	<b>POWERHOUSE COACH INC. VARIOUS</b>	
R	11-18	<b>RENEGADE VARIOUS</b>	
R	17-18	<b>VOLVO VAH SERIES</b>	
R	16-20	VNL 300 All Models with 40,000 lb Rear Air Suspension	
R	11-18	VNL 430	
R	15-16	VNL 430 All Models with 40,000 lb Rear Air Suspension	
R	11-19	VNL 630	
R	15-16	VNL 630 All Models with 40,000 lb Rear Air Suspension	
R	11-19	VNL 670	
R	15-16	VNL 670 All Models with 40,000 lb Rear Air Suspension	
R	17-20	VNL 740 All Models with 40,000 lb Rear Air Suspension	
R	17-20	VNL 760 All Models with 40,000 lb Rear Air Suspension	
R	17-20	VNL 860 All Models with 40,000 lb Rear Air Suspension	
R	11-18	<b>VNL SERIES</b>	
R	<b>VNM SERIES</b>		
R	18-19	VNR All 300 Models with 40,000 lb Rear Air Suspension	
R	18-19	VNR All 400 Models with 38,000 lb Rear Air Suspension	
R	<b>VNR SERIES</b>		
R	<b>VNX - SERIES</b>		
85090	W		
R	89-24	<b>BLUE BIRD ALL AMERICAN FE</b> All Buses with Leaf Spring Rear Suspension	
R	89-24	<b>ALL AMERICAN RE</b> All Buses with Leaf Spring Rear Suspension	

## 85000 Series

Shock	POP	Alternative No.	MTG Acc. Supplied
Pos.	Year	Application	
85090	W (cont)		
R	10-13	D3 SERIES (FE & RE MODELS)	
R	04-24	VISION SCHOOL BUS All Buses with Leaf Spring Rear Suspension	
85102	W		
R	<b>HENDRICKSON TRUCK SUSPENSION SYSTEMS HTB 400 LT - SERIES</b>		
R	17-23	<b>INTERNATIONAL LT625</b> All Models with Hendrickson HTB 400LT Rear Air Suspension	
R	20	LT All Models with Hendrickson HTB 400LT Rear Air Suspension	
R	<b>PROSTAR</b>		
85106	W		
F	<b>BLUE BIRD ADDITIONAL APPLICATIONS</b>		
F	10-19	ALL AMERICAN FE All Buses with Hendrickson Softek Suspension (13,200 lb - 14,600 lb Capacity)	
F	10-19	ALL AMERICAN RE All Buses with Hendrickson Softek Suspension (13,200 lb - 14,600 lb Capacity)	
F	10-13	D3 SERIES (FE & RE MODELS)	
F	10-19	VISION SCHOOL BUS All Buses with Hendrickson Softek Suspension (13,200 lb - 14,600 lb Capacity)	
F	21-22	LION LION8 All Trucks with Hendrickson Softek Suspension (14,600 lb Capacity)	
85109	D		
R	18-19	<b>KENWORTH C500</b> All Models with Neway ADZ Rear Suspension	
R	10-16	C500 All Models with Neway ADZ Rear Suspension	
R	12-21	T440	
R	10-20	T470	
R	11-23	T680 All Models with Neway ADZ Rear Suspension	
R	10-23	T800 All Models with Neway ADZ Rear Suspension	
R	11-24	T880 All Models with Neway ADZ Rear Suspension	
R	10-24	W900 All Models with Neway ADZ Rear Suspension	
R	19-24	W990 All Models with Neway ADZ Rear Suspension	
R	10-18	<b>PETERBILT 320</b> All Models with Neway ADZ Rear Suspension	
R	10-23	337 All Models with Neway ADZ Rear Suspension	
R	10-23	348 All Models with Neway ADZ Rear Suspension	
R	10-23	365 All Models with Neway ADZ Rear Suspension	
R	10-23	367 All Models with Neway ADZ Rear Suspension	
R	14-23	389 All Models with Neway ADZ Rear Suspension	
R	17-23	520 All Models with Neway ADZ Rear Suspension	
R	14-24	567 All Models with Neway ADZ Rear Suspension	
R	13-24	579 All Models with Neway ADZ Rear Suspension	
R	10-23	<b>SAF HOLLAND TRUCK, BUS &amp; MOTORHOME AIR SUSPENSIONS</b>	
R	10-22	<b>VOLVO VHD</b> All Models with Neway ADZ Rear Suspension	
R	10-22	VNL All Models with Neway ADZ Rear Suspension	
R	19-21	VNX All Models with Neway ADZ Rear Suspension	
R	15-17	VNX All Models with Neway ADZ Rear Suspension	
R	22-24	<b>WESTERN STAR 47X</b> All Models with Neway ADZ Rear Suspension	
R	21-24	49X All Models with Neway ADZ Rear Suspension	
R	10-23	4900SA All Models with Neway ADZ Rear Suspension	
85119	D		
F	13-18	<b>KENWORTH T660</b> All Models with O.E.M. Number	
F	13-24	T680 All Models with O.E.M. Number	
F	14-16	T880 All Models with O.E.M. Number	
F	19-24	W990 All Models with O.E.M. Number	
F	15-16	<b>PETERBILT 348</b> All Models with O.E.M. Number	

## Numerical listing

Shock	POP	Alternative No.	MTG Acc. Supplied
Pos.	Year	Application	
85119	D (cont)		
F	15-24	389 All Models with O.E.M. Number	
F	22-24	567 All Models with O.E.M. Number	
F	13-22	579 All Models with O.E.M. Number	
85124	W	145054 (2)	
R	04-11	<b>DAMON CLASS A MOTORHOMES</b>	
R	04-11	<b>FLEETWOOD CLASS A MOTORHOMES</b>	
R	04-11	<b>HOLIDAY RAMBLER CLASS A MOTORHOMES</b>	
R	04-11	<b>ITASCA CLASS A MOTORHOMES</b>	
R	09	<b>MONACO COACH LA PALMA</b> All Models with W20 & W22 Workhorse Motorhome Chassis	
R	04-06	LA PALMA All Models with W20 & W22 Workhorse Motorhome Chassis	
R	06-11	MONARCH All Models with W20 & W22 Workhorse Motorhome Chassis	
R	04-08	<b>NATIONAL RV CLASS A MOTORHOMES</b>	
85125	W		
F	98-11	<b>DAMON CLASS A MOTORHOMES</b>	
F	98-11	<b>HOLIDAY RAMBLER CLASS A MOTORHOMES</b>	
F	98-11	<b>ITASCA CLASS A MOTORHOMES</b>	
F	98-11	<b>MONACO COACH CLASS A MOTORHOMES</b>	
F	09	LA PALMA All Models with W20 & W22 Workhorse Motorhome Chassis	
F	02-06	LA PALMA All Models with W20 & W22 Workhorse Motorhome Chassis	
F	00	LA PALMA All Models with W20 & W22 Workhorse Motorhome Chassis	
F	06-11	MONARCH All Models with W20 & W22 Workhorse Motorhome Chassis	
F	01-02	MONARCH All Models with W20 & W22 Workhorse Motorhome Chassis	
F	98-08	<b>NATIONAL RV CLASS A MOTORHOMES</b>	
85180	W		
R	21-24	<b>FORD F-650</b> All Models with 13,500, 15,500 & 19,000 lb Multi-leaf Rear Springs	
R	15-19	F-650 All Models with 13,500, 15,500 & 19,000 lb Multi-leaf Rear Springs	
R	21-24	F-750 All Models with 13,500, 15,500 & 19,000 lb Multi-leaf Rear Springs	
R	15-19	F-750 All Models with 13,500, 15,500 & 19,000 lb Multi-leaf Rear Springs	
R	15-23	<b>GLAVAL BUS CO. CONCORDE II - SERIES</b>	
R	15-23	<b>STARCRAFT BUS CO. ALLSTAR XL &amp; XLT - SERIES</b>	
85181	W		
F	21-24	<b>FORD F-650</b> All Models with 19.5" or 22.5" Wheels (22,000 lb GVW)	
F	15-19	F-650 All Models with 19.5" or 22.5" Wheels (22,000 lb GVW)	
F	21-24	F-750 All Models with 19.5" or 22.5" Wheels (22,000 lb GVW)	
F	15-19	F-750 All Models with 19.5" or 22.5" Wheels (22,000 lb GVW)	
F	15-23	<b>GLAVAL BUS CO. CONCORDE II - SERIES</b>	
F	15-23	<b>STARCRAFT BUS CO. ALLSTAR XL &amp; XLT - SERIES</b>	
85182	W	145089-200 (2)	
F	13-24	<b>KENWORTH K370</b> All Models with 10,000 lb to 12,000 lb Front Axle	
F	13-24	<b>PETERBILT 220</b> All Models with 12,000 lb Front Axle	
85188	D		
R	21-24	<b>MACK ANTHEM</b> All Anthem 64T Models with O.E.M. Number	
R	21-24	MD7 All Models with O.E.M. Number	
R	21-24	<b>VOLVO VNL</b> All All Models with O.E.M. Number	
R	21-22	VNL All 300 Models with O.E.M. Number	
R	21-24	VNL 300	
R	21-24	VNL 740	
R	20	VNL 740 All Models with 40,000 lb Rear Air Suspension	
R	21-24	VNL 760	
R	20	VNL 760 All Models with 40,000 lb Rear Air Suspension	



Numerical listing

Shock	POP	Alternative No.	MTG Acc. Supplied
Pos.	Year	Application	
85188	D (cont)		
R	21-24	VNL 860	
R	21-23	VNR All 300 Models with O.E.M. Number	
R	21-24	VNR 300	
R	21-24	VNR 400	
85200	W		
F	18-24	FREIGHTLINER CASCADIA All Models with Hendrickson Airtek NXT Front	
F	23-24	WESTERN STAR 57X All Models with Hendrickson Airtek NXT Front	
85205	N		
R	16-24	FREIGHTLINER CASCADIA All Models with Airliner Rear Air Suspension with O.E.M. Number	
R	16-24	M2 112 All Models with Airliner Rear Air Suspension with O.E.M. Number	
R	21-24	WESTERN STAR 49X All Models with Airliner Rear Air Suspension with O.E.M. Number	
85300	D	401754 (4)	
R		FRUEHAUF VARIOUS	
R		HOBBS TRAILER VARIOUS	
R		INTERNATIONAL CARGOSTAR CO-TRANSTAR AND TRANSTAR II	
R		FLEETSTAR - CONVENTIONAL	
R		LOADSTAR - CONVENTIONAL	
R		TRANSTAR - CONVENTIONAL	
F		OSTERLUND TRUCK VARIOUS	
F		OTTAWA VARIOUS	
R		REYCO SUSPENSION TRAILER	
R		SAF HOLLAND TRUCK, BUS & MOTORHOME AIR SUSPENSIONS	
R		TRUCK & TRACTOR AIR SUSPENSION (TAG AXLE)	
R		SEAGRAVE FIRE APPARATUS LLC VARIOUS	
R		TUTHILL TECHNOLOGIIES TRAILER	
R		WABASH NATIONAL VARIOUS	
R		WATSON & CHALIN MFG. INC. LIGHT WEIGHT TRAILER AIR SUSPENSION	
R		WESTERN UNIT STABILAIR SUSPENSION VARIOUS	
85301	W	401754 (4)	
R		BECK BUS VARIOUS	
F		CLARK EQUIPMENT VARIOUS	
F	86-97	FORD CF7000 All Models with 12000 lb or 13000 lb Axle	
F	87-97	CF8000 All Models with 12000 lb or 13000 lb Axle	
F	86-89	CF SERIES (BRAZILIAN BUILT)	
F	81-91	CL9000 All Models with O.E.M. Number	
F	78-80	CL & CLT SERIES - HIGHWAY TRACTOR TILT CAB	
F	81-91	CLT9000 All Models with O.E.M. Number	
F	66-77	W AND WT SERIES - HI TILT CAB HIGHWAY TRACTOR	
R		SAF HOLLAND TRUCK & TRACTOR AIR SUSPENSION (TAG AXLE)	
85302	W	401754 (4)	
R		AM GENERAL VARIOUS	
F	66-69	CHEVROLET 8, 80 & 8000 SERIES	
R	86-97	FORD CF7000 All Models with 12000 lb or 13000 lb Axle	
R	87-97	CF8000 All Models with 12000 lb or 13000 lb Axle	
F		FREIGHTLINER CLASSIC/CLASSICXL	
F		FWD CORPORATION VARIOUS	
F	66-72	GMC 8500 SERIES	
F	66-72	9500 SERIES	
F		MACK F SERIES	
F	84-87	PETERBILT 349 All 349 Conventional Models with 12000 lb capacity	
F	81-88	353 All 353 Conventional Models with 12000 lb capacity	
F	81-87	359 All 359 Conventional Models with 12000 lb capacity	
F		362	
F	81-06	362 All C.O.E. Models without Set Back Front Axle	
R		RIDEWELL CORP. TRUCK AIR-RIDES	

85000 Series

Shock	POP	Alternative No.	MTG Acc. Supplied
Pos.	Year	Application	
85303	D	401754 (4)	
F		BROCKWAY SCHOOL BUS VARIOUS	
F		BUILT RITE VARIOUS	
F		BUS & TRUCK CO. VARIOUS	
R	73-80	CHEVROLET 7, 70 & 7000 SERIES	
R	73-80	7, 70 & 7000 SERIES	
R	73-80	8, 80 & 8000 SERIES	
F	70-80	8, 80 & 8000 SERIES	
F	70-80	9000 SERIES	
F		CONTINENTAL TRAILWAYS-EAGLE INTL. VARIOUS	
F		CROWN COACH VARIOUS	
F		EAGLE MOTOR COACH VARIOUS	
R	73-80	GMC 7500 SERIES	
R	70-80	7500 SERIES	
F	73-80	8500 SERIES	
R	73-80	8500 SERIES	
F	66-80	9500 SERIES	
F		GREYHOUND BUS VARIOUS	
F		INTERNATIONAL CO-TRANSTAR AND TRANSTAR II	
F		F & S SERIES	
F		LOADSTAR - CONVENTIONAL	
F		PAYSTAR - 5000 SERIES	
F		TRANSTAR - CONVENTIONAL	
F		UNISTAR	
F		MC NEILUS TRUCK & MAN. VARIOUS	
F		ORION BUS VARIOUS	
F		OSHKOSH MOTOR TRUCK CO. VARIOUS	
F		TRANSPORTATION MFG. CORP. VARIOUS	
85304	W	401754 (4)	
F		BECK BUS VARIOUS	
F		BLUE BIRD ADDITIONAL APPLICATIONS	
R		ADDITIONAL APPLICATIONS	
F		ALL AMERICAN SERIES (FE & RE MODELS)	
R		ALL AMERICAN SERIES (FE & RE MODELS)	
F		BROCKWAY SCHOOL BUS VARIOUS	
R	73-78	CHEVROLET 6, 60, 6000 & 6500 SERIES	
F	83-84	7, 70 & 7000 SERIES	
F	66-80	7, 70 & 7000 SERIES	
R	66-86	8, 80 & 8000 SERIES	
F	79-82	8, 80 & 8000 SERIES	
F	70-86	9000 SERIES	
F		CONTINENTAL TRAILWAYS-EAGLE INTL. VARIOUS	
F		CROWN COACH VARIOUS	
F		DIAMOND REO VARIOUS	
F		DIAMOND T VARIOUS	
F		EAGLE MOTOR COACH VARIOUS	
F	66-71	FORD W AND WT SERIES - HI TILT CAB HIGHWAY TRACTOR	
F		GILLIG VARIOUS	
F	66-80	GMC 7500 SERIES	
F	66-86	8500 SERIES	
R	79-82	8500 SERIES	
R	73-89	9500 SERIES	
F		MACK ADDITIONAL APPLICATIONS	
R		RIDEWELL CORP. TRUCK AIR-RIDES	
R		SAF HOLLAND TRUCK & TRACTOR AIR SUSPENSION (TAG AXLE)	
F		SOUTHERN COACH VARIOUS	
F		THOMAS VARIOUS	
R		UNITED MANUFACTURING VARIOUS	
F		VOLVO ADDITIONAL APPLICATIONS	
R		WESTERN UNIT STABILAIR SUSPENSION VARIOUS	
85305	W	401754 (4)	
F		BROCKWAY SCHOOL BUS VARIOUS	
R		VARIOUS	
F		BUILT RITE VARIOUS	
F		BUS & TRUCK CO. VARIOUS	
F		CONTINENTAL TRAILWAYS-EAGLE INTL. VARIOUS	
F		EAGLE MOTOR COACH VARIOUS	
R		FORD VARIOUS	
R		FRUEHAUF VARIOUS	
R		MACK ADDITIONAL APPLICATIONS	

Numerical listing

Shock	POP	Alternative No.	MTG Acc. Supplied
Pos.	Year	Application	
85305	W (cont)	401754 (4)	
R		F SERIES	
F	81-91	R All Models with O.E.M. Number	
F	07	RD All Models with O.E.M. Number	
F	81-04	RD All Models with O.E.M. Number	
R		MC NEILUS TRUCK & MAN. VARIOUS	
F		PAI CORP. VARIOUS	
R		RIDEWELL CORP. TRUCK AIR-RIDES	
R		WESTERN UNIT STABILAIR SUSPENSION VARIOUS	
85307	W	401754 (4)	
F		BECK BUS VARIOUS	
F		BLUE BIRD ADDITIONAL APPLICATIONS	
F		ALL AMERICAN SERIES (FE & RE MODELS)	
F		BROCKWAY SCHOOL BUS VARIOUS	
R	73-80	CHEVROLET 7, 70 & 7000 SERIES	
R	73-80	8, 80 & 8000 SERIES	
R		CLARK EQUIPMENT VARIOUS	
F		CONTINENTAL TRAILWAYS-EAGLE INTL. VARIOUS	
F		DIAMOND REO VARIOUS	
R		VARIOUS	
F		EAGLE MOTOR COACH VARIOUS	
F		VARIOUS	
F		FLXIBLE TRANSIT BUS VARIOUS	
R	60-68	GMC 5500 SERIES	
F	60-68	6000 SERIES	
R	73-80	7500 SERIES	
R	73-80	8500 SERIES	
R		INTERNATIONAL FIRETRUCK S SERIES SCHOOL BUS	
R		ONEIDA PRODUCTS VARIOUS	
F		PIERCE MFG. INC. VARIOUS	
F		REYCO SUSPENSION STEER AXLE	
R		RIDEWELL CORP. TRUCK AIR-RIDES	
F		SPARTAN MOTORS VARIOUS	
R		THOMAS VARIOUS	
R		WESTERN UNIT STABILAIR SUSPENSION VARIOUS	
85308	W	401754 (4)	
F		ACF BRILL BUS VARIOUS	
F	73-80	CHEVROLET 7, 70 & 7000 SERIES	
F	73-80	8, 80 & 8000 SERIES	
F		EAGLE MOTOR COACH VARIOUS	
F		FREIGHTLINER CLASSIC/CLASSICXL	
F	73-80	GMC 7500 SERIES	
F	73-80	8500 SERIES	
F		INTERNATIONAL S SERIES SCHOOL BUS	
F		TRANSTAR - CONVENTIONAL	
R		ORION BUS VARIOUS	
R		PETERBILT 362	
R		VOLVO ADDITIONAL APPLICATIONS	
F		WESTERN STAR 5900 & 6900 SERIES - HERITAGE CLASS	
R		WESTERN UNIT STABILAIR SUSPENSION VARIOUS	
85310	B	141108 (1)	
R		INTERNATIONAL VARIOUS	
R		KENWORTH C500, C500B, C500K, C540 & C550	
R		K100, K100E, K125	
R	93-05	K300 All All with Air Glide 100 Suspension with 8 air bags, 4 units required	
R		T300	
R		T400, T400B, T450B	
R		T600, T600A, T600B, T602	
R		T800, T800B, T800B(8X4), T800SH, T800H, T800W	
R	97-11	T2000 All All with Air Glide 100 Suspension with 8 air bags, 4 units required	
R		W900, W900B, W900L, W900S	
R		OTTAWA VARIOUS	
85311	A	141247 (1)	
F		INTERNATIONAL SERIES 400, 500, 600, 700 & 900-MED CABOV TRK&TRAC NISS VARIOUS	
R		LEYLAND TRUCK VARIOUS	



Numerical listing

Shock	POP	Alternative No.	MTG Acc. Supplied
Pos.	Year	Application	
<b>85311</b>	A (cont)	<b>141247 (1)</b>	
R	87-18	<b>PETERBILT 320</b>	All Models with Air Trac Suspension (46,000 lb)
R	07-21	<b>330</b>	All Models with Air Trac Suspension (46,000 lb)
R	95-05	<b>330</b>	All Models with Air Trac Suspension (46,000 lb)
R	05-10	<b>335</b>	All Models with Air Trac Suspension (46,000 lb)
R	10-23	<b>337</b>	All Models with Air Trac Suspension (46,000 lb)
R	07-10	<b>340</b>	All Models with Air Trac Suspension (46,000 lb)
R	10-23	<b>348</b>	All Models with Air Trac Suspension (46,000 lb)
R	87-08	<b>357</b>	All Models with Air Trac Suspension (46,000 lb)
R	81-87	<b>359</b>	All Models with Air Trac Suspension (46,000 lb)
R	81-06	<b>362</b>	All Models with Air Trac Suspension (46,000 lb)
R	08-23	<b>365</b>	All Models with Air Trac Suspension (46,000 lb)
R	08-24	<b>367</b>	All Models with Air Trac Suspension (46,000 lb)
R	89-93	<b>372</b>	All Models with Air Trac Suspension (46,000 lb)
R	87-96	<b>375</b>	All Models with Air Trac Suspension (46,000 lb)
R	02	<b>376</b>	
R	00	<b>376</b>	
R	99	<b>376</b>	All Models with Air Trac Suspension (46,000 lb)
R	94-96	<b>376</b>	All Models with Air Trac Suspension (46,000 lb)
R	88-92	<b>376</b>	All Models with Air Trac Suspension (46,000 lb)
R	87-01	<b>377</b>	All Models with Air Trac Suspension (46,000 lb)
R	88-07	<b>378</b>	All Models with Air Trac Suspension (46,000 lb)
R	86-07	<b>379</b>	All Models with Air Trac Suspension (46,000 lb)
R	11-17	<b>382</b>	All Models with Air Trac Suspension (46,000 lb)
R	08-16	<b>384</b>	All Models with Air Trac Suspension (46,000 lb)
R	95-07	<b>385</b>	All Models with Air Trac Suspension (46,000 lb)
R	06-16	<b>386</b>	All Models with Air Trac Suspension (46,000 lb)
R	06-16	<b>386</b>	All Models with Peterbilt Air Leaf Suspension
R	00-11	<b>387</b>	All Models with Peterbilt Air Leaf Suspension
R	08-15	<b>388</b>	All Models with Air Trac Suspension (46,000 lb)
R	08-15	<b>388</b>	All Models with Peterbilt Air Leaf Suspension
R	14-24	<b>389</b>	All Models with Air Trac Suspension (46,000 lb)
R	08-13	<b>389</b>	All Models with Peterbilt Air Leaf Suspension
R	17-23	<b>520</b>	All Models with Air Trac Suspension (46,000 lb)
R	14-24	<b>567</b>	All Models with Air Trac Suspension (46,000 lb)
R	13-24	<b>579</b>	All Models with Air Trac Suspension (46,000 lb)
R	11-18	<b>587</b>	All Models with Air Trac Suspension (46,000 lb)
<b>85314</b>	W	<b>401754 (4)</b>	
R	08-20	<b>AUTOCAR LLC. XPEDITOR</b>	All 8 X 4 Models with Chalmers 800 Series - 46K Tandem Truck Suspensions ( HD Shock Kit with Low Mounts)
R		<b>CHALMERS SUSPENSION</b>	VARIOUS
F		<b>EAGLE MOTOR COACH</b>	VARIOUS
R	96-98	<b>FORD A9513</b>	All All with 23000 lb Axle and 52" Taperleaf spring
R	97	<b>A9522</b>	All All with 23000 lb Axle and 52" Taperleaf spring
R	96-98	<b>AT9513</b>	All All with 23000 lb Axle and 52" Taperleaf spring
R	97-98	<b>AT9522</b>	All All with 23000 lb Axle and 52" Taperleaf spring
R	94	<b>B-700</b>	All Models with with 15000, 17500, 19000 lb Taperleaf Springs
R	95-97	<b>B-800</b>	All Models with with 15000, 17500, 19000 lb Taperleaf Springs
R	94-98	<b>F-700</b>	All Models with with 15000, 17500, 19000 lb Taperleaf Springs

85000 Series

Shock	POP	Alternative No.	MTG Acc. Supplied
Pos.	Year	Application	
<b>85314</b>	W (cont)	<b>401754 (4)</b>	
R	94-98	<b>F-800</b>	All Models with with 15000, 17500, 19000 lb Taperleaf Springs
R	94-98	<b>FT900</b>	All Models with 46" Taperleaf Spring and 15000, 17500 or 19000 lb Axle
R		<b>KENWORTH C500, C500B, C500K, C540 &amp; C550</b>	
R		<b>K100, K100E, K125</b>	
R		<b>T400, T400B, T450B</b>	
R		<b>T800, T800B, T800B(8X4), T800SH, T800H, T800W</b>	
R		<b>W900, W900B, W900L, W900S</b>	
R	99-10	<b>STERLING TRUCK A9500</b>	All All Models with 23000 lb Axle and 52" Taperleaf Softride Rear Suspension
R	99-01	<b>A9513</b>	All All Models with 23000 lb Axle and 52" Taperleaf Softride Rear Suspension
R	99	<b>A9522</b>	All All Models with 23000 lb Axle and 52" Taperleaf Softride Rear Suspension
R	99-10	<b>L8500</b>	All All Models with 23000 lb Axle and 52" Taperleaf Softride Rear Suspension
R	99	<b>L8501</b>	All All Models with 23000 lb Axle and 52" Taperleaf Softride Rear Suspension
R	99-00	<b>L8511</b>	All All Models with 23000 lb Axle and 52" Taperleaf Softride Rear Suspension
R	99-01	<b>L8513</b>	All All Models with 23000 lb Axle and 52" Taperleaf Softride Rear Suspension
R	99-10	<b>L9500</b>	All All Models with 23000 lb Axle and 52" Taperleaf Softride Rear Suspension
R	99-00	<b>L9501</b>	All All Models with 23000 lb Axle and 52" Taperleaf Softride Rear Suspension
R	99-01	<b>L9511</b>	All All Models with 23000 lb Axle and 52" Taperleaf Softride Rear Suspension
R	99-00	<b>L9513</b>	All All Models with 23000 lb Axle and 52" Taperleaf Softride Rear Suspension
R	99	<b>L9522</b>	All All Models with 23000 lb Axle and 52" Taperleaf Softride Rear Suspension
<b>85315</b>	W	<b>401754 (4)</b>	
F		<b>CLARK EQUIPMENT</b>	VARIOUS
R		<b>CUNHA PRODUCTS</b>	OHV VARIOUS
R	86-89	<b>FORD CF SERIES</b>	(BRAZILIAN BUILT)
F		<b>JIFFLOX</b>	VARIOUS
F		<b>KWK-LOC (JIFFLOX)</b>	VARIOUS
R		<b>WESTERN STAR 5900 &amp; 6900</b>	SERIES - HERITAGE CLASS
<b>85316</b>	D	<b>145090 (1)</b>	
F	10-11	<b>INTERNATIONAL PAYSTAR</b>	5000 SERIES
F		<b>SERIES 2000 - CONVENTIONAL TRUCK</b>	(SEVERE SERVICE)
F	90-02	<b>SERIES 4000 - SHORT CONVENTIONAL MEDIUM TRK &amp; TRAC</b>	
F		<b>SERIES 8000 - CONVENTIONAL HEAVY DUTY TRACTOR</b>	
F		<b>SERIES 9100, 9100I - TRACTOR &amp; STRAIGHT TRUCK</b>	
F		<b>SERIES 9200, 9200I - TRACTOR &amp; STRAIGHT TRUCK</b>	
F		<b>SERIES 9300, 9300I, 9400 &amp; 9400I</b>	LONG HOOD CONV.
F		<b>SERIES 9600 &amp; 9700 PREMIUM</b>	CABOVER TRACTOR
F		<b>SERIES 9800 - PREMIUM</b>	CABOVER TRACTOR
F		<b>SERIES 9900, 9900I, 9900IX</b>	LONG HOOD CONV. TRUCK
F		<b>VARIOUS</b>	
F		<b>OSHKOSH MOTOR TRUCK CO.</b>	VARIOUS
F		<b>PIERCE MFG. INC.</b>	VARIOUS
<b>85318</b>	W	<b>145054 (2)</b>	
R		<b>GILLIG</b>	VARIOUS
R		<b>HAUSMAN</b>	VARIOUS
<b>85319</b>	D	<b>145089-000 (1)</b>	
R	89-99	<b>FREIGHTLINER FLA086</b>	All Models with Airliner Rolling Lobe Spring Air Suspension

Numerical listing

Shock	POP	Alternative No.	MTG Acc. Supplied
Pos.	Year	Application	
<b>85319</b>	D (cont)	<b>145089-000 (1)</b>	
R	02	<b>FLB</b>	All Models with Airliner Rolling Lobe Spring Air Suspension
R	94-99	<b>FLB</b>	All Models with Airliner Rolling Lobe Spring Air Suspension
R		<b>INTERNATIONAL</b>	VARIOUS
<b>85320</b>	B	<b>401754 (4)</b>	
F		<b>FREIGHTLINER</b>	CLASSIC/CLASSICXL
F	89-99	<b>FLA086</b>	All Models with O.E.M. Number
F	94-99	<b>FLB</b>	All Models with O.E.M. Number
F	85-97	<b>FLC112</b>	All Models with O.E.M. Number
F	91	<b>FLC120</b>	All Models with O.E.M. Number
F	87-88	<b>FLC120</b>	All Models with O.E.M. Number
F	91-08	<b>FLD112</b>	All Models with O.E.M. Number
F	88-11	<b>FLD120</b>	All Models with O.E.M. Number
F	05-12	<b>FLD120SD</b>	All Models with O.E.M. Number
F	03	<b>FLD120SD</b>	All Models with O.E.M. Number
F	03-11	<b>FLD132</b>	All Models with O.E.M. Number
F	01	<b>FLD132</b>	All Models with O.E.M. Number
<b>85321</b>	W	<b>401754 (2)</b>	
R		<b>FRUEHAUF</b>	VARIOUS
R		<b>HOLLAND-BINKLEY</b>	VARIOUS
F	91-07	<b>MACK CL</b>	All CL600, CL700 Models with Multileaf Spring Suspension
R		<b>SAF HOLLAND TRUCK, BUS &amp; MOTORHOME AIR SUSPENSIONS</b>	
R		<b>WABASH NATIONAL</b>	VARIOUS
R		<b>WATSON &amp; CHALIN MFG. INC.</b>	VARIOUS
<b>85322</b>	W	<b>401754 (2)</b>	
R		<b>FRUEHAUF</b>	VARIOUS
R		<b>WABASH NATIONAL</b>	VARIOUS
<b>85323</b>	A	<b>401754 (4)</b>	
R		<b>EAST MANUFACTURING CORP.</b>	VARIOUS
R		<b>GREAT DANE TRAILER</b>	VARIOUS
R		<b>HENDRICKSON TRAILER</b>	SUSPENSION SYSTEMS INTRAAAX
R		<b>TOP MOUNT STYLE</b>	
R		<b>UNDERSLUNG STYLE</b>	
R		<b>INGERSOLL AXLES</b>	VARIOUS
R		<b>MC NEILUS TRUCK &amp; MAN.</b>	VARIOUS
R		<b>SAF HOLLAND TRAILER AIR SUSPENSION</b>	
R		<b>UTILITY TRAILER</b>	
R		<b>MANUFACTURING COMPANY</b>	FLATBEDS
R		<b>WABASH NATIONAL</b>	VARIOUS
R		<b>WATSON &amp; CHALIN MFG. INC.</b>	VARIOUS
<b>85329</b>	W	<b>401754 (4)</b>	
F		<b>BLUE BIRD</b>	MOTORHOMES
F		<b>EMERGENCY ONE</b>	VARIOUS
F		<b>PREVOST</b>	VARIOUS
F	89-09	<b>VARIOUS</b>	
<b>85331</b>	C	<b>401754 (4)</b>	
R	99-15	<b>FREIGHTLINER ARGOSY</b>	All Models with Freightliner Low Profile Rear Air Suspension (18,000 to 40,000 lb)
R	96-11	<b>CENTURY CLASS</b>	All Models with Freightliner Low Profile Rear Air Suspension (18,000 to 40,000 lb)
R	05-15	<b>M2</b>	All Models with Freightliner Low Profile Rear Air Suspension (18,000 to 40,000 lb)
R	02-10	<b>M2 100</b>	All Models with Freightliner Low Profile Rear Air Suspension (18,000 to 40,000 lb)
R	05-06	<b>M2 106</b>	All Models with Freightliner Low Profile Rear Air Suspension (18,000 to 40,000 lb)
R	02-03	<b>M2 106</b>	All Models with Freightliner Low Profile Rear Air Suspension (18,000 to 40,000 lb)
R	03-15	<b>M2 112</b>	All Models with Freightliner Low Profile Rear Air Suspension (18,000 to 40,000 lb)

## Numerical listing

Shock	POP	Alternative No.	MTG Acc. Supplied
Pos.	Year	Application	
85331	C (cont)		
R		MB CHASSIS	
R	09-12	WESTERN STAR 4800 & 4900 SERIES - CONSTELLATION CLASS	
85332	W	145128 (1)	
F	03-18	IC CORPORATION RE SCHOOL BUS All RE Model School Buses with 12,000 to 14,000 lb Front Axles	
F		INTERNATIONAL SERIES 3000 - SCHOOL BUS CHASSIS	
85333	W	145128 (1)	
F		INTERNATIONAL SERIES 3000 - SCHOOL BUS CHASSIS	
F		SERIES 9300, 9300I, 9400 & 9400I LONG HOOD CONV.	
F		SERIES 9900, 9900I, 9900IX LONG HOOD CONV. TRUCK	
85334	W	401754 (4)	
F		ADVANCE MIXER VARIOUS	
F		MC NEILUS TRUCK & MAN. VARIOUS	
R		REYCO SUSPENSION TRAILER	
85335	W		
R	99-15	FREIGHTLINER ARGOSY All Models with Rear 10000 lb - 15000 lb Low Profile AirLiner	
R	05-21	M2 All Models with Rear 10000 lb - 15000 lb Low Profile AirLiner	
R	02-10	M2 100 All Models with Rear 10000 lb - 15000 lb Low Profile AirLiner	
R	05-06	M2 106 All Models with Rear 10000 lb - 15000 lb Low Profile AirLiner	
R	02-03	M2 106 All Models with Rear 10000 lb - 15000 lb Low Profile AirLiner	
R	03-23	M2 112 All Models with Rear 10000 lb - 15000 lb Low Profile AirLiner	
85337	D		
R		HENDRICKSON TRAILER SUSPENSION SYSTEMS INTRAAX	
85338	C		
R		HENDRICKSON TRAILER SUSPENSION SYSTEMS INTRAAX UTILITY TRAILER	
R		MANUFACTURING COMPANY FLATBEDS	
85339	W	401754 (4)	
R		MOTOR COACH INDUSTRIES ADDITIONAL APPLICATIONS	
R	13-15	D4005 All Models with O.E.M. Number (Trailing Axle)	
R	11	D4005 All Models with O.E.M. Number (Trailing Axle)	
R	05-09	D4005 All Models with O.E.M. Number (Trailing Axle)	
R	01-15	D - SERIES COACHES	
R	01-03	G - SERIES COACHES	
R		TRANSPORTATION MFG. CORP. VARIOUS	
85340	W	145089-000 (1)	
F		MOTOR COACH INDUSTRIES J4500	
85341	W	145089-000 (1)	
R	01-09	MOTOR COACH INDUSTRIES E - SERIES COACHES	
R	09-19	J4500 All Models with O.E.M. Number (Trailing Axle)	
R	07	J4500 All Models with O.E.M. Number (Trailing Axle)	
R	01-03	J4500 All Models with O.E.M. Number (Trailing Axle)	
R	08	J - SERIES COACHES	
R	04-06	J - SERIES COACHES	
85343	D	145089-000(1)/401754(2)	
R	97-08	PETERBILT 357 All Models with Air Track Tandem with TRD8000 Pusher Axle	
R		367	
R	22-24	567 All Models with Air Track Tandem with TRD8000 Pusher Axle	
85345	W		
R		HENDRICKSON TRAILER SUSPENSION SYSTEMS INTRAAX	
R		MC NEILUS TRUCK & MAN. VARIOUS	

## 85000 Series

Shock	POP	Alternative No.	MTG Acc. Supplied
Pos.	Year	Application	
85345	W (cont)		
R		WATSON & CHALIN MFG. INC. VARIOUS	
85351	W	145090 (1)	
F	03-18	IC CORPORATION RE SCHOOL BUS All RE Model School Buses with O.E.M number	
F		INTERNATIONAL S SERIES SCHOOL BUS	
85376	W	401754 (4)	
F	96	FORD AEROMAX (A, AT, AAT, 8500, 9500) SERIES	
F	92-97	CF7000 All Models with 9000 lb Axle	
F	92-97	CF8000 All Models with 9000 lb Axle	
F	92-97	CFT8000 All Models with 9000 lb Axle	
F	96	LA8000F All Models with 12000 or 13000 lb Axles	
F	98	STERLING TRUCK CARGO LINE	
F	98	L - LINE 8500 SERIES - CONVENTIONAL CAB	
85382	W		
R		HENDRICKSON TRAILER SUSPENSION SYSTEMS INTRAAX	
R		UNDERSLUNG STYLE	
R		WATSON & CHALIN MFG. INC. VARIOUS	
85637	W		
F	14-17	INTERNATIONAL 8600 TRANSTAR All Models with O.E.M. Number	
F	15-17	TRANSTAR All Models with O.E.M. Number	
85638	W		
R		HENDRICKSON TRUCK SUSPENSION SYSTEMS	
R		ADDITIONAL APPLICATIONS	
85639	W		
F	14-16	INTERNATIONAL 9900I All Models with Sleeper Cab and 14,000 to 16,000 lb Taperleaf Front Spring Suspension	
F		SERIES 9900, 9900I, 9900IX LONG HOOD CONV. TRUCK	
85642	A		
R	17-23	INTERNATIONAL LONESTAR All Models with International 40,000 lb Rear Air Suspension (52" Spacing- Heavy Duty Rear)	
R	17-19	LONESTAR All Models with O.E.M. Number	
R	17-24	LT625 All Models with International 40,000 lb Rear Air Suspension (52" Spacing- Heavy Duty Rear)	
R	23-24	MV607 All Models with International 21,000 lb Rear Air Suspension	
R	21	PROSTAR	
R	17-20	PROSTAR All 6 x 4 Models with O.E.M. Number	
R	18-24	RH613 All Models with International 40,000 lb Rear Air Suspension	
85648	W		
F		INTERNATIONAL PAYSTAR - 5000 SERIES	
F		WORKSTAR - 7000 SERIES	
85656	C		
R	14	FORD F-650	
R	15	F-650 All Models with 21,000 lb Rear Air Suspension	
R	04-13	F-650 All Models with 21,000 lb Rear Air Suspension	
R	14	F-750	
R	15	F-750 All Models with 21,000 lb Rear Air Suspension	
R	04-13	F-750 All Models with 21,000 lb Rear Air Suspension	
R	04-15	GLAVAL BUS CO. CONCORDE II - SERIES	
R	10-23	IC CORPORATION CE SCHOOL BUS All CE Model School Buses with 20,000 lb International IROS Air Suspension	
R	10-18	INTERNATIONAL CE SERIES	
R		SCHOOL BUS	
R		DURASTAR - 4300, 4400 SERIES	
R	16-19	DURASTAR - 4300, 4400 SERIES	

## Numerical listing

Shock	POP	Alternative No.	MTG Acc. Supplied
Pos.	Year	Application	
85656	C (cont)		
R	20	MV All Models with 20,000 lb International IROS Air Suspension	
R		VARIOUS	
R	20-22	PIERCE MFG. INC. VARIOUS	
R	15	STARCRAFT BUS CO. ALLSTAR XL & XLT - SERIES	
85670	W		
R	23	INTERNATIONAL CV515 All Models with IROS Rear	
F	15-20	WORKSTAR 7300 All Models with 16,000 to 20,000 lb Front	
F	15-20	WORKSTAR 7400 All Models with 16,000 to 20,000 lb Front	
F	15-20	WORKSTAR 7600 All Models with 16,000 to 20,000 lb Front	
85671	W		
F	19-21	INTERNATIONAL VARIOUS	
85672	W		
R	19-21	INTERNATIONAL VARIOUS	
85700	W	401754 (4)	
F		GMC COACHES	
F		GREYHOUND BUS VARIOUS	
F		MOTOR COACH INDUSTRIES ADDITIONAL APPLICATIONS	
F		NOVA BUS CORPORATION VARIOUS	
F		SICARD VARIOUS	
F		TRANSPORTATION MFG. CORP. VARIOUS	
R		VARIOUS	
85702	W	401754 (4)	
R		ACF BRILL BUS VARIOUS	
R		HAUSMAN VARIOUS	
R	10	MACK LE All LE & LEU 613 Models with Ridewell RD-202S HD Tandem Drive Truck Suspension	
R	10-16	LEU All LE & LEU 613 Models with Ridewell RD-202S HD Tandem Drive Truck Suspension	
R		MOTOR COACH INDUSTRIES ADDITIONAL APPLICATIONS	
R		NOVA BUS CORPORATION VARIOUS	
R		REYCO SUSPENSION TRAILER	
R		RIDEWELL CORP. TRUCK AIR-RIDES	
R		SPARTAN MOTORS VARIOUS	
R		TRANSPORTATION MFG. CORP. VARIOUS	
R		TUTHILL TECHNOLOGIIES TRAILER	
85704	W	401754 (4)	
R		FLXIBLE TRANSIT BUS VARIOUS	
R		GRUMMAN BUS VARIOUS	
R		REYCO SUSPENSION DRIVE AXLE	
R		RIDEWELL CORP. TRUCK AIR-RIDES	
R		TUTHILL TECHNOLOGIIES DRIVE AXLE	
85705	W	145090 (2)	
F	93-03	MERCEDES-BENZ MP115	
R	93-03	MP115	
F	93-03	MP120	
R	93-03	MP120	
F		NEOPLAN VARIOUS	
R	96-07	SCANIA MARCO POLO	
F	96-03	MARCO POLO	
85708	W	145090 (2)	
F		ABC BUS VARIOUS	
R		FLYER INDUSTRIES VARIOUS	
F		MAN VARIOUS	
R		VARIOUS	
R		MOTOR COACH INDUSTRIES ADDITIONAL APPLICATIONS	
R		NEW FLYER VARIOUS	
R	02-21	VARIOUS	
F		NORTH AMERICAN BUS INDUSTRIES VARIOUS	
R		VARIOUS	
F		VAN HOOL VARIOUS	
R		VARIOUS	
85709	W	145090 (2)	
R		MAN VARIOUS	

## Numerical listing

Shock	POP	Alternative No.	MTG Acc. Supplied
Pos.	Year	Application	
85711	W	145054(1)/401754(2)	
F		<b>GMC COACHES</b>	
F	01-09	<b>MOTOR COACH INDUSTRIES</b>	
		E4500	
F	01-03	G4500	
F	08	J4500	
F	04-06	J4500	
F	09-19	J4500 All Front Axle with OEM Number	
F	07	J4500 All Front Axle with OEM Number	
F	01-03	J4500 All Front Axle with OEM Number	
F		<b>TRANSPORTATION MFG. CORP. VARIOUS</b>	
85712	C	401754 (4)	
F		<b>BLUE BIRD ADDITIONAL APPLICATIONS</b>	
F		<b>MOTORHOMES</b>	
F	89-04	TC2000 All Buses with Ridewell Front Suspension with O.E.M. Number	
R		<b>WANDERLODGE</b>	
F		<b>CARPENTER BUS VARIOUS</b>	
F	00-10	<b>COUNTRY COACH AFFINITY</b> All MotorHomes with Ridewell Front Suspension	
F	00	<b>CONCEPT</b> All MotorHomes with Ridewell Suspension	
F	00-04	<b>MAGNA</b> All MotorHomes with Ridewell Suspension	
F	05-10	<b>MAGNA 630</b> All MotorHomes with Ridewell Suspension	
R		<b>CRANE CARRIER VARIOUS</b>	
R		<b>DIAMOND REO VARIOUS</b>	
R		<b>FLUIDRIVE VARIOUS</b>	
F		<b>GILLIG VARIOUS</b>	
R		<b>GRANNING SUSPENSION VARIOUS</b>	
R		<b>MERITOR VARIOUS</b>	
R		<b>ORION BUS VARIOUS</b>	
R		<b>OSTERLUND TRUCK VARIOUS</b>	
R		<b>RAYDAN MANUFACTURING VARIOUS</b>	
F		<b>RIDEWELL CORP. TRUCK AIR-RIDES</b>	
R		<b>TRUCK AIR-RIDES</b>	
F		<b>SEAGRAVE FIRE APPARATUS LLC VARIOUS</b>	
F		<b>SPARTAN MOTORS VARIOUS</b>	
F		<b>VARIOUS</b>	
R	86	<b>TUTHILL TECHNOLOGIIES TRAILER</b>	
85713	W	401754 (4)	
R		<b>CARPENTER BUS VARIOUS</b>	
R		<b>EAGLE MOTOR COACH VARIOUS</b>	
R		<b>MOTOR COACH INDUSTRIES</b>	
R		<b>ADDITIONAL APPLICATIONS</b>	
R		<b>NOVA BUS CORPORATION VARIOUS</b>	
R		<b>PREVOST VARIOUS</b>	
R	04-09	<b>VARIOUS</b>	
R		<b>TRANSPORTATION MFG. CORP. VARIOUS</b>	
85716	W	145093 (1)	
R	90-94	<b>FORD F-600 LPO</b> All Models with O.E.M. Number	
R	90-94	<b>F-700 LPO</b> All Models with O.E.M. Number	
R	90-92	<b>FT900</b> All Low Profile Models with O.E.M. Number	
F		<b>ORION BUS VARIOUS</b>	
R		<b>VARIOUS</b>	
85720	W	401754 (4)	
F		<b>ORION BUS VARIOUS</b>	
F		<b>OTTAWA VARIOUS</b>	
85722	W	145090 (2)	
F	91-21	<b>FLYER INDUSTRIES VARIOUS</b>	
F		<b>MAN VARIOUS</b>	
F	91-21	<b>NEW FLYER VARIOUS</b>	
R		<b>VOLVO FE SERIES</b>	
85723	W	145075 (1)	
F	00-10	<b>COUNTRY COACH AFFINITY</b> All MotorHomes with Gillig Chassis w/ Neway I-beam front	
F	00-04	<b>ALLURE</b> All MotorHomes with Gillig Chassis w/ Neway I-beam front	
F	00	<b>CONCEPT</b> All MotorHomes with Gillig Chassis w/ Neway I-beam front	

## 85000 Series

Shock	POP	Alternative No.	MTG Acc. Supplied
Pos.	Year	Application	
85723	W (cont)	145075 (1)	
F	00-04	<b>INTRIGUE</b> All MotorHomes with Gillig Chassis w/ Neway I-beam front	
F	00-04	<b>MAGNA</b> All MotorHomes with Gillig Chassis w/ Neway I-beam front	
F	05-10	<b>MAGNA 630</b> All MotorHomes with Gillig Chassis w/ Neway I-beam front	
F		<b>GILLIG VARIOUS</b>	
85724	A		
R	13-24	<b>DYNAMAX CORP DX3</b> All Models with Airliner 21,000 lb Rear Air Suspension	
R	05-07	<b>DYNAQUEST</b> All Models with Airliner 18,000 lb Rear Air Suspension	
R	09-14	<b>DYNAQUEST ST</b> All Models with Airliner 18,000 lb Rear Air Suspension	
R	09-24	<b>DYNAQUEST XL</b> All Models with FAS II (40,000 lb) Rear Air Suspension	
R	21-24	<b>EUROPA</b> All Models with Airliner 21,000 lb Rear Air Suspension	
R	22	<b>FORCE HD</b> All Models with Airliner 21,000 lb Rear Air Suspension	
R	15-18	<b>FORCE HD</b> All Models with Airliner 21,000 lb Rear Air Suspension	
R	02-04	<b>GRAND SPORT</b> All Models 23,000 lb Airliner Rear Air Suspension	
R	09-14	<b>GRAND SPORT GT</b> All Models with Freightliner Airliner Rear Air Suspension	
R	07-13	<b>GRAND SPORT GT TOY HAULER</b> All Models 21K or 23K Airliner Rear Air Suspension	
R	03-07	<b>GRAND SPORT M2</b> All Models with Airliner 21,000 lb Rear Air Suspension	
R	07-14	<b>GRAND SPORT ULTRA</b> All Models 23,000 lb Airliner Rear Air Suspension	
R	20-24	<b>ENTEGR COACH ACCOLADE</b> All Models with Freightliner S2RV chassis	
R	21-24	<b>ACCOLADE XL</b> All Models with Freightliner S2RV chassis	
R	02-19	<b>FEDERAL COACH VARIOUS</b>	
R	12-24	<b>FREIGHTLINER 108SD</b> All Models with FAS II (40,000 lb) Rear Air Suspension	
R	12-24	<b>114SD</b> All Models with FAS II (40,000 lb) Rear Air Suspension	
R	13-23	<b>122SD</b> All Models with FAS II (40,000 lb) Rear Air Suspension	
R	99-15	<b>ARGOSY</b> All Models with FAS II (40,000 lb) Rear Air Suspension	
R	05-23	<b>B2</b> All Models with FAS II (40,000 lb) Rear Air Suspension	
R	08-24	<b>CASCADIA</b> All Models with FAS II (40,000 lb) Rear Air Suspension	
R	96-11	<b>CENTURY CLASS</b> All Models with FAS II (40,000 lb) Rear Air Suspension	
R	01-11	<b>CLASSIC</b> All Models with FAS II (40,000 lb) Rear Air Suspension	
R	01-09	<b>CLASSIC XL</b> All Models with FAS II (40,000 lb) Rear Air Suspension	
R	00-20	<b>COLUMBIA</b> All Models with FAS II (40,000 lb) Rear Air Suspension	
R	01-07	<b>CONDOR</b> All Models with FAS II (40,000 lb) Rear Air Suspension	
R	01-20	<b>CORONADO</b> All Models with FAS II (40,000 lb) Rear Air Suspension	
R	05-07	<b>FC70</b>	
R	99-04	<b>FC70</b> All Models with FAS II (40,000 lb) Rear Air Suspension	
R	99-07	<b>FC80</b> All Models with FAS II (40,000 lb) Rear Air Suspension	
R	91-06	<b>FL70</b> All Models with FAS II (40,000 lb) Rear Air Suspension	
R	91-06	<b>FL80</b> All Models with FAS II (40,000 lb) Rear Air Suspension	
R	89-99	<b>FLA086</b> All Models with FAS II (40,000 lb) Rear Air Suspension	
R	02	<b>FLB</b> All Models with FAS II (40,000 lb) Rear Air Suspension	
R	94-99	<b>FLB</b> All Models with FAS II (40,000 lb) Rear Air Suspension	
R	95-01	<b>FLC112</b> All Models with FAS II (40,000 lb) Rear Air Suspension	
R	95-08	<b>FLD112</b> All Models with FAS II (40,000 lb) Rear Air Suspension	
R	95-11	<b>FLD120</b> All Models with FAS II (40,000 lb) Rear Air Suspension	

## Numerical listing

Shock	POP	Alternative No.	MTG Acc. Supplied
Pos.	Year	Application	
85724	A (cont)		
R	05-12	<b>FLD120SD</b> All Models with FAS II (40,000 lb) Rear Air Suspension	
R	03	<b>FLD120SD</b> All Models with FAS II (40,000 lb) Rear Air Suspension	
R	03-11	<b>FLD132</b> All Models with FAS II (40,000 lb) Rear Air Suspension	
R	01	<b>FLD132</b> All Models with FAS II (40,000 lb) Rear Air Suspension	
R	05-21	<b>M2</b> All Models with FAS II (40,000 lb) Rear Air Suspension	
R	02-10	<b>M2 100</b> All Models with FAS II (40,000 lb) Rear Air Suspension	
R	05-06	<b>M2 106</b> All Models with FAS II (40,000 lb) Rear Air Suspension	
R	02-03	<b>M2 106</b> All Models with FAS II (40,000 lb) Rear Air Suspension	
R	03-24	<b>M2 112</b> All Models with FAS II (40,000 lb) Rear Air Suspension	
R	18-24	<b>VARIOUS</b>	
R		<b>RENEGADE VARIOUS</b>	
R	99-10	<b>STERLING TRUCK A9500</b> All Models with FAS II (40,000 lb) Rear Air Suspension	
R	99-01	<b>A9513</b> All Models with FAS II (40,000 lb) Rear Air Suspension	
R	99	<b>A9522</b> All Models with FAS II (40,000 lb) Rear Air Suspension	
R	10	<b>ACTERRA</b> All Models with FAS II (40,000 lb) Rear Air Suspension	
R	08	<b>ACTERRA</b> All Models with FAS II (40,000 lb) Rear Air Suspension	
R	03-06	<b>ACTERRA</b> All Models with FAS II (40,000 lb) Rear Air Suspension	
R	01-07	<b>ACTERRA 5500</b> All Models with FAS II (40,000 lb) Rear Air Suspension	
R	02-07	<b>ACTERRA 6500</b> All Models with FAS II (40,000 lb) Rear Air Suspension	
R	01-07	<b>ACTERRA 7500</b> All Models with FAS II (40,000 lb) Rear Air Suspension	
R	01-03	<b>ACTERRA 8500</b> All Models with FAS II (40,000 lb) Rear Air Suspension	
R	99-10	<b>L8500</b> All Models with FAS II (40,000 lb) Rear Air Suspension	
R	99	<b>L8501</b> All Models with FAS II (40,000 lb) Rear Air Suspension	
R	99-00	<b>L8511</b> All Models with FAS II (40,000 lb) Rear Air Suspension	
R	99-01	<b>L8513</b> All Models with FAS II (40,000 lb) Rear Air Suspension	
R	99-10	<b>L9500</b> All Models with FAS II (40,000 lb) Rear Air Suspension	
R	99-00	<b>L9501</b> All Models with FAS II (40,000 lb) Rear Air Suspension	
R	99-01	<b>L9511</b> All Models with FAS II (40,000 lb) Rear Air Suspension	
R	99-00	<b>L9513</b> All Models with FAS II (40,000 lb) Rear Air Suspension	
R	99	<b>L9522</b> All Models with FAS II (40,000 lb) Rear Air Suspension	
R	91-24	<b>THOMAS SAF-T-LINER</b> All Models 21K or 23K Airliner Rear Air Suspension	
R		<b>VARIOUS</b>	
R	19-24	<b>TIFFIN ALLEGRO BAY</b> All Models with Freightliner S2RV chassis	
R	22-24	<b>WESTERN STAR 47X</b> All Models with FAS II (40,000 lb) Rear Air Suspension	
R	21-24	<b>49X</b> All Models with FAS II (40,000 lb) Rear Air Suspension	
R	23-24	<b>57X</b> All Models with FAS II (40,000 lb) Rear Air Suspension	
R	12-22	<b>4700SB</b> All Models with FAS II (40,000 lb) Rear Air Suspension	
R	12-22	<b>4700SF</b> All Models with FAS II (40,000 lb) Rear Air Suspension	
R	16-22	<b>5700XE</b> All Models with Airliner Rear Air Suspension	
85727	W	145176 (2)	
R		<b>ABC BUS VARIOUS</b>	
R		<b>MOTOR COACH INDUSTRIES</b>	
R		<b>ADDITIONAL APPLICATIONS</b>	
R	06-09	<b>D4505</b> All (Trailing Axle)	
R	01-09	<b>D - SERIES COACHES</b>	
85728	D	145176 (2)	
F	01-09	<b>MOTOR COACH INDUSTRIES</b>	
F		<b>D4000</b>	
F	01-04	<b>D4005</b>	



## Numerical listing

Shock	POP	Alternative No.	MTG Acc. Supplied
Pos.	Year	Application	
85728	D (cont)		145176 (2)
F	05-09	D4005 All (Front Axle)	
F	01-09	D4500	
F	01-05	D4505	
F	06-09	D4505 All (Front Axle)	
F	01-09	DL3	
85729	D		145176(1)/401754(2)
R		<b>ABC BUS</b> VARIOUS	
R		<b>MOTOR COACH INDUSTRIES</b>	
		ADDITIONAL APPLICATIONS	
R	05-09	D4005 All (Drive Axle)	
R	06-09	D4505 All (Drive Axle)	
R	01-09	D - SERIES COACHES	
R		<b>ORION BUS</b> VARIOUS	
R		<b>UNIVERSAL COACH</b> VARIOUS	
85732	W		145116 (2)
F		<b>ABC BUS</b> VARIOUS	
F		<b>ORION BUS</b> VARIOUS	
85733	W		145089-000 (1)
R		<b>ABC BUS</b> VARIOUS	
R		<b>EAGLE MOTOR COACH</b> VARIOUS	
R	01-09	<b>MOTOR COACH INDUSTRIES D -</b>	
		<b>SERIES COACHES</b>	
R		<b>NOVA BUS CORPORATION</b>	
		VARIOUS	
R		<b>TRANSPORTATION MFG. CORP.</b>	
		VARIOUS	
85734	W		401754 (4)
R		<b>BLUE BIRD</b> MOTORHOMES	
R	89-04	TC2000 All Buses with Ridewell Rear Suspension with O.E.M. Number	
R	00-10	<b>COUNTRY COACH</b> AFFINITY All MotorHomes with Ridewell Rear Suspension	
R	00	<b>CONCEPT</b> All MotorHomes with Ridewell Rear Suspension	
R	00-04	<b>MAGNA</b> All MotorHomes with Ridewell Rear Suspension	
R	05-10	<b>MAGNA 630</b> All MotorHomes with Ridewell Rear Suspension	
F		<b>CROWN COACH</b> VARIOUS	
R		<b>GILLIG</b> VARIOUS	
R		<b>INTERNATIONAL F &amp; S</b> SERIES	
R		<b>FLEETSTAR - CONVENTIONAL</b>	
F		<b>OSHKOSH MOTOR TRUCK CO.</b>	
		VARIOUS	
R		<b>RIDEWELL CORP.</b> TRUCK AIR-RIDES	
R		<b>SAF HOLLAND</b> TRUCK & TRACTOR AIR SUSPENSION (TAG AXLE)	
85736	W		401754 (4)
F		<b>ACF BRILL BUS</b> VARIOUS	
F		<b>FLXIBLE TRANSIT BUS</b> VARIOUS	
R		VARIOUS	
R	89-03	<b>PREVOST</b> VARIOUS	
F		<b>THOMAS</b> VARIOUS	
85737	W		
R		<b>MERITOR</b> FS230 TRAILER SUSPENSION	
R		<b>SUSPENSYS</b> VARIOUS	
85738	A		
R		<b>EAST MANUFACTURING CORP.</b>	
		VARIOUS	
R		<b>HENDRICKSON TRAILER</b>	
		<b>SUSPENSION SYSTEMS</b> INTRAAX	
R		TOP MOUNT STYLE	
R		UNDERSLUNG STYLE	
R		VANTRAX	
R		<b>MC NEILUS TRUCK &amp; MAN.</b>	
		VARIOUS	
R		<b>REYCO</b> SUSPENSION TRAILER	
R		<b>TUTHILL TECHNOLOGIIES</b>	
		TRAILER	
R		<b>UTILITY TRAILER</b>	
		<b>MANUFACTURING COMPANY</b>	
		FLATBEDS	
85739	W		
R		<b>INTERNATIONAL</b> VARIOUS	
R		<b>MACK</b> ADDITIONAL APPLICATIONS	
R		<b>MERITOR</b> VARIOUS	
R		<b>RAYDAN</b> MANUFACTURING VARIOUS	
85740	W		145090(1)/401754(2)
F		<b>KENWORTH</b> K100, K100E, K125	

## 85000 Series

Shock	POP	Alternative No.	MTG Acc. Supplied
Pos.	Year	Application	
85740	W (cont)		145090(1)/401754(2)
R	01-03	<b>MOTOR COACH INDUSTRIES G -</b>	
		<b>SERIES COACHES</b>	
85900	B		145054 (2)
F	06	<b>COACHMEN</b> CROSS COUNTRY	
F	03-05	<b>CROSS COUNTRY ELITE</b>	
F	03-05	<b>CROSS COUNTRY SE</b>	
F	02-06	<b>FLEETWOOD</b> BOUNDER All Models with Freightliner XC Chassis with ZF - IFS Front Suspension and 23,000 lb GVW or Greater	
F	02-06	<b>DISCOVERY</b> All Models with Freightliner XC Chassis with ZF - IFS Front Suspension and 23,000 lb GVW or Greater	
F	03-06	<b>EXCURSION</b> All Models with Freightliner XC Chassis with ZF - IFS Front Suspension and 23,000 lb GVW or Greater	
F	02-06	<b>EXPEDITION</b> All Models with Freightliner XC Chassis with ZF - IFS Front Suspension and 23,000 lb GVW or Greater	
F	04-06	<b>PROVIDENCE</b> All Models with Freightliner XC Chassis with ZF - IFS Front Suspension and 23,000 lb GVW or Greater	
F	02-04	<b>FOREST RIVER</b> REFLECTION	
F	02-06	<b>TSUNAMI</b>	
F	03-07	<b>FREIGHTLINER</b> VC CHASSIS	
F		XC CHASSIS	
F	03-07	<b>XC CHASSIS</b>	
F	03-06	<b>GULF STREAM</b> ATRIUM	
F	02-06	<b>FRIENDSHIP</b>	
F	02-06	<b>SCENIC</b> CRUISER	
F	02-06	<b>ITASCA</b> CLASS A MOTORHOMES	
R		<b>KENWORTH</b> C500, C500B, C500K, C540 & C550	
R		K100, K100E, K125	
R	93-05	<b>K300</b> All All with Air Glide 200 with 40,000 lb Suspension with 8 air bags, 4 units required	
R		T300	
R		T400, T400B, T450B	
R		T600, T600A, T600B, T602	
R		T800, T800B, T800B(8X4), T800SH, T800H, T800W	
R	97-11	<b>T2000</b> All All with Air Glide 200 with 40,000 lb Suspension with 8 air bags, 4 units required	
R		W900, W900B, W900L, W900S	
R	04-06	<b>KING OF THE ROAD</b> CLASS A MOTORHOMES	
F	04-06	<b>MANDALAY COACH</b> CLASS A MOTORHOMES	
F	02-06	<b>NEWMAR</b> CLASS A MOTORHOMES	
F	02-06	<b>THOR MOTOR COACH</b> CLASS A MOTORHOMES	
85901	D		401754 (4)
F	97-99	<b>FREIGHTLINER</b> CENTURY CLASS All Models with 12000 lb Taperleaf Front Suspension	
F		<b>RIDEWELL CORP.</b> TRUCK AIR-RIDES	
85902	W		145054 (2)
R	95-11	<b>KENWORTH</b> C500 All All with Air Glide 200 with 46,000 lb Suspension with 8 air bags, 4 units required	
R		C500, C500B, C500K, C540 & C550	
R		K100, K100E, K125	
R	93-05	<b>K300</b> All All with Air Glide 200 with 46,000 lb Suspension with 8 air bags, 4 units required	
R	01-08	<b>T300</b> All All with Air Glide 200 with 46,000 lb Suspension with 8 air bags, 4 units required	
R	95-99	<b>T300</b> All All with Air Glide 200 with 46,000 lb Suspension with 8 air bags, 4 units required	
R	10-11	<b>T400</b> All All with Air Glide 200 with 46,000 lb Suspension with 8 air bags, 4 units required	
R	95-99	<b>T400</b> All All with Air Glide 200 with 46,000 lb Suspension with 8 air bags, 4 units required	
R		T400, T400B, T450B	
R	95-97	<b>T450</b> All All with Air Glide 200 with 46,000 lb Suspension with 8 air bags, 4 units required	
R		T600, T600A, T600B, T602	

## Numerical listing

Shock	POP	Alternative No.	MTG Acc. Supplied
Pos.	Year	Application	
85902	W (cont)		145054 (2)
R	95-08	<b>T600A</b> All All with Air Glide 200 with 46,000 lb Suspension with 8 air bags, 4 units required	
R	95-11	<b>T800</b> All All with Air Glide 200 with 46,000 lb Suspension with 8 air bags, 4 units required	
R		<b>T800, T800B, T800B(8X4), T800SH, T800H, T800W</b>	
R	97-11	<b>T2000</b> All All with Air Glide 200 with 46,000 lb Suspension with 8 air bags, 4 units required	
R	95-11	<b>W900</b> All All with Air Glide 200 with 46,000 lb Suspension with 8 air bags, 4 units required	
R		W900, W900B, W900L, W900S	
85906	D		
R	96-98	<b>FORD</b> A9513 All All with Neway AD-246 Air Suspension	
R	97	<b>A9522</b> All All with Neway AD-246 Air Suspension	
R	96-98	<b>AT9513</b> All All with Neway AD-246 Air Suspension	
R	97-98	<b>AT9522</b> All All with Neway AD-246 Air Suspension	
R		<b>LOUISVILLE SERIES -</b>	
		<b>CONVENTIONAL CAB</b>	
R	12-16	<b>KENWORTH</b> T440	
R	10-16	<b>T470</b>	
R		<b>MACK</b> ADDITIONAL APPLICATIONS	
R	89-05	<b>CH</b> All CH600 Models with Neway AD Air Suspension Shock w/ extended length of 21.70"	
R	91-07	<b>CL</b> All CL600, CL700 Models with Neway AD Air Suspension Shock w/ extended length of 21.70"	
R	98-05	<b>CX</b> All Models with Neway AD Air Suspension Shock w/ extended length of 21.70"	
R		<b>MC NEILUS TRUCK &amp; MAN.</b>	
		VARIOUS	
R		<b>SAF HOLLAND</b> TRAILER AIR SUSPENSION	
R		<b>TRUCK, BUS &amp; MOTORHOME</b> AIR SUSPENSIONS	
R	06	<b>VOLVO</b> VHD All All with Neway AD-246 Air Suspension	
R		<b>WESTERN STAR</b> 4800 & 4900 SERIES	
		5900 & 6900 SERIES	
85908	W		
F	24	<b>AUTOCAR</b> LLC. DC-64	
F	20-23	<b>DC-64</b> All Models with 20,000 lb Front Axle	
R		<b>SAF HOLLAND</b> TRAILER AIR SUSPENSION	
R		<b>TRUCK, BUS &amp; MOTORHOME</b> AIR SUSPENSIONS	
85909	D		
R		<b>FORD</b> LOUISVILLE SERIES - CONVENTIONAL CAB	
R		<b>HENDRICKSON TRUCK</b>	
		<b>SUSPENSION SYSTEMS</b> HAS - SERIES	
R	12-16	<b>KENWORTH</b> T440	
R	10-16	<b>T470</b>	
R		<b>T800, T800B, T800B(8X4), T800SH, T800H, T800W</b>	
R	10	<b>W900, W900B, W900L, W900S</b>	
R	89-05	<b>MACK</b> CH All CH600 Models with Neway AD Air Suspension Shock w/ extended length of 24.30"	
R	91-07	<b>CL</b> All CL600, CL700 Models with Neway AD Air Suspension Shock w/ extended length of 24.30"	
R	98-05	<b>CX</b> All Models with Neway AD Air Suspension Shock w/ extended length of 24.30"	
R		<b>MC NEILUS TRUCK &amp; MAN.</b>	
		VARIOUS	
R		<b>NEWMAR</b> CLASS A MOTORHOMES	
R		<b>PETERBILT</b> 320	
R	17-19	<b>520</b> All Models with Neway AD-252-10 Tandem Axle	
R		<b>ROADMASTER (MONACO)</b>	
		VARIOUS	
R		<b>SAF HOLLAND</b> TRUCK, BUS & MOTORHOME AIR SUSPENSIONS	
F	97-00	<b>SPARTAN MOTORS</b> HIGHLANDER All With I Beam Front Suspension	

## Numerical listing

Shock	POP	Alternative No.	MTG Acc. Supplied
Pos.	Year	Application	
<b>85909</b>	D	(cont)	
F	95-96	K2	
F	97-00	K2 All With I Beam Front Suspension	
F	95-00	MOUNTAIN MASTER All With I Beam Front Suspension	
<b>85910</b>	W		
R		<b>BLUE BIRD</b> ADDITIONAL APPLICATIONS	
R		<b>FREIGHTLINER</b> VARIOUS	
F		<b>PETERBILT 330</b>	
R		<b>ROADMASTER (MONACO)</b> VARIOUS	
R		<b>SAF HOLLAND</b> TRAILER AIR SUSPENSION	
R		TRUCK, BUS & MOTORHOME AIR SUSPENSIONS	
F	93-00	<b>SAFARI MOTOR COACH</b> CLASS A MOTORHOMES	
F	00-12	<b>SPARTAN MOTORS</b> CLASS A MOTORHOMES	
<b>85911</b>	D		
R		<b>HENDRICKSON TRAILER SUSPENSION SYSTEMS</b> INTRAAX TOP MOUNT STYLE	
R		<b>SAF HOLLAND</b> TRAILER AIR SUSPENSION	
R		TRUCK, BUS & MOTORHOME AIR SUSPENSIONS	
R		<b>UTILITY TRAILER MANUFACTURING COMPANY</b> FLATBEDS	
<b>85916</b>	W		
R		<b>GILLIG</b> VARIOUS	
R		<b>HENDRICKSON TRAILER SUSPENSION SYSTEMS</b> INTRAAX VANTRAAX	
R		<b>MC NEILUS TRUCK &amp; MAN.</b> VARIOUS	
R		<b>SAF HOLLAND</b> TRAILER AIR SUSPENSION	
R		TRUCK, BUS & MOTORHOME AIR SUSPENSIONS	
R		TRUCK & TRACTOR AIR SUSPENSION (TAG AXLE)	
<b>85918</b>	A		
F	02-04	<b>DYNAMAX CORP</b> GRAND SPORT All Models with 12000 lb Taperleaf Front Suspension	
F	07-08	GRAND SPORT GT TOY HAULER All 410TH & 450TH Models with 12000 lb Taperleaf Front Suspension	
F	07-08	GRAND SPORT ULTRA All Models with 14,000 lb Taperleaf Front Suspension	
F	20-24	<b>ENTEGRA COACH</b> ACCOLADE All Models with Freightliner S2RV chassis	
F	21-24	ACCOLADE XL All Models with Freightliner S2RV chassis	
F	12-23	<b>FREIGHTLINER 114SD</b> All All Models with 18,000 lb Flat Leaf Spring	
F	99-15	<b>ARGOSY</b> All Models with 12000 lb Taperleaf Front Suspension	
F	05-23	B2 All Models with 12000 lb Taperleaf Front Suspension	
F	08	<b>CASCADIA</b> All 125 Models with 12000 to 13300 lb Taperleaf Front Suspension	
F		CENTURY CLASS	
F	00-11	CENTURY CLASS All Models with 12000 lb Taperleaf Front Suspension	
F	01-11	CLASSIC All Models with 12000 lb Taperleaf Front Suspension	
F	01-09	CLASSIC XL All Models with 12000 lb Taperleaf Front Suspension	
F	00-08	<b>COLUMBIA</b> All Models with 12000 lb Taperleaf Front Suspension	
F	01-07	CONDOR All Models with 14,600 to 20,000 lb Front Suspension	
F	01-09	CORONADO All Models with 12000 lb Taperleaf Front Suspension	
F	95-01	FLC112 All Models with 12000 lb Taperleaf Front Suspension	
F	95-08	FLD112 All Models with 12000 lb Taperleaf Front Suspension	
F	95-08	FLD120 All Models with 12000 lb Taperleaf Front Suspension	
F	05-08	FLD120SD All Models with 12000 lb Taperleaf Front Suspension	

## 85000 Series

Shock	POP	Alternative No.	MTG Acc. Supplied
Pos.	Year	Application	
<b>85918</b>	A	(cont)	
F	03	FLD120SD All Models with 12000 lb Taperleaf Front Suspension	
F	05-08	FLD132 All Models with 12000 lb Taperleaf Front Suspension	
F	06-08	FRED CHASSIS	
F	03-08	M2 112 All Models with 12000 lb to 20000 Front Axle	
F		MC CHASSIS	
F	18-24	VARIOUS	
F	99-03	<b>STERLING TRUCK</b> A9500 All Models with 12000 lb Taperleaf Front Suspension	
F	99-01	A9513 All Models with 12000 lb Taperleaf Front Suspension	
F	99	A9522 All Models with 12000 lb Taperleaf Front Suspension	
F	95-23	<b>THOMAS</b> SAF-T-LINER All Models with 12000 lb Taperleaf Front Suspension	
F	95-23	SAF-T-LINER All Models with Freightliner CC B2 Bus Chassis	
F	19-24	<b>TIFFIN ALLEGRO BAY</b> All Models with Freightliner S2RV chassis	
F	12-20	<b>WESTERN STAR 4700SF</b> All Models with 18,000 lb - 20,000 lb Flat Leaf Spring	
<b>85919</b>	A		
F	98-15	<b>BLUE BIRD</b> ALL AMERICAN FE All Buses with Hendrickson Parasteer Suspensions	
F	98-15	ALL AMERICAN RE All Buses with Hendrickson Parasteer Suspensions	
R		<b>FREIGHTLINER MB CHASSIS</b>	
R		<b>GREAT DANE TRAILER</b> VARIOUS	
F		<b>HENDRICKSON TRUCK SUSPENSION SYSTEMS</b> ADDITIONAL APPLICATIONS	
F		<b>MC NEILUS TRUCK &amp; MAN.</b> VARIOUS	
R	97-21	<b>MERITOR RHP</b> TRAILER SUSPENSION	
R	97-21	<b>WABASH NATIONAL</b> VARIOUS	
R		<b>WORKHORSE</b> VARIOUS	
<b>85920</b>	B		
F	05-07	<b>DYNAMAX CORP</b> DYNAQUEST All Models with 10000 to 12000 lb. Taper-leaf Spring Suspension	
F	07-08	GRAND SPORT GT TOY HAULER All 390TH Models with 12000 lb Taperleaf Front Suspension	
F	03-07	GRAND SPORT M2 All Models with 10000 to 12000 lb. Taper-leaf Spring Suspension	
F	02-08	<b>FEDERAL COACH</b> VARIOUS	
F	05-06	<b>FREIGHTLINER M2 106</b> All Models with 10000 to 12000 lb. Taper-leaf Spring Suspension	
F	05-06	M2 106 All Models with 6000 to 9000 lb Front axle	
F	02-03	M2 106 All Models with 10000 to 12000 lb. Taper-leaf Spring Suspension	
F	02-03	M2 106 All Models with 6000 to 9000 lb Front axle	
F	01-09	<b>STERLING TRUCK</b> ACTERRA	
<b>85921</b>	W	145054 (1)	
R	05-21	<b>FREIGHTLINER M2</b> All Models with Rear 60" Spring ,18000 lb - 23000 lb	
R	02-10	M2 100 All Models with Rear 60" Spring ,18000 lb - 23000 lb	
R	05-06	M2 106 All Models with Rear 60" Spring ,18000 lb - 23000 lb	
R	02-03	M2 106 All Models with Rear 60" Spring ,18000 lb - 23000 lb	
R	03-23	M2 112 All Models with Rear 60" Spring ,18000 lb - 23000 lb	
<b>85923</b>	D		
R	08-09	<b>INTERNATIONAL 4400</b> All Models with International 40,000 lb Rear Air Suspension	
R	02-07	8500 All Models with International 40,000 lb Rear Air Suspension	
R	08-09	8500 TRANSTAR All Models with International 40,000 lb Rear Air Suspension	
R	08-09	8600 TRANSTAR All Models with International 40,000 lb Rear Air Suspension	
R		<b>DURASTAR - 4300, 4400 SERIES</b>	
R	10-11	<b>DURASTAR - 4300, 4400 SERIES</b>	

## Numerical listing

Shock	POP	Alternative No.	MTG Acc. Supplied
Pos.	Year	Application	
<b>85923</b>	D	(cont)	
R	12-16	<b>LONESTAR</b> All Models with International 40,000 lb Rear Air Suspension (52" Spacing- Heavy Duty Rear)	
R		<b>PAYSTAR - 5000 SERIES</b> SERIES 9900, 9900I, 9900IX LONG HOOD CONV. TRUCK	
R	10-18	TRANSTAR - 8500, 8600 SERIES	
R		TRANSTAR - 8500, 8600 SERIES	
R		WORKSTAR - 7000 SERIES	
<b>85924</b>	D		
F		<b>INTERNATIONAL 9100I</b> 9200I	
F	00-09	9200I SBA All Models with 12,000 lb Front Axle	
F	00	9200 SBA All Models with 12,000 lb Front Axle	
F	00	9300 All Models with 12,000 lb Front Axle	
F	00	9400 All Models with 12,000 lb Front Axle	
F	00-09	9400I SBA All Models with 12,000 lb Front Axle	
F	04-09	9900I All Models with 12,000 lb Front Axle	
F	04-09	9900IX All Models with 12,000 lb Front Axle	
F		SERIES 9200, 9200I - TRACTOR & STRAIGHT TRUCK	
F		SERIES 9900, 9900I, 9900IX LONG HOOD CONV. TRUCK	
F	19-21	WORKSTAR - 7000 SERIES	
<b>85927</b>	W		
R	14	<b>FORD</b> F-650	
R	15	F-650 All Models with International Air Suspension (4x2)	
R	04-13	F-650 All Models with International Air Suspension (4x2)	
R	14	F-750	
R	15	F-750 All Models with International Air Suspension (4x2)	
R	04-13	F-750 All Models with International Air Suspension (4x2)	
R		<b>INTERNATIONAL</b> VARIOUS	
F	10-17	<b>MACK</b> TD700 All TD-713 Models with 20,000 lb Front Axle	
F	10-17	TITAN All Models with 20,000 lb Front Axle	
<b>85928</b>	C		
F	14	<b>FORD</b> F-650	
F	15	F-650 All Models with 12,000 & 13,200 lb Front Springs	
F	00-13	F-650 All Models with 12,000 & 13,200 lb Front Springs	
F	14	F-750	
F	15	F-750 All Models with 12,000 & 13,200 lb Front Springs	
F	00-13	F-750 All Models with 12,000 & 13,200 lb Front Springs	
F	00-15	<b>GLAVAL BUS CO.</b> CONCORDE II - SERIES	
F	16-20	<b>INTERNATIONAL</b> DURASTAR - 4300, 4400 SERIES	
F	23	EMV607	
F	19-23	HV607 All Models with 11,000 lb to 14,000 lb Taper-leaf Springs	
F	23-24	MV607 All Models with 11,000 lb to 14,000 lb Taper-leaf Springs	
F	15-20	WORKSTAR 7300 All Models with 11,000 lb to 14,000 lb Front axle	
F	15-20	WORKSTAR 7400 All Models with 11,000 lb to 14,000 lb Front axle	
F	15-22	WORKSTAR 7600 All Models with 11,000 lb to 14,000 lb Front axle	
F	19-23	<b>PIERCE MFG. INC.</b> VARIOUS	
F	00-15	<b>STARCRAFT BUS CO.</b> ALLSTAR XL & XLT - SERIES	
<b>85929</b>	W		
F		<b>INTERNATIONAL 7400</b>	
F		<b>PAYSTAR - 5000 SERIES</b>	
F		VARIOUS	
F		WORKSTAR - 7000 SERIES	
<b>85931</b>	A		
R	04-09	<b>INTERNATIONAL 9200I SBA</b> All All models with 40,000 lb Rear Air Suspension	
R	04-09	9400I SBA All All models with 40,000 lb Rear Air Suspension	

## Numerical listing

Shock	POP	Alternative No.	MTG Acc. Supplied
Pos.	Year	Application	
<b>85931</b>	A (cont)		
R	04-09	9900I	All All models with 40,000 lb Rear Air Suspension
R	04-09	9900IX	All All models with 40,000 lb Rear Air Suspension
R	09-15	LONESTAR	All All models with 40,000 lb Rear Air Suspension
R		LONESTAR - SERIES	
R		PROSTAR	
R	09-17	PROSTAR	All All models with 40,000 lb Rear Air Suspension
R		SERIES 9200, 9200I - TRACTOR & STRAIGHT TRUCK	
R		SERIES 9300, 9300I, 9400 & 9400I	
R	10-11	SERIES 9900, 9900I, 9900IX	LONG HOOD CONV. TRUCK
R		TERRASTAR	
<b>85932</b>	C		
F	09-22	<b>FREIGHTLINER CASCADIA</b>	All Models with Hendrickson Front Airtek
F	00-11	<b>CENTURY CLASS</b>	All Models with Hendrickson Front Airtek
F	01-11	<b>CLASSIC</b>	All Models with Hendrickson Front Airtek
F	01-09	<b>CLASSIC XL</b>	All Models with Hendrickson Front Airtek
F	00-20	<b>COLUMBIA</b>	All Models with Hendrickson Front Airtek
F	01-20	<b>CORONADO</b>	All Models with Hendrickson Front Airtek
F	02-08	<b>FLD112</b>	All Models with Hendrickson Front Airtek
F	02-11	<b>FLD120</b>	All Models with Hendrickson Front Airtek
F	05-12	<b>FLD120SD</b>	All Models with Hendrickson Front Airtek
F	03	<b>FLD120SD</b>	All Models with Hendrickson Front Airtek
F	03-11	<b>FLD132</b>	All Models with Hendrickson Front Airtek
F		<b>HENDRICKSON TRUCK SUSPENSION SYSTEMS</b>	AIRTEK - SERIES
F		<b>MC NEILUS TRUCK &amp; MAN.</b>	VARIOUS
F	10	<b>STERLING TRUCK ACTERRA</b>	All Models with Hendrickson Front Airtek
F	08	<b>ACTERRA</b>	All Models with Hendrickson Front Airtek
F	03-06	<b>ACTERRA</b>	All Models with Hendrickson Front Airtek
F	01-07	<b>ACTERRA 5500</b>	All Models with Hendrickson Front Airtek
F	02-07	<b>ACTERRA 6500</b>	All Models with Hendrickson Front Airtek
F	01-07	<b>ACTERRA 7500</b>	All Models with Hendrickson Front Airtek
F	01-03	<b>ACTERRA 8500</b>	All Models with Hendrickson Front Airtek
F	00-02	<b>WESTERN STAR 4800</b>	All Models with Hendrickson Front Airtek
F	12-22	<b>4800SB</b>	All Models with Hendrickson Front Airtek
F	13-22	<b>4800SF</b>	All Models with Hendrickson Front Airtek
F	00-02	<b>4900E</b>	All Models with Hendrickson Front Airtek
F	02-22	<b>4900EX</b>	All Models with Hendrickson Front Airtek
F	02-22	<b>4900FA</b>	All Models with Hendrickson Front Airtek
F	02-22	<b>4900SA</b>	All Models with Hendrickson Front Airtek
F	16-22	<b>5700XE</b>	All Models with Hendrickson Front Airtek
F	00-01	<b>5900</b>	All Models with Hendrickson Front Airtek
F	00-01	<b>6900</b>	All Models with Hendrickson Front Airtek
F	22	<b>6900XD</b>	All Models with Hendrickson Front Airtek
F	18-19	<b>6900XD</b>	All Models with Hendrickson Front Airtek
F	02-16	<b>6900XD</b>	All Models with Hendrickson Front Airtek
<b>85933</b>	D		
F		<b>HENDRICKSON TRUCK SUSPENSION SYSTEMS</b>	AIRTEK - SERIES

## 85000 Series

Shock	POP	Alternative No.	MTG Acc. Supplied
Pos.	Year	Application	
<b>85933</b>	D (cont)		
F		<b>MACK ADDITIONAL APPLICATIONS</b>	
F	04-08	CXN All CXN-613 Models with Hendrickson AirTek Front Air Suspension	
F		<b>MC NEILUS TRUCK &amp; MAN.</b>	VARIOUS
F	06-19	<b>POWERHOUSE COACH INC.</b>	VARIOUS
F		<b>VOLVO ADDITIONAL APPLICATIONS</b>	
F	05-19	VNL All Models with Hendrickson Airtek	
F	06-14	VNL 300	
F	16-19	VNL 300 All Models with Hendrickson Airtek	
F	05-14	VNL 430	
F	17-18	VNL 630	
F	06-14	VNL 630	
F	15-16	VNL 630 All Models with Hendrickson Airtek	
F	17-18	VNL 670	
F	06-14	VNL 670	
F	15-16	VNL 670 All Models with Hendrickson Airtek	
F	17-19	VNL 740 All Models with Hendrickson Airtek	
F	17-19	VNL 760 All Models with Hendrickson Airtek	
F	06-16	VNL SERIES	
F	18-19	VNR All Models with Hendrickson Airtek	
<b>85934</b>	A		
R		<b>RIDEWELL CORP. TRAILER AIRRIDES</b>	
R		<b>WATSON &amp; CHALIN MFG. INC.</b>	VARIOUS
<b>85935</b>	W 145090 (1)		
R		<b>INTERNATIONAL SERIES 8000 - CONVENTIONAL HEAVY DUTY TRACTOR</b>	
<b>85936</b>	B 145089-200 (1)		
R	16-17	<b>KENWORTH ICON 900</b>	
R	12-19	T440	
R	10-17	T470	
R	01-07	T600, T600B, T602	
R	01-08	T600A All Models with Air Glide 400 (AG400) Rear Air Suspension	
R	13-18	T660 All Models with Air Glide 400 (AG400) Rear Air Suspension	
R	13-24	T680 All Models with Air Glide 400 (AG400) Rear Air Suspension	
R	11-16	T700 All Models with Air Glide 400 (AG400) Rear Air Suspension	
R	01-23	T800 All Models with Air Glide 400 (AG400) Rear Air Suspension	
R	10-21	T800, T800B, T800B(8X4), T800SH, T800H, T800W	
R	07-09	T800B, T800B(8X4), T800SH, T800H, T800W	
R	11-24	T880 All Models with Air Glide 400 (AG400) Rear Air Suspension	
R	05-11	T2000 All Models with Air Glide 400 (AG400) Rear Air Suspension	
R	04-24	W900 All Models with Air Glide 400 (AG400) Rear Air Suspension	
R	05-21	W900, W900B, W900L, W900S	
R	19-24	W990 All Models with Air Glide 400 (AG400) Rear Air Suspension	
<b>85937</b>	B 145089-200 (1)		
R	16-17	<b>KENWORTH ICON 900</b>	
R	12-20	T440	
R	10-19	T470	
R	05-08	T600A All Models with Air Glide 460 (AG460) Rear Air Suspension	
R	07-20	T660 All Models with Air Glide 460 (AG460) Rear Air Suspension	
R	11-23	T680 All Models with Air Glide 460 (AG460) Rear Air Suspension	
R	05-23	T800 All Models with Air Glide 460 (AG460) Rear Air Suspension	
R	11-24	T880 All Models with Air Glide 460 (AG460) Rear Air Suspension	
R	05-11	T2000 All Models with Air Glide 460 (AG460) Rear Air Suspension	
R	05-24	W900 All Models with Air Glide 460 (AG460) Rear Air Suspension	
R	19-24	W990 All Models with Air Glide 460 (AG460) Rear Air Suspension	

## Numerical listing

Shock	POP	Alternative No.	MTG Acc. Supplied
Pos.	Year	Application	
<b>85938</b>	B		
R		<b>HENDRICKSON TRAILER SUSPENSION SYSTEMS</b>	UNDERSLUNG STYLE
R		<b>INGERSOLL AXLES</b>	VARIOUS
R		<b>REYCO SUSPENSION TRAILER</b>	TUTHILL TECHNOLOGIES
R		<b>WATSON &amp; CHALIN MFG. INC.</b>	VARIOUS
<b>85939</b>	C		
R		<b>HENDRICKSON TRAILER SUSPENSION SYSTEMS</b>	INTRAAAX TOP MOUNT STYLE
R		<b>TIMBREN INDUSTRIES</b>	VARIOUS
R		<b>UTILITY TRAILER MANUFACTURING COMPANY</b>	FLATBEDS
R		<b>WATSON &amp; CHALIN MFG. INC.</b>	VARIOUS
<b>85954</b>	A		
F	07-08	<b>INTERNATIONAL PROSTAR</b>	SERIES 8000 - CONVENTIONAL HEAVY DUTY TRACTOR
F		<b>TRANSTAR</b>	8500, 8600 SERIES
<b>85955</b>	W		
F		<b>HENDRICKSON TRUCK SUSPENSION SYSTEMS</b>	AIRTEK - SERIES
F	07-11	<b>INTERNATIONAL 9200I SBA</b>	All Models with Day Cab & Hendrickson AirTek Suspension
F	07-11	<b>9200I SBA</b>	All Models with Sleeper Cab & Hendrickson AirTek Suspension
F	07-11	<b>9400I SBA</b>	All Models with Day Cab & Hendrickson AirTek Suspension
F	07-11	<b>9400I SBA</b>	All Models with Sleeper Cab & Hendrickson AirTek Suspension
<b>85956</b>	C		
R	12-24	<b>FREIGHTLINER 108SD</b>	All Models with Freightliner TuffTrac Rear Air Suspension
R	12-24	<b>114SD</b>	All Models with Freightliner TuffTrac Rear Air Suspension
R	13-23	<b>122SD</b>	All Models with Freightliner TuffTrac Rear Air Suspension
R	00-20	<b>COLUMBIA</b>	All All Models with Freightliner TuffTrac Rear Air Suspension
R	01-07	<b>CONDOR</b>	All Models with Freightliner TuffTrac Rear Air Suspension
R	01-20	<b>CORONADO</b>	All Models with Freightliner TuffTrac Rear Air Suspension
R	08	<b>FLD112</b>	All All Models with Freightliner TuffTrac Rear Air Suspension
R	08-11	<b>FLD120</b>	All All Models with Freightliner TuffTrac Rear Air Suspension
R	08-12	<b>FLD120SD</b>	All All Models with Freightliner TuffTrac Rear Air Suspension
R	08-11	<b>FLD132</b>	All All Models with Freightliner TuffTrac Rear Air Suspension
R	05-21	<b>M2</b>	All Models with Freightliner TuffTrac Rear Air Suspension
R	02-10	<b>M2 100</b>	All Models with Freightliner TuffTrac Rear Air Suspension
R	05-06	<b>M2 106</b>	All Models with Freightliner TuffTrac Rear Air Suspension
R	02-03	<b>M2 106</b>	All Models with Freightliner TuffTrac Rear Air Suspension
R	03-24	<b>M2 112</b>	All Models with Freightliner TuffTrac Rear Air Suspension
R	10	<b>STERLING TRUCK ACTERRA</b>	All All Models with Freightliner TuffTrac Rear Air Suspension
R	08	<b>ACTERRA</b>	All All Models with Freightliner TuffTrac Rear Air Suspension
R	03-06	<b>ACTERRA</b>	All All Models with Freightliner TuffTrac Rear Air Suspension
R	22-24	<b>WESTERN STAR 47X</b>	All Models with Freightliner TuffTrac Rear Air Suspension



## Numerical listing

Shock	POP	Alternative No.	MTG Acc. Supplied
Pos.	Year	Application	
<b>85956</b> C (cont)			
R	21-24	49X	All Models with Freightliner TufTrac Rear Air Suspension
R	12-23	4700SB	All Models with Freightliner TufTrac Rear Air Suspension
R	12-23	4700SF	All Models with Freightliner TufTrac Rear Air Suspension
R	12-22	4800SB	All Models with Freightliner TufTrac Rear Air Suspension
R	13-22	4800SF	All Models with Freightliner TufTrac Rear Air Suspension
R	08-22	4900EX	All Models with Freightliner TufTrac Rear Air Suspension
R	08-23	4900FA	All Models with Freightliner TufTrac Rear Air Suspension
R	08-23	4900SA	All Models with Freightliner TufTrac Rear Air Suspension
R	22	6900XD	All Models with Freightliner TufTrac Rear Air Suspension
R	18-19	6900XD	All Models with Freightliner TufTrac Rear Air Suspension
R	08-16	6900XD	All Models with Freightliner TufTrac Rear Air Suspension
<b>85957</b> D			
F	15	<b>INTERNATIONAL</b>	4300 All Models with 12,000 lb Front axle
F	02-15	4400	All Models with 12,000 lb Front axle
F	02-16	7300	All Models with 12,000 lb Front axle
F	02-16	7400	All Models with 12,000 lb Front axle
F	02-16	7500	All Models with 12,000 lb Front axle
F	08	7600	
F	09-16	7600	All Models with 12,000 lb Front axle
F	03-07	7600	All Models with 12,000 lb Front axle
F	02-07	8500	All Models with 10,000 to 14,000 lb Front axle
F	08-11	8500	TRANSTAR All Models with 10,000 to 14,000 lb Front axle
F	08-11	8600	TRANSTAR All Models with 10,000 to 14,000 lb Front axle
F	10-15	DURASTAR - 4300, 4400	SERIES
F	19-20	HV607	All Models with 16,000 lb to 23,000 lb Parabolic Taperleaf Springs
F	19-20	HV613	All Models with 16,000 lb to 23,000 lb Parabolic Taperleaf Springs
F		SERIES 3000 - SCHOOL BUS	CHASSIS
F	10-15	TRANSTAR - 8500, 8600	SERIES
F	15-20	WORKSTAR 7300	All Models with 12,000 lb Front axle
F	15-20	WORKSTAR 7400	All Models with 12,000 lb Front axle
F	08-20	WORKSTAR 7600	All Models with 12,000 lb Front axle
F	10	WORKSTAR - 7000	SERIES
F	19-21	<b>PIERCE MFG. INC.</b>	VARIOUS
<b>85958</b> A			
F	09-24	<b>DYNAMAX CORP</b>	DYNAQUEST XL All Models with 12000 lb to 20000 Front Axle
F	09-14	GRAND SPORT GT	All Models with 14,600 lb Taperleaf Front Suspension
F	09-13	GRAND SPORT GT TOY HAULER	All 410TH & 450TH Models with 12000 lb Taperleaf Front Suspension
F	09-14	GRAND SPORT ULTRA	All Models with 14,000 lb Taperleaf Front Suspension
F	12-24	<b>FREIGHTLINER</b>	114SD All All Models with 12000 lb to 20000 lb Set-Back Front Axle
F	13-23	122SD	All All Models with 12000 lb to 20000 lb Set-Back Front Axle
F	09-20	CASCADIA	All 125 Models with 12000 to 13300 lb Taperleaf Front Suspension
F	09-17	CASCADIA	All 113 Models with 12000 to 13300 lb Taperleaf Front Suspension
F	09-20	COLUMBIA	All Models with 12000 lb Taperleaf Front Suspension
F	10-20	CORONADO	All Models with 12,000 lb to 20,000 Front Axle
F	09-11	FLD120	All Models with 12000 to 13300 lb Taperleaf Front Suspension

## 85000 Series

Shock	POP	Alternative No.	MTG Acc. Supplied
Pos.	Year	Application	
<b>85958</b> A (cont)			
F	09-12	FLD120SD	All Models with 12000 to 13300 lb Taperleaf Front Suspension
F	09-11	FLD132	All Models with 12000 to 13300 lb Taperleaf Front Suspension
F	09-24	M2 112	All Models with 12000 lb to 20000 Front Axle
F	09-24	<b>PIERCE MFG. INC.</b>	VARIOUS
F	09-19	<b>RENEGADE</b>	VARIOUS
F	12-20	<b>WESTERN STAR</b>	4700SB All Models with 20000 lb Set -Back Front Axle
F	12-20	4800SB	All Models with 12000 lb Taperleaf Front Suspension
F	13-20	4800SF	All Models with 12000 lb Taperleaf Front Suspension
F	08-20	4900EX	All Models with 12000 lb Taperleaf Front Suspension
F	08-20	4900FA	All Models with 12000 lb Taperleaf Front Suspension
F	08-20	4900SA	All Models with 20000 lb Set -Back Front Axle
F	16-22	5700XE	All Models with 12,000 lb to 14,600 lb Taperleaf Springs
F	18-19	6900XD	All Models with 12000 lb Taperleaf Front Suspension
F	09-16	6900XD	All Models with 12000 lb Taperleaf Front Suspension
<b>85959</b> A			
F	04-24	<b>BLUE BIRD</b>	ALL AMERICAN FE All Buses with Hendrickson Airtek Front Air Suspension (10,000 lb Capacity)
F	04-24	ALL AMERICAN FE	All Buses with Hendrickson Airtek Front Air Suspension (13, 200 to 14,600 lb Capacity)
F	04-24	ALL AMERICAN FE	All Buses with Hendrickson Softek Suspension (8,500 lb - 10,000 lb Capacity)
F	04-24	ALL AMERICAN RE	All Buses with Hendrickson Airtek Front Air Suspension (10,000 lb Capacity)
F	04-24	ALL AMERICAN RE	All Buses with Hendrickson Airtek Front Air Suspension (13, 200 to 14,600 lb Capacity)
F	04-24	ALL AMERICAN RE	All Buses with Hendrickson Softek Suspension (8,500 lb - 10,000 lb Capacity)
F	10-13	D3 SERIES (FE & RE MODELS)	
F	04-24	VISION SCHOOL BUS	All Buses with Hendrickson Airtek Front Air Suspension (10,000 lb Capacity)
F	04-24	VISION SCHOOL BUS	All Buses with Hendrickson Airtek Front Air Suspension (13, 200 to 14,600 lb Capacity)
F	04-24	VISION SCHOOL BUS	All Buses with Hendrickson Softek Suspension (8,500 lb - 10,000 lb Capacity)
F	13-24	<b>DYNAMAX CORP</b>	DX3 All Models with 8000 to 16000 lb Front Axle and Taperleaf Spring
F	09-14	DYNAQUEST ST	All Models with 8000 to 16000 lb Front Axle and Taperleaf Spring
F	21-24	EUROPA	All Models with 8000 to 16000 lb Front Axle and Taperleaf Spring
F	19-21	FORCE HD	
F	22	FORCE HD	All Models with 8000 to 16000 lb Front Axle and Taperleaf Spring
F	15-18	FORCE HD	All Models with 8000 to 16000 lb Front Axle and Taperleaf Spring
F	09-13	GRAND SPORT GT TOY HAULER	All 390TH Models with 12000 lb Taperleaf Front Suspension
F	09-19	<b>FEDERAL COACH</b>	VARIOUS
F	12-24	<b>FREIGHTLINER</b>	108SD All All Models with 12,000 to 16,000 lb. Front Axle and Taperleaf Spring
F		MC CHASSIS	
F		MC CHASSIS	
F		<b>HENDRICKSON TRUCK SUSPENSION SYSTEMS</b>	AIRTEK - SERIES
F		ALL AMERICAN SERIES (FE & RE MODELS)	
F	16-23	<b>LION LIONC</b>	All Buses with Hendrickson Softek Suspension (10,000 lb - 12,600 lb Capacity)

## Numerical listing

Shock	POP	Alternative No.	MTG Acc. Supplied
Pos.	Year	Application	
<b>85959</b> A (cont)			
F		<b>MC NEILUS TRUCK &amp; MAN.</b>	VARIOUS
F	13-21	<b>PETERBILT</b>	579 All Models with Peterbilt Front Air Leaf Suspension
F	11-13	587	All Models with Peterbilt Front Air Leaf Suspension
F	09-24	<b>PIERCE MFG. INC.</b>	VARIOUS
F	16-19	<b>RENEGADE</b>	VARIOUS
F		<b>SPARTAN MOTORS</b>	VARIOUS
F		<b>TIFFIN MOTORHOMES INC.</b>	VARIOUS
F		<b>XOS ADDITIONAL O.E.M.</b>	INTERCHANGES
<b>85961</b> W			
R		<b>HENDRICKSON TRUCK SUSPENSION SYSTEMS</b>	FIREMAAX - SERIES
R	22-24	<b>KENWORTH</b>	T480 All Models with Drum Brakes with 8 1/2" to 10" Ride Height
<b>85962</b> W			
R		<b>HENDRICKSON TRUCK SUSPENSION SYSTEMS</b>	FIREMAAX - SERIES
R		<b>MC NEILUS TRUCK &amp; MAN.</b>	VARIOUS
R		<b>SPARTAN MOTORS</b>	RV MODELS
<b>85963</b> W			
F	09-18	<b>INTERNATIONAL</b>	LONESTAR All Models with 12,350 lb Front Mono Leaf Spring Suspension
F		PROSTAR	
F	09-18	PROSTAR	All Models with 12,350 lb Front Mono Leaf Spring Suspension
<b>85964</b> D			
F	09-21	<b>INTERNATIONAL</b>	LONESTAR All Sleeper Cab models with 14,000 lb Parabolic Taperleaf Front Spring
F	21	LONESTAR	All
F		PROSTAR	
<b>85965</b> W			
R	13	<b>AUTOCAR LLC.</b>	XPERT
R	14-23	XPERT	All 4 X 2 Models (CLASS 8) with Hendrickson EX-262 Air Suspensions
R	12	XPERT	All 4 X 2 Models (CLASS 8) with Hendrickson EX-262 Air Suspensions
R		<b>HENDRICKSON TRUCK SUSPENSION SYSTEMS</b>	FIREMAAX - SERIES
R		PRIMAAX - SERIES	
R	17-22	<b>INTERNATIONAL</b>	HX515 All Models with Hendrickson Primaax 520 Rear Air Suspension (10" Ride Height-Drum Brakes only)
R	18-22	HX520	All Models with Hendrickson Primaax 520 Rear Air Suspension (10" Ride Height-Drum Brakes only)
R	17-22	HX615	All Models with Hendrickson Primaax 520 Rear Air Suspension (10" Ride Height-Drum Brakes only)
R	17-22	HX620	All Models with Hendrickson Primaax 520 Rear Air Suspension (10" Ride Height-Drum Brakes only)
R		<b>KENWORTH</b>	VARIOUS
R		<b>MC NEILUS TRUCK &amp; MAN.</b>	VARIOUS
R		<b>PIERCE MFG. INC.</b>	VARIOUS
<b>85967</b> D			
R	08-23	<b>AUTOCAR LLC.</b>	XPEDITOR All Models with Hendrickson Primaax EX 462 Air Suspensions with 12 1/2" - 14 3/8" - 15 1/2" Ride Height
R	13	XPERT	
R	14-23	XPERT	All Models with Hendrickson Primaax EX 462 Air Suspensions with 12 1/2" - 14 3/8" - 15 1/2" Ride Height
R	12	XPERT	All Models with Hendrickson Primaax EX 462 Air Suspensions with 12 1/2" - 14 3/8" - 15 1/2" Ride Height
R	11-17	<b>CATERPILLAR</b>	CT660 All Models with Hendrickson Primaax EX 232, 462 and 692 Air Suspension (13" Ride Height)

## Numerical listing

Shock	POP	Alternative No.	MTG Acc. Supplied
Pos.	Year	Application	
<b>85967</b>		D (cont)	
R		<b>HENDRICKSON TRUCK SUSPENSION SYSTEMS FIREMAAX - SERIES</b>	
R		<b>PRIMAAX - SERIES</b>	
R	12-17	<b>KENWORTH T440</b>	
R	11-23	T680 All Models with Hendrickson Primaax EX 462 Air Suspensions with 12 1/2" - 14 3/8" - 15 1/2" Ride Height	
R	11-19	T880 All Models with Hendrickson Primaax EX 462 Air Suspensions (Standard with 12 1/2" - 14 3/8" - 15 1/2" Ride Height)	
R		<b>VARIOUS</b>	
R		<b>MC NEILUS TRUCK &amp; MAN.</b>	
R		<b>VARIOUS</b>	
<b>85970</b>		W	<b>145089-000 (1)</b>
R	01-09	<b>MOTOR COACH INDUSTRIES E - SERIES COACHES</b>	
R	08	J4500	
R	04-06	J4500	
R	09-19	J4500 All (Drive Axle)	
R	07	J4500 All (Drive Axle)	
R	01-03	J4500 All (Drive Axle)	
<b>85972</b>		W	
F	10	<b>MACK LE</b> All LEU 613 Models with 20,000 lb Front Axle	
F	10-16	LEU All LEU 613 Models with 20,000 lb Front Axle	
F	19-24	LR All LR64R Models with 20,000 lb Front Axle	
F	08-19	MRU All MRU613 Models with 20,000 lb Front Axle	
F	18-21	TERRAPRO All Models with 20,000 lb Front Axle	
<b>85976</b>		D	
R	13	<b>AUTOCAR LLC. XPERT</b>	
R	14-23	XPERT All 4 X 2 Models with Hendrickson HAS-210 or HAS-230 Air Suspensions	
R	12	XPERT All 4 X 2 Models with Hendrickson HAS-210 or HAS-230 Air Suspensions	
R		<b>BLUE BIRD ADDITIONAL APPLICATIONS</b>	
R	14	<b>FORD F-650</b>	
R	15	F-650 All Models with Hendrickson HAS - 230 Rear Air Suspension	
R	04-13	F-650 All Models with Hendrickson HAS - 230 Rear Air Suspension	
R	14	F-750	
R	15	F-750 All Models with Hendrickson HAS - 230 Rear Air Suspension	
R	04-13	F-750 All Models with Hendrickson HAS - 230 Rear Air Suspension	
R		<b>HENDRICKSON TRUCK SUSPENSION SYSTEMS HA - SERIES</b>	
R		<b>HAS - SERIES</b>	
R	20	<b>INTERNATIONAL 4300</b> All Models with Hendrickson HAS - 230 or 460 Rear Air Suspension	
R	15	4300 All Models with Hendrickson HAS - 230 or 460 Rear Air Suspension	
R	02-20	4400 All Models with Hendrickson HAS - 230 or 460 Rear Air Suspension	
R	02-20	7300 All Models with Hendrickson HAS - 230 or 460 Rear Air Suspension	
R	02-20	7400 All Models with Hendrickson HAS - 230 or 460 Rear Air Suspension	
R	02-20	7500 All Models with Hendrickson HAS - 230 or 460 Rear Air Suspension	
R	18-19	7600	
R	08	7600	
R	09-17	7600 All Models with Hendrickson HAS - 230 or 460 Rear Air Suspension	
R	03-07	7600 All Models with Hendrickson HAS - 230 or 460 Rear Air Suspension	
R	05-07	7700 All Models with Hendrickson HAS - 230 or 460 Rear Air Suspension	
R	00-18	9900I All Models with Hendrickson HAS - 230 or 460 Rear Air Suspension	

## 85000 Series

Shock	POP	Alternative No.	MTG Acc. Supplied
Pos.	Year	Application	
<b>85976</b>		D (cont)	
R	00-03	9900I SFA All Models with Hendrickson HAS - 230 or 460 Rear Air Suspension	
R	00-09	9900IX All Models with Hendrickson HAS - 230 or 460 Rear Air Suspension	
R	01-03	9900IX SFA All Models with Hendrickson HAS - 230 or 460 Rear Air Suspension	
R	17-22	HX515 All Models with Hendrickson HAS - 230 or 460 Rear Air Suspension	
R	18-23	HX520 All Models with Hendrickson HAS - 230 or 460 Rear Air Suspension	
R	17-22	HX615 All Models with Hendrickson HAS - 230 or 460 Rear Air Suspension	
R	17-24	HX620 All Models with Hendrickson HAS - 230 or 460 Rear Air Suspension	
R	09-23	LONESTAR All Models with Hendrickson HAS - 230 or 460 Rear Air Suspension	
R	20	MV All Models with Hendrickson HAS - 230 or 460 Rear Air Suspension	
R	08-20	PROSTAR All Models with Hendrickson HAS - 230 or 460 Rear Air Suspension	
R	15-20	WORKSTAR 7300 All Models with Hendrickson HAS - 230 or 460 Rear Air Suspension	
R	15-20	WORKSTAR 7400 All Models with Hendrickson HAS - 230 or 460 Rear Air Suspension	
R	15-20	WORKSTAR 7600 All Models with Hendrickson HAS - 230 or 460 Rear Air Suspension	
R	08-12	WORKSTAR 7700 All Models with Hendrickson HAS - 230 or 460 Rear Air Suspension	
R	20-23	<b>KENWORTH T370</b> All Models with Hendrickson 46,000 lb Primaax Rear Air Suspension	
R	12-24	T800 All Models with Hendrickson 46,000 lb Primaax Rear Air Suspension	
R	11-24	T880 All Models with Hendrickson 46,000 lb Primaax Rear Air Suspension	
R	20-24	W900 All Models with Hendrickson 46,000 lb Primaax Rear Air Suspension	
R	19-24	W990 All Models with Hendrickson 46,000 lb Primaax Rear Air Suspension	
R		<b>MC NEILUS TRUCK &amp; MAN. VARIOUS</b>	
R	19-22	<b>PIERCE MFG. INC. VARIOUS WESTERN STAR 5900 &amp; 6900 SERIES - HERITAGE CLASS</b>	
<b>85977</b>		W	<b>145128 (1)</b>
R		<b>HENDRICKSON TRUCK SUSPENSION SYSTEMS HAS - SERIES</b>	
R		<b>MC NEILUS TRUCK &amp; MAN. VARIOUS</b>	
<b>85978</b>		B	
R	21-24	<b>FORD F-650</b> All Models with Hendrickson HAS - 400/460 Rear Air Suspension	
R	15-19	F-650 All Models with Hendrickson HAS - 400/460 Rear Air Suspension	
R	21-24	F-750 All Models with Hendrickson HAS - 400/460 Rear Air Suspension	
R	15-19	F-750 All Models with Hendrickson HAS - 400/460 Rear Air Suspension	
R		<b>HENDRICKSON TRUCK SUSPENSION SYSTEMS HAS - SERIES</b>	
R	18-24	<b>MACK ANTHEM</b> All Models with Hendrickson HAS 400 or 460 Series Rear Suspension	
R	04-07	CHU	
R	08-19	CHU All CHU-613 Models with Hendrickson HAS 400 or 460 Series Rear Suspension	
R	15-22	GRANITE All Models with Hendrickson HAS 400 or 460 Series Rear Suspension	

## Numerical listing

Shock	POP	Alternative No.	MTG Acc. Supplied
Pos.	Year	Application	
<b>85978</b>		B (cont)	
R	12-19	GU4 All GU432 Models with Hendrickson HAS 400 or 460 Series Rear Suspension	
R	12-18	GU5 All GU533 Models with Hendrickson HAS 400 or 460 Series Rear Suspension	
R	08-19	GU7 All GU713 Models with Hendrickson HAS 400 or 460 Series Rear Suspension	
R	08-19	GU8 All GU813 Models with Hendrickson HAS 400 or 460 Series Rear Suspension	
R	18-22	PINNACLE All Models with Hendrickson HAS 400 or 460 Series Rear Suspension	
R	10-17	TD700 All TD713 Models with Hendrickson HAS 400 or 460 Series Rear Suspension	
R	08-17	TITAN All Models with Hendrickson HAS 400 or 460 Series Rear Suspension	
R	17-19	<b>VOLVO VAH 430</b> All VAH 430 Models with Hendrickson HAS 400 or 460 Series Rear Suspension	
R	11-16	VAH SERIES	
R	17-20	VNL 760 All Models with Hendrickson HAS 400 or 460 Series Rear Suspension	
R	18	VNR All Models with Hendrickson HAS 400 or 460 Series Rear Suspension	
<b>85979</b>		W	
R		<b>KENWORTH T880</b>	
R		<b>MC NEILUS TRUCK &amp; MAN. VARIOUS</b>	
R		<b>WESTERN STAR 5900 &amp; 6900 SERIES - HERITAGE CLASS</b>	
<b>85985</b>		W	<b>145089-200 (1)</b>
R	10-16	<b>KENWORTH T470</b>	
R	07-20	T660 All Models with Air Glide 230 (AG230) Rear Air Suspension	
R	11-16	T700 All Models with Air Glide 230 (AG230) Rear Air Suspension	
R	07-18	T800 All Models with Air Glide 230 (AG230) Rear Air Suspension	
R	06-09	T800B, T800B(8X4), T800SH, T800H, T800W	
R	07-18	W900 All Models with Air Glide 230 (AG230) Rear Air Suspension	
<b>85988</b>		D	<b>145099 (1)</b>
R	14-18	<b>PETERBILT 320</b> All Models with Air Trac Suspension (40,000 lb)	
R	14-21	330 All Models with Air Trac Suspension (40,000 lb)	
R	14-21	337 All Models with Air Trac Suspension (40,000 lb)	
R	14-21	348 All Models with Air Trac Suspension (40,000 lb)	
R	14-21	365 All Models with Air Trac Suspension (40,000 lb)	
R	14-24	367 All Models with Air Trac Suspension (40,000 lb)	
R	13-16	386 All Models with Air Trac Suspension (40,000 lb)	
R	14-15	388 All Models with Air Trac Suspension (40,000 lb)	
R	14-24	389 All Models with Air Trac Suspension (40,000 lb)	
R	17-22	520 All Models with Air Trac Suspension (40,000 lb)	
R	22-24	537 All Models with Air Trac Suspension (40,000 lb)	
R	22-24	548 All Models with Air Trac Suspension (40,000 lb)	
R	14-24	567 All Models with Air Trac Suspension (40,000 lb)	
R	14-24	579 All Models with Air Trac Suspension (40,000 lb)	
<b>85989</b>		A	
F	16-17	<b>KENWORTH ICON 900</b>	
F	21-23	T280 All Models with 10,000 lb to 12,000 lb Mono-leaf front springs	
F	15-22	T370 All Models with 10,000 lb to 14,600 lb Taperleaf Springs and Set Back Front Axles	
F	15-22	T370 All Models with 16,000 lb to 20,000 lb Taperleaf Springs and Set Back Front Axles	
F	22-24	T380 All Models with 10,000 lb to 14,600 lb Taperleaf Springs	

Numerical listing

85000 Series, 86000 Series, 87000 Series, 89000 Series

Numerical listing

Shock	POP	Alternative No.	MTG Acc. Supplied
Pos.	Year	Application	
<b>85989</b> A (cont)			
F	22-24	T480	All Models with 10,000 lb to 12,000 lb Mono-leaf front springs
F	22-24	T480	All Models with 10,000 lb to 14,600 lb Taperleaf Springs
F	22-24	T480	All Models with 16,000 lb to 20,000 lb Taperleaf Springs and Set Back Front Axles
F	14-24	T680	All Models with 10,000 lb to 14,600 lb Taperleaf Springs and Set Back Front Axles
F	14-23	T680	All Models with 16,000 lb to 20,000 lb Taperleaf Springs and Set Back Front Axles
F	14-24	T880	All Models with 16,000 lb to 20,000 lb Taperleaf Springs and Set Back Front Axles
F	14-23	T880	All Models with 10,000 lb to 14,600 lb Taperleaf Springs and Set Back Front Axles
F	16-22	PETERBILT 330	All Models with 10,000 lb to 14,600 lb Taperleaf Springs and Set Back Front Axles
F	15-23	337	All Models with 10,000 lb to 14,600 lb Taperleaf Springs and Set Back Front Axles
F	14-23	348	All Models with 20,000 lb Taperleaf Springs and Set Back Front Axles
F	14-22	348	All Models with 10,000 lb to 14,600 lb Taperleaf Springs and Set Back Front Axles
F	22-24	537	All Models with 10,000 lb to 14,600 lb Taperleaf Springs and Set Back Front Axles
F	22	537	All Models with 16,000 lb to 20,000 lb Taperleaf Springs and Set Back Front Axles
F	22-24	548	All Models with 10,000 lb to 14,600 lb Taperleaf Springs and Set Back Front Axles
F	22-24	548	All Models with 20,000 lb Taperleaf Springs and Set Back Front Axles
F	14-23	567	All Models with 10,000 lb to 14,600 lb Taperleaf Springs and Set Back Front Axles
F	14-23	567	All Models with 20,000 lb Taperleaf Springs and Set Back Front Axles
F	13-24	579	All Models with 10,000 lb to 14,600 lb Taperleaf Springs and Set Back Front Axles
<b>85994</b> C			
F	17-24	INTERNATIONAL LT625	All LT-625 Models with 12,000 lb - 13,200 lb Mono-Leaf Spring Suspension
F	17-23	LT625	All LT-625 Models with 12,000 - 14,000 lb Taperleaf Spring Suspension
F	20	LT	All LT-625 Models with 12,000 lb - 13,200 lb Mono-Leaf Spring Suspension
F		PROSTAR	
F	21	PROSTAR	
F	16-20	PROSTAR	All Sleeper Cabs with 12,000 lb - 13,200 lb Mono-Leaf Spring Suspension
F	16-17	PROSTAR	All Models with Day Cab and 12,000 - 14,000 lb Taperleaf Front Spring Suspension
F	14-15	PROSTAR	All Models with Sleeper Cab and 12,350 lb Leaf Spring Suspension
F	18-24	RH613	All RH-613 Models with 12,000 lb - 13,200 lb Mono-Leaf Spring Suspension
F	18-20	RH613	All RH Models with 12,000 - 14,000 lb Taperleaf Spring Suspension
<b>85995</b> W			
F	13-18	INTERNATIONAL 9900I	All Models with 12,000 lb Front axle
F	19-21	HV607	All Models with 18,000 to 20,000 lb (Set Forward) Front Axle
F	19-21	HV613	All Models with 18,000 to 20,000 lb (Set Forward) Front Axle
F	13-20	LONESTAR	All Models with O.E.M. Number
F	21	PROSTAR	
F	13-20	PROSTAR	All Models with 113" Sleeper Cab
F	19-21	PIERCE MFG. INC.	VARIOUS

Shock	POP	Alternative No.	MTG Acc. Supplied
Pos.	Year	Application	
<b>86000 Series</b>			
F		B	
R		MERITOR MTA 25T / MTA 30T	TRAILER AIR SUSPENSION
<b>87000 Series</b>			
F		D	
R		EAST MANUFACTURING CORP.	VARIOUS
R		MERITOR FS230 TRAILER	SUSPENSION
R		VARIOUS	
F		W	145116(1)/145090(1)
F		ORION BUS	VARIOUS
F		W	
R		HENDRICKSON TRAILER	SUSPENSION SYSTEMS TOP MOUNT STYLE
R		VARIOUS	UNDERSLUNG STYLE
<b>89000 Series</b>			
F		W	140149 (1)
F	96-98	FORD A9513	All Models with 10000 lb Axle and 54" Multileaf Spring
F	96-98	AT9513	All Models with 10000 lb Axle and 54" Multileaf Spring
F	97-98	AT9522	All Models with 10000 lb Axle and 54" Multileaf Spring
F	90-97	L8000F	All Models with 58" Parabolic Taperleaf Spring
F	91-97	L9000	All Models with 58" Parabolic Taperleaf Spring
F	91-97	LA8000F	All Models with 52" or 58" Taperleaf Spring
F	90-97	LN7000	All Models with 58" Parabolic Taperleaf Spring
F	90-97	LN8000	All Models with 58" Parabolic Taperleaf Spring
F	90-97	LN9000	All Models with 58" Parabolic Taperleaf Spring
F	90-97	LNT8000F	All Models with 58" Parabolic Taperleaf Spring
F	90-97	LNT9000	All Models with 58" Parabolic Taperleaf Spring
F	96-97	LOUISVILLE SERIES - CONVENTIONAL CAB	
F	90-97	LS8000F	All Models with 52" or 58" Taperleaf Spring
F	91-97	LT9000	All Models with 58" Parabolic Taperleaf Spring
F	98-09	STERLING TRUCK A - LINE 9500 SERIES (SILVERSTAR)	
F		L - LINE 7500 SERIES - SHORT HAUL TRACTOR	
F	98	L - LINE 8500 SERIES - CONVENTIONAL CAB	
F	98-09	L - LINE 9500 SERIES - CONVENTIONAL CAB	
F		W	
R		AUTOCAR LLC.	ADDITIONAL APPLICATIONS
R	16-24	XPRT	All Models with Hendrickson HTS 210 Suspension
R		BLUE BIRD ALL AMERICAN SERIES (FE & RE MODELS)	
R	81-91	FORD CL9000	All Models with Rear Tandem Axle with Neway Suspension
R	78-80	CL & CLT SERIES - HIGHWAY TRACTOR TILT CAB	
R	81-91	CLT9000	All Models with Rear Tandem Axle with Neway Suspension
R	00-03	F-650	All Models with Hendrickson HAS - 190 Rear Air Suspension
R	00-03	F-750	All Models with Hendrickson HAS - 190 Rear Air Suspension
R		GILLIG	VARIOUS
R		HENDRICKSON TRUCK	SUSPENSION SYSTEMS
R		VARIOUS	ADDITIONAL APPLICATIONS
R		HA - SERIES	
R		HC - SERIES	
R	03-18	IC CORPORATION	RE SCHOOL BUS All RE Model School Buses (Low Profile)
R		INTERNATIONAL F & S SERIES	3000 - SCHOOL BUS CHASSIS
R		VARIOUS	SERIES 9600 & 9700 PREMIUM CABOVER TRACTOR

Shock	POP	Alternative No.	MTG Acc. Supplied
Pos.	Year	Application	
<b>89405</b> W (cont)			
R		S SERIES	SCHOOL BUS
R	93-05	KENWORTH K300	All Models with Hendrickson Rear Air Suspension
R	13-24	K370	All Models with Hendrickson HAS - 210L or HAS - 230L Rear Air Suspension
R	21-24	T280	All Models with Hendrickson HAS - 210L or HAS - 230L Rear Air Suspension
R		T300	
R	01-08	T300	All Models with Hendrickson HAS - 210L or HAS - 230L Rear Air Suspension
R	95-99	T300	All Models with Hendrickson HAS - 210L or HAS - 230L Rear Air Suspension
R	08-23	T370	All Models with Hendrickson HAS - 210L or HAS - 230L Rear Air Suspension
R	93-08	T600A	All Models with Hendrickson HAS - 210L or HAS - 230L Rear Air Suspension
R	93-24	T800	All Models with Hendrickson HAS - 210L or HAS - 230L Rear Air Suspension
R	93-24	W900	All Models with Hendrickson HAS - 210L or HAS - 230L Rear Air Suspension
R	16-23	LION LIONC	All Models with Hendrickson HTS 210 Suspension
R	89-05	MACK CH	All CH600 Models with Hendrickson Rear Air Suspension
R	91-07	CL	All CL600, CL700 Models with Hendrickson Rear Air Suspension
F	01-08	CV	All CV-713 Models with 18,000 lb Front Axles
R	15-24	GRANITE	All Models with Hendrickson HAS Series Rear Suspension
R	08-19	GU7	All GU713 Models with Hendrickson HAS Series Rear Suspension
R	08-19	GU8	All GU813 Models with Hendrickson HAS Series Rear Suspension
R	83-94	MH	All MH Models with Neway ARD-234 Air Suspension
F	81-07	MR	All Models with Front Taperleaf Springs
F	81-91	R	All Models with Front Taperleaf Springs
F	81-91	R	All R, U, RD 600 Models/ MR600 Models with Front Taperleaf Springs
F	81-91	R	All R600 Models-3 1/2" Wide springs
F	07	RD	All Models with Front Taperleaf Springs
F	07	RD	All RD600 Models-3 1/2" Wide springs
F	81-04	RD	All Models with Front Taperleaf Springs
F	81-04	RD	All RD600 Models-3 1/2" Wide springs
R	85-93	RW	All RW Models with Neway ARD-234 Air Suspension
R	10-17	TD700	All Titan TD713 Models with Hendrickson HAS Series Rear Suspension
R	08-17	TITAN	All Models with Hendrickson HAS Series Rear Suspension
F	81-89	U	All Models with Front Taperleaf Springs
R		MC NEILUS TRUCK & MAN.	VARIOUS
R	13-24	PETERBILT 220	All Models with Hendrickson HAS - 210L or HAS - 230L Rear Air Suspension
R	10	220	All Models with Hendrickson HAS - 210L or HAS - 230L Rear Air Suspension
R	07	220	All Models with Hendrickson HAS - 210L or HAS - 230L Rear Air Suspension
F	86-08	357	All Conventional Models with Front Air Suspension and without Set Back Front Axle.
F	86-06	362	All C.O.E. Models with 14600 lb Taper Leaf Springs and Set Back Front Axle
F	87-96	375	All Conventional Models with Front Air Suspension and without Set Back Front Axle.



## Numerical listing

Shock	POP	Alternative No.	MTG Acc. Supplied
Pos.	Year	Application	
<b>89405</b> W (cont)			
F	99	376	All Conventional Models with Front Air Suspension and without Set Back Front Axle.
F	94-96	376	All Conventional Models with Front Air Suspension and without Set Back Front Axle.
F	88-92	376	All Conventional Models with Front Air Suspension and without Set Back Front Axle.
F	87-01	377	All Conventional Models with Front Air Suspension and without Set Back Front Axle.
F	88-07	378	All Conventional Models with Front Air Suspension and without Set Back Front Axle.
F	86-07	379	All Conventional Models with Front Air Suspension and without Set Back Front Axle.
F	06-16	386	All Conventional Models with Front Air Suspension and without Set Back Front Axle.
F	00-11	387	All Conventional Models with Front Air Suspension and without Set Back Front Axle.
F	08-15	388	All Conventional Models with Front Air Suspension and without Set Back Front Axle.
F	08-21	389	All Conventional Models with Front Air Suspension and without Set Back Front Axle.
R			<b>REYCO SUSPENSION DRIVE AXLE</b>
R			<b>TRAILER</b>
R			<b>SAF HOLLAND TRAILER AIR SUSPENSION</b>
R			<b>TRUCK, BUS &amp; MOTORHOME AIR SUSPENSIONS</b>
R			<b>TRUCK &amp; TRACTOR AIR SUSPENSION (TAG AXLE)</b>
R			<b>SPARTAN MOTORS VARIOUS</b>
R			<b>TUTHILL TECHNOLOGIES DRIVE AXLE</b>
R	06		<b>VOLVO VHD</b> All Models with Hendrickson HAS Series Rear Suspension
R			<b>WATSON &amp; CHALIN MFG. INC.</b> WCTA SERIES DUMP TRAILER AIR SUSPENSION
R			<b>XOS</b> ADDITIONAL O.E.M. INTERCHANGES
<b>89406</b> W			
R			<b>ALLCO TRAILER</b> VARIOUS
F			<b>AUTOCAR LLC.</b> ADDITIONAL APPLICATIONS
R	97-09		<b>CHEVROLET</b> C6500 KODIAK All Models with Hendrickson Air Suspension (Stamping number 47902-13)
R	02-09		C7500 KODIAK All Models with Hendrickson Air Suspension (Stamping number 47902-13)
R	97-99		C7500 KODIAK All Models with Hendrickson Air Suspension (Stamping number 47902-13)
R	03-09		C8500 All Models with Hendrickson Air Suspension (Stamping number 47902-13)
R	99		T7500 All Models with Hendrickson Air Suspension (Stamping number 47902-13)
R	04-09		T8500 All Models with Hendrickson Air Suspension (Stamping number 47902-13)
R	09		<b>COACHMEN</b> AURORA
R	07		AURORA
R	99-07		MIRADA
R	04-12		PURSUIT
R	00-14		<b>DAMON</b> CHALLENGER All MotorHomes with Ford F53 Chassis with 16,000 lb GVW to 22,000 lb GVW
R	12-13		DAYBREAK
R	99		DAYBREAK
R	00-11		DAYBREAK All MotorHomes with Ford F53 Chassis with 16,000 lb GVW to 22,000 lb GVW
R	99		INTRUDER
R	00-07		INTRUDER All MotorHomes with Ford F53 Chassis with 16,000 lb GVW to 22,000 lb GVW
R	12-14		OUTLAW

## 89000 Series

Shock	POP	Alternative No.	MTG Acc. Supplied
Pos.	Year	Application	
<b>89406</b> W (cont)			
R	07-11		<b>OUTLAW</b> All MotorHomes with Ford F53 Chassis with 16,000 lb GVW to 22,000 lb GVW
R	19-24		<b>ENTEGRA COACH EMBLEM</b> All MotorHomes with Ford F53 Chassis with 16,000 lb GVW to 22,000 lb GVW
R	19-24		<b>VISION</b> All MotorHomes with Ford F53 Chassis with 16,000 lb GVW to 22,000 lb GVW
R	19-20		<b>FLEETWOOD AXON</b>
R	18		<b>AXON</b> All MotorHomes with Ford F53 Chassis with 16,000 lb GVW to 22,000 lb GVW
R	00-24		<b>BOUNDER</b> All MotorHomes with Ford F53 Chassis with 16,000 lb GVW to 22,000 lb GVW
R	15-24		<b>FLAIR</b> All MotorHomes with Ford F53 Chassis with 16,000 lb GVW to 22,000 lb GVW
R	00-07		<b>FLAIR</b> All MotorHomes with Ford F53 Chassis with 16,000 lb GVW to 22,000 lb GVW
R	23-24		<b>FLEX</b> All MotorHomes with Ford F53 Chassis with 16,000 lb GVW to 22,000 lb GVW
R	20-24		<b>FORTIS</b> All MotorHomes with Ford F53 Chassis with 16,000 lb GVW to 22,000 lb GVW
R	00-23		<b>SOUTHWIND</b> All MotorHomes with Ford F53 Chassis with 16,000 lb GVW to 22,000 lb GVW
R	11-18		<b>STORM</b> All MotorHomes with Ford F53 Chassis with 16,000 lb GVW to 22,000 lb GVW
R	01-07		<b>STORM</b> All MotorHomes with Ford F53 Chassis with 16,000 lb GVW to 22,000 lb GVW
R			<b>FORD CL &amp; CLT SERIES - HIGHWAY TRACTOR TILT CAB</b>
R	06-23		F-53
R	99-04		F-53
R	06-23		F-53 MOTORHOME CHASSIS All Motorhome Chassis with 16,000 lb GVW to 18,000 lb GVW
R	06-23		F-53 MOTORHOME CHASSIS All Motorhome Chassis with 20,500 lb GVW to 22,000 lb GVW
R	99-04		F-53 MOTORHOME CHASSIS All Motorhome Chassis with 16,000 lb GVW to 18,000 lb GVW
R	99-04		F-53 MOTORHOME CHASSIS All Motorhome Chassis with 20,500 lb GVW to 22,000 lb GVW
R	88-97		F-53 MOTORHOME CHASSIS All Motorhome Chassis with 16,000 lb GVW to 18,000 lb GVW
R			L, LT & LTS - CONVENTIONAL CAB
R			LN & LNT - CONVENTIONAL CAB
R			<b>FRUEHAUF</b> VARIOUS
R	99-09		<b>GEORGIE BOY MANUFACTURING</b> CLASS A MOTORHOMES
F			<b>GILLIG</b> VARIOUS
R			VARIOUS
R	95-02		<b>GMC C - SERIES</b> (C6500, C7500, C8500) TOPKICK
R	99		T5500
R	99		T7500 All Models with Hendrickson Air Suspension (Stamping number 47902-13)
R	99		T8500
R			<b>GREAT DANE TRAILER</b> VARIOUS
R			<b>HENDRICKSON TRUCK SUSPENSION SYSTEMS</b> HA - SERIES
R	11-15		<b>HOLIDAY RAMBLER</b> ADMIRAL
R	02-06		ADMIRAL
R	15		ENDEAVOR
R	10		VACATIONER
R	08		VACATIONER
R			<b>ISUZU</b> FVR
R	99-15		<b>ITASCA</b> CLASS A MOTORHOMES
R	14-20		<b>JAYCO</b> CLASS A MOTORHOMES
F			<b>LODAL INC.</b> TRUCK & MAN. VARIOUS
R	12-13		<b>MONACO COACH</b> LA PALMA All MotorHomes with Ford F53 Chassis with 16,000 lb GVW to 22,000 lb GVW
R	09		LA PALMA All MotorHomes with Ford F53 Chassis with 16,000 lb GVW to 22,000 lb GVW

## Numerical listing

Shock	POP	Alternative No.	MTG Acc. Supplied
Pos.	Year	Application	
<b>89406</b> W (cont)			
R	02-06		<b>LA PALMA</b> All MotorHomes with Ford F53 Chassis with 16,000 lb GVW to 22,000 lb GVW
R	00		<b>LA PALMA</b> All MotorHomes with Ford F53 Chassis with 16,000 lb GVW to 22,000 lb GVW
R	06-14		<b>MONARCH</b> All MotorHomes with Ford F53 Chassis with 16,000 lb GVW to 22,000 lb GVW
R	01-02		<b>MONARCH</b> All MotorHomes with Ford F53 Chassis with 16,000 lb GVW to 22,000 lb GVW
R	99-08		<b>NATIONAL RV CLASS A</b> MOTORHOMES
R	13-20		<b>NEWMAR</b> CLASS A MOTORHOMES
R	16-20		<b>NEXUS</b> CLASS A MOTORHOMES
F			<b>OSHKOSH MOTOR TRUCK CO.</b> VARIOUS
F			<b>REYCO SUSPENSION</b> STEER AXLE
R			<b>TRAILER</b>
R			<b>SAF HOLLAND TRUCK, BUS &amp; MOTORHOME</b> AIR SUSPENSIONS
R			<b>TRUCK &amp; TRACTOR AIR SUSPENSION (TAG AXLE)</b>
R	05-08		<b>THOR MOTOR COACH</b> CHALLENGER
R	04-10		HURRICANE
R	07-10		OUTLAW
R	06-10		WINDSPORT
F			<b>TUTHILL TECHNOLOGIES</b> STEER AXLE
R			<b>TRAILER</b>
F			<b>VOLVO</b> ADDITIONAL APPLICATIONS
R	78-83		ADDITIONAL APPLICATIONS
R	98		<b>WESTERN STAR</b> 3800
R	86-88		3800
R	99-01		3800 All Models with Hendrickson Air Suspension
R	89-97		3800 All Models with Hendrickson Air Suspension
R	89-02		4800 All Models with Hendrickson Air Suspension
R	89-02		4900 All Models with Hendrickson Air Suspension
R	97-02		5800 All Models with Hendrickson Air Suspension
R	89-01		5900 All Models with Hendrickson Air Suspension
R	89-01		6900 All Models with Hendrickson Air Suspension
R	23		<b>WINNEBAGO</b> SUNSTAR NPF
R	23		VISTA NPF
<b>89407</b> W			
R			<b>ADVANCE MIXER</b> VARIOUS
R			<b>BENSON TRUCK BODIES INC.</b> VARIOUS
F			<b>BLUE BIRD</b> ALL AMERICAN SERIES (FE & RE MODELS)
F	10-13		D3 SERIES (FE & RE MODELS)
F			<b>BROCKWAY SCHOOL BUS</b> VARIOUS
F			<b>CHANCE COACH</b> TRANSIT BUS VARIOUS
F	73-75		<b>CHEVROLET</b> 6, 60, 6000 & 6500 SERIES
F			<b>COACHMEN</b> CLASS A MOTORHOMES
R	00-10		<b>COUNTRY COACH</b> AFFINITY All MotorHomes with Neway IFS
R	00		<b>CONCEPT</b> All MotorHomes with Neway IFS
R	00-04		<b>MAGNA</b> All MotorHomes with Neway IFS
R	05-10		<b>MAGNA</b> 630 All MotorHomes with Neway IFS
R			<b>DURA SUSPENSION</b> VARIOUS
R			<b>EAST MANUFACTURING CORP.</b> VARIOUS
R	96-98		<b>FORD</b> A9513 All All with Neway AD-246 Air Suspension
R	97		A9522 All All with Neway AD-246 Air Suspension
R	96-98		AT9513 All All with Neway AD-246 Air Suspension
R	97-98		AT9522 All All with Neway AD-246 Air Suspension
R			<b>LOUISVILLE SERIES - CONVENTIONAL CAB</b>
F			<b>FOREST RIVER</b> CLASS A MOTORHOMES

Numerical listing

Shock	POP	Alternative No.	MTG Acc. Supplied
Pos.	Year	Application	
<b>89407</b>	W	(cont)	
F		<b>GEORGIE BOY MANUFACTURING CLASS A MOTORHOMES</b>	
R		<b>GILLIG VARIOUS</b>	
F	73-75	<b>GMC 6000 SERIES</b>	
F	73-75	<b>6500 SERIES</b>	
R		<b>GREAT DANE TRAILER VARIOUS</b>	
R		<b>HARDEE MFG. VARIOUS</b>	
R		<b>HENDRICKSON TRUCK SUSPENSION SYSTEMS HN - SERIES</b>	
R		<b>HIGHWAY PRODUCT VARIOUS</b>	
F		<b>INTERNATIONAL SERIES 9300, 9300I, 9400 &amp; 9400I LONG HOOD CONV.</b>	
F		<b>SERIES 9600 &amp; 9700 PREMIUM CABOVER TRACTOR</b>	
R		<b>SERIES 9600 &amp; 9700 PREMIUM CABOVER TRACTOR</b>	
F		<b>SERIES 9800 - PREMIUM CABOVER TRACTOR</b>	
F		<b>SERIES 9900, 9900I, 9900IX LONG HOOD CONV. TRUCK</b>	
F		<b>ITASCA CLASS A MOTORHOMES</b>	
R	12-16	<b>KENWORTH T440</b>	
R	10-16	<b>T470</b>	
R		<b>T800, T800B, T800B(8X4), T800SH, T800H, T800W</b>	
F		<b>MACK ADDITIONAL APPLICATIONS</b>	
R		<b>ADDITIONAL APPLICATIONS</b>	
F	75-79	<b>ADDITIONAL APPLICATIONS</b>	
R	89-05	<b>CH All CH600 Models with Neway AD Air Suspension Shock w/ extended length of 21.70"</b>	
R	91-07	<b>CL All CL600, CL700 Models with Neway AD Air Suspension Shock w/ extended length of 21.70"</b>	
R	98-05	<b>CX All Models with Neway AD Air Suspension Shock w/ extended length of 21.70"</b>	
F		<b>F SERIES</b>	
F	81-91	<b>R All Models with O.E.M. Number</b>	
F	07	<b>RD All Models with O.E.M. Number</b>	
F	81-04	<b>RD All Models with O.E.M. Number</b>	
R		<b>MC NEILUS TRUCK &amp; MAN. VARIOUS</b>	
F		<b>MONACO COACH CLASS A MOTORHOMES</b>	
F		<b>NATIONAL COACH CORP. VARIOUS</b>	
R		<b>REYCO SUSPENSION TRAILER</b>	
R		<b>RIDEWELL CORP. TRAILER AIR-RIDES</b>	
R		<b>TRUCK AIR-RIDES</b>	
R		<b>SAF HOLLAND TRAILER AIR SUSPENSION</b>	
R		<b>TRUCK, BUS &amp; MOTORHOME AIR SUSPENSIONS</b>	
R		<b>TRUCK &amp; TRACTOR AIR SUSPENSION (TAG AXLE)</b>	
R		<b>TRAILMOBILE CANADA CORP. VARIOUS</b>	
R		<b>TUTHILL TECHNOLOGIIES TRAILER</b>	
R		<b>TWIN COACH VARIOUS</b>	
R	06	<b>VOLVO VHD All All with Neway AD-246 Air Suspension</b>	
R		<b>WABASH NATIONAL VARIOUS</b>	
R		<b>WESTERN STAR 4800 &amp; 4900 SERIES - CONSTELLATION CLASS</b>	
R		<b>4800 &amp; 4900 SERIES - HERITAGE CLASS</b>	
R		<b>5800 &amp; 5900 SERIES - CONSTELLATION CLASS</b>	
R		<b>5900 &amp; 6900 SERIES - HERITAGE CLASS</b>	
F		<b>WORKHORSE VARIOUS</b>	
<b>89408</b>	B	(cont)	<b>145080 (2)</b>
F	23	<b>KENWORTH T880 All Models with 18,000 lb to 23,000 lb Taperleaf Front Spring Suspension and Set Forward Front Axle.</b>	
F	18-20	<b>W900 All Models with 18,000 lb to 23,000 lb Taperleaf Front Spring Suspension and Set Forward Front Axle.</b>	
F		<b>W900, W900B, W900L, W900S</b>	
F	23	<b>W990 All Models with 18,000 lb to 23,000 lb Taperleaf Front Spring Suspension and Set Forward Front Axle.</b>	

89000 Series

Shock	POP	Alternative No.	MTG Acc. Supplied
Pos.	Year	Application	
<b>89408</b>	B	(cont)	<b>145080 (2)</b>
F	01-18	<b>PETERBILT 320 All Models with 18,000 lb to 23,000 lb Taperleaf Front Spring Suspension and Set Forward Front Axle.</b>	
F	87-18	<b>320 All Models with 12,000 lb to 14,600 lb Taperleaf Spring Suspension and Set Forward Front Axle.</b>	
F	87-08	<b>357 All Models with 12,000 lb to 14,600 lb Taperleaf Spring Suspension and Set Forward Front Axle.</b>	
F	87-08	<b>357 All Models with 18,000 lb to 23,000 lb Taperleaf Front Spring Suspension and Set Forward Front Axle.</b>	
F	08-22	<b>365 All Models with 18,000 lb to 23,000 lb Taperleaf Front Spring Suspension and Set Forward Front Axle.</b>	
F	08-20	<b>365 All Models with 12,000 lb to 14,600 lb Taperleaf Spring Suspension and Set Forward Front Axle.</b>	
F	08-24	<b>367 All Models with 18,000 lb to 23,000 lb Taperleaf Front Spring Suspension and Set Forward Front Axle.</b>	
F	14-20	<b>367 All Models with 12,000 lb to 14,600 lb Taperleaf Spring Suspension and Set Forward Front Axle.</b>	
F	87-96	<b>375 All Models with 12,000 lb to 14,600 lb Taperleaf Spring Suspension and Set Forward Front Axle.</b>	
F	87-96	<b>375 All Models with 18,000 lb to 23,000 lb Taperleaf Front Spring Suspension and Set Forward Front Axle.</b>	
F	02	<b>376</b>	
F	00	<b>376</b>	
F	99	<b>376 All Models with 12,000 lb to 14,600 lb Taperleaf Spring Suspension and Set Forward Front Axle.</b>	
F	99	<b>376 All Models with 18,000 lb to 23,000 lb Taperleaf Front Spring Suspension and Set Forward Front Axle.</b>	
F	95-96	<b>376 All Models with 12,000 lb to 14,600 lb Taperleaf Spring Suspension and Set Forward Front Axle.</b>	
F	95-96	<b>376 All Models with 18,000 lb to 23,000 lb Taperleaf Front Spring Suspension and Set Forward Front Axle.</b>	
F	92	<b>376 All Models with 12,000 lb to 14,600 lb Taperleaf Spring Suspension and Set Forward Front Axle.</b>	
F	92	<b>376 All Models with 18,000 lb to 23,000 lb Taperleaf Front Spring Suspension and Set Forward Front Axle.</b>	
F	88-90	<b>376 All Models with 12,000 lb to 14,600 lb Taperleaf Spring Suspension and Set Forward Front Axle.</b>	
F	88-90	<b>376 All Models with 18,000 lb to 23,000 lb Taperleaf Front Spring Suspension and Set Forward Front Axle.</b>	
F	87-01	<b>377 All Models with 12,000 lb to 14,600 lb Taperleaf Spring Suspension and Set Forward Front Axle.</b>	
F	87-01	<b>377 All Models with 18,000 lb to 23,000 lb Taperleaf Front Spring Suspension and Set Forward Front Axle.</b>	
F	88-07	<b>378 All Models with 12,000 lb to 14,600 lb Taperleaf Spring Suspension and Set Forward Front Axle.</b>	
F	88-07	<b>378 All Models with 18,000 lb to 23,000 lb Taperleaf Front Spring Suspension and Set Forward Front Axle.</b>	
F	86-07	<b>379 All Models with 12,000 lb to 14,600 lb Taperleaf Spring Suspension and Set Forward Front Axle.</b>	

Numerical listing

Shock	POP	Alternative No.	MTG Acc. Supplied
Pos.	Year	Application	
<b>89408</b>	B	(cont)	<b>145080 (2)</b>
F	86-07	<b>379 All Models with 18,000 lb to 23,000 lb Taperleaf Front Spring Suspension and Set Forward Front Axle.</b>	
F	11-17	<b>382 All Models with 12,000 lb to 14,600 lb Taperleaf Spring Suspension and Set Forward Front Axle.</b>	
F	08-16	<b>384 All Models with 12,000 lb to 14,600 lb Taperleaf Spring Suspension and Set Forward Front Axle. (Heavy Duty)</b>	
F		<b>385</b>	
F	06-16	<b>386 All Models with 12,000 lb to 14,600 lb Taperleaf Spring Suspension and Set Forward Front Axle.</b>	
F	06-16	<b>386 All Models with 18,000 lb to 23,000 lb Taperleaf Front Spring Suspension and Set Forward Front Axle.</b>	
F		<b>387</b>	
F	13-15	<b>388 All Models with 12,000 lb to 14,600 lb Taperleaf Spring Suspension and Set Forward Front Axle. (Heavy Duty)</b>	
F	08-15	<b>388 All Models with 12,000 lb to 14,600 lb Taperleaf Spring Suspension and Set Forward Front Axle.</b>	
F	08-15	<b>388 All Models with 18,000 lb to 23,000 lb Taperleaf Front Spring Suspension and Set Forward Front Axle.</b>	
F	08-24	<b>389 All Models with 12,000 lb to 14,600 lb Taperleaf Spring Suspension and Set Forward Front Axle.</b>	
F	08-23	<b>389 All Models with 18,000 lb to 23,000 lb Taperleaf Front Spring Suspension and Set Forward Front Axle.</b>	
F	17-24	<b>520 All Models with 18,000 lb to 23,000 lb Taperleaf Front Spring Suspension and Set Forward Front Axle.</b>	
F	14-24	<b>567 All Models with 12,000 lb to 14,600 lb Taperleaf Spring Suspension and Set Forward Front Axle.</b>	
F	14-23	<b>567 All Models with 18,000 lb to 23,000 lb Taperleaf Front Spring Suspension and Set Forward Front Axle.</b>	
F	13-18	<b>579 All Models with 12,000 lb to 14,600 lb Taperleaf Spring Suspension and Set Forward Front Axle.</b>	
F	11-18	<b>587 All Models with 12,000 lb to 14,600 lb Taperleaf Spring Suspension and Set Forward Front Axle.</b>	
<b>89409</b>	W	(cont)	<b>140149 (1)</b>
F	80-86	<b>FORD C700 All Models with 4040, 5040 lb Springs and 7000, 9000, 12000 lb Axles</b>	
F	80-86	<b>C800 All Models with 4040, 5040 lb Springs and 7000, 9000, 12000 lb Axles</b>	
F	80-86	<b>C7000 All Models with 4040, 5040 lb Springs and 7000, 9000, 12000 lb Axles</b>	
F	87-90	<b>C &amp; CT SERIES - TILT CAB</b>	
F	67-79	<b>C &amp; CT SERIES - TILT CAB</b>	
F	81-86	<b>CT8000 All Models with 4040, 5040 lb Springs and 7000, 9000, 12000 lb Axles</b>	
F	73-79	<b>F SERIES - CONVENTIONAL CAB</b>	
F	64-69	<b>F SERIES - CONVENTIONAL CAB</b>	
F	80-85	<b>L800 All Models with 7000, 9000, 12000 lb Axles</b>	
F	81	<b>L900 All Models with 7000, 9000, 12000 lb Axles</b>	
F	81-88	<b>L8000 All Models with 7000, 9000, 12000 lb Axles</b>	
F	91-97	<b>L8000F All Models with Multleaf Spring</b>	
F	91-97	<b>L9000 All Models with Multleaf Spring</b>	
F	81-97	<b>L9000 All Models with 7000, 9000, 12000 lb Axles</b>	
F	73-89	<b>L, LT &amp; LTS - CONVENTIONAL CAB</b>	

## Numerical listing

Shock	POP	Alternative No.	MTG Acc. Supplied
Pos.	Year	Application	
<b>89409</b>	W	(cont)	<b>140149 (1)</b>
F	80-86	LN7000	All Models with 4400 lb Spring and 7000, 9000 lb Axles
F	80-85	LN8000	All Models with 4400 lb Spring and 7000, 9000 lb Axles
F	90-97	LN7000	All Models with Multileaf Spring
F	81-97	LN7000	All Models with 4400 lb Spring and 7000, 9000 lb Axles
F	90-97	LN8000	All Models with Multileaf Spring
F	81-97	LN8000	All Models with 4400 lb Spring and 7000, 9000 lb Axles
F	90-97	LN9000	All Models with Multileaf Spring
F	70-89	LN & LNT - CONVENTIONAL CAB	
F	81-84	LNT800	All Models with 4400 lb Spring and 7000, 9000 lb Axles
F	81-89	LNT8000	All Models with 4400 lb Spring and 7000, 9000 lb Axles
F	90-97	LNT8000F	All Models with Multileaf Spring
F	90-97	LNT9000	All Models with Multileaf Spring
F	81-84	LT800	All Models with 7000, 9000, 12000 lb Axles
F	81-88	LT8000	All Models with 7000, 9000, 12000 lb Axles
F	91-97	LT9000	All Models with Multileaf Spring
F	81-97	LT9000	All Models with 7000, 9000, 12000 lb Axles
F	81-89	LTS9000	All Models with 16000 lb Axle
F	64-69	N AND NT 89" BBC CONVENTIONAL CAB	
F		<b>KENWORTH C500, C500B, C500K, C540 &amp; C550</b>	
F		<b>K100, K100E, K125</b>	
F	93-05	K300	All Models with Multiple Leaf Springs on Front Axle (3/4" Mounting bolts)
F		T300	
F		T400, T400B, T450B	
F		T600, T600A, T600B, T602	
F		T800, T800B, T800B(8X4), T800SH, T800H, T800W	
F		T2000	
F		W900, W900B, W900L, W900S	
F		<b>OSHKOSH MOTOR TRUCK CO. VARIOUS</b>	
F		<b>PIERCE MFG. INC. VARIOUS</b>	
<b>89410</b>	C		<b>401754 (4)</b>
R	96-98	FORD A9513	All Models with 21000 lb or 23000 lb Axle and 46" Taperleaf spring
R	97	A9522	All Models with 21000 lb or 23000 lb Axle and 46" Taperleaf spring
R	96-98	AT9513	All Models with 21000 lb or 23000 lb Axle and 46" Taperleaf spring
R	97-98	AT9522	All Models with 21000 lb or 23000 lb Axle and 46" Taperleaf spring
R	94-97	B - SERIES - BUS COWL CHASSIS	
R	94-97	F-800	All Models with 21000 Taperleaf Springs
R	94-98	FT900	All Models with 46" Taperleaf Springs and 21000 lb Axle
R	94-97	L8000F	All Models with 21000 or 23000 lb. with 46" Taperleaf Spring
R	94-97	L9000	All Models with 21000 or 23000 lb. with 46" Taperleaf Spring
R	94-97	LN7000	All Models with 21000 or 23000 lb. with 46" Taperleaf Spring
R	94-97	LN8000	All Models with 21000 or 23000 lb. with 46" Taperleaf Spring
R	94-97	LN9000	All Models with 21000 or 23000 lb. with 46" Taperleaf Spring
R	94-97	LNT8000F	All Models with 21000 or 23000 lb. with 46" Taperleaf Spring
R	94-97	LNT9000	All Models with 21000 or 23000 lb. with 46" Taperleaf Spring
R	94-97	LT9000	All Models with 21000 or 23000 lb. with 46" Taperleaf Spring
F	18-19	<b>KENWORTH C500</b>	All Models with Taper Leaf Springs on Front Axle
F	85-16	C500	All Models with Taper Leaf Springs on Front Axle
F	92-93	C540	All Models with Taper Leaf Springs on Front Axle
F	88-90	C540	All Models with Taper Leaf Springs on Front Axle

## 89000 Series

Shock	POP	Alternative No.	MTG Acc. Supplied
Pos.	Year	Application	
<b>89410</b>	C	(cont)	<b>401754 (4)</b>
F	85-94	C550	All Models with Taper Leaf Springs on Front Axle
F	16-17	ICON 900	
F	05-06	K100E	All Models with Taper Leaf Springs on Front Axle
F	85-03	K100E	All Models with Taper Leaf Springs on Front Axle
F	93-05	K300	All Models with Taper Leaf Springs on Front Axle (1" Mounting bolts)
F		T300	
F	10-22	T400	All Models with Taper Leaf Springs on Front Axle
F	89-99	T400	All Models with Taper Leaf Springs on Front Axle
F	93-97	T450	All Models with Taper Leaf Springs on Front Axle
F	86-08	T600A	All Models with Taper Leaf Springs on Front Axle
F	10-22	T800	All Models with Taper Leaf Springs on Front Axle
F	87-99	T800	All Models with Taper Leaf Springs on Front Axle
F	97-11	T2000	All Models with Taper Leaf Springs on Front Axle
F	10-24	W900	All Models with Taper Leaf Springs on Front Axle
F	87-99	W900	All Models with Taper Leaf Springs on Front Axle
F	89-05	<b>MACK CH</b>	All CH600 Models with ST34 Suspension
F	91-07	CL	All CL600, CL700 Models with ST34 Suspension
F	83-94	MH	All MH Models with O.E.M. Number
F	83-85	R	All RD Models with ST34 Suspension
F	85-93	RW	All RW Models with O.E.M. Number
R		<b>TUTHILL TECHNOLOGIIES TRAILER</b>	
<b>89411</b>	W		
R		<b>IC CORPORATION RE SCHOOL BUS</b>	
R		<b>INTERNATIONAL F &amp; S SERIES</b>	
R		<b>SERIES 1000 FORWARD CONTROL CHASSIS</b>	
R		<b>SERIES 2000 - CONVENTIONAL TRUCK (SEVERE SERVICE)</b>	
R		<b>SERIES 3000 - SCHOOL BUS CHASSIS</b>	
R		<b>SERIES 4000 - SHORT CONVENTIONAL MEDIUM TRK &amp; TRAC</b>	
R		<b>SERIES 7000 - SHORT CONV. MEDIUM TRUCK &amp; TRACTOR</b>	
R		<b>SERIES 8000 - CONVENTIONAL HEAVY DUTY TRACTOR</b>	
R		<b>SERIES 9100, 9100I - TRACTOR &amp; STRAIGHT TRUCK</b>	
R		<b>SERIES 9200, 9200I - TRACTOR &amp; STRAIGHT TRUCK</b>	
R		<b>SERIES 9300, 9300I, 9400 &amp; 9400I LONG HOOD CONV.</b>	
R		<b>SERIES 9600 &amp; 9700 PREMIUM CABOVER TRACTOR</b>	
R		<b>SERIES 9800 - PREMIUM CABOVER TRACTOR</b>	
R		<b>SERIES 9900, 9900I, 9900IX LONG HOOD CONV. TRUCK</b>	
R		<b>S SERIES SCHOOL BUS</b>	
<b>89413</b>	W		<b>145080 (2)</b>
F		<b>BLUE BIRD ADDITIONAL APPLICATIONS</b>	
F		<b>BROCKWAY SCHOOL BUS VARIOUS</b>	
F		<b>CHANCE COACH TRANSIT BUS VARIOUS</b>	
F	57-76	<b>FORD MOTORHOME CHASSIS</b>	
F		<b>INTERNATIONAL A, B, AC AND BC CONVENTIONAL</b>	
R		<b>A, B, AC AND BC CONVENTIONAL LOADSTAR - CONVENTIONAL</b>	
F		<b>LOADSTAR - CONVENTIONAL METRO &amp; MULTI-SHOP SERIES</b>	
R		<b>METRO &amp; MULTI-SHOP SERIES S SERIES SCHOOL BUS</b>	
R		<b>S SERIES SCHOOL BUS</b>	
R	85	<b>ISUZU ADDITIONAL APPLICATIONS</b>	

## Numerical listing

Shock	POP	Alternative No.	MTG Acc. Supplied
Pos.	Year	Application	
<b>89413</b>	W	(cont)	<b>145080 (2)</b>
F	19-24	<b>KENWORTH W990</b>	All Models with 14,600 lb Taperleaf Front Spring Suspension
F	13	<b>PETERBILT 220</b>	All Models with 12,000 lb Front Axle
F	10	220	All Models with 12,000 lb Front Axle
F	07	220	All Models with 12,000 lb Front Axle
F	07-16	330	All Models with 12000 lb Set Back Front Axle
F	95-05	330	All Models with 12000 lb Set Back Front Axle
F	05-10	335	All Models with 12000 lb Set Back Front Axle
F	07-10	340	All Models with 12000 lb Set Back Front Axle
F	87-08	357	All Conventional Models with Spring Suspension and with Set Back Front Axle.
F	81-06	362	All C.O.E. Models with Progressive Springs
F	08-15	365	All Models with 12,000 lb to 16,000 lb Taperleaf Front Suspension (Set-Back Axle)
F	08-16	367	All Models with 10,000 lb to 16,000 lb Taperleaf Front Spring Suspension and with Set Back Front Axle.
F	89-93	372	All C.O.E. Models with Front Spring Suspension
F	87-96	375	All Conventional Models with Spring Suspension and with Set Back Front Axle.
F	99	376	All Conventional Models with Spring Suspension and with Set Back Front Axle.
F	94-96	376	All Conventional Models with Spring Suspension and with Set Back Front Axle.
F	88-92	376	All Conventional Models with Spring Suspension and with Set Back Front Axle.
F	87-01	377	All Conventional Models with Spring Suspension and with Set Back Front Axle.
F	88-07	378	All Conventional Models with Spring Suspension and with Set Back Front Axle.
F	86-07	379	All Conventional Models with Spring Suspension and with Set Back Front Axle.
F	95-07	385	All Conventional Models with Spring Suspension and with Set Back Front Axle.
F	06-16	386	All Conventional Models with Spring Suspension and with Set Back Front Axle.
F	00-11	387	All Conventional Models with Spring Suspension and with Set Back Front Axle.
F	08-15	388	All Conventional Models with Spring Suspension and with Set Back Front Axle.
F	08-21	389	All Conventional Models with Spring Suspension and with Set Back Front Axle.
<b>89414</b>	W		
R		<b>ADVANCE MIXER VARIOUS</b>	
R		<b>BLUE BIRD ADDITIONAL APPLICATIONS</b>	
R	66-72	<b>CHEVROLET 7, 70 &amp; 7000 SERIES</b>	
F	09	<b>COACHMEN AURORA</b>	
F	07	AURORA	
F	99-07	MIRADA	
F	04-12	PURSUIT	
F	00-14	<b>DAMON CHALLENGER</b>	All MotorHomes with Ford F53 Chassis with 16,000 lb GVW to 22,000 lb GVW
F	12-13	DAYBREAK	
F	99	DAYBREAK	
F	00-11	DAYBREAK	All MotorHomes with Ford F53 Chassis with 16,000 lb GVW to 22,000 lb GVW
F	99	INTRUDER	
F	00-07	INTRUDER	All MotorHomes with Ford F53 Chassis with 16,000 lb GVW to 22,000 lb GVW
F	12-14	OUTLAW	
F	07-11	OUTLAW	All MotorHomes with Ford F53 Chassis with 16,000 lb GVW to 22,000 lb GVW



# Numerical listing

Shock	POP	Alternative No.	MTG Acc. Supplied
Pos.	Year	Application	
<b>89414</b>	W	(cont)	
F	19-24	<b>ENTEGR COACH</b> EMBLEM All MotorHomes with Ford F53 Chassis with 16,000 lb GVW to 22,000 lb GVW	
F	19-24	<b>VISION</b> All MotorHomes with Ford F53 Chassis with 16,000 lb GVW to 22,000 lb GVW	
F	19-20	<b>FLEETWOOD AXON</b>	
F	18	<b>AXON</b> All MotorHomes with Ford F53 Chassis with 16,000 lb GVW to 22,000 lb GVW	
F	00-24	<b>BOUNDER</b> All MotorHomes with Ford F53 Chassis with 16,000 lb GVW to 22,000 lb GVW	
F	15-24	<b>FLAIR</b> All MotorHomes with Ford F53 Chassis with 16,000 lb GVW to 22,000 lb GVW	
F	00-07	<b>FLAIR</b> All MotorHomes with Ford F53 Chassis with 16,000 lb GVW to 22,000 lb GVW	
F	23-24	<b>FLEX</b> All MotorHomes with Ford F53 Chassis with 16,000 lb GVW to 22,000 lb GVW	
F	20-24	<b>FORTIS</b> All MotorHomes with Ford F53 Chassis with 16,000 lb GVW to 22,000 lb GVW	
F	00-23	<b>SOUTHWIND</b> All MotorHomes with Ford F53 Chassis with 16,000 lb GVW to 22,000 lb GVW	
F	11-18	<b>STORM</b> All MotorHomes with Ford F53 Chassis with 16,000 lb GVW to 22,000 lb GVW	
F	01-07	<b>STORM</b> All MotorHomes with Ford F53 Chassis with 16,000 lb GVW to 22,000 lb GVW	
R	96-98	<b>FORD A9513</b> All All with Hendrickson HA-400, HA-210 or HA-230 Air Suspension	
R	97	<b>A9522</b> All All with Hendrickson HAS-400, HA-210 or HA-230 Air Suspension	
R	96-98	<b>AT9513</b> All All with Hendrickson HAS-400, HA-210 or HA-230 Air Suspension	
R	97-98	<b>AT9522</b> All All with Hendrickson HAS-400, HA-210 or HA-230 Air Suspension	
R	81-91	<b>CL9000</b> All Models with Single Rear Axle Suspension	
R	78-80	<b>CL &amp; CLT SERIES - HIGHWAY TRACTOR TILT CAB</b>	
R	81-91	<b>CLT9000</b> All Models with Single Rear Axle Suspension	
F	06-23	<b>F-53</b>	
F	99-04	<b>F-53</b>	
F	88-97	<b>F-53</b>	
F	25	<b>F-53 MOTORHOME CHASSIS</b>	
F	05	<b>F-53 MOTORHOME CHASSIS</b>	
F	98	<b>F-53 MOTORHOME CHASSIS</b>	
F	06-24	<b>F-53 MOTORHOME CHASSIS</b> All F53 Chassis with 16,000 lb GVW to 22,000 lb GVW	
F	11-20	<b>F-53 MOTORHOME CHASSIS</b> All F53 Stripped Chassis Commercial Stripped Chassis, 19,500 lb to 22,000 lb GVW	
F	99-04	<b>F-53 MOTORHOME CHASSIS</b> All F53 Chassis with 16,000 lb GVW to 22,000 lb GVW	
F	88-97	<b>F-53 MOTORHOME CHASSIS</b> All F53 Chassis with 16,000 lb GVW to 22,000 lb GVW	
F	88	<b>F-59 COMMERCIAL STRIPPED CHASSIS</b> All F59 Commercial Chassis with 16,000 lb to 22,000 GVW	
R	91-97	<b>LA8000F</b> All All with Hendrickson HAS-400, HA-210 or HA-230 Air Suspension	
R	91-97	<b>LA9000</b> All All with Hendrickson HAS-400, HA-210 or HA-230 Air Suspension	
R	92-97	<b>LLA9000</b> All Models with Hendrickson Rear Air Suspension	
R		<b>LOUISVILLE SERIES - CONVENTIONAL CAB</b>	
R	91-97	<b>LTA9000</b> All Models with Hendrickson Rear Air Suspension	
R	92-97	<b>LTLA9000</b> All Models with Hendrickson Rear Air Suspension	
R	73-77	<b>W AND WT SERIES - HI TILT CAB HIGHWAY TRACTOR</b>	
F	99-09	<b>GEORGIE BOY MANUFACTURING CLASS A MOTORHOMES</b>	

# 89000 Series

Shock	POP	Alternative No.	MTG Acc. Supplied
Pos.	Year	Application	
<b>89414</b>	W	(cont)	
R	66-72	<b>GMC 7500 SERIES</b>	
R		<b>HENDRICKSON TRAILER SUSPENSION SYSTEMS</b>	
		<b>UNDERSLUNG STYLE</b>	
F	11-15	<b>HOLIDAY RAMBLER ADMIRAL</b>	
F	02-06	<b>ADMIRAL</b>	
F	15	<b>ENDEAVOR</b>	
F	10	<b>VACATIONER</b>	
F	08	<b>VACATIONER</b>	
R		<b>INTERNATIONAL F &amp; S SERIES</b>	
R		<b>SERIES 4000 - SHORT CONVENTIONAL MEDIUM TRK &amp; TRAC</b>	
R		<b>SERIES 9300, 9300I, 9400 &amp; 9400I LONG HOOD CONV.</b>	
R		<b>SERIES 9600 &amp; 9700 PREMIUM CABOVER TRACTOR</b>	
R		<b>SERIES 9800 - PREMIUM CABOVER TRACTOR</b>	
R		<b>SERIES 9900, 9900I, 9900IX LONG HOOD CONV. TRUCK</b>	
F	99-15	<b>ITASCA CLASS A MOTORHOMES</b>	
F	14-20	<b>JAYCO CLASS A MOTORHOMES</b>	
F	81-03	<b>MACK DM</b> All DM Models	
F	01-06	<b>LE</b> All LE 613 Models with O.E.M Number	
F	09	<b>LEU</b> All LEU 613 Models with 18,000 lb Front Axle	
F	81-07	<b>MR</b> All MR600 Models with 20,000 lb Front Axle	
F	08-19	<b>MRU</b> All MRU613 Models with O.E.M. Number	
F	92-05	<b>RB</b> All RB 600 Models (Drive Axle)	
R		<b>MC NEILUS TRUCK &amp; MAN. VARIOUS</b>	
F	07-08	<b>MONACO COACH LA PALMA</b>	
F	01	<b>LA PALMA</b>	
F	90-99	<b>LA PALMA</b>	
F	12-13	<b>LA PALMA</b> All MotorHomes with Ford F53 Chassis with 16,000 lb GVW to 22,000 lb GVW	
F	09	<b>LA PALMA</b> All MotorHomes with Ford F53 Chassis with 16,000 lb GVW to 22,000 lb GVW	
F	02-06	<b>LA PALMA</b> All MotorHomes with Ford F53 Chassis with 16,000 lb GVW to 22,000 lb GVW	
F	00	<b>LA PALMA</b> All MotorHomes with Ford F53 Chassis with 16,000 lb GVW to 22,000 lb GVW	
F	03-05	<b>MONARCH</b>	
F	90-99	<b>MONARCH</b>	
F	06-14	<b>MONARCH</b> All MotorHomes with Ford F53 Chassis with 16,000 lb GVW to 22,000 lb GVW	
F	01-02	<b>MONARCH</b> All MotorHomes with Ford F53 Chassis with 16,000 lb GVW to 22,000 lb GVW	
F	99-08	<b>NATIONAL RV CLASS A MOTORHOMES</b>	
F	13-20	<b>NEWMAR CLASS A MOTORHOMES</b>	
F	16-20	<b>NEXUS CLASS A MOTORHOMES</b>	
R	13-22	<b>PETERBILT 220</b> All Models with Reyco 102AR (Standard) Rear Air Suspension	
R	10	<b>220</b> All Models with Reyco 102AR (Standard) Rear Air Suspension	
R	07	<b>220</b> All Models with Reyco 102AR (Standard) Rear Air Suspension	
R	87-18	<b>320</b> All Models with Reyco 102AR (Standard) Rear Air Suspension	
R	07-21	<b>330</b> All Models with Reyco 102AR (Standard) Rear Air Suspension	
R	95-05	<b>330</b> All Models with Reyco 102AR (Standard) Rear Air Suspension	
R	10-21	<b>337</b> All Models with Reyco 102AR (Standard) Rear Air Suspension	
R	10-21	<b>348</b> All Models with Reyco 102AR (Standard) Rear Air Suspension	
F	86-08	<b>357</b> All Conventional Models with Front Air Suspension and Set Back Front Axle.	
R	10-19	<b>365</b> All Models with Reyco 102AR (Standard) Rear Air Suspension	
F	89-93	<b>372</b> All C.O.E. Models with Front Air Suspension	
F	87-96	<b>375</b> All Conventional Models with Front Air Suspension and Set Back Front Axle.	
F	99	<b>376</b> All Conventional Models with Front Air Suspension and Set Back Front Axle.	

# Numerical listing

Shock	POP	Alternative No.	MTG Acc. Supplied
Pos.	Year	Application	
<b>89414</b>	W	(cont)	
F	94-96	<b>376</b> All Conventional Models with Front Air Suspension and Set Back Front Axle.	
F	88-92	<b>376</b> All Conventional Models with Front Air Suspension and Set Back Front Axle.	
F	87-01	<b>377</b> All Conventional Models with Front Air Suspension and Set Back Front Axle.	
F	88-07	<b>378</b> All Conventional Models with Front Air Suspension and Set Back Front Axle.	
F	86-07	<b>379</b> All Conventional Models with Front Air Suspension and Set Back Front Axle.	
R	11-17	<b>382</b> All Models with Reyco 102AR (Standard) Rear Air Suspension	
F	06-16	<b>386</b> All Conventional Models with Front Air Suspension and Set Back Front Axle.	
F	00-11	<b>387</b> All Conventional Models with Front Air Suspension and Set Back Front Axle.	
F	08-15	<b>388</b> All Conventional Models with Front Air Suspension and Set Back Front Axle.	
F	08-22	<b>389</b> All Conventional Models with Front Air Suspension and Set Back Front Axle.	
R	17-22	<b>520</b> All Models with Reyco 102AR (Standard) Rear Air Suspension	
R	13-22	<b>579</b> All Models with Reyco 102AR (Standard) Rear Air Suspension	
R	11-18	<b>587</b> All Models with Reyco 102AR (Standard) Rear Air Suspension	
R		<b>REYCO SUSPENSION DRIVE AXLE</b>	
R		<b>SAF HOLLAND TRAILER AIR SUSPENSION</b>	
R		<b>TRUCK, BUS &amp; MOTORHOME AIR SUSPENSIONS</b>	
R		<b>TRUCK &amp; TRACTOR AIR SUSPENSION (TAG AXLE)</b>	
R	91-92	<b>SPARTAN MOTORS</b>	
R		<b>MOTORHOME</b> All Models with Tuthill 102 AR Air Suspension	
R	93-95	<b>MOUNTAIN MASTER</b> All Models with Tuthill 102 AR Air Suspension	
R	99-10	<b>STERLING TRUCK A9500</b> All Models with Hendrickson HAS Rear Air Suspension	
R	99-01	<b>A9513</b> All Models with Hendrickson HAS Rear Air Suspension	
R	99	<b>A9522</b> All Models with Hendrickson HAS Rear Air Suspension	
R	99-10	<b>L8500</b> All Models with Hendrickson HAS Rear Air Suspension	
R	99	<b>L8501</b> All Models with Hendrickson HAS Rear Air Suspension	
R	99-01	<b>L8513</b> All Models with Hendrickson HAS Rear Air Suspension	
R	99-10	<b>L9500</b> All Models with Hendrickson HAS Rear Air Suspension	
R	99-00	<b>L9501</b> All Models with Hendrickson HAS Rear Air Suspension	
R	99-01	<b>L9511</b> All Models with Hendrickson HAS Rear Air Suspension	
R	99-00	<b>L9513</b> All Models with Hendrickson HAS Rear Air Suspension	
R	99	<b>L9522</b> All Models with Hendrickson HAS Rear Air Suspension	
F	05-08	<b>THOR MOTOR COACH CHALLENGER</b>	
F	04-10	<b>HURRICANE</b>	
F	07-10	<b>OUTLAW</b>	
F	06-10	<b>WINDSPORT</b>	
R		<b>TRAILMOBILE CANADA CORP. VARIOUS</b>	
R		<b>TUTHILL TECHNOLOGIES DRIVE AXLE</b>	
R	98	<b>WESTERN STAR 3800</b>	
R	99-01	<b>3800</b> All Models with Neway Rear Suspension	
R	89-97	<b>3800</b> All Models with Neway Rear Suspension	
R	89-02	<b>4800</b> All Models with Neway Rear Suspension	
R	89-02	<b>4900</b> All Models with Neway Rear Suspension	
R	97-02	<b>5800</b> All Models with Neway Rear Suspension	
R	89-01	<b>5900</b> All Models with Neway Rear Suspension	

## Numerical listing

Shock	POP	Alternative No.	MTG Acc. Supplied
Pos.	Year	Application	
<b>89414</b>	W	(cont)	
R	89-01	6900	All Models with Neway Rear Suspension
F	23	<b>WINNEBAGO SUNSTAR NPF</b>	
F	23	VISTA NPF	
<b>89415</b>	W	<b>140149 (1)</b>	
R	<b>VOLVO FE SERIES</b>		
<b>89419</b>	W	<b>401754 (4)</b>	
R	<b>FRUEHAUF</b> VARIOUS		
R	<b>HOBBS TRAILER</b> VARIOUS		
R	<b>INTERNATIONAL CARGOSTAR</b>		
R	CO-TRANSTAR AND TRANSTAR II		
R	FLEETSTAR - CONVENTIONAL		
R	LOADSTAR - CONVENTIONAL		
R	TRANSTAR - CONVENTIONAL		
F	<b>OSTERLUND TRUCK</b> VARIOUS		
F	<b>OTTAWA</b> VARIOUS		
R	<b>REYCO SUSPENSION TRAILER</b>		
R	<b>SAF HOLLAND TRUCK, BUS &amp; MOTORHOME AIR SUSPENSIONS TRUCK &amp; TRACTOR AIR SUSPENSION (TAG AXLE)</b>		
R	<b>SEAGRAVE FIRE APPARATUS LLC</b> VARIOUS		
R	<b>TUTHILL TECHNOLOGIES</b> TRAILER		
R	<b>WABASH NATIONAL</b> VARIOUS		
R	<b>WATSON &amp; CHALIN MFG. INC.</b> LIGHT WEIGHT TRAILER AIR SUSPENSION		
R	<b>WESTERN UNIT STABILAIR SUSPENSION</b> VARIOUS		
<b>89420</b>	W	<b>401754 (4)</b>	
R	<b>AM GENERAL</b> VARIOUS		
F	66-69	<b>CHEVROLET 8, 80 &amp; 8000 SERIES</b>	
R	86-97	<b>FORD CF7000</b> All Models with 12000 lb or 13000 lb Axle	
R	87-97	<b>CF8000</b> All Models with 12000 lb or 13000 lb Axle	
F	<b>FREIGHTLINER</b>		
F	CLASSIC/CLASSICXL		
F	<b>FWD CORPORATION</b> VARIOUS		
F	66-72	<b>GMC 8500 SERIES</b>	
F	66-72	9500 SERIES	
F	<b>MACK F SERIES</b>		
F	84-87	<b>PETERBILT 349</b> All 349 Conventional Models with 12000 lb capacity	
F	81-88	353 All 353 Conventional Models with 12000 lb capacity	
F	81-87	359 All 359 Conventional Models with 12000 lb capacity	
F	81-06	362 All C.O.E. Models without Set Back Front Axle	
R	<b>RIDEWELL CORP. TRUCK AIR-RIDES</b>		
<b>89422</b>	W	<b>401754 (4)</b>	
F	<b>ACF BRILL BUS</b> VARIOUS		
F	<b>BROCKWAY SCHOOL BUS</b> VARIOUS		
F	<b>BUILT RITE</b> VARIOUS		
F	<b>BUS &amp; TRUCK CO.</b> VARIOUS		
F	73-80	<b>CHEVROLET 7, 70 &amp; 7000 SERIES</b>	
R	73-80	7, 70 & 7000 SERIES	
R	73-80	8, 80 & 8000 SERIES	
F	70-80	8, 80 & 8000 SERIES	
F	70-80	9000 SERIES	
F	<b>CONTINENTAL TRAILWAYS-EAGLE INTL.</b> VARIOUS		
F	<b>CROWN COACH</b> VARIOUS		
F	<b>EAGLE MOTOR COACH</b> VARIOUS		
F	<b>FREIGHTLINER</b>		
F	CLASSIC/CLASSICXL		
R	73-80	<b>GMC 7500 SERIES</b>	
F	70-80	7500 SERIES	
F	73-80	8500 SERIES	
R	73-80	8500 SERIES	
F	66-80	9500 SERIES	
F	<b>GREYHOUND BUS</b> VARIOUS		
F	<b>INTERNATIONAL CO-TRANSTAR AND TRANSTAR II</b>		
F	F & S SERIES		
F	LOADSTAR - CONVENTIONAL		
F	PAYSTAR - 5000 SERIES		
F	S SERIES SCHOOL BUS		
F	TRANSTAR - CONVENTIONAL		
F	UNISTRAR		
F	<b>MC NEILUS TRUCK &amp; MAN.</b> VARIOUS		
F	<b>ORION BUS</b> VARIOUS		
R	VARIOUS		

## 89000 Series

Shock	POP	Alternative No.	MTG Acc. Supplied
Pos.	Year	Application	
<b>89422</b>	W	(cont)	
F	<b>OSHKOSH MOTOR TRUCK CO.</b>		
R	VARIOUS		
F	<b>PETERBILT 362</b>		
F	<b>TRANSPORTATION MFG. CORP.</b>		
R	VARIOUS		
R	<b>VOLVO ADDITIONAL APPLICATIONS</b>		
F	<b>WESTERN STAR 5900 &amp; 6900 SERIES - HERITAGE CLASS</b>		
R	<b>WESTERN UNIT STABILAIR SUSPENSION</b> VARIOUS		
<b>89423</b>	W	<b>141108 (1)</b>	
R	<b>INTERNATIONAL</b> VARIOUS		
R	<b>KENWORTH C500, C500B, C500K, C540 &amp; C550</b>		
R	K100, K100E, K125		
R	93-05	K300 All All with Air Glide 100 Suspension with 8 air bags, 4 units required	
R	T300		
R	T400, T400B, T450B		
R	T600, T600A, T600B, T602		
R	T800, T800B, T800B(8X4), T800SH, T800H, T800W		
R	97-11	T2000 All All with Air Glide 100 Suspension with 8 air bags, 4 units required	
R	W900, W900B, W900L, W900S		
R	<b>OTTAWA</b> VARIOUS		
<b>89424</b>	B	<b>141247 (1)</b>	
F	<b>INTERNATIONAL</b>		
R	SERIES400,500,600,700& 900-MED CABOV TRK&TRAC NISS		
R	VARIOUS		
R	<b>LEYLAND TRUCK</b> VARIOUS		
R	87-18	<b>PETERBILT 320</b> All Models with Air Trac Suspension (46,000 lb)	
R	07-21	330 All Models with Air Trac Suspension (46,000 lb)	
R	95-05	330 All Models with Air Trac Suspension (46,000 lb)	
R	05-10	335 All Models with Air Trac Suspension (46,000 lb)	
R	10-23	337 All Models with Air Trac Suspension (46,000 lb)	
R	07-10	340 All Models with Air Trac Suspension (46,000 lb)	
R	10-23	348 All Models with Air Trac Suspension (46,000 lb)	
R	87-08	357 All Models with Air Trac Suspension (46,000 lb)	
R	81-87	359 All Models with Air Trac Suspension (46,000 lb)	
R	81-06	362 All Models with Air Trac Suspension (46,000 lb)	
R	08-23	365 All Models with Air Trac Suspension (46,000 lb)	
R	08-24	367 All Models with Air Trac Suspension (46,000 lb)	
R	89-93	372 All Models with Air Trac Suspension (46,000 lb)	
R	87-96	375 All Models with Air Trac Suspension (46,000 lb)	
R	02	376	
R	00	376	
R	99	376 All Models with Air Trac Suspension (46,000 lb)	
R	94-96	376 All Models with Air Trac Suspension (46,000 lb)	
R	88-92	376 All Models with Air Trac Suspension (46,000 lb)	
R	87-01	377 All Models with Air Trac Suspension (46,000 lb)	
R	88-07	378 All Models with Air Trac Suspension (46,000 lb)	
R	86-07	379 All Models with Air Trac Suspension (46,000 lb)	
R	11-17	382 All Models with Air Trac Suspension (46,000 lb)	
R	08-16	384 All Models with Air Trac Suspension (46,000 lb)	
R	95-07	385 All Models with Air Trac Suspension (46,000 lb)	
R	06-16	386 All Models with Air Trac Suspension (46,000 lb)	
R	06-16	386 All Models with Peterbilt Air Leaf Suspension	
R	00-11	387 All Models with Peterbilt Air Leaf Suspension	
R	08-15	388 All Models with Air Trac Suspension (46,000 lb)	

## Numerical listing

Shock	POP	Alternative No.	MTG Acc. Supplied
Pos.	Year	Application	
<b>89424</b>	B	(cont)	
R	08-15	388 All Models with Peterbilt Air Leaf Suspension	
R	14-24	389 All Models with Air Trac Suspension (46,000 lb)	
R	08-13	389 All Models with Peterbilt Air Leaf Suspension	
R	17-23	520 All Models with Air Trac Suspension (46,000 lb)	
R	14-24	567 All Models with Air Trac Suspension (46,000 lb)	
R	13-24	579 All Models with Air Trac Suspension (46,000 lb)	
R	11-18	587 All Models with Air Trac Suspension (46,000 lb)	
<b>89425</b>	W	<b>401754 (4)</b>	
R	08-20	<b>AUTOCAR LLC.</b> XPEDITOR All 8 X 4 Models with Chalmers 800 Series - 46K Tandem Truck Suspensions ( HD Shock Kit with Low Mounts)	
R	<b>CHALMERS SUSPENSION</b> VARIOUS		
F	<b>EAGLE MOTOR COACH</b> VARIOUS		
R	96-98	<b>FORD A9513</b> All All with 23000 lb Axle and 52" Taperleaf spring	
R	97	A9522 All All with 23000 lb Axle and 52" Taperleaf spring	
R	96-98	AT9513 All All with 23000 lb Axle and 52" Taperleaf spring	
R	97-98	AT9522 All All with 23000 lb Axle and 52" Taperleaf spring	
R	94	B-700 All Models with 15000, 17500, 19000 lb Taperleaf Springs	
R	95-97	B-800 All Models with 15000, 17500, 19000 lb Taperleaf Springs	
R	94-98	F-700 All Models with 15000, 17500, 19000 lb Taperleaf Springs	
R	94-98	F-800 All Models with 15000, 17500, 19000 lb Taperleaf Springs	
R	94-98	FT900 All Models with 46" Taperleaf Spring and 15000, 17500 or 19000 lb Axle	
R	<b>KENWORTH C500, C500B, C500K, C540 &amp; C550</b>		
R	K100, K100E, K125		
R	T400, T400B, T450B		
R	T800, T800B, T800B(8X4), T800SH, T800H, T800W		
R	W900, W900B, W900L, W900S		
R	99-10	<b>STERLING TRUCK A9500</b> All All Models with 23000 lb Axle and 52" Taperleaf Softride Rear Suspension	
R	99-01	A9513 All All Models with 23000 lb Axle and 52" Taperleaf Softride Rear Suspension	
R	99	A9522 All All Models with 23000 lb Axle and 52" Taperleaf Softride Rear Suspension	
R	99-10	L8500 All All Models with 23000 lb Axle and 52" Taperleaf Softride Rear Suspension	
R	99	L8501 All All Models with 23000 lb Axle and 52" Taperleaf Softride Rear Suspension	
R	99-00	L8511 All All Models with 23000 lb Axle and 52" Taperleaf Softride Rear Suspension	
R	99-01	L8513 All All Models with 23000 lb Axle and 52" Taperleaf Softride Rear Suspension	
R	99-10	L9500 All All Models with 23000 lb Axle and 52" Taperleaf Softride Rear Suspension	
R	99-00	L9501 All All Models with 23000 lb Axle and 52" Taperleaf Softride Rear Suspension	
R	99-01	L9511 All All Models with 23000 lb Axle and 52" Taperleaf Softride Rear Suspension	
R	99-00	L9513 All All Models with 23000 lb Axle and 52" Taperleaf Softride Rear Suspension	
R	99	L9522 All All Models with 23000 lb Axle and 52" Taperleaf Softride Rear Suspension	
<b>89426</b>	W	<b>145090 (1)</b>	
F	10-11	<b>INTERNATIONAL PAYSTAR - 5000 SERIES</b>	
F	SERIES 2000 - CONVENTIONAL TRUCK (SEVERE SERVICE)		
F	90-02	SERIES 4000 - SHORT CONVENTIONAL MEDIUM TRK & TRAC	

Numerical listing

Shock	POP	Alternative No.	MTG Acc. Supplied
Pos.	Year	Application	
<b>89426</b>	W	(cont)	<b>145090 (1)</b>
F		SERIES 8000 - CONVENTIONAL HEAVY DUTY TRACTOR	
F		SERIES 9100, 9100I - TRACTOR & STRAIGHT TRUCK	
F		SERIES 9200, 9200I - TRACTOR & STRAIGHT TRUCK	
F		SERIES 9300, 9300I, 9400 & 9400I LONG HOOD CONV.	
F		SERIES 9600 & 9700 PREMIUM CABOVER TRACTOR	
F		SERIES 9800 - PREMIUM CABOVER TRACTOR	
F		SERIES 9900, 9900I, 9900IX LONG HOOD CONV. TRUCK	
F		VARIOUS	
F		<b>OSHKOSH MOTOR TRUCK CO.</b>	
F		VARIOUS	
F		<b>PIERCE MFG. INC.</b> VARIOUS	
<b>89427</b>	D		<b>145099 (1)</b>
R		<b>INTERNATIONAL</b> VARIOUS	
R	95-02	<b>PETERBILT 330</b> All Models with Peterbilt 40000 lb Low Air Leaf Suspension	
R	87-01	357 All Models with Peterbilt Low Air Leaf Suspension	
R	81-01	362 All Models with Peterbilt Low Air Leaf Suspension	
R	89-93	372 All Models with Peterbilt Low Air Leaf Suspension	
R	87-96	375 All Models with Peterbilt Low Air Leaf Suspension	
R	99	376 All Models with Peterbilt Low Air Leaf Suspension	
R	94-96	376 All Models with Peterbilt Low Air Leaf Suspension	
R	88-92	376 All Models with Peterbilt Low Air Leaf Suspension	
R	87-01	377 All Models with Peterbilt Low Air Leaf Suspension	
R	88-02	378 All Models with Peterbilt Low Air Leaf Suspension	
R	86-02	379 All Models with Peterbilt Low Air Leaf Suspension	
R	95-02	385 All Models with Peterbilt Low Air Leaf Suspension	
R	00-02	387 All Models with Peterbilt Low Air Leaf Suspension	
<b>89428</b>	W		<b>145089-000 (1)</b>
R	89-99	<b>FREIGHTLINER</b> FLA086 All Models with Airliner Rolling Lobe Spring Air Suspension	
R	02	FLB All Models with Airliner Rolling Lobe Spring Air Suspension	
R	94-99	FLB All Models with Airliner Rolling Lobe Spring Air Suspension	
R		<b>INTERNATIONAL</b> VARIOUS	
<b>89429</b>	W		<b>401754 (4)</b>
F		<b>FREIGHTLINER</b>	
F	89-99	CLASSIC/CLASSICXL FLA086 All Models with O.E.M. Number	
F	94-99	FLB All Models with O.E.M. Number	
F	85-97	FLC112 All Models with O.E.M. Number	
F	91	FLC120 All Models with O.E.M. Number	
F	87-88	FLC120 All Models with O.E.M. Number	
F	91-08	FLD112 All Models with O.E.M. Number	
F	88-11	FLD120 All Models with O.E.M. Number	
F	05-12	FLD120SD All Models with O.E.M. Number	
F	03	FLD120SD All Models with O.E.M. Number	
F	03-11	FLD132 All Models with O.E.M. Number	
F	01	FLD132 All Models with O.E.M. Number	
<b>89430</b>	C		
F		<b>AUTOCAR LLC.</b> ADDITIONAL APPLICATIONS	
R		<b>BLUE BIRD</b> ADDITIONAL APPLICATIONS	
R		ALL AMERICAN SERIES (FE & RE MODELS)	
R		<b>BOYDSTUN EQUIPMENT</b>	
R		<b>MANUFACTURING</b> VARIOUS	
R	71-89	<b>CHEVROLET</b> 6, 60, 6000 & 6500 SERIES	

89000 Series

Shock	POP	Alternative No.	MTG Acc. Supplied
Pos.	Year	Application	
<b>89430</b>	C	(cont)	
F	73-80	6, 60, 6000 & 6500 SERIES	
F	68-69	6, 60, 6000 & 6500 SERIES	
R	79-89	7, 70 & 7000 SERIES	
F	66-80	7, 70 & 7000 SERIES	
R		<b>CUSH CORPORATION</b> VARIOUS	
R		<b>EAST MANUFACTURING CORP.</b> VARIOUS	
R	19-23	<b>INTEGRA COACH</b> EMBLEM All MotorHomes with Ford F53 Chassis with 24,000 lb GVW to 26,000 lb GVW	
R	20-23	VISION XL All MotorHomes with Ford F53 Chassis with 24,000 lb GVW to 26,000 lb GVW	
R	08-23	<b>FLEETWOOD BOUNDER</b> All MotorHomes with Ford F53 Chassis with 24,000 lb GVW to 26,000 lb GVW	
R	20-23	FORTIS All MotorHomes with Ford F53 Chassis with 24,000 lb GVW to 26,000 lb GVW	
R	08-23	SOUTHWIND All MotorHomes with Ford F53 Chassis with 24,000 lb GVW to 26,000 lb GVW	
R	08-23	FORD F-53	
R	08-23	F-53 MOTORHOME CHASSIS All MotorHomes with Ford F53 Chassis with 24,000 lb GVW to 26,000 lb GVW	
F		<b>FREIGHTLINER</b> BUS CHASSIS	
R	05-06	M2 106 All Models with Reycy 79KB Rear Steel Spring Suspension	
R	02-03	M2 106 All Models with Reycy 79KB Rear Steel Spring Suspension	
F		VARIOUS	
R		<b>GILLIG</b> VARIOUS	
F	79-80	<b>GMC</b> 6000 SERIES	
F	63-68	6000 SERIES	
F	66-80	6500 SERIES	
R	66-80	6500 SERIES	
R	79-89	7000 SERIES	
F	79-80	7000 SERIES	
F	66-80	7500 SERIES	
R		<b>HENDRICKSON TRAILER</b>	
R		<b>SUSPENSION SYSTEMS</b>	
R		ADDITIONAL APPLICATIONS	
R		INTRAAX	
R		TOP MOUNT STYLE	
R		UNDERSLUNG STYLE	
R		VANTRAAX	
R	00-09	<b>INTERNATIONAL</b> 5900I All Models with 46,000 lb Neway Rear Air Suspension	
R		SERIES 5000, 5000I -SEVERE SERVICE CONV TRK & TRAC	
R		SERIES 8000 - CONVENTIONAL HEAVY DUTY TRACTOR	
R		SERIES 9100, 9100I - TRACTOR & STRAIGHT TRUCK	
R		SERIES 9200, 9200I - TRACTOR & STRAIGHT TRUCK	
R		SERIES 9300, 9300I, 9400 & 9400I LONG HOOD CONV.	
R		SERIES 9600 & 9700 PREMIUM CABOVER TRACTOR	
R		SERIES 9800 - PREMIUM CABOVER TRACTOR	
R		SERIES 9900, 9900I, 9900IX LONG HOOD CONV. TRUCK	
R	93-05	<b>KENWORTH</b> K300 All Models with Reycy 102 or 79KB Suspension (Drive Axle)	
F	93-05	K300 All Models with Reycy 1209 or 1212 Suspension (Steer Axle)	
R	13-24	K370 All Models with Reycy 102 or 79KB Suspension (Drive Axle)	
F		T300	
R		T300	
R	01-08	T300 All Models with Reycy 102 or 79KB Suspension (Drive Axle)	
R	01-08	T300 All Models with Reycy 1209 or 1212 Suspension (Steer Axle)	
R	99	T300 All Models with Reycy 102 or 79KB Suspension (Drive Axle)	
R	99	T300 All Models with Reycy 1209 or 1212 Suspension (Steer Axle)	
R	08-23	T370 All Models with Reycy 102 or 79KB Suspension (Drive Axle)	
R	22-24	T380 All Models with Reycy 102 or 79KB Suspension (Drive Axle)	
R	12-21	T440	
R	10-21	T470	
F		T600, T600A, T600B, T602	
R		T600, T600A, T600B, T602	

Numerical listing

Shock	POP	Alternative No.	MTG Acc. Supplied
Pos.	Year	Application	
<b>89430</b>	C	(cont)	
R	13-22	T680 All Models with 21,000 to 23,000 lb Reycy Spring Suspension	
R	13-22	T680 All Models with Reycy 102 or 79KB Suspension (Drive Axle)	
R	87-24	T800 All Models with Reycy 102 or 79KB Suspension (Drive Axle)	
F	87-23	T800 All Models with Reycy 1209 or 1212 Suspension (Steer Axle)	
R	11-22	T880 All Models with Reycy 102 or 79KB Suspension (Drive Axle)	
R	06-22	W900 All Models with Reycy 102 or 79KB Suspension (Drive Axle)	
F		W900, W900B, W900L, W900S	
R		W900, W900B, W900L, W900S	
R	19-22	W990 All Models with Reycy 102 or 79KB Suspension (Drive Axle)	
F	89-05	<b>MACK</b> CH All CH600 Models with 12000 lb Taperleaf Spring	
F	91-07	CL All CL600, CL700 Models with Steering Axle & Taperleaf Spring	
F	98-05	CX All Models with 12000 lb Taperleaf Front Suspension	
F	83-94	MH All MH Models with O.E.M. Number	
F	85-93	RW All RW Models with O.E.M. Number	
R		<b>MC NEILUS TRUCK &amp; MAN.</b>	
R		VARIOUS	
R		<b>OSHKOSH MOTOR TRUCK CO.</b> VARIOUS	
R	13-24	<b>PETERBILT</b> 220 All Models with Reycy 102 or 79KB Suspension (Drive Axle)	
R	10	220 All Models with Reycy 102 or 79KB Suspension (Drive Axle)	
R	07	220 All Models with Reycy 102 or 79KB Suspension (Drive Axle)	
R	87-18	320 All Models with Reycy 102 or 79KB Suspension (Drive Axle)	
R	07-22	330 All Models with Reycy 79KB Rear Steel Spring Suspension	
R	95-05	330 All Models with Reycy 79KB Rear Steel Spring Suspension	
R	10-22	337 All Models with Reycy 79KB Rear Steel Spring Suspension	
R	10-23	348 All Models with Reycy 79KB Rear Steel Spring Suspension	
R	10-22	365 All Models with Reycy 79KB Rear Steel Spring Suspension	
R	11-17	382 All Models with Reycy 79KB Rear Steel Spring Suspension	
R	17-22	520 All Models with Reycy 79KB Rear Steel Spring Suspension	
R	22-24	537 All Models with Reycy 102 or 79KB Suspension (Drive Axle)	
R	13-24	579 All Models with Reycy 79KB Rear Steel Spring Suspension	
R	11-18	587 All Models with Reycy 79KB Rear Steel Spring Suspension	
R		<b>REYCO SUSPENSION</b> DRIVE AXLE	
F		STEER AXLE	
R		<b>RIDEWELL CORP.</b> TRAILER AIR-RIDES	
R		TRUCK AIR-RIDES	
R		<b>SAF HOLLAND</b> TRAILER AIR SUSPENSION	
R		TRUCK, BUS & MOTORHOME AIR SUSPENSIONS	
R		TRUCK & TRACTOR AIR SUSPENSION (TAG AXLE)	
F	96-00	<b>SAFARI MOTOR COACH</b> CLASS A MOTORHOMES	
R	96-00	CLASS A MOTORHOMES	
R		<b>TUTHILL TECHNOLOGIES</b> DRIVE AXLE	
F		STEER AXLE	
R		TRAILER	
R		<b>WABASH NATIONAL</b> VARIOUS	
R		<b>WATSON &amp; CHALIN MFG. INC.</b> LW5L-1100-SR SELF STEER AXLE SUSPENSION	
R		TRAILER AIR SUSPENSION	
R		WCTA SERIES DUMP TRAILER AIR SUSPENSION	
R		WCTA SERIES TRAILER AIR SUSPENSION	
R	89-21	WCTL-2200 SERIES TRAILER AIR LIFT	
R		WCWB SERIES TRAILER AIR SUSPENSION	
R	12-22	<b>WESTERN STAR</b> 4700SB All Models with Reycy 102 or 79KB Suspension (Drive Axle)	



# Numerical listing

Shock	POP	Alternative No.	MTG Acc. Supplied
Pos.	Year	Application	
<b>89430</b>	C (cont)		
R	12-22	4700SF	All Models with Reyco 102 or 79KB Suspension (Drive Axle)
<b>89431</b>	W		
F			<b>BLUE BIRD</b> ALL AMERICAN SERIES (FE & RE MODELS)
F			<b>FREIGHTLINER</b> MB CHASSIS MT55
F			VARIOUS
F	99-14	<b>INTERNATIONAL</b>	5600I All Models with 16,000 lb to 20,000 lb Front axle
F	00-12	5900I	All Models with 16,000 lb to 20,000 lb Front axle
F	18-23	HX520	All Models with 12,000 lb to 14,000 lb Parabolic Taperleaf Front Suspension
F		PAYSTAR	
F		SERIES 2000	- CONVENTIONAL TRUCK (SEVERE SERVICE)
F		SERIES 4000	- SHORT CONVENTIONAL MEDIUM TRK & TRAC
F		SERIES 8000	- CONVENTIONAL HEAVY DUTY TRACTOR
F		SERIES 9300, 9300I, 9400 & 9400I	LONG HOOD CONV.
F		SERIES 9600 & 9700	PREMIUM CABOVER TRACTOR
F		SERIES 9900, 9900I, 9900IX	LONG HOOD CONV. TRUCK
F		WORKSTAR	- 7000 SERIES
F		<b>OSHKOSH MOTOR TRUCK CO.</b>	VARIOUS
F		<b>PIERCE MFG. INC.</b>	VARIOUS
R	93-00	<b>SAFARI MOTOR COACH</b>	CLASS A MOTORHOMES
F		<b>THOMAS</b>	VARIOUS
<b>89432</b>	W		
F		<b>KENWORTH</b>	T660
F		W900, W900B, W900L, W900S	
<b>89434</b>	W		140149 (1)
R		<b>AUTOCAR LLC.</b>	ADDITIONAL APPLICATIONS
R	93-95	<b>VOLVO</b>	WCA & WIA SERIES
R	93-95	WG SERIES	
R	93-95	WH SERIES	
<b>89435</b>	W		140149 (1)
F	96-98	<b>FORD</b>	A9513 All Models with 12000 or 13200 lb Axle and 54" Multileaf Spring
F	97	A9522	All Models with 12000 or 13200 lb Axle and 54" Multileaf Spring
F	96-98	AT9513	All Models with 12000 or 13200 lb Axle and 54" Multileaf Spring
F	97-98	AT9522	All Models with 12000 or 13200 lb Axle and 54" Multileaf Spring
F		LOUISVILLE SERIES - CONVENTIONAL CAB	
F	99-10	<b>STERLING TRUCK</b>	A9500 All Models with 12000 or 13200 lb Axle and 54" Multileaf Spring
F	99-01	A9513	All Models with 12000 or 13200 lb Axle and 54" Multileaf Spring
F	99	A9522	All Models with 12000 or 13200 lb Axle and 54" Multileaf Spring
F	99-10	L8500	All Models with 12000 or 13200 lb Axle and 54" Multileaf Spring
F	99	L8501	All Models with 12000 or 13200 lb Axle and 54" Multileaf Spring
F	99-00	L8511	All Models with 12000 or 13200 lb Axle and 54" Multileaf Spring
F	99-01	L8513	All Models with 12000 or 13200 lb Axle and 54" Multileaf Spring
F	99-10	L9500	All Models with 12000 or 13200 lb Axle and 54" Multileaf Spring
F	99-00	L9501	All Models with 12000 or 13200 lb Axle and 54" Multileaf Spring
F	99-00	L9511	All Models with 12000 or 13200 lb Axle and 54" Multileaf Spring
F	99-00	L9513	All Models with 12000 or 13200 lb Axle and 54" Multileaf Spring

# 89000 Series

Shock	POP	Alternative No.	MTG Acc. Supplied
Pos.	Year	Application	
<b>89435</b>	W (cont)		140149 (1)
F	99-00	L9513	All Models with 12000 or 13200 lb Axle and 54" Multileaf Spring
F	99	L9522	All Models with 12000 or 13200 lb Axle and 54" Multileaf Spring
R		<b>VOLVO</b>	VN SERIES - 2200
R	96-98	WCA & WIA SERIES	
R	96-97	WH SERIES	
<b>89436</b>	B		
R		<b>BENSON TRUCK BODIES INC.</b>	VARIOUS
F		<b>CHANGE COACH</b>	TRANSIT BUS
R		<b>CUSH CORPORATION</b>	TRAILER SUSPENSIONS - LOW MOUNT TRAILER SUSPENSIONS - TOP MOUNT
R		<b>DURA SUSPENSION</b>	VARIOUS
R		<b>EAST MANUFACTURING CORP.</b>	VARIOUS
R	89-99	<b>FREIGHTLINER</b>	FLA086 All Models with Neway Tag Axle Air Suspension
R	02	FLB	All Models with Neway Tag Axle Air Suspension
R	94-99	FLB	All Models with Neway Tag Axle Air Suspension
R		<b>FRUEHAUF</b>	VARIOUS
R		<b>GREAT DANE TRAILER</b>	VARIOUS
R		<b>HENDRICKSON TRAILER</b>	SUSPENSION SYSTEMS
R			ADDITIONAL APPLICATIONS
R		INTRAA	
R		TOP MOUNT STYLE	
R		UNDERSLUNG STYLE	
R		VANTRAA	
F		<b>HIGHWAY PRODUCT</b>	VARIOUS
R		<b>HUTCHENS SUSPENSION</b>	VARIOUS
R		<b>INGERSOLL AXLES</b>	VARIOUS
R		<b>MC NEILS TRUCK &amp; MAN.</b>	VARIOUS
F		<b>ORION BUS</b>	VARIOUS
R		<b>PAGE SUSPENSION</b>	VARIOUS
R		<b>REYCO SUSPENSION</b>	TRAILER
R		<b>RIDEWELL CORP.</b>	BUS AND R.V. AIR-RIDES
R		TRAILER AIR-RIDES	
R		TRUCK AIR-RIDES	
R		<b>SAF HOLLAND</b>	TRAILER AIR SUSPENSION
R		TRUCK, BUS & MOTORHOME AIR SUSPENSIONS	
R		TRUCK & TRACTOR AIR SUSPENSION (TAG AXLE)	
R		<b>STOUGHTON TRAILERS INC.</b>	VARIOUS
R		<b>THOMAS</b>	VARIOUS
R		<b>TRAILMOBILE CANADA CORP.</b>	VARIOUS
R		<b>TUTHILL TECHNOLOGIIES</b>	TRAILER
R		<b>TWIN COACH</b>	VARIOUS
R		<b>UTILITY TRAILER</b>	MANUFACTURING COMPANY
R		FLATBEDS	
R		REEFFERS & DRY VANS	
R		<b>WABASH NATIONAL</b>	VARIOUS
R		<b>WATSON &amp; CHALIN MFG. INC.</b>	LWSL-1100-SR SELF STEER AXLE SUSPENSION
R		TRAILER AIR SUSPENSION	
R		VARIOUS	
R		WCTA-1200 SERIES TRAILER AIR SUSPENSION	
R		WCTA SERIES DUMP TRAILER AIR SUSPENSION	
R		WCTA SERIES TRAILER AIR SUSPENSION	
R		WCWB SERIES TRAILER AIR SUSPENSION	
<b>89437</b>	W		
R		<b>EAST MANUFACTURING CORP.</b>	VARIOUS
<b>89439</b>	W		145080 (2)
F	96-98	<b>FORD</b>	A9513 All All with 12000 lb, 13000 lb or 14600 lb Axle and 60" Taperleaf Spring

# Numerical listing

Shock	POP	Alternative No.	MTG Acc. Supplied
Pos.	Year	Application	
<b>89439</b>	W (cont)		145080 (2)
F	97	A9522	All All with 12000 lb, 13000 lb or 14600 lb Axle and 60" Taperleaf Spring
F	96-98	AT9513	All All with 12000 lb, 13000 lb or 14600 lb Axle and 60" Taperleaf Spring
F	97-98	AT9522	All All with 12000 lb, 13000 lb or 14600 lb Axle and 60" Taperleaf Spring
F	96-98	LOUISVILLE SERIES - CONVENTIONAL CAB	
F	99-10	<b>STERLING TRUCK</b>	A9500 All All Models with 12000 lb, 13200 lb or 14600 lb Axle and 60" Taperleaf Spring
F	99-10	A9500	All Models with 14600 lb or 16000 lb Axle and 54" Multi-leaf Spring
F	99-01	A9513	All All Models with 12000 lb, 13200 lb or 14600 lb Axle and 60" Taperleaf Spring
F	99-01	A9513	All Models with 14600 lb or 16000 lb Axle and 54" Multi-leaf Spring
F	99	A9522	All All Models with 12000 lb, 13200 lb or 14600 lb Axle and 60" Taperleaf Spring
F	99	A9522	All Models with 14600 lb or 16000 lb Axle and 54" Multi-leaf Spring
F	99-10	L8500	All Models with 12000 lb, 13200 lb or 14600 lb Axle and 60" Taperleaf Spring
F	99-10	L8500	All Models with 14600 lb or 16000 lb Axle and 54" Multi-leaf Spring
F	99	L8501	All Models with 12000 lb, 13200 lb or 14600 lb Axle and 60" Taperleaf Spring
F	99	L8501	All Models with 14600 lb or 16000 lb Axle and 54" Multi-leaf Spring
F	99-00	L8511	All Models with 12000 lb, 13200 lb or 14600 lb Axle and 60" Taperleaf Spring
F	99-00	L8511	All Models with 14600 lb or 16000 lb Axle and 54" Multi-leaf Spring
F	99-01	L8513	All Models with 12000 lb, 13200 lb or 14600 lb Axle and 60" Taperleaf Spring
F	99-01	L8513	All Models with 14600 lb or 16000 lb Axle and 54" Multi-leaf Spring
F	99-10	L9500	All Models with 12000 lb, 13200 lb or 14600 lb Axle and 60" Taperleaf Spring
F	99-10	L9500	All Models with 14600 lb or 16000 lb Axle and 54" Multi-leaf Spring
F	99-00	L9501	All Models with 12000 lb, 13200 lb or 14600 lb Axle and 60" Taperleaf Spring
F	99-00	L9501	All Models with 14600 lb or 16000 lb Axle and 54" Multi-leaf Spring
F	99-00	L9511	All Models with 12000 lb, 13200 lb or 14600 lb Axle and 60" Taperleaf Spring
F	99-00	L9511	All Models with 14600 lb or 16000 lb Axle and 54" Multi-leaf Spring
F	99-00	L9513	All Models with 12000 lb, 13200 lb or 14600 lb Axle and 60" Taperleaf Spring
F	99	L9522	All Models with 12000 lb, 13200 lb or 14600 lb Axle and 60" Taperleaf Spring
F	99	L9522	All Models with 14600 lb or 16000 lb Axle and 54" Multi-leaf Spring
<b>89440</b>	W		
F		<b>BLUE BIRD</b>	ADDITIONAL APPLICATIONS
R		WANDERLODGE	
R		<b>EAST MANUFACTURING CORP.</b>	VARIOUS
F	96-98	<b>FORD</b>	A9513 All All with 13200 lb or 14600 lb Axle and 54" Taperleaf Spring

Numerical listing

Shock	POP	Alternative No.	MTG Acc. Supplied
Pos.	Year	Application	
<b>89440</b>	W	(cont)	
F	97	A9522 All All with 13200 lb or 14600 lb Axle and 54" Taperleaf Spring	
F	96-98	AT9513 All All with 13200 lb or 14600 lb Axle and 54" Taperleaf Spring	
F	97-98	AT9522 All All with 13200 lb or 14600 lb Axle and 54" Taperleaf Spring	
F	96-98	LOUISVILLE SERIES - CONVENTIONAL CAB	
R		<b>HENDRICKSON TRAILER SUSPENSION SYSTEMS</b>	
R		ADDITIONAL APPLICATIONS	
R		TOP MOUNT STYLE	
R		UNDERSLUNG STYLE	
R		<b>HENDRICKSON TRUCK SUSPENSION SYSTEMS HN - SERIES</b>	
F		<b>INTERNATIONAL SERIES 3000 - SCHOOL BUS CHASSIS</b>	
R		SERIES 5000, 5000I - SEVERE SERVICE CONV TRK & TRAC	
R		SERIES 8000 - CONVENTIONAL HEAVY DUTY TRACTOR	
R		SERIES 9100, 9100I - TRACTOR & STRAIGHT TRUCK	
R		SERIES 9200, 9200I - TRACTOR & STRAIGHT TRUCK	
F		SERIES 9300, 9300I, 9400 & 9400I LONG HOOD CONV.	
R		SERIES 9300, 9300I, 9400 & 9400I LONG HOOD CONV.	
F		SERIES 9600 & 9700 PREMIUM CABOVER TRACTOR	
R		SERIES 9800 - PREMIUM CABOVER TRACTOR	
F		SERIES 9900, 9900I, 9900IX LONG HOOD CONV. TRUCK	
R		SERIES 9900, 9900I, 9900IX LONG HOOD CONV. TRUCK	
F		<b>PACIFIC TRUCK &amp; TRAILER</b>	
R		VARIOUS	
R		<b>PIERCE MFG. INC. VARIOUS REYCO SUSPENSION DRIVE AXLE</b>	
R		<b>SAF HOLLAND TRUCK, BUS &amp; MOTORHOME AIR SUSPENSIONS</b>	
R	00-21	TRUCK, BUS & MOTORHOME AIR SUSPENSIONS	
R	97-00	<b>SPARTAN MOTORS HIGHLANDER</b> All With I Beam Front Suspension	
R	91-96	K2	
R	97-00	K2 All With I Beam Front Suspension	
R	97-00	K2 All With Independent Front Granning Suspension	
R	97-00	MOUNTAIN MASTER All With Independent Front Granning Suspension	
R	95-00	MOUNTAIN MASTER All With I Beam Front Suspension	
F	99-10	<b>STERLING TRUCK A9500</b> All All with 13200 lb or 14600 lb Axle and 54" Taperleaf Spring	
F	99-01	A9513 All All with 13200 lb or 14600 lb Axle and 54" Taperleaf Spring	
F	99	A9522 All All with 13200 lb or 14600 lb Axle and 54" Taperleaf Spring	
F	99-10	L8500 All All with 13200 lb or 14600 lb Axle and 54" Taperleaf Spring	
F	99	L8501 All All with 13200 lb or 14600 lb Axle and 54" Taperleaf Spring	
F	99-01	L8513 All All with 13200 lb or 14600 lb Axle and 54" Taperleaf Spring	
F	99-10	L9500 All All with 13200 lb or 14600 lb Axle and 54" Taperleaf Spring	
F	99-00	L9501 All All with 13200 lb or 14600 lb Axle and 54" Taperleaf Spring	
F	99-01	L9511 All All with 13200 lb or 14600 lb Axle and 54" Taperleaf Spring	
F	99-00	L9513 All All with 13200 lb or 14600 lb Axle and 54" Taperleaf Spring	
F	99	L9522 All All with 13200 lb or 14600 lb Axle and 54" Taperleaf Spring	
R		<b>TUTHILL TECHNOLOGIIES DRIVE AXLE</b>	
R		<b>WABASH NATIONAL VARIOUS</b>	
<b>89442</b>	W		145126 (2)
F	98	<b>WESTERN STAR 3800</b>	
F	99-01	3800 All Models with Multi-Leaf Front Springs	
F	89-97	3800 All Models with Multi-Leaf Front Springs	

89000 Series

Shock	POP	Alternative No.	MTG Acc. Supplied
Pos.	Year	Application	
<b>89442</b>	W	(cont)	145126 (2)
F	89-02	4800 All Models with Multi-Leaf Front Springs	
F	89-02	4900 All Models with Multi-Leaf Front Springs	
F	97-02	5800 All Models with Multi-Leaf Front Springs	
F	89-01	5900 All Models with Multi-Leaf Front Springs	
F	89-01	6900 All Models with Multi-Leaf Front Springs	
<b>89443</b>	C		
R	13-24	<b>DYNAMAX CORP DX3</b> All Models with Airliner 21,000 lb Rear Air Suspension	
R	05-07	<b>DYNAQUEST</b> All Models with Airliner 18,000 lb Rear Air Suspension	
R	09-14	<b>DYNAQUEST ST</b> All Models with Airliner 18,000 lb Rear Air Suspension	
R	09-24	<b>DYNAQUEST XL</b> All Models with FAS II (40,000 lb) Rear Air Suspension	
R	21-24	<b>EUROPA</b> All Models with Airliner 21,000 lb Rear Air Suspension	
R	22	<b>FORCE HD</b> All Models with Airliner 21,000 lb Rear Air Suspension	
R	15-18	<b>FORCE HD</b> All Models with Airliner 21,000 lb Rear Air Suspension	
R	02-04	<b>GRAND SPORT</b> All Models 23,000 lb Airliner Rear Air Suspension	
R	09-14	<b>GRAND SPORT GT</b> All Models with Freightliner Airliner Rear Air Suspension	
R	07-13	<b>GRAND SPORT GT TOY HAULER</b> All Models 21K or 23K Airliner Rear Air Suspension	
R	03-07	<b>GRAND SPORT M2</b> All Models with Airliner 21,000 lb Rear Air Suspension	
R	07-14	<b>GRAND SPORT ULTRA</b> All Models 23,000 lb Airliner Rear Air Suspension	
R	20-24	<b>INTEGRA COACH ACCOLADE</b> All Models with Freightliner S2RV chassis	
R	21-24	<b>ACCOLADE XL</b> All Models with Freightliner S2RV chassis	
R	02-19	<b>FEDERAL COACH VARIOUS</b>	
R	12-24	<b>FREIGHTLINER 108SD</b> All Models with FAS II (40,000 lb) Rear Air Suspension	
R	12-24	114SD All Models with FAS II (40,000 lb) Rear Air Suspension	
R	13-23	122SD All Models with FAS II (40,000 lb) Rear Air Suspension	
R	99-15	<b>ARGOSY</b> All Models with FAS II (40,000 lb) Rear Air Suspension	
R	05-23	<b>B2</b> All Models with FAS II (40,000 lb) Rear Air Suspension	
R	08-24	<b>CASCADIA</b> All Models with FAS II (40,000 lb) Rear Air Suspension	
R	96-11	<b>CENTURY CLASS</b> All Models with FAS II (40,000 lb) Rear Air Suspension	
R	01-11	<b>CLASSIC</b> All Models with FAS II (40,000 lb) Rear Air Suspension	
R	01-09	<b>CLASSIC XL</b> All Models with FAS II (40,000 lb) Rear Air Suspension	
R	00-20	<b>COLUMBIA</b> All Models with FAS II (40,000 lb) Rear Air Suspension	
R	01-07	<b>CONDOR</b> All Models with FAS II (40,000 lb) Rear Air Suspension	
R	01-20	<b>CORONADO</b> All Models with FAS II (40,000 lb) Rear Air Suspension	
R	05-07	FC70	
R	99-04	FC70 All Models with FAS II (40,000 lb) Rear Air Suspension	
R	99-07	FC80 All Models with FAS II (40,000 lb) Rear Air Suspension	
R	91-06	FL70 All Models with FAS II (40,000 lb) Rear Air Suspension	
R	91-06	FL80 All Models with FAS II (40,000 lb) Rear Air Suspension	
R	89-99	FLA086 All Models with FAS II (40,000 lb) Rear Air Suspension	
R	02	FLB All Models with FAS II (40,000 lb) Rear Air Suspension	
R	94-99	FLB All Models with FAS II (40,000 lb) Rear Air Suspension	
R	95-01	FLC112 All Models with FAS II (40,000 lb) Rear Air Suspension	

Numerical listing

Shock	POP	Alternative No.	MTG Acc. Supplied
Pos.	Year	Application	
<b>89443</b>	C	(cont)	
R	95-08	FLD112 All Models with FAS II (40,000 lb) Rear Air Suspension	
R	95-11	FLD120 All Models with FAS II (40,000 lb) Rear Air Suspension	
R	05-12	FLD120SD All Models with FAS II (40,000 lb) Rear Air Suspension	
R	03	FLD120SD All Models with FAS II (40,000 lb) Rear Air Suspension	
R	03-11	FLD132 All Models with FAS II (40,000 lb) Rear Air Suspension	
R	01	FLD132 All Models with FAS II (40,000 lb) Rear Air Suspension	
R	05-21	M2 All Models with FAS II (40,000 lb) Rear Air Suspension	
R	02-10	M2 100 All Models with FAS II (40,000 lb) Rear Air Suspension	
R	05-06	M2 106 All Models with FAS II (40,000 lb) Rear Air Suspension	
R	02-03	M2 106 All Models with FAS II (40,000 lb) Rear Air Suspension	
R	03-24	M2 112 All Models with FAS II (40,000 lb) Rear Air Suspension	
R	18-24	<b>VARIOUS</b>	
R		<b>RENEGADE VARIOUS</b>	
R	99-10	<b>STERLING TRUCK A9500</b> All Models with FAS II (40,000 lb) Rear Air Suspension	
R	99-01	A9513 All Models with FAS II (40,000 lb) Rear Air Suspension	
R	99	A9522 All Models with FAS II (40,000 lb) Rear Air Suspension	
R	10	<b>ACTERRA</b> All Models with FAS II (40,000 lb) Rear Air Suspension	
R	08	<b>ACTERRA</b> All Models with FAS II (40,000 lb) Rear Air Suspension	
R	03-06	<b>ACTERRA</b> All Models with FAS II (40,000 lb) Rear Air Suspension	
R	01-07	<b>ACTERRA 5500</b> All Models with FAS II (40,000 lb) Rear Air Suspension	
R	02-07	<b>ACTERRA 6500</b> All Models with FAS II (40,000 lb) Rear Air Suspension	
R	01-07	<b>ACTERRA 7500</b> All Models with FAS II (40,000 lb) Rear Air Suspension	
R	01-03	<b>ACTERRA 8500</b> All Models with FAS II (40,000 lb) Rear Air Suspension	
R	99-10	L8500 All Models with FAS II (40,000 lb) Rear Air Suspension	
R	99	L8501 All Models with FAS II (40,000 lb) Rear Air Suspension	
R	99-00	L8511 All Models with FAS II (40,000 lb) Rear Air Suspension	
R	99-01	L8513 All Models with FAS II (40,000 lb) Rear Air Suspension	
R	99-10	L9500 All Models with FAS II (40,000 lb) Rear Air Suspension	
R	99-00	L9501 All Models with FAS II (40,000 lb) Rear Air Suspension	
R	99-01	L9511 All Models with FAS II (40,000 lb) Rear Air Suspension	
R	99-00	L9513 All Models with FAS II (40,000 lb) Rear Air Suspension	
R	99	L9522 All Models with FAS II (40,000 lb) Rear Air Suspension	
R	91-24	<b>THOMAS SAF-T-LINER</b> All Models 21K or 23K Airliner Rear Air Suspension	
R		<b>VARIOUS</b>	
R	19-24	<b>TIFFIN ALLEGRO BAY</b> All Models with Freightliner S2RV chassis	
R	22-24	<b>WESTERN STAR 47X</b> All Models with FAS II (40,000 lb) Rear Air Suspension	
R	21-24	49X All Models with FAS II (40,000 lb) Rear Air Suspension	
R	23-24	57X All Models with FAS II (40,000 lb) Rear Air Suspension	
R	12-22	4700SB All Models with FAS II (40,000 lb) Rear Air Suspension	
R	12-22	4700SF All Models with FAS II (40,000 lb) Rear Air Suspension	
R	16-22	5700XE All Models with Airliner Rear Air Suspension	
<b>89447</b>	W		141108 (1)
R		<b>BLUE BIRD ADDITIONAL APPLICATIONS</b>	
F	03-18	<b>IC CORPORATION RE SCHOOL BUS</b> All RE Model School Buses with O.E.M. Number	
F		<b>INTERNATIONAL F &amp; S SERIES</b>	

## Numerical listing

Shock	POP	Alternative No.	MTG Acc. Supplied
Pos.	Year	Application	
<b>89447</b>	W	(cont)	141108 (1)
F		METRO & MULTI-SHOP SERIES	
F		SERIES 1000 FORWARD CONTROL CHASSIS	
F		SERIES 2000 - CONVENTIONAL TRUCK (SEVERE SERVICE)	
F		SERIES 3000 - SCHOOL BUS CHASSIS	
F		SERIES 7000 - SHORT CONV. MEDIUM TRUCK & TRACTOR	
F		SERIES 8000 - CONVENTIONAL HEAVY DUTY TRACTOR S SERIES SCHOOL BUS	
F	86-88	<b>mitsubishi fuso</b> FM All Model with O.E.M. Number	
F		<b>NEOPLAN</b> VARIOUS	
<b>89448</b>	D		
R	04-07	<b>MACK</b> CHN All CHN-613 Models w/ MACK Air Suspension	
R	98-05	CX All CX Vision Models w/ MACK Air Suspension	
R	05-07	CXN All CXN-613 Models w/ MACK Air Suspension	
R	06-11	<b>POWERHOUSE COACH INC.</b> VARIOUS	
R	06-11	<b>RENEGADE</b> VARIOUS	
R	04	<b>VOLVO</b> VN All Models with O.E.M. Number	
R	99	VN All Models with O.E.M. Number	
R	00-11	VNL All Models with 38,000 lb Rear Air Suspension	
R	06-11	VNL 300	
R	05-11	VNL 430	
R	06-11	VNL 630	
R	06-11	VNL 670	
R	06-11	VNL SERIES	
R		VN SERIES - 2200	
R	00	VN SERIES - 2200	
R	06-10	VT All 64T-830 Models with 40,000 lb Rear Air Suspension	
<b>89449</b>	D		
F	02-04	<b>DYNAMAX CORP</b> GRAND SPORT All Models with 12000 lb Taperleaf Front Suspension	
F	07-08	GRAND SPORT GT TOY HAULER All 410TH & 450TH Models with 12000 lb Taperleaf Front Suspension	
F	07-08	GRAND SPORT ULTRA All Models with 14,000 lb Taperleaf Front Suspension	
F	20-24	<b>ENTEGR</b> A COACH ACCOLADE All Models with Freightliner S2RV chassis	
F	21-24	ACCOLADE XL All Models with Freightliner S2RV chassis	
F	12-23	<b>FREIGHTLINER</b> 114SD All All Models with 18,000 lb Flat Leaf Spring	
F	99-15	ARGOSY All Models with 12000 lb Taperleaf Front Suspension	
F	05-23	B2 All Models with 12000 lb Taperleaf Front Suspension	
F	08	CASCADIA All 125 Models with 12000 to 13300 lb Taperleaf Front Suspension	
F		CENTURY CLASS	
F	00-11	CENTURY CLASS All Models with 12000 lb Taperleaf Front Suspension	
F	01-11	CLASSIC All Models with 12000 lb Taperleaf Front Suspension	
F	01-09	CLASSIC XL All Models with 12000 lb Taperleaf Front Suspension	
F	00-08	COLUMBIA All Models with 12000 lb Taperleaf Front Suspension	
F	01-07	CONDOR All Models with 14,600 to 20,000 lb Front Suspension	
F	01-09	CORONADO All Models with 12000 lb Taperleaf Front Suspension	
F	95-01	FLC112 All Models with 12000 lb Taperleaf Front Suspension	
F	95-08	FLD112 All Models with 12000 lb Taperleaf Front Suspension	
F	95-08	FLD120 All Models with 12000 lb Taperleaf Front Suspension	
F	05-08	FLD120SD All Models with 12000 lb Taperleaf Front Suspension	
F	03	FLD120SD All Models with 12000 lb Taperleaf Front Suspension	
F	05-08	FLD132 All Models with 12000 lb Taperleaf Front Suspension	
F	06-08	FRED CHASSIS	
F	03-08	M2 112 All Models with 12000 lb to 20000 Front Axle	

## 89000 Series

Shock	POP	Alternative No.	MTG Acc. Supplied
Pos.	Year	Application	
<b>89449</b>	D	(cont)	
F		MC CHASSIS	
F	18-24	VARIOUS	
F	99-03	<b>STERLING TRUCK</b> A9500 All Models with 12000 lb Taperleaf Front Suspension	
F	99-01	A9513 All Models with 12000 lb Taperleaf Front Suspension	
F	99	A9522 All Models with 12000 lb Taperleaf Front Suspension	
F	95-23	<b>THOMAS</b> SAF-T-LINER All Models with 12000 lb Taperleaf Front Suspension	
F	95-23	SAF-T-LINER All Models with Freightliner CC B2 Bus Chassis	
F	19-24	<b>TIFFIN</b> ALLEGRO BAY All Models with Freightliner S2RV chassis	
F	12-20	<b>WESTERN STAR</b> 4700SF All Models with 18,000 lb - 20,000 lb Flat Leaf Spring	
<b>89450</b>	W		
F	21-24	<b>MACK</b> ANTHEM All Anthem 64T Models with 12,000 to 12,500 lb Front Axles	
F	18-24	ANTHEM All Models with 13,200 to 14,600 lb Front Axles	
F	04-07	CHN All CHN-613 Models with 12,000 lb Front Axle	
R	07	CHU	
R	98-05	CX All CX Vision Models w/ Hendrickson Air Suspension	
R	98-05	CX All CX Vision Models w/ Parabolic Spring	
F	98-05	CX All Models with O.E.M. Number	
F	05-08	CXN All CXN-613 Models with 12,000 lb Front Axles	
R	08	CXN All CXN-613 Models with 40,000 lb Rear Air Suspensions	
F	06-07	CXP All CXP-613 Models with 12,000 lb Front Axles	
R	06-07	CXP All CXP-613 Models with 40,000 lb Rear Air Suspensions	
F	08-19	CXU All Models with 12,000 - 14,600 lb Front Axles	
F	06-10	<b>POWERHOUSE COACH INC.</b> VARIOUS	
F	06-10	<b>RENEGADE</b> VARIOUS	
F	14	<b>VOLVO</b> VAH SERIES	
F	00-24	VNL All Models with 12,000 - 13,200 lb Front Axles	
F	06-24	VNL 300	
F	16-20	VNL 300 All Models with 12,000 - 13,200 lb Front Axles	
F	06-10	VNL 430	
F	15-16	VNL 430 All Models with 12,500 - 14,600 lb Front Axle	
F	06-10	VNL 630	
F	15-16	VNL 630 All Models with 12,500 - 14,600 lb Front Axle	
F	06-10	VNL 670	
F	15-16	VNL 670 All Models with 12,500 - 14,600 lb Front Axle	
F	17-24	VNL 740	
F	17-20	VNL 740 All Models with 12,500 - 14,600 lb Front Axle	
F	21-24	VNL 760	
F	17-20	VNL 760 All Models with 12,500 - 14,600 lb Front Axle	
F	20	VNL 760 All Models with 13,200 lb to 14,600 lb Front Axle	
F	21-24	VNL 860	
F	17-20	VNL 860 All Models with 12,500 - 14,600 lb Front Axle	
F	06-24	VNL SERIES	
F	11-18	VNM All Models with 12,000 - 14,600 lb Front Axle	
F	21-24	VNR All Models with 12,000 lb to 12,500 lb Front Axle	
F	21-24	VNR All Models with 13,200 lb to 14,600 lb Front Axle	
F	18-19	VNR All Models with 12,500 lb Front Axle	
F	17-24	VNR 300	
F	17-24	VNR 400	
F	17-24	VNR 640	
F		VN SERIES - 2200	
F	19-20	VNX All Models with 12,500 - 14,600 lb Front Axle	
F	14-17	VNX All Models with 12,500 - 14,600 lb Front Axle	
F	06-10	VT All All Models with 12,000 - 13,200 lb Front Axles	

## Numerical listing

Shock	POP	Alternative No.	MTG Acc. Supplied
Pos.	Year	Application	
<b>89451</b>	C		
R	01-16	<b>KENWORTH</b> C500 All Models with Air Glide 380 (AG380) Rear Air Suspension	
R	16-17	ICON 900	
R	12-21	T440	
R	10-19	T470	
R	01-07	T600, T600B, T602	
R	01-08	T600A All Models with Air Glide 380 (AG380) Rear Air Suspension	
R	07-20	T660 All Models with Air Glide 380 (AG380) Rear Air Suspension	
R	11-24	T680 All Models with Air Glide 380 (AG380) Rear Air Suspension	
R	11-16	T700 All Models with Air Glide 380 (AG380) Rear Air Suspension	
R	01-23	T800 All Models with Air Glide 380 (AG380) Rear Air Suspension	
R	01-09	T800B, T800B(8X4), T800SH, T800H, T800W	
R	11-24	T880 All Models with Air Glide 380 (AG380) Rear Air Suspension	
R	01-11	T2000 All Models with Air Glide 380 (AG380) Rear Air Suspension	
R	01-21	W900 All Models with Air Glide 380 (AG380) Rear Air Suspension	
R	01-21	W900B, W900L, W900S	
R	19-24	W990 All Models with Air Glide 380 (AG380) Rear Air Suspension	
R	08-20	<b>PETERBILT</b> 365 All Models with FlexAir Suspension (38000 lb)	
R	08-20	367 All Models with FlexAir Suspension (38000 lb)	
R	99-07	378 All Models with FlexAir Suspension (38000 lb)	
R	99-07	379 All Models with FlexAir Suspension (38000 lb)	
R	11-17	382 All Models with FlexAir Suspension (38000 lb)	
R	08-16	384 All Models with FlexAir Suspension (38000 lb)	
R	95-07	385 All Models with FlexAir Suspension (38000 lb)	
R	06-16	386 All Models with FlexAir Suspension (38000 lb)	
R	00-11	387 All Models with FlexAir Suspension (38000 lb)	
R	08-15	388 All Models with FlexAir Suspension (38000 lb)	
R	08-24	389 All Models with FlexAir Suspension (38000 lb)	
R	14-24	567 All Models with FlexAir Suspension (38000 lb)	
R	13-24	579 All Models with FlexAir Suspension (38000 lb)	
R	11-18	587 All Models with FlexAir Suspension (38000 lb)	
<b>89453</b>	W		
F	09-22	<b>FREIGHTLINER</b> CASCADIA All Models with Hendrickson Front Airtek	
F	00-11	CENTURY CLASS All Models with Hendrickson Front Airtek	
F	01-11	CLASSIC All Models with Hendrickson Front Airtek	
F	01-09	CLASSIC XL All Models with Hendrickson Front Airtek	
F	00-20	COLUMBIA All Models with Hendrickson Front Airtek	
F	01-20	CORONADO All Models with Hendrickson Front Airtek	
F	02-08	FLD112 All Models with Hendrickson Front Airtek	
F	02-11	FLD120 All Models with Hendrickson Front Airtek	
F	05-12	FLD120SD All Models with Hendrickson Front Airtek	
F	03	FLD120SD All Models with Hendrickson Front Airtek	
F	03-11	FLD132 All Models with Hendrickson Front Airtek	
F		<b>HENDRICKSON TRUCK SUSPENSION SYSTEMS</b> AIRTEK - SERIES	
F		<b>MC NEILLUS TRUCK &amp; MAN.</b> VARIOUS	
F	10	<b>STERLING TRUCK</b> ACTERRA All Models with Hendrickson Front Airtek	
F	08	ACTERRA All Models with Hendrickson Front Airtek	
F	03-06	ACTERRA All Models with Hendrickson Front Airtek	



Numerical listing

Shock	POP	Alternative No.	MTG Acc. Supplied
Pos.	Year	Application	
<b>89453</b> W (cont)			
F	01-07	ACTERRA 5500	All Models with Hendrickson Front Airtek
F	02-07	ACTERRA 6500	All Models with Hendrickson Front Airtek
F	01-07	ACTERRA 7500	All Models with Hendrickson Front Airtek
F	01-03	ACTERRA 8500	All Models with Hendrickson Front Airtek
F	00-02	<b>WESTERN STAR</b> 4800	All Models with Hendrickson Front Airtek
F	12-22	4800SB	All Models with Hendrickson Front Airtek
F	13-22	4800SF	All Models with Hendrickson Front Airtek
F	00-02	4900E	All Models with Hendrickson Front Airtek
F	02-22	4900EX	All Models with Hendrickson Front Airtek
F	02-22	4900FA	All Models with Hendrickson Front Airtek
F	02-22	4900SA	All Models with Hendrickson Front Airtek
F	16-22	5700XE	All Models with Hendrickson Front Airtek
F	00-01	5900	All Models with Hendrickson Front Airtek
F	00-01	6900	All Models with Hendrickson Front Airtek
F	22	6900XD	All Models with Hendrickson Front Airtek
F	18-19	6900XD	All Models with Hendrickson Front Airtek
F	02-16	6900XD	All Models with Hendrickson Front Airtek
<b>89454</b> W			
F		<b>HENDRICKSON TRUCK SUSPENSION SYSTEMS AIRTEK - SERIES</b>	
F		<b>MACK ADDITIONAL APPLICATIONS</b>	
F	04-08	CXN	All CXN-613 Models with Hendrickson AirTek Front Air Suspension
F		<b>MC NEILUS TRUCK &amp; MAN. VARIOUS</b>	
F	06-19	<b>POWERHOUSE COACH INC. VARIOUS</b>	
F		<b>VOLVO ADDITIONAL APPLICATIONS</b>	
F	05-19	VNL	All Models with Hendrickson Airtek
F	06-14	VNL 300	
F	16-19	VNL 300	All Models with Hendrickson Airtek
F	05-14	VNL 430	
F	17-18	VNL 630	
F	06-14	VNL 630	
F	15-16	VNL 630	All Models with Hendrickson Airtek
F	17-18	VNL 670	
F	06-14	VNL 670	
F	15-16	VNL 670	All Models with Hendrickson Airtek
F	17-19	VNL 740	All Models with Hendrickson Airtek
F	17-19	VNL 760	All Models with Hendrickson Airtek
F	06-16	VNL SERIES	
F	18-19	VNL	All Models with Hendrickson Airtek
<b>89455</b> C <b>141108 (1)</b>			
R	08-23	<b>KENWORTH</b> T370	All Models with AG210L Rear Air Suspension
R	11-21	T440	
R	10-21	T470	
R	07-20	T660	All Models with Air Glide 400L (AG400L) Rear Air Suspension
R	13-24	T680	All Models with Air Glide 400L (AG400L) Rear Air Suspension
R	11-16	T700	All Models with Air Glide 400L (AG400L) Rear Air Suspension
R	08-23	T800	All Models with Air Glide 400L (AG400L) Rear Air Suspension
R	11-24	T880	All Models with Air Glide 400L (AG400L) Rear Air Suspension
R	08-24	W900	All Models with Air Glide 400L (AG400L) Rear Air Suspension
R	19-24	W990	All Models with Air Glide 400L (AG400L) Rear Air Suspension
R	02-18	<b>PETERBILT</b> 320	All Models with Peterbilt Low Air Leaf Suspension

89000 Series

Shock	POP	Alternative No.	MTG Acc. Supplied
Pos.	Year	Application	
<b>89455</b> C (cont) <b>141108 (1)</b>			
R	07-22	330	All Models with Peterbilt Low Air Leaf Suspension
R	03-05	330	All Models with Peterbilt Low Air Leaf Suspension
R	05-10	335	All Models with Peterbilt Low Air Leaf Suspension
R	10-23	337	All Models with Peterbilt Low Air Leaf Suspension
R	02-08	357	All Models with Peterbilt Low Air Leaf Suspension
R	02-06	362	All Models with Peterbilt Low Air Leaf Suspension
R	08-23	365	All Models with Peterbilt Low Air Leaf Suspension
R	08-23	367	All Models with Peterbilt Low Air Leaf Suspension
R	03-07	378	All Models with Peterbilt Low Air Leaf Suspension
R	03-07	379	All Models with Peterbilt Low Air Leaf Suspension
R	11-17	382	All Models with Peterbilt Low Air Leaf Suspension
R	08-16	384	All Models with Peterbilt Low Air Leaf Suspension
R	04-07	385	All Models with Peterbilt Low Air Leaf Suspension
R	06-16	386	All Models with Peterbilt Low Air Leaf Suspension
R	03-11	387	All Models with Peterbilt Low Air Leaf Suspension
R	08-15	388	All Models with Peterbilt Low Air Leaf Suspension
R	08-24	389	All Models with Peterbilt Low Air Leaf Suspension
R	17-23	520	All Models with Peterbilt Low Air Leaf Suspension
R	22-24	537	All Models with Peterbilt Low Air Leaf Suspension
R	22-23	548	All Models with Peterbilt Low Air Leaf Suspension
R	14-24	567	All Models with Peterbilt Low Air Leaf Suspension
R	13-24	579	All Models with Peterbilt Low Air Leaf Suspension
R	11-18	587	All Models with Peterbilt Low Air Leaf Suspension
<b>89456</b> W <b>145089-200 (1)</b>			
R	16-17	<b>KENWORTH</b> ICON 900	
R	12-19	T440	
R	10-17	T470	
R	01-07	T600, T600B, T602	
R	01-08	T600A	All Models with Air Glide 400 (AG400) Rear Air Suspension
R	13-18	T660	All Models with Air Glide 400 (AG400) Rear Air Suspension
R	13-24	T680	All Models with Air Glide 400 (AG400) Rear Air Suspension
R	11-16	T700	All Models with Air Glide 400 (AG400) Rear Air Suspension
R	01-23	T800	All Models with Air Glide 400 (AG400) Rear Air Suspension
R	10-21	T800, T800B, T800B(8X4), T800SH, T800H, T800W	
R	07-09	T800B, T800B(8X4), T800SH, T800H, T800W	
R	11-24	T880	All Models with Air Glide 400 (AG400) Rear Air Suspension
R	05-11	T2000	All Models with Air Glide 400 (AG400) Rear Air Suspension
R	04-24	W900	All Models with Air Glide 400 (AG400) Rear Air Suspension
R	05-21	W900, W900B, W900L, W900S	
R	19-24	W990	All Models with Air Glide 400 (AG400) Rear Air Suspension
<b>89457</b> W			
F		<b>INTERNATIONAL</b> 9100I	
F		9200I	
F	00-09	9200I SBA	All Models with 12,000 lb Front Axle
F	00	9200 SBA	All Models with 12,000 lb Front Axle
F	00	9300	All Models with 12,000 lb Front Axle
F	00	9400	All Models with 12,000 lb Front Axle
F	00-09	9400I SBA	All Models with 12,000 lb Front Axle
F	04-09	9900I	All Models with 12,000 lb Front Axle
F	04-09	9900IX	All Models with 12,000 lb Front Axle

Numerical listing

Shock	POP	Alternative No.	MTG Acc. Supplied
Pos.	Year	Application	
<b>89457</b> W (cont)			
F		SERIES 9200, 9200I - TRACTOR & STRAIGHT TRUCK	
F		SERIES 9900, 9900I, 9900IX LONG HOOD CONV. TRUCK	
F	19-21	WORKSTAR - 7000 SERIES	
<b>89458</b> W			
R	08-09	<b>INTERNATIONAL</b> 4400	All Models with International 40,000 lb Rear Air Suspension
R	02-07	8500	All Models with International 40,000 lb Rear Air Suspension
R	08-09	8500 TRANSTAR	All Models with International 40,000 lb Rear Air Suspension
R	08-09	8600 TRANSTAR	All Models with International 40,000 lb Rear Air Suspension
R	04-09	9200I SBA	All All models with 40,000 lb Rear Air Suspension
R	04-09	9400I SBA	All All models with 40,000 lb Rear Air Suspension
R	04-09	9900I	All All models with 40,000 lb Rear Air Suspension
R	04-09	9900IX	All All models with 40,000 lb Rear Air Suspension
R	10-11	DURASTAR - 4300, 4400 SERIES	
R	12-16	LONESTAR	All Models with International 40,000 lb Rear Air Suspension (52" Spacing- Heavy Duty Rear)
R	09-15	LONESTAR	All All models with 40,000 lb Rear Air Suspension
R		LONESTAR - SERIES	
R		PAYSTAR - 5000 SERIES	
R		PROSTAR	
R	09-17	PROSTAR	All All models with 40,000 lb Rear Air Suspension
R		SERIES 9200, 9200I - TRACTOR & STRAIGHT TRUCK	
R		SERIES 9300, 9300I, 9400 & 9400I LONG HOOD CONV.	
R		SERIES 9900, 9900I, 9900IX LONG HOOD CONV. TRUCK	
R	10-11	SERIES 9900, 9900I, 9900IX LONG HOOD CONV. TRUCK	
R		TRANSTAR - 8500, 8600 SERIES	
R	10-18	TRANSTAR - 8500, 8600 SERIES	
R		WORKSTAR - 7000 SERIES	
<b>89459</b> W <b>401754 (2)</b>			
F	12-22	<b>KENWORTH</b> T440	
F	10-21	T470	
F	05-07	T600, T600B, T602	
F	05-08	T600A	All Models with 13,000 lb Front Axle
F	07-20	T660	All Models with 12,000 or 13,200 lb Front Axle
F	11-16	T700	All Models with 13,000 lb Front Axle
F	05-23	T800	All Models with 12,000 to 20,000 lb Front Axles
F	06-11	T2000	All Models with 13,000 lb Front Axle
F	05-22	W900	All Models with 12,000 or 13,200 lb Front Axle
<b>89460</b> W			
F	10-14	<b>KENWORTH</b> T370	All Models with 10,000 lb to 12,000 lb Front Axle
F	10-14	T370	All Models with 13,200 lb to 14,600 lb Front Axle
F	10-14	T370	All Models with 8,000 lb Front Axle
F	13-14	T680	All Models with 10,000 lb to 13,200 lb Front Axle
F	10-14	<b>PETERBILT</b> 337	All Models with 10,000 lb to 12,000 lb Front Axle
F	10-14	337	All Models with 13,200 lb to 14,600 lb Front Axle
F	12-13	348	All Models with 10,000 lb to 12,000 lb Front Axle
F	11-17	382	All Models with 10,000 lb to 12,000 lb Front Axle
F	13-16	579	All Day Cab Models with 10,000 lb to 12,000 lb Front Axle
<b>89503</b> W			
F	05-07	<b>DYNAMAX CORP</b> DYNAQUEST	All Models with 10000 to 12000 lb. Taper-leaf Spring Suspension
F	07-08	GRAND SPORT GT TOY HAULER	All 390TH Models with 12000 lb Taperleaf Front Suspension

## Numerical listing

Shock	POP	Alternative No.	MTG Acc. Supplied
Pos.	Year	Application	
<b>89503</b>		W (cont)	
F	03-07	GRAND SPORT M2 All Models with 10000 to 12000 lb. Taper-leaf Spring Suspension	
F	02-08	<b>FEDERAL COACH</b> VARIOUS	
F	05-06	<b>FREIGHTLINER</b> M2 106 All Models with 10000 to 12000 lb. Taper-leaf Spring Suspension	
F	05-06	M2 106 All Models with 6000 to 9000 lb Front axle	
F	02-03	M2 106 All Models with 10000 to 12000 lb. Taper-leaf Spring Suspension	
F	02-03	M2 106 All Models with 6000 to 9000 lb Front axle	
F	01-09	<b>STERLING TRUCK</b> ACTERRA	

### Specialty Shock

<b>619501</b>	W	98-22	<b>INTERNATIONAL</b> VARIOUS
---------------	---	-------	------------------------------

<b>632147</b>	W		<b>CHALLENGE COOK</b> CEMENT TRUCK <b>MC NEILUS TRUCK &amp; MAN.</b> VARIOUS <b>WATSON &amp; CHALIN MFG. INC.</b> VARIOUS
---------------	---	--	---

<b>646155</b>	A		<b>ADVANCE MIXER</b> VARIOUS <b>CHALLENGE COOK</b> CEMENT TRUCK <b>GRANNING SUSPENSION</b> MODEL L120 SELF STEER AXLE <b>HENDRICKSON TRAILER SUSPENSION SYSTEMS</b> HLP PARALIFT HLU PARALIFT ULTRA <b>HENDRICKSON TRUCK SUSPENSION SYSTEMS</b> TOUGH LIFT LK SERIES <b>KIMBLE MIXER CO.</b> REAR DISCHARGE MIXERS REAR DISCHARGE MIXERS <b>LONDON MIXER</b> VARIOUS <b>MC NEILUS TRUCK &amp; MAN.</b> VARIOUS <b>REX MIXER</b> VARIOUS <b>RIDEWELL CORP.</b> VARIOUS <b>SAF HOLLAND</b> VARIOUS <b>SUSPENSIONS INC.</b> VARIOUS <b>TEREX CORP.</b> VARIOUS <b>TUTHILL TECHNOLOGIES</b> VARIOUS <b>WATSON &amp; CHALIN MFG. INC.</b> LW5L-1100 SR SL-2089 STEERABLE LIFT AXLE SUSPENSION WCAL-1000 SST WCAL-1100 LR WCAL-1100 SR WCAL-1100 SRLP WCAL-1100 SSR WCHL-1100 FL WCHL-1100 HI-LIFT
---------------	---	--	--

<b>646177</b>	A		<b>CHALLENGE COOK</b> CEMENT TRUCK
R	11-23	<b>KENWORTH</b> T680 All Models with Watson & Chalin SL Series Steerable Lift Axle (8,000 to 13,500 lb)	
R	11-19	T880 All Models with Watson & Chalin SL Series Steerable Lift Axle (8,000 to 13,500 lb) <b>OSHKOSH MOTOR TRUCK CO.</b> VARIOUS	
R	14-20	<b>PETERBILT</b> 567 All Models with Watson & Chalin SL Series Steerable Lift Axle (8,000 to 13,500 lb) <b>PIERCE MFG. INC.</b> VARIOUS <b>SAF HOLLAND</b> VARIOUS <b>SPRING VALLEY</b> VARIOUS <b>WATSON &amp; CHALIN MFG. INC.</b> VARIOUS <b>WESTPORT AXLE CORP.</b> VARIOUS	

<b>665472</b>	W		<b>INGERSALL MACHINE</b> VARIOUS
---------------	---	--	----------------------------------

## 89000 Series, Specialty Shock

Shock	POP	Alternative No.	MTG Acc. Supplied
Pos.	Year	Application	
<b>665937</b>	W		
R		<b>CRANE CARRIER</b> VARIOUS <b>REYCO SUSPENSION</b> VARIOUS <b>RIDEWELL CORP.</b> VARIOUS	

## Numerical listing

Shock	POP	Alternative No.	MTG Acc. Supplied
Pos.	Year	Application	

**COMPETITIVE & O.E.M. INTERCHANGE LIST**  
**Lista de Intercambios contra Competidores y Equipo Original.**  
**Liste dinterchange de produits compititifs & dquipement original (OEM)**

**ABC BUS**

Abc bus	Gabriel	Upgrade	Abc bus	Gabriel	Upgrade	Abc bus	Gabriel	Upgrade	Abc bus	Gabriel	Upgrade
050134513	85732		12L-5-72	85709		12L588	85729		624313790	85708	
12J-5-10	85733		12L-5-88	85729		3166657	85700		624314040	85708	
12J510	85733		12L5114	85727		6243-13790	85708		680323	85700	
12L-5-114	85727		12L572	85709		6243-14040	85708				

**ACDelco**

AcDelco	Gabriel	Upgrade	AcDelco	Gabriel	Upgrade	AcDelco	Gabriel	Upgrade	AcDelco	Gabriel	Upgrade
13329507	G51982		501-92	143204		504-505	49107		507-5	89422	
13345954	G51971		503-141	G55591		504-508	49122		507-6	85314	89425
15058617	G64014		503-172	G55661		504-510	49128		507-6	89425	
18041239	G63676		503-173	G55662		504-511	49131		507-7	85301	
19165214	G63869		503-195	G55697		504-512	49135		507-8	85301	
19172143	G51728		503-196	G55698		504-516	49152		507-9	85700	
19177778	G51718		503-248	G55772		504-517	49155		508-13	85012	89413
19203623	G51746		503-278	G55820		504-518	49157		508-13	89413	
19235162	G51736		503-280	G55825		504-520	49162		508-14	83216	
19241342	G56809		503-285	G55856		504-531	49203		508-14	85012	89413
19294056	G56726		503-322	G55948		504-534	49212		508-14	89413	
19294309	G57022		503-323	G55949		504-535	43162		508-15	83216	
19294310	G56929		503-338	G55999		504-535	49213		508-16	83308	
19294314	G57051		503-340	G56700		504-537	49215		508-17	83312	89409
19294318	G57013		503-341	G56701		504-539	49218		508-17	89409	
19294319	G57014		503-353	G56718		504-547	49228		508-18	83309	
19294320	G56948		503-389	G55892		504-547	49255		508-19	83314	
19294321	G56948		503-589	G56509		504-549	49230		508-20	83207	89407
19294322	G56950		503-599	G51746		504-550	49231		508-20	89407	
19294323	G56949		503-615	G56773		504-554	49235		508-21	83214	
19294325	G56951		503-616	G56774		504-557	49304		508-23	83225	
19294330	G57048		503-637	G56809		504-562	49311		508-24	83215	
19294331	G57047		503-638	G56810		504-564	49334		508-26	83203	89436
19294350	G52013		503-662	G56886		504-579	49254		508-26	85030	89440
19294353	G52026		503-663	G56887		505-520	G55825		508-26	89436	
19307626	G51850		503-664	G52013		506-253	G55698		508-26	89440	
19324428	G57048		503-665	G52014		506-310	G52014		508-28	83207	89407
19324429	G57047		503-666	G52025		506-657	G52246		508-28	89407	
19325297	G52278		503-667	G52026		506-658	G52245		508-29	85030	89440
19325298	G52279		503-668	G52027		506-687	G52013		508-29	89440	
19359121	G52395		503-677	G51759		506-749	G52281		508-3	83400	
19359122	G52396		503-681	G52125		506-753	G52280		508-30	85005	89430
19359125	G52494		503-682	G52116		506-801	G56886		508-30	89430	
19359126	G52495		503-683	G52127		506-803	G56887		508-35	G63306	
22737716	G52395		503-684	G52128		506-806	G52395		508-39	G63347	
22737717	G52396		503-685	G51904		506-807	G52396		508-42	G63353	
22737724	G51975		503-686	G51871		507-1	85304		508-464	G63676	
501-10	143057		503-687	G51850		507-10	85711		508-47	G63350	
501-13	83318		503-688	G51891		507-11	85308	89422	508-48	G63409	
501-187	142526		503-689	G51870		507-11	89422		508-5	G63359	
501-192	142530		503-699	G52244		507-13	85704		508-5	G63360	
501-2	143058		503-700	G52278		507-16	85702		508-50	G63299	
501-209	142547		503-701	G52279		507-17	85304		508-52	G63405	
501-218	142836		503-702	G52280		507-18	85305		508-52	G63419	
501-318	142561		503-703	G52281		507-19	85700		508-56	G63605	
501-358	143073		503-705	G51949		507-2	85302	89420	508-57	83123	89405
501-386	143281		503-708	G52395		507-2	89420		508-57	89405	
501-4	143061		503-709	G52396		507-3	85307				
501-5	143059		503-710	G52494		507-4	85303	89422			
501-75	83303		503-711	G52495		507-4	89422				
501-82	142249		504-501	49255		507-5	85308	89422			

**Important Note:** Competitive Interchanges are to be used for stocking purposes only. Where multiple crosses are identified, please reference the applications section of this catalog. / **Remarque importante:** Les interchanges concurrentiels ne s'utilisent qu'aux fins de stocks. Dans le cas de références multiples, consulter la section des applications du catalogue. / **Nota importante:** Dans le cas de referencias multiples, consultar la sección de aplicaciones del catálogo. / **Nota importante:** Se pueden usar intercambios competitivos para propósitos de almacenamiento solamente. Cuando se identifican intercambios múltiples, consulte la sección de aplicaciones de este catálogo.

**COMPETITIVE & O.E.M. INTERCHANGE LIST**  
**Lista de Intercambios contra Competidores y Equipo Original.**  
**Liste d'interchange de produits complitifs & d'equpement original (OEM)**

**ACDelco... cont'd**

Accelco	Gabriel	Upgrade	Accelco	Gabriel	Upgrade	Accelco	Gabriel	Upgrade	Accelco	Gabriel	Upgrade
508-59	G63183		520-168	81446		520-372	82602		530-130	G63349	
508-68	83209	89414	520-17	61517		520-378	82609		530-130	G63422	
508-68	85006		520-175	81478		520-386	82618		530-133	G63355	
508-68	89414		520-176	81482		520-39	61541		530-133	G63421	
508-71	83314		520-177	81481		520-392	61664		530-134	G63357	
508-72	G63386		520-178	81490		520-393	81869		530-147	G63403	
508-74	G63511		520-179	81494		520-394	69622		530-147	G63413	
508-78	83400		520-180	81492		520-394	81880		530-151	G63366	
508-79	G63424		520-182	81495		520-396	61675		530-156	G63421	
508-80	G63425		520-183	81496		520-398	61777		530-157	G63422	
508-82	G63410		520-184	81484		520-40	61542		530-158	G63423	
508-86	83136		520-186	81507		520-401	61687		530-159	G63424	
508-87	85071		520-187	81514		520-403	61683		530-16	69715	
508-9	85000	89436	520-188	81516		520-406	61690		530-160	G63425	
508-9	89436		520-19	61519		520-407	61684		530-161	G63426	
508-90	83136		520-194	81540		520-408	61685		530-17	69714	
509-606	14017		520-196	81548		520-409	61717		530-175	G63375	
509-607	14018		520-197	81549		520-41	61543		530-176	G63454	
509-610	14040		520-199	81553		520-410	61718		530-189	G63488	
509-611	6801SE		520-2	61501		520-42	61544		530-189	G63609	
509-612	6802SE		520-205	81559		520-426	81930		530-190	G63489	
509-613	6803SE		520-206	81560		520-427	81318		530-193	G63492	
509-626	6853SE		520-210	81582		520-428	81873		530-2	69604	
519-15	43111		520-214	81667		520-429	81920		530-20	69675	
519-2	43048		520-215	81668		520-431	81922		530-201	G63403	
519-21	43162		520-22	61522		520-432	81924		530-202	G63411	
519-22	43163		520-220	81675		520-433	81925		530-203	G63394	
519-29	43180		520-227	81713		520-5	61504		530-211	G63511	
519-3	43049		520-238	81750		520-53	61555		530-223	G63609	
519-30	43181		520-24	61524		520-58	61560		530-235	G63625	
519-31	34036		520-25	61525		520-61	61565		530-238	G63638	
519-32	34051		520-261	82003		520-65	61575		530-243	G63662	
519-36	34073		520-268	82010		520-7	61506		530-247	G63675	
519-5	43060		520-27	61528		520-85	61600		530-251	G63683	
519-5	49152		520-292	82034		520-89	61605		530-253	G63690	
520-1	61500		520-293	82035		520-9	61508		530-267	G63721	
520-100	61616		520-298	82040		520-99	61615		530-268	G63722	
520-115	61641		520-30	61531		525-16	58403		530-274	G63902	
520-116	61642		520-300	82047		525-21	58412		530-279	G63907	
520-117	61643		520-310	82060		525-25	58421		530-281	G63909	
520-132	61659		520-319	82070		525-26	58422		530-295	G63776	
520-135	61663		520-323	82075		525-27	58423		530-298	G63783	
520-138	81039		520-324	82076		525-33	58488		530-3	69606	
520-141	81095		520-326	82079		525-34	58489		530-300	G63799	
520-142	81096		520-331	82086		525-36	58609		530-301	G63803	
520-145	81113		520-332	82087		525-42	58638		530-311	G63817	
520-146	81164		520-34	61535		525-44	58662		530-312	G63818	
520-147	81147		520-343	82109		525-55	58901		530-315	69625	
520-150	81242		520-344	82110		525-59	58803		530-324	G63829	
520-152	81270		520-35	61536		525-6	58357		530-335	G63842	
520-154	81340		520-350	82118		525-66	58817		530-336	G63844	
520-157	81394		520-353	82125		525-68	58930		530-338	G63847	
520-16	61516		520-360	82138		530-1	69600		530-37	69795	
520-164	81510		520-365	82151		530-10	69676		530-387	G63866	
520-165	81082		520-37	61539		530-129	G63347		530-393	G63868	
520-168	69675		520-371	82601		530-129	G63423		530-394	G63869	

**Important Note:** Competitive Interchanges are to be used for stocking purposes only. Where multiple crosses are identified, please reference the applications section of this catalog. / **Remarque importante:** Les interchanges concurrentiels ne s'utilisent qu'aux fins de stocks. Dans le cas de rferences multiples, consulter la section des applications du catalogue. / **Nota importante:** Dans le cas de rferences multiples, consulter la section des applications du catalogue. / **Nota importante:** Se pueden usar intercambios competitivos para propósitos de almacenamiento solamente. Cuando se identifican intercambios múltiples, consulte la sección de aplicaciones de este catálogo.

**COMPETITIVE & O.E.M. INTERCHANGE LIST**  
**Lista de Intercambios contra Competidores y Equipo Original.**  
**Liste dinterchange de produits comptitifs & dquipement original (OEM)**

**ACDelco... cont'd**

AcDelco	Gabriel	Upgrade	AcDelco	Gabriel	Upgrade	AcDelco	Gabriel	Upgrade	AcDelco	Gabriel	Upgrade
530-395	G63884		540-5018	77783		88945315	G63413		901-085	143461	
530-4	69622		540-5023	77422		88945329	G63426		901-086	143462	
530-402	G63882		540-5024	77423		88945361	G63492		903-003RS	G56726	
530-403	G63879		540-5027	77454		88945403	G63625		903-004RS	G56927	
530-407	G51718		540-5032	77488		88945411	G63662		903-005RS	G56927	
530-42	69811		540-5033	77488		88945415	G63675		903-005RS	G56928	
530-423	G63872		540-5033	77489		88945417	G63678		903-012RS	G57060	
530-439	G51736		540-5040	77609		88945453	G63928		903-014RS	G56938	
530-441	G63893		540-5043	77638		88945468	G63799		903-015RS	G57022	
530-442	G63896		540-5046	77662		88945652	G55661		903-016RS	G56929	
530-443	G63897		540-5062	77783		88945653	G55662		903-020RS	G57051	
530-448	G63959		540-5063	77803		88945675	G55697		903-024RS	G57013	
530-449	G63894		540-5069	77817		88945728	G55772		903-025RS	G57014	
530-450	G63895		540-5077	77907		88945758	G55820		903-026RS	G56948	
530-454	69590		540-5078	77909		88945760	G55825		903-027RS	G56948	
530-455	G64014		540-5088	77953		88945765	G55856		903-028RS	G56950	
530-456	69587		540-514	G51904		88945818	G55999		903-029RS	G56949	
530-457	69589		550-13	85005	89430	88963960	G55892		903-031RS	G56951	
530-466	G64015		550-13	89430		88973940	G52014		903-032RS	G56924	
530-467	70031		550-73	83303		88973942	G52013		903-033RS	G56925	
530-469	G64040		550-73	85005	89430	88974638	G51736		903-035RS	G57000	
530-476	G64101		550-73	89430		88991409	G63882		903-035RS	G57023	
530-479	70059		550-75	83303		901-015	142249		903-038RS	G57048	
530-480	G51971		550-77	83221		901-016	142245		903-039RS	G57047	
530-480	G51975		560-200	G51871		901-038	142526		903-040RS	G57125	
530-481	G64140		560-201	G51871		901-039	142526		903-041RS	G57070	
530-482	G511030		560-545	69845		901-042	142530		903-041RS	G57122	
530-483	G51982		560-596	G51736		901-052	143073		903-042RS	G57069	
530-5	69624		560-681	G51971		901-053	143074		903-042RS	G57121	
530-6	69632		560-691	G51975		901-064	143058		903-043RS	G57142	
530-9	69724		560-809	G52494		901-064	143059		903-044RS	G57111	
540-127	69898		560-810	G52495		901-071	143094		903-045RS	G57110	
540-144	G64014		560-811	G52494		901-073	143425		903-048RS	G57067	
540-404	G51718		560-812	G52495		901-074	143323		903-049RS	G57068	
540-5001	75676		88875108	G56887		901-075	143316		92195485	G51916	
540-5008	77403		88945297	G63347		901-076	143061		92244058	G52281	
540-5010	77375		88945297	G63423		901-078	143063		92244059	G52280	
540-5018	77412		88945315	G63403		901-079	143064				

**ACF Brill Bus**

Acf brill bus	Gabriel	Upgrade	Acf brill bus	Gabriel	Upgrade	Acf brill bus	Gabriel	Upgrade	Acf brill bus	Gabriel	Upgrade
610513	85307		641521	85308	89422	649648	89422		661732	83215	
631237	85308	89422	641521	89422		659129	85303	89422	661733	83225	
631237	89422		649648	85308	89422	659129	89422		995891	85307	

**Advance Mixer**

Advance mixer	Gabriel	Upgrade	Advance mixer	Gabriel	Upgrade	Advance mixer	Gabriel	Upgrade	Advance mixer	Gabriel	Upgrade
12111 ADV	646155		13883	85334		14626 ADV	89414		85334	85334	
13424 ADV	83207	89407	13883 ADV	85334		23458 ADV	83112				
13424 ADV	89407		14626 ADV	83209	89414	680087	85334				

**Allco Trailer**

Allco trailer	Gabriel	Upgrade	Allco trailer	Gabriel	Upgrade	Allco trailer	Gabriel	Upgrade	Allco trailer	Gabriel	Upgrade
727602	83122	89406	727602	89406							

**Alliance**

Alliance	Gabriel	Upgrade	Alliance	Gabriel	Upgrade	Alliance	Gabriel	Upgrade	Alliance	Gabriel	Upgrade
ABP N32 G900001	85724	89443	ABP N32 G900003	85918	89449	ABP N32 G900005	85001	89410			
ABP N32 G900001	89443		ABP N32 G900003	89449		ABP N32 G900005	89410				
ABP N32 G900002	83203	89436	ABP N32 G900004	85320	89429	ABP N32 G900006	83456	89447			
ABP N32 G900002	89436		ABP N32 G900004	89429		ABP N32 G900006	89447				

**Important Note:** Competitive Interchanges are to be used for stocking purposes only. Where multiple crosses are identified, please reference the applications section of this catalog. / **Remarque importante:** Les interchanges concurrentiels ne s'utilisent qu'aux fins de stocks. Dans le cas de références multiples, consulter la section des applications du catalogue. / **Nota importante:** En el caso de referencias múltiples, consultar la sección de aplicaciones del catálogo. / **Nota importante:** Se pueden usar intercambios competitivos para propósitos de almacenamiento solamente. Cuando se identifican intercambios múltiples, consulte la sección de aplicaciones de este catálogo.

**COMPETITIVE & O.E.M. INTERCHANGE LIST**  
**Lista de Intercambios contra Competidores y Equipo Original.**  
**Liste dinterchange de produits comptitifs & dquipement original (OEM)**

**Alliance... cont'd**

Alliance	Gabriel	Upgrade	Alliance	Gabriel	Upgrade	Alliance	Gabriel	Upgrade	Alliance	Gabriel	Upgrade
ABP N32 G900007	83125		ABP N32 G900047	85900		ABP N32 O900004	89429		ABP N32 O900040	85061	89450
ABP N32 G900008	83001		ABP N32 G900049	85957		ABP N32 O900005	85001	89410	ABP N32 O900041	85937	
ABP N32 G900009	85006		ABP N32 G900050	83135		ABP N32 O900006	89410		ABP N32 O900043	85316	89426
ABP N32 G900010	85013	89414	ABP N32 G900051	83317		ABP N32 O900006	83456	89447	ABP N32 O900043	89426	
ABP N32 G900010	89414		ABP N32 G900053	85938		ABP N32 O900006	89447		ABP N32 O900044	85954	
ABP N32 G900011	85323	89436	ABP N32 G900054	85005	89430	ABP N32 O900007	83125		ABP N32 O900046	85045	
ABP N32 G900011	89436		ABP N32 G900054	89430		ABP N32 O900008	83001		ABP N32 O900047	85900	
ABP N32 G900012	83038		ABP N32 G900055	83008		ABP N32 O900009	85006		ABP N32 O900049	85957	
ABP N32 G900013	85931	89458	ABP N32 G900056	83126	89430	ABP N32 O900010	85013	89414	ABP N32 O900050	83135	
ABP N32 G900013	89458		ABP N32 G900056	89430		ABP N32 O900010	89414		ABP N32 O900051	83317	
ABP N32 G900014	83009		ABP N32 G900058	85936	89456	ABP N32 O900011	85323	89436	ABP N32 O900053	85938	
ABP N32 G900015	83128	89436	ABP N32 G900058	89456		ABP N32 O900011	89436		ABP N32 O900054	85005	89430
ABP N32 G900015	89436		ABP N32 G900061	85072		ABP N32 O900012	83038		ABP N32 O900054	89430	
ABP N32 G900016	85319	89428	ABP N32 G900063	83031		ABP N32 O900013	85931	89458	ABP N32 O900055	83008	
ABP N32 G900016	89428		ABP N32 G900068	85047	89435	ABP N32 O900013	89458		ABP N32 O900056	83126	89430
ABP N32 G900017	85736		ABP N32 G900068	89435		ABP N32 O900014	83009		ABP N32 O900056	89430	
ABP N32 G900018	83021		ABP N32 G900069	83147		ABP N32 O900015	83128	89436	ABP N32 O900058	85936	89456
ABP N32 G900019	85062	89408	ABP N32 G900071	83112		ABP N32 O900015	89436		ABP N32 O900058	89456	
ABP N32 G900019	89408		ABP N32 G900072	85656		ABP N32 O900016	85319	89428	ABP N32 O900061	85072	
ABP N32 G900020	85067	89451	ABP N32 G900073	85058	89431	ABP N32 O900016	89428		ABP N32 O900063	83031	
ABP N32 G900020	89451		ABP N32 G900073	89431		ABP N32 O900017	85736		ABP N32 O900068	85047	89435
ABP N32 G900021	85070	89459	ABP N32 G900074	85933	89454	ABP N32 O900018	83021		ABP N32 O900068	89435	
ABP N32 G900021	89459		ABP N32 G900074	89454		ABP N32 O900019	85062	89408	ABP N32 O900069	83147	
ABP N32 G900022	85003	89411	ABP N32 G900075	85919		ABP N32 O900019	89408		ABP N32 O900071	83112	
ABP N32 G900022	89411		ABP N32 G900076	85012	89413	ABP N32 O900020	85067	89451	ABP N32 O900072	85656	
ABP N32 G900024	85901		ABP N32 G900076	89413		ABP N32 O900020	89451		ABP N32 O900073	85058	89431
ABP N32 G900025	83017		ABP N32 G900077	85958		ABP N32 O900021	85070	89459	ABP N32 O900073	89431	
ABP N32 G900027	85331		ABP N32 G900078	85088		ABP N32 O900021	89459		ABP N32 O900074	85933	89454
ABP N32 G900028	85000	89436	ABP N32 G900079	85934		ABP N32 O900022	85003	89411	ABP N32 O900074	89454	
ABP N32 G900028	89436		ABP N32 G900080	85061	89450	ABP N32 O900022	89411		ABP N32 O900075	85919	
ABP N32 G900030	83127		ABP N32 G900081	85920	89503	ABP N32 O900024	85901		ABP N32 O900076	85012	89413
ABP N32 G900031	85311	89424	ABP N32 G900081	89503		ABP N32 O900025	83017		ABP N32 O900076	89413	
ABP N32 G900031	89424		ABP N32 G900082	85738		ABP N32 O900027	85331		ABP N32 O900077	85958	
ABP N32 G900032	85066	89448	ABP N32 G900083	85029		ABP N32 O900028	85000	89436	ABP N32 O900078	85088	
ABP N32 G900032	89448		ABP N32 G900085	83207	89407	ABP N32 O900028	89436		ABP N32 O900079	85934	
ABP N32 G900033	85023	89415	ABP N32 G900085	89407		ABP N32 O900029	646155		ABP N32 O900080	85061	89450
ABP N32 G900033	89415		ABP N32 G900086	85064		ABP N32 O900030	83127		ABP N32 O900081	85920	89503
ABP N32 G900034	85310	89423	ABP N32 G900087	85030	89440	ABP N32 O900031	85311	89424	ABP N32 O900081	89503	
ABP N32 G900034	89423		ABP N32 G900087	89440		ABP N32 O900031	89424		ABP N32 O900082	85738	
ABP N32 G900035	85924	89457	ABP N32 G900088	83035		ABP N32 O900032	85066	89448	ABP N32 O900083	85029	
ABP N32 G900035	89457		ABP N32 G900089	85932	89453	ABP N32 O900032	89448		ABP N32 O900084	85959	
ABP N32 G900036	83124	89407	ABP N32 G900089	89453		ABP N32 O900033	85023	89415	ABP N32 O900085	83207	89407
ABP N32 G900036	89407		ABP N32 G900090	85053	89442	ABP N32 O900033	89415		ABP N32 O900085	89407	
ABP N32 G900037	85052		ABP N32 G900090	89442		ABP N32 O900034	85310	89423	ABP N32 O900086	85064	
ABP N32 G900038	85069	89455	ABP N32 G900091	83396		ABP N32 O900034	89423		ABP N32 O900087	85030	89440
ABP N32 G900038	89455		ABP N32 G900094	85084	89460	ABP N32 O900035	85924	89457	ABP N32 O900087	89440	
ABP N32 G900039	85033	89427	ABP N32 G900094	89460		ABP N32 O900035	89457		ABP N32 O900088	83035	
ABP N32 G900039	89427		ABP N32 O900001	85724	89443	ABP N32 O900036	83124	89407	ABP N32 O900089	85932	89453
ABP N32 G900040	85061	89450	ABP N32 O900001	89443		ABP N32 O900036	89407		ABP N32 O900089	89453	
ABP N32 G900041	85937		ABP N32 O900002	83203	89436	ABP N32 O900037	85052		ABP N32 O900090	85053	89442
ABP N32 G900043	85316	89426	ABP N32 O900002	89436		ABP N32 O900038	85069	89455	ABP N32 O900091	83396	
ABP N32 G900043	89426		ABP N32 O900003	85918	89449	ABP N32 O900038	89455		ABP N32 O900092	83163	
ABP N32 G900044	85954		ABP N32 O900003	89449		ABP N32 O900039	85033	89427	ABP N32 O900093	83137	
ABP N32 G900046	85045		ABP N32 O900004	85320	89429	ABP N32 O900039	89427				

**Important Note:** Competitive Interchanges are to be used for stocking purposes only. Where multiple crosses are identified, please reference the applications section of this catalog. / **Remarque importante:** Les interchanges concurrentiels ne s'utilisent qu'aux fins de stocks. Dans le cas de références multiples, consulter la section des applications du catalogue. / **Nota importante:** Dans le cas de referencias multiples, consultar la sección de aplicaciones del catálogo. / **Nota importante:** Se pueden usar intercambios competitivos para propósitos de almacenamiento solamente. Cuando se identifican intercambios múltiples, consulte la sección de aplicaciones de este catálogo.



**COMPETITIVE & O.E.M. INTERCHANGE LIST**  
**Lista de Intercambios contra Competidores y Equipo Original.**  
**Liste dinterchange de produits compititifs & dquipement original (OEM)**

**AM General**

Am general	Gabriel	Upgrade	Am general	Gabriel	Upgrade	Am general	Gabriel	Upgrade	Am general	Gabriel	Upgrade
3166657	85700		5957136	85700		5979484	85302	89420	5982537	85700	
4975501	85700		5969438	85700		5979484	89420				
5565748	85700		5978712	85700		5979574	85700				

**Arvin Meritor**

Arvin meritor	Gabriel	Upgrade	Arvin meritor	Gabriel	Upgrade	Arvin meritor	Gabriel	Upgrade	Arvin meritor	Gabriel	Upgrade
085009	85009		680337	85708		727639	83312	89409	728617	89430	
085014	85014		680347	85732		727639	89409		728618	85006	
085321	85321		680464	85005	89430	727641	83314		728619	85007	
654907	85000	89436	680464	89430		727645	83318		728621	85009	
654907	89436		680518	85700		727671	83613		728622	85010	
654958	83164		680584	85938		727672	83242		728624	85012	89413
665044	83209	89414	680671	85708		728601	85001	89410	728624	89413	
665044	89414		695180	85705	89447	728601	89410		728625	85013	89414
665724	85000	89436	695180	89447		728603	85003	89411	728625	89414	
665724	89436		695214	85722		728603	89411		728628	85314	89425
665746	85000	89436	695348	87018		728604	85300	89419	728628	89425	
665746	89436		727600	89402		728604	89419		728631	85029	
665760	85045		727607	83207	89407	728606	85302	89420	728632	85030	89440
665769	85052		727607	89407		728606	89420		728632	89440	
665804	85939		727609	83209	89414	728608	85304		728635	85318	
671091	85069	89455	727609	89414		728609	85305		728639	85026	
671091	89455		727614	83214		728611	85307		728640	85027	
671092	85012	89413	727615	83215		728612	85308	89422	728800	85711	
671092	89413		727616	83216		728612	89422		728806	85736	
671507	87015		727619	83219		728614	85310	89423	728812	85705	89447
671707	85323	89436	727625	83225		728614	89423		728812	89447	
671707	89436		727628	83301		728615	85311	89424	7805-N-1002	85329	
680102	85712		727630	83303		728615	89424		7805-S-1007	85329	
680322	85704		727635	83308		728616	85004		7805N1002	85329	
680331	85702		727636	83309		728617	85005	89430	7805S1007	85329	

**Aurora Parts and Service**

Aurora parts and service	Gabriel	Upgrade	Aurora parts and service	Gabriel	Upgrade	Aurora parts and service	Gabriel	Upgrade	Aurora parts and service	Gabriel	Upgrade
PROSH85724	85724	89443									

**Autocar LLC.**

Autocar llc.	Gabriel	Upgrade	Autocar llc.	Gabriel	Upgrade	Autocar llc.	Gabriel	Upgrade	Autocar llc.	Gabriel	Upgrade
03-1106460	85005	89430	60657-003L	85072		60670005L	83137		660186	83216	
03-1106460	89430		60657003	85072		60675-003	85976		727602	83122	89406
031106460	85005	89430	60657003L	85072		60675-003L	85976		727602	89406	
031106460	89430		60665-011	85967		60675003	85976		800670	85060	
1011839	83216		60665-013	85965		60675003L	85976		800781	85314	89425
28CFG-910	83216		60665-025	85036	89405	60680-003	83112		800781	89425	
28CFG-910Z	83216		60665-025	89405		60680-003L	83112		8026658	85046	89434
28CFG910	83216		60665-025L	85036	89405	60680-004	83143		8026658	89434	
28CFG910Z	83216		60665-025L	89405		60680-004L	83143		8071524	85024	
28R010	83216		60665011	85967		60680-005	83142		849246	83216	
35901-3201	85024		60665013	85965		60680-005L	83142		A3591004-001	85072	
359013201	85024		60665025	85036	89405	60680003	83112		A3591004001	85072	
37301-3201	85027		60665025	89405		60680003L	83112		A3711405-001	85908	
37301-3202	85026		60665025L	85036	89405	60680004	83143		A3711405001	85908	
373013201	85027		60665025L	89405		60680004L	83143		A3730008-001	85086	
373013202	85026		60670-005	83137		60680005	83142		A3730008001	85086	
3946210	83103		60670-005L	83137		60680005L	83142				
60657-003	85072		60670005	83137		65458PS	85908				

**AUTOMANN**

Automann	Gabriel	Upgrade	Automann	Gabriel	Upgrade	Automann	Gabriel	Upgrade	Automann	Gabriel	Upgrade
A646155	646155		A665937	665937							
A646177	646177		A83021	83021							

**Important Note:** Competitive Interchanges are to be used for stocking purposes only. Where multiple crosses are identified, please reference the applications section of this catalog./ **Remarque importante:** Les interchanges concurrentiels ne s'utilisent qu'aux fins de stocks. Dans le cas de rferences multiples, consulter la section des applications du catalogue./ **Nota importante:** Dans le cas de rferences multiples, consulter la section des applications du catalogue./ **Nota importante:** Se pueden usar intercambios competitivos para propósitos de almacenamiento solamente. Cuando se identifican intercambios múltiples, consulte la sección de aplicaciones de este catálogo.

**COMPETITIVE & O.E.M. INTERCHANGE LIST**  
**Lista de Intercambios contra Competidores y Equipo Original.**  
**Liste dinterchange de produits comptitifs & dquipement original (OEM)**

**AUTOMANN... cont'd**

Automann	Gabriel	Upgrade	Automann	Gabriel	Upgrade	Automann	Gabriel	Upgrade	Automann	Gabriel	Upgrade
A83023	83023		A83175	83175		A85064	85064		A85936	85936	89456
A83024	83024		A83203	83203	89436	A85065	85065		A85937	85937	
A83025	83025		A83207	83207	89407	A85066	85066	89448	A85938	85938	
A83026	83026		A83209	83209	89414	A85067	85067	89451	A85939	85939	
A83028	83028		A83215	83215		A85069	85069	89455	A85954	85954	
A83029	83029		A83312	83312	89409	A85070	85070	89459	A85956	85956	
A83030	83030		A83317	83317		A85072	85072		A85957	85957	
A83031	83031		A83364	83364		A85081	85081		A85958	85958	
A83038	83038		A83391	83391		A85084	85084	89460	A85959	85959	
A83039	83039		A83395	83395		A85086	85086		A85964	85964	
A83040	83040		A83396	83396		A85088	85088		A85967	85967	
A83045	83045		A83456	83456	89447	A85109	85109		A85972	85972	
A83048	83048		A83905	83905		A85119	85119		A85976	85976	
A83049	83049		A83906	83906		A85188	85188		A85977	85977	
A83051	83051		A83907	83907		A85303	85303	89422	A85979	85979	
A83053	83053		A83908	83908		A85308	85308	89422	A85989	85989	
A83054	83054		A83911	83911		A85310	85310	89423	A85994	85994	
A83066	83066		A85000	85000	89436	A85311	85311	89424	A85995	85995	
A83081	83081		A85001	85001	89410	A85316	85316	89426	A86200	86200	
A83101	83101		A85003	85003	89411	A85319	85319	89428	A89407	89407	
A83103	83103		A85005	85005	89430	A85320	85320	89429	A89408	89408	
A83112	83112		A85006	85006		A85323	85323	89436	A89410	89410	
A83123	83123	89405	A85012	85012	89413	A85338	85338		A89411	89411	
A83125	83125		A85013	85013	89414	A85345	85345		A89414	89414	
A83128	83128	89436	A85014	85014		A85639	85639		A89423	89423	
A83130	83130		A85023	85023	89415	A85642	85642		A89424	89424	
A83131	83131		A85026	85026		A85724	85724	89443	A89426	89426	
A83134	83134		A85029	85029		A85738	85738		A89427	89427	
A83135	83135		A85030	85030	89440	A85739	85739		A89436	89436	
A83136	83136		A85033	85033	89427	A85900	85900		A89443	89443	
A83137	83137		A85036	85036	89405	A85909	85909		A89451	89451	
A83140	83140		A85045	85045		A85918	85918	89449	A89455	89455	
A83142	83142		A85046	85046	89434	A85920	85920	89503	A89460	89460	
A83143	83143		A85052	85052		A85923	85923	89458	A89503	89503	
A83144	83144		A85055	85055	89439	A85924	85924	89457	A90131	83062	
A83147	83147		A85058	85058	89431	A85927	85927		A99605	85109	
A83150	83150		A85060	85060		A85928	85928		A99769	83081	
A83163	83163		A85061	85061	89450	A85929	85929		AG63809	G63809	
A83166	83166		A85062	85062	89408	A85931	85931	89458			
A83169	83169		A85063	85063		A85934	85934				

**Batco**

Batco	Gabriel	Upgrade	Batco	Gabriel	Upgrade	Batco	Gabriel	Upgrade	Batco	Gabriel	Upgrade
1083203	83203	89436	1083225	83225		1085007	85007		1085311	85311	89424
1083203	89436		1083310	83221		1085300	85300	89419	1085311	89424	
1083204	83204		1083317	83317		1085300	89419		1087001	85734	
1083207	83207	89407	1085003	85003	89411	1085301	85301		1087006	85736	
1083207	89407		1085003	89411		1085305	85305				
1083209	83209	89414	1085005	85005	89430	1085308	85308	89422			
1083209	89414		1085005	89430		1085308	89422				

**Beck Bus**

Beck bus	Gabriel	Upgrade	Beck bus	Gabriel	Upgrade	Beck bus	Gabriel	Upgrade	Beck bus	Gabriel	Upgrade
14QK-140	85304		14QK-2102	85304		14QK140	85304		14QK2102	85304	

**Benson Truck Bodies Inc.**

Benson truck bodies inc.	Gabriel	Upgrade	Benson truck bodies inc.	Gabriel	Upgrade	Benson truck bodies inc.	Gabriel	Upgrade	Benson truck bodies inc.	Gabriel	Upgrade
90044089	83124	89407	A-20002	85000	89436	A20002	85000	89436			
90044089	89407		A-20002	89436		A20002	89436				

**Important Note:** Competitive Interchanges are to be used for stocking purposes only. Where multiple crosses are identified, please reference the applications section of this catalog. / **Remarque importante:** Les interchanges concurrentiels ne s'utilisent qu'aux fins de stocks. Dans le cas de références multiples, consulter la section des applications du catalogue. / **Nota importante:** Dans le cas de références multiples, consulter la section des applications du catalogue. / **Nota importante:** Se pueden usar intercambios competitivos para propósitos de almacenamiento solamente. Cuando se identifican intercambios múltiples, consulte la sección de aplicaciones de este catálogo.

**COMPETITIVE & O.E.M. INTERCHANGE LIST**  
**Lista de Intercambios contra Competidores y Equipo Original.**  
**Liste dinterchange de produits comptitifs & dquipement original (OEM)**

**Benson Truck Bodies Inc.... cont'd**

**Bering Truck Corp.**

Bering truck corp.	Gabriel	Upgrade	Bering truck corp.	Gabriel	Upgrade	Bering truck corp.	Gabriel	Upgrade	Bering truck corp.	Gabriel	Upgrade
47902-24	83137		4790224	83137							

**Berkshire Coach**

Berkshire coach	Gabriel	Upgrade	Berkshire coach	Gabriel	Upgrade	Berkshire coach	Gabriel	Upgrade	Berkshire coach	Gabriel	Upgrade
8C24-18045-DA	G63622		8C2418080DB	G63623		8C2Z18124D	G63622		ASH-1154	G63622	
8C24-18080-DB	G63623		8C2Z-18124-D	G63622		8C2Z18125D	G63623		ASH1136	G63623	
8C2418045DA	G63622		8C2Z-18125-D	G63623		ASH-1136	G63623		ASH1154	G63622	

**Bilstein**

Bilstein	Gabriel	Upgrade	Bilstein	Gabriel	Upgrade	Bilstein	Gabriel	Upgrade	Bilstein	Gabriel	Upgrade
14-186629	85125		24-153256	85124		B46-1725	85029		F4-B46-1725-H2	85029	
24-015943	85013	89414	24-186414	85029		B46-1732	85030	89440	F4-B46-1732-H1	85030	89440
24-015943	89414		B46-1594	85013	89414	B46-1732	89440		F4-B46-1732-H1	89440	
24-017329	85030	89440	B46-1594	85030	89440	B46-2151	85007		F4-BE5-B492-H0	85125	
24-017329	89440		B46-1594	89414		F4-B46-1594-H0	85013	89414	F4-BE5-F324-H0	85125	
24-153249	85125		B46-1594	89440		F4-B46-1594-H0	89414		F4-BE5-F325-H0	85124	

**Blue Bird**

Blue bird	Gabriel	Upgrade	Blue bird	Gabriel	Upgrade	Blue bird	Gabriel	Upgrade	Blue bird	Gabriel	Upgrade
00020317	85036	89405	1707405	89430		4759272	89447		609180	85304	
00020317	89405		1722222	85013	89414	4760958	85086		60998-001	85006	
00085991	85006		1722222	89414		481700131438	85919		60998-002	85919	
00110808	83124	89407	1746163	85006		481700131440	85919		60998-002L	85919	
00110808	89407		1750793	85712		58913-007	85959		60998-003	85006	
00119797	85959		1962422	85304		58913-007L	85959		60998001	85006	
00119798	85106		1962430	83207	89407	58913-008	85959		60998002	85919	
0014605	85036	89405	1962430	89407		58913-008L	85959		60998002L	85919	
0014605	89405		2021459	85012	89413	58913-009	85959		60998003	85006	
0014985	83137		2021459	89413		58913-009L	85959		614958	85307	
0015222	85919		23106-01	89430		58913-010	85106		614974	85304	
0020326	85976		300-0614966	85307		58913-010L	85106		65992-003	85959	
0040015	85919		300-0614974	85304		58913-011	85959		65992-004	85106	
0055008	85959		300-0823047	85736		58913-011L	85959		65992003	85959	
0055017	85959		300-0823054	85304		58913007	85959		65992004	85106	
00614966	85307		300-09612284	85734		58913007L	85959		671933	85919	
0075916	85086		300-1316546	85006		58913008	85959		680102	85712	
0085990	85959		300-1317767	85029		58913008L	85959		680155	85712	
0088035	85090		3000614966	85307		58913009	85959		680667	89447	
0106303	85106		3000614974	85304		58913009L	85959		680783	85304	
01722214	85030	89440	3000823047	85736		58913010	85106		70317	89402	
01722214	89440		3000823054	85304		58913010L	85106		70397	85006	
0523047	85736		30009612284	85734		58913011	85959		7805-M-1001	85919	
060665-003	83137		3001316546	85006		58913011L	85959		7805-N-1002	85329	
060665-004	85036	89405	3001317767	85029		59057-001	83137		7805-S-1007	85329	
060665-004	89405		303-1350628	85712		59057-002	85036	89405	7805M1001	85919	
0823054	85304		3031350628	85712		59057-002	89405		7805N1002	85329	
1004167	85712		305-0961284	85734		59057001	83137		7805S1007	85329	
1217934	85304		3050961284	85734		59057002	85036	89405	87001-01A	85734	
1316546	85006		471700000428	85006		59057002	89405		8700101A	85734	
1317767	85029		471700000430	85006		59483-000	85919		8C24-18045-DA	G63622	
1526417	85052		471700000456	85959		59483000	85919		8C24-18080-DB	G63623	
1658533	85010		471700000460	85090		60665-004	85036	89405	8C2418045DA	G63622	
1668731	85029		471700000460	85959		60665-004	89405		8C2418080DB	G63623	
1668722	85030	89440	471700000464	85090		60665-005	85919		8C2Z-18124-D	G63622	
1668722	89440		471700002919	85106		60665-005L	85919				
1668730	85013	89414	471700002920	85106		60665003	83137				
1668730	89414		471700131545	85006		60665005	85919				
1707405	85005	89430	471700131550	85006		60665005L	85919				

**Important Note:** Competitive Interchanges are to be used for stocking purposes only. Where multiple crosses are identified, please reference the applications section of this catalog. / **Remarque importante:** Les interchanges concurrentiels ne s'utilisent qu'aux fins de stocks. Dans le cas de rfrences multiples, consulter la section des applications du catalogue. / **Nota importante:** En el caso de rfrences mltiples, consultar la seccion de aplicaciones del catalogo. / **Nota importante:** Se pueden usar intercambios competitivos para propsitos de almacenamiento solamente. Cuando se identifican intercambios mltiples, consulte la seccion de aplicaciones de este catalogo.

**COMPETITIVE & O.E.M. INTERCHANGE LIST**  
**Lista de Intercambios contra Competidores y Equipo Original.**  
**Liste dinterchange de produits comptitifs & dquipement original (OEM)**

**Blue Bird... cont'd**

Blue bird	Gabriel	Upgrade	Blue bird	Gabriel	Upgrade	Blue bird	Gabriel	Upgrade	Blue bird	Gabriel	Upgrade
8C2Z-18125-D	G63623		90044448	85051		A4890	85712		ASH1136	G63623	
8C2Z18124D	G63622		90044915	83127		AMS65109	85058	89431	ASH1154	G63622	
8C2Z18125D	G63623		90045083	85910		AMS65109	89431		AT-163G	G63622	
90-1813	85712		901813	85712		AMS65110	85005	89430	AT-164G	G63623	
90-1951-SP1	85734		901951SP1	85734		AMS65110	89430		AT163G	G63622	
90-1968	85712		901968	85712		AMS65119	85029		AT164G	G63623	
90-1968	85720		901968SP1	85712		ASH-1136	G63623				
90-1968-SP1	85712		A-4890	85712		ASH-1154	G63622				

**Boystun Equipment Manufacturing**

Boystun equipment manufacturing	Gabriel	Upgrade	Boystun equipment manufacturing	Gabriel	Upgrade	Boystun equipment manufacturing	Gabriel	Upgrade	Boystun equipment manufacturing	Gabriel	Upgrade
1253069B000	85005	89430	1253069B000	89430							

**Brockway School Bus**

Brockway school bus	Gabriel	Upgrade	Brockway school bus	Gabriel	Upgrade	Brockway school bus	Gabriel	Upgrade	Brockway school bus	Gabriel	Upgrade
14QK-281P10	85305		14QK282P1	83216		508657	85307		530873	89407	
14QK-282P1	83216		14QK282P3	83216		515231	85303	89422	532397	85307	
14QK-282P3	83216		152398	85304		515231	89422				
14QK281P10	85305		152412	83215		530873	83207	89407			

**Built Rite**

Built rite	Gabriel	Upgrade	Built rite	Gabriel	Upgrade	Built rite	Gabriel	Upgrade	Built rite	Gabriel	Upgrade
318-06-100	85006		70039	85303	89422	70041	85305				
31806100	85006		70039	89422							

**Bull Dog**

Bull dog	Gabriel	Upgrade	Bull dog	Gabriel	Upgrade	Bull dog	Gabriel	Upgrade	Bull dog	Gabriel	Upgrade
HD1113-0406	83400		HD1214-0507	646155		HD1214-0554	83048		HD1214-0605	85012	89413
HD1114-0257	83026		HD1214-0508	83203	89436	HD1214-0556	83136		HD1214-0605	89413	
HD1114-0258	83169		HD1214-0508	89436		HD1214-0557	83101		HD1214-0607	83154	
HD1116-0033	85311	89424	HD1214-0526	83613		HD1214-0558	83169		HD1214-0608	83303	
HD1116-0033	89424		HD1214-0528	83112		HD1214-0559	83309		HD1214-0609	85310	89423
HD1116-0034	85711		HD1214-0530	83123	89405	HD1214-0560	83141		HD1214-0609	89423	
HD1116-0036	85736		HD1214-0530	89405		HD1214-0561	85071		HD1214-0610	83027	
HD1116-0041	85300	89419	HD1214-0531	83130		HD1214-0562	83312	89409	HD1214-0611	83134	
HD1116-0041	89419		HD1214-0532	83125		HD1214-0562	89409		HD1214-0612	85033	89427
HD1116-0043	85303	89422	HD1214-0533	83124	89407	HD1214-0563	83215		HD1214-0612	89427	
HD1116-0043	89422		HD1214-0533	89407		HD1214-0564	83312	89409	HD1214-0613	83022	
HD1116-0044	85302	89420	HD1214-0534	83127		HD1214-0564	89409		HD1214-0614	83015	
HD1116-0044	89420		HD1214-0534	83207	89407	HD1214-0565	83110		HD1214-0636	83047	
HD1116-0045	85712		HD1214-0534	89407		HD1214-0566	83123	89405	HD1214-0637	83059	
HD1116-0046	85702		HD1214-0535	83009		HD1214-0566	89405		HD1214-0639	83004	
HD1116-0047	85304		HD1214-0536	83042		HD1214-0567	83215		HD1214-0640	83216	
HD1116-0048	85711		HD1214-0537	83051		HD1214-0568	83225		HD1214-0641	83216	
HD1116-0049	85729		HD1214-0538	83038		HD1214-0568	85007		HD1214-0642	83135	
HD1116-0050	85970		HD1214-0539	83126	89430	HD1214-0569	83035		HD1214-0644	83635	
HD1116-0051	85341		HD1214-0539	89430		HD1214-0570	89430		HD1214-0645	83119	
HD1116-0052	85727		HD1214-0540	83029		HD1214-0571	83159		HD1214-0655	83130	
HD1116-0059	85332		HD1214-0540	83515		HD1214-0572	83163		HD1214-0656	83103	
HD1213-0651	83021		HD1214-0541	83019		HD1214-0573	83025		HD1214-0657	83164	
HD1213-0652	83031		HD1214-0542	85052		HD1214-0574	83103		HD1214-0658	83308	
HD1213-0674	83401		HD1214-0544	83001		HD1214-0576	83029		HD1214-0660	83107	
HD1213-0679	83023		HD1214-0545	83456	89447	HD1214-0579	83221		HD1214-0661	83318	
HD1213-0680	83017		HD1214-0545	89447		HD1214-0580	83209	89414	HD1215-0018	85724	89443
HD1213-0705	85006		HD1214-0546	83008		HD1214-0580	89414		HD1215-0018	89443	
HD1213-0707	83034		HD1214-0550	83314		HD1214-0593	83120		HD1215-0020	85070	89459
HD1214-0496	83041		HD1214-0551	83126	89430	HD1214-0595	83308		HD1215-0020	89459	
HD1214-0497	83054		HD1214-0551	83207	89407	HD1214-0597	85066	89448			
HD1214-0499	85045		HD1214-0551	89407		HD1214-0597	89448				
HD1214-0500	83128	89436	HD1214-0551	89430		HD1214-0602	83120				
HD1214-0500	89436		HD1214-0553	83045		HD1214-0603	83150				

**Important Note:** Competitive Interchanges are to be used for stocking purposes only. Where multiple crosses are identified, please reference the applications section of this catalog. / **Remarque importante:** Les interchanges concurrentiels ne s'utilisent qu'aux fins de stocks. Dans le cas de rferences multiples, consulter la section des applications du catalogue. / **Nota importante:** Dans le cas de rferences multiples, consulter la section des applications du catalogue. / **Nota importante:** Se pueden usar intercambios competitivos para propósitos de almacenamiento solamente. Cuando se identifican intercambios múltiples, consulte la sección de aplicaciones de este catálogo.

**COMPETITIVE & O.E.M. INTERCHANGE LIST**  
**Lista de Intercambios contra Competidores y Equipo Original.**  
**Liste dinterchange de produits comptitifs & dquipement original (OEM)**

**Bull Dog... cont'd**

Bull dog	Gabriel	Upgrade	Bull dog	Gabriel	Upgrade	Bull dog	Gabriel	Upgrade	Bull dog	Gabriel	Upgrade
HD1215-0021	85901		HD1215-0043	85013	89414	HD1215-0076	85069	89455	HD1215-0109	85065	
HD1215-0022	85928		HD1215-0043	89414		HD1215-0076	89455		HD1215-0110	83122	89406
HD1215-0022	85957		HD1215-0044	85046	89434	HD1215-0077	85900		HD1215-0110	89406	
HD1215-0023	85031		HD1215-0044	89434		HD1215-0078	85036	89405	HD1215-0111	85043	
HD1215-0024	85918	89449	HD1215-0045	85013	89414	HD1215-0078	89405		HD1215-0113	85736	
HD1215-0024	85920	89503	HD1215-0045	89414		HD1215-0079	85919		HD1215-0114	85058	89431
HD1215-0024	89449		HD1215-0046	85045		HD1215-0080	85954		HD1215-0114	89431	
HD1215-0024	89503		HD1215-0046	85939		HD1215-0081	83136		HD1215-0115	85058	89431
HD1215-0025	85918	89449	HD1215-0047	85934		HD1215-0082	85311	89424	HD1215-0115	89431	
HD1215-0025	85958		HD1215-0048	85084	89460	HD1215-0082	89424		HD1215-0116	85058	89431
HD1215-0025	89449		HD1215-0048	85989		HD1215-0083	85978		HD1215-0116	89431	
HD1215-0026	85331		HD1215-0048	89460		HD1215-0084	83135		HD1215-0117	85910	
HD1215-0027	85924	89457	HD1215-0049	85047	89435	HD1215-0084	83163		HD1215-0118	83160	
HD1215-0027	89457		HD1215-0049	89435		HD1215-0085	85310	89423	HD1215-0119	85954	
HD1215-0028	85003	89411	HD1215-0051	85026		HD1215-0085	89423		HD1215-0122	85090	
HD1215-0028	89411		HD1215-0051	85081		HD1215-0086	85936	89456	HD1215-0123	83131	
HD1215-0029	85320	89429	HD1215-0052	85316	89426	HD1215-0086	89456		HD1215-0124	85024	
HD1215-0029	89429		HD1215-0052	89426		HD1215-0088	85006		HD1215-0125	85080	
HD1215-003	85033	89427	HD1215-0053	85933	89454	HD1215-0089	85303	89422	HD1215-0125	85081	
HD1215-003	89427		HD1215-0053	89454		HD1215-0089	89422		HD1215-0126	85376	
HD1215-0030	85066	89448	HD1215-0054	85909		HD1215-0090	85972		HD1215-0127	85082	
HD1215-0030	85088		HD1215-0055	85656		HD1215-0091	85321		HD1215-0128	85054	
HD1215-0030	89448		HD1215-0056	85012	89413	HD1215-0091	85916	89430	HD1215-0129	85967	
HD1215-0031	85069	89455	HD1215-0056	89413		HD1215-0091	89430		HD1215-0132	83143	
HD1215-0031	89455		HD1215-0058	85053	89442	HD1215-0092	85916	89430	HD1215-0133	83122	89406
HD1215-0032	85062	89408	HD1215-0058	89442		HD1215-0092	89430		HD1215-0133	89406	
HD1215-0032	89408		HD1215-0059	83123	89405	HD1215-0093	83209	89414	HD1215-0134	89402	
HD1215-0033	85311	89424	HD1215-0059	89405		HD1215-0093	89414		HD1215-0135	85040	
HD1215-0033	89424		HD1215-0060	85959		HD1215-0094	83142		HD1215-0136	85102	
HD1215-0034	85067	89451	HD1215-0061	85012	89413	HD1215-0095	83175		HD1215-0147	85927	
HD1215-0034	89451		HD1215-0061	89413		HD1215-0096	85029		HD1215-0148	85181	
HD1215-0036	85001	89410	HD1215-0062	85910		HD1215-0097	85300	89419	HD1215-0149	85700	
HD1215-0036	89410		HD1215-0063	83317		HD1215-0097	89419		HD1215-0150	85029	
HD1215-0038	85023	89415	HD1215-0064	85319	89428	HD1215-0100	85648		HD1215-0151	85010	
HD1215-0038	89415		HD1215-0064	89428		HD1215-0102	85938		HD1215-0152	83144	
HD1215-0039	85000	89436	HD1215-0065	85937		HD1215-0103	85932	89453	HD1215-0154	85995	
HD1215-0039	89436		HD1215-0066	85029		HD1215-0103	89453		HD1215-0156	83136	
HD1215-0040	83128	89436	HD1215-0067	83111		HD1215-0104	85956		HD1215-0157	85030	89440
HD1215-0040	89436		HD1215-0069	85072		HD1215-0106	85323	89436	HD1215-0157	89440	
HD1215-0041	85923	89458	HD1215-0071	85005	89430	HD1215-0106	85738		HD1215-0160	85125	
HD1215-0041	85931	89458	HD1215-0071	89430		HD1215-0106	89436		HD1215-0161	85929	
HD1215-0041	89458		HD1215-0072	85938		HD1215-0107	85001	89410	HD1215-0165	85338	
HD1215-0042	85014		HD1215-0073	85976		HD1215-0107	89410		HD1216-0005	87015	
HD1215-0042	85906	89407	HD1215-0074	85061	89450	HD1215-0108	85030	89440	HD1294-0002	632147	
HD1215-0042	89407		HD1215-0075	85052		HD1215-0108	89440		HD5115-0001	665937	

**Bus & Truck Co.**

Bus & truck co.	Gabriel	Upgrade	Bus & truck co.	Gabriel	Upgrade	Bus & truck co.	Gabriel	Upgrade	Bus & truck co.	Gabriel	Upgrade
680091	85303	89422	70039	85303	89422	70041	85305				
680091	89422		70039	89422							

**CargoMaxx**

Cargomaxx	Gabriel	Upgrade	Cargomaxx	Gabriel	Upgrade	Cargomaxx	Gabriel	Upgrade	Cargomaxx	Gabriel	Upgrade
441 - 646155	646155		441 - 83031	83031		441 - 83110	83110		441 - 83123	89405	
441 - 83001	83001		441 - 83038	83038		441 - 83111	83111		441 - 83124	83124	89407
441 - 83008	83008		441 - 83041	83041		441 - 83112	83112				
441 - 83009	83009		441 - 83042	83042		441 - 83122	83122	89406			
441 - 83021	83021		441 - 83048	83048		441 - 83122	89406				
441 - 83025	83025		441 - 83051	83051		441 - 83123	83123	89405			

**Important Note:** Competitive Interchanges are to be used for stocking purposes only. Where multiple crosses are identified, please reference the applications section of this catalog. / **Remarque importante:** Les interchanges concurrentiels ne s'utilisent qu'aux fins de stocks. Dans le cas de rfrences multiples, consulter la section des applications du catalogue. / **Nota importante:** Dans le cas de rfrences multiples, consultar la section des aplicaciones du catalogue. / **Nota importante:** Se pueden usar intercambios competitivos para propósitos de almacenamiento solamente. Cuando se identifican intercambios múltiples, consulte la sección de aplicaciones de este catálogo.

**COMPETITIVE & O.E.M. INTERCHANGE LIST**  
**Lista de Intercambios contra Competidores y Equipo Original.**  
**Liste dinterchange de produits comptitifs & dquipement original (OEM)**

**CargoMaxx... cont'd**

Cargomaxx	Gabriel	Upgrade	Cargomaxx	Gabriel	Upgrade	Cargomaxx	Gabriel	Upgrade	Cargomaxx	Gabriel	Upgrade
441 - 83124	89407		441 - 85005	89430		441 - 85067	89451		441 - 85906	85906	89407
441 - 83125	83125		441 - 850065482	85006		441 - 850695468	85069	89455	441 - 85906	89407	
441 - 831266833	83126	89430	441 - 850065505	85006		441 - 850695468	89455		441 - 85909	85909	
441 - 831266833	89430		441 - 85012	85012	89413	441 - 850695528	85069	89455	441 - 85910	85910	
441 - 831266897	83126	89430	441 - 85012	89413		441 - 850695528	89455		441 - 859185140	85918	89449
441 - 831266897	89430		441 - 850125113	85012	89413	441 - 85070	85070	89459	441 - 859185140	89449	
441 - 831266969	83126	89430	441 - 850125113	89413		441 - 85070	89459		441 - 859185148	85918	89449
441 - 831266969	89430		441 - 850135401	85013	89414	441 - 85072	85072		441 - 859185148	89449	
441 - 83127	83127		441 - 850135401	89414		441 - 85084	85084	89460	441 - 85919	85919	
441 - 83128	83128	89436	441 - 850135420	85013	89414	441 - 85084	89460		441 - 85924	85924	89457
441 - 83128	89436		441 - 850135420	89414		441 - 85090	85090		441 - 85924	89457	
441 - 83130	83130		441 - 85023	85023	89415	441 - 85119	85119		441 - 85925	85648	
441 - 83136	83136		441 - 85023	89415		441 - 85300	85300	89419	441 - 85926	85656	
441 - 83142	83142		441 - 85024	85024		441 - 85300	89419		441 - 85931	85931	89458
441 - 83143	83143		441 - 85026	85026		441 - 853006861	85300	89419	441 - 85931	89458	
441 - 83156	83169		441 - 85029	85029		441 - 853006861	89419		441 - 85932	85932	89453
441 - 831635143	83163		441 - 850295451	85029		441 - 85302	85302	89420	441 - 85932	89453	
441 - 831636422	83163		441 - 85030	85030	89440	441 - 85302	89420		441 - 85933	85933	89454
441 - 832036634	83203	89436	441 - 85030	89440		441 - 85303	85303	89422	441 - 85933	89454	
441 - 832036634	89436		441 - 85031	85031		441 - 85303	89422		441 - 85934	85934	
441 - 832036893	83203	89436	441 - 85033	85033	89427	441 - 85310	85310	89423	441 - 85936	85936	89456
441 - 832036893	89436		441 - 85033	89427		441 - 85310	89423		441 - 85936	89456	
441 - 83209	83209	89414	441 - 850365411	85036	89405	441 - 853104409	85310	89423	441 - 85937	85937	
441 - 83209	89414		441 - 850365411	89405		441 - 853104409	89423		441 - 85938	85938	
441 - 83215	83215		441 - 850365481	85036	89405	441 - 853114417	85311	89424	441 - 85939	85939	
441 - 83221	83221		441 - 850365481	89405		441 - 853114417	89424		441 - 85954	85954	
441 - 83309	83309		441 - 85045	85045		441 - 853115402	85311	89424	441 - 85956	85956	
441 - 833126668	83312	89409	441 - 85046	85046	89434	441 - 853115402	89424		441 - 85957	85957	
441 - 833126668	89409		441 - 85046	89434		441 - 853115444	85311	89424	441 - 85959	85959	
441 - 833126811	83312	89409	441 - 85047	85047	89435	441 - 853115444	89424		441 - 85972	85972	
441 - 833126811	89409		441 - 85047	89435		441 - 85316	85316	89426	441 - 85976	85976	
441 - 83317	83317		441 - 850525510	85052		441 - 85316	89426		441 - 85978	85978	
441 - 83456	83456	89447	441 - 850526607	85052		441 - 85319	85319	89428	441 - 87015	87015	
441 - 83456	89447		441 - 85053	85053	89442	441 - 85319	89428		441-65514	89405	
441 - 83515	83515		441 - 85053	89442		441 - 85320	85320	89429	441-83124	83124	89407
441 - 83613	83613		441 - 850585109	85058	89431	441 - 85320	89429		441-85045	85045	
441 - 850005416	85000	89436	441 - 850585109	89431		441 - 85321	85321		441-85046	85046	89434
441 - 850005416	89436		441 - 850585478	85058	89431	441 - 85323	85323	89436	441-85061	89450	
441 - 850005419	85000	89436	441 - 850585478	89431		441 - 85323	89436		441-853114417	85311	89424
441 - 850005419	89436		441 - 85061	85061	89450	441 - 85724	85724	89443	441-853115402	85311	89424
441 - 85001	85001	89410	441 - 85062	85062	89408	441 - 85724	89443		441-853115444	85311	89424
441 - 85001	89410		441 - 85062	89408		441 - 85736	85736		441-85323	85323	89436
441 - 85003	85003	89411	441 - 85066	85066	89448	441 - 85738	85738		441-85933	89454	
441 - 85003	89411		441 - 85066	89448		441 - 85900	85900		441-85959	85959	
441 - 85005	85005	89430	441 - 85067	85067	89451	441 - 85901	85901				

**Carpenter Bus**

Carpenter bus	Gabriel	Upgrade	Carpenter bus	Gabriel	Upgrade	Carpenter bus	Gabriel	Upgrade	Carpenter bus	Gabriel	Upgrade
0272-SS5	85712		0272SS5	85712		63-0001	85713		630001	85713	

**Cascade Trailer**

Cascade trailer	Gabriel	Upgrade	Cascade trailer	Gabriel	Upgrade	Cascade trailer	Gabriel	Upgrade	Cascade trailer	Gabriel	Upgrade
120-1	83125		1201	83125							

**Caterpillar**

Caterpillar	Gabriel	Upgrade	Caterpillar	Gabriel	Upgrade	Caterpillar	Gabriel	Upgrade	Caterpillar	Gabriel	Upgrade
060665-011	85967		60657003L	85072		60670-005	83137				
60657-003	85072		60665-011	85967		60670-005L	83137				
60657-003L	85072		60665-011L	85967		60670005	83137				
60657003	85072		60665011	85967		60670005L	83137				

**Important Note:** Competitive Interchanges are to be used for stocking purposes only. Where multiple crosses are identified, please reference the applications section of this catalog. / **Remarque importante:** Les interchanges concurrentiels ne s'utilisent qu'aux fins de stocks. Dans le cas de rferences multiples, consulter la section des applications du catalogue. / **Nota importante:** Dans le cas de rferences multiples, consulter la section des applications du catalogue. / **Nota importante:** Se pueden usar intercambios competitivos para propósitos de almacenamiento solamente. Cuando se identifican intercambios múltiples, consulte la sección de aplicaciones de este catálogo.



**COMPETITIVE & O.E.M. INTERCHANGE LIST**  
**Lista de Intercambios contra Competidores y Equipo Original.**  
**Liste dinterchange de produits comptitifs & dquipement original (OEM)**

**Caterpillar... cont'd**

Caterpillar	Gabriel	Upgrade	Caterpillar	Gabriel	Upgrade	Caterpillar	Gabriel	Upgrade	Caterpillar	Gabriel	Upgrade
60680-004	83143		60680-005L	83142		60680005	83142		HDR60680-005	83142	
60680-004L	83143		60680004	83143		60680005L	83142		HDR60680005	83142	
60680-005	83142		60680004L	83143		H60680004	83143				

**Challenge Cook**

Challenge cook	Gabriel	Upgrade	Challenge cook	Gabriel	Upgrade	Challenge cook	Gabriel	Upgrade	Challenge cook	Gabriel	Upgrade
1540212	646155		1540459	646155		632147	632147		632155	646177	

**Chalmers Suspension**

Chalmers suspension	Gabriel	Upgrade	Chalmers suspension	Gabriel	Upgrade	Chalmers suspension	Gabriel	Upgrade	Chalmers suspension	Gabriel	Upgrade
21335	G63355		800781	85314	89425	K880233	85060		K880248	89425	
665174	85060		800781	89425		K880247	85060		K880642	85060	
800670	85060		K800199	85060		K880248	85314	89425			

**Champion Bus Inc.**

Champion bus inc.	Gabriel	Upgrade	Champion bus inc.	Gabriel	Upgrade	Champion bus inc.	Gabriel	Upgrade	Champion bus inc.	Gabriel	Upgrade
22064230	83136		8C2Z-18124-D	G63622		ASH-1154	G63622		AT163G	G63622	
8C24-18045-DA	G63622		8C2Z-18125-D	G63623		ASH1136	G63623		AT164G	G63623	
8C24-18080-DB	G63623		8C2Z18124D	G63622		ASH1154	G63622				
8C2418045DA	G63622		8C2Z18125D	G63623		AT-163G	G63622				
8C2418080DB	G63623		ASH-1136	G63623		AT-164G	G63623				

**Chance Coach**

Chance coach	Gabriel	Upgrade	Chance coach	Gabriel	Upgrade	Chance coach	Gabriel	Upgrade	Chance coach	Gabriel	Upgrade
2021459	85012	89413	59039	83207	89407	6892	89407		728600	89436	
2021459	89413		59039	89407		6893	83203	89436	AS789B	85014	
270-6708	85014		665017	85014		6893	89436				
2706708	85014		6892	83207	89407	728600	83203	89436			

**Clark Equipment**

Clark equipment	Gabriel	Upgrade	Clark equipment	Gabriel	Upgrade	Clark equipment	Gabriel	Upgrade	Clark equipment	Gabriel	Upgrade
355778	85315		5532675	85307		680042	85301				

**CLV Warehouse INC**

Civ warehouse inc	Gabriel	Upgrade	Civ warehouse inc	Gabriel	Upgrade	Civ warehouse inc	Gabriel	Upgrade	Civ warehouse inc	Gabriel	Upgrade
MON-65103	85320	89429	MON-65419	85000	89436	MON-65468	85069	89455	MON-66893	83203	89436
MON-65175	85084	89460	MON-65458	85908		MON-65495	85067	89451			

**CNH Global NV.**

Cnh global nv.	Gabriel	Upgrade	Cnh global nv.	Gabriel	Upgrade	Cnh global nv.	Gabriel	Upgrade	Cnh global nv.	Gabriel	Upgrade
87019546	83022		87268250	83021							

**Coachmen**

Coachmen	Gabriel	Upgrade	Coachmen	Gabriel	Upgrade	Coachmen	Gabriel	Upgrade	Coachmen	Gabriel	Upgrade
141700131809	85029		48170000493	85900		9U9Z-18124-A	83209	89414	ASH-1229	89414	
141700131810	83160		66153-002	83124	89407	9U9Z-18124-A	89414		ASH-1230	83122	89406
16-16736-000	85029		66153-002	89407		9U9Z-18125-A	83122	89406	ASH-1230	89406	
16-16737-000	83160		66153002	83124	89407	9U9Z-18125-A	89406		ASH-137	83122	89406
16-16873-000	85029		66153002	89407		9U9Z18124A	83209	89414	ASH-137	89406	
16-16874-000	83160		8C24-18045-DA	G63622		9U9Z18124A	89414		ASH-25822	83209	89414
16-18103-000	85900		8C24-18080-DB	G63623		9U9Z18125A	83122	89406	ASH-25822	89414	
1616736000	85029		8C2418045DA	G63622		9U9Z18125A	89406		ASH-25823	83209	89414
1616737000	83160		8C2418080DB	G63623		ASH-1022	83209	89414	ASH-25823	89414	
1616873000	85029		8C2Z-18124-D	G63622		ASH-1022	89414		ASH-25824	83122	89406
1616874000	83160		8C2Z-18125-D	G63623		ASH-1023	83122	89406	ASH-25824	89406	
1618103000	85900		8C2Z18124D	G63622		ASH-1023	89406		ASH-294	83209	89414
1C34-18045-AA	83209	89414	8C2Z18125D	G63623		ASH-1136	G63623		ASH-294	89414	
1C34-18045-AA	89414		9U94-18045-AA	83209	89414	ASH-1154	G63622		ASH1022	83209	89414
1C34-18045-JA	83209	89414	9U94-18045-AA	89414		ASH-1205	83209	89414	ASH1022	89414	
1C34-18045-JA	89414		9U94-18080-AA	83122	89406	ASH-1205	89414		ASH1023	83122	89406
1C3418045AA	83209	89414	9U94-18080-AA	89406		ASH-1206	83122	89406	ASH1023	89406	
1C3418045AA	89414		9U9418045AA	83209	89414	ASH-1206	89406				
1C3418045JA	83209	89414	9U9418045AA	89414		ASH-1228	83209	89414			
1C3418045JA	89414		9U9418080AA	83122	89406	ASH-1228	89414				
48170000490	85900		9U9418080AA	89406		ASH-1229	83209	89414			

**Important Note:** Competitive Interchanges are to be used for stocking purposes only. Where multiple crosses are identified, please reference the applications section of this catalog. / **Remarque importante:** Les interchanges concurrentiels ne s'utilisent qu'aux fins de stocks. Dans le cas de rferences multiples, consulter la section des applications du catalogue. / **Nota importante:** En el caso de rferences multiples, consultar la seccion de aplicaciones del catalogo. / **Nota importante:** Se pueden usar intercambios competitivos para propósitos de almacenamiento solamente. Cuando se identifican intercambios múltiples, consulte la seccion de aplicaciones de este catalogo.

**COMPETITIVE & O.E.M. INTERCHANGE LIST**  
**Lista de Intercambios contra Competidores y Equipo Original.**  
**Liste dinterchange de produits comptitifs & dquipement original (OEM)**

**Coachmen... cont'd**

Coachmen	Gabriel	Upgrade	Coachmen	Gabriel	Upgrade	Coachmen	Gabriel	Upgrade	Coachmen	Gabriel	Upgrade
ASH1136	G63623		ASH1230	89406		AT-163G	G63622		AT620	89414	
ASH1154	G63622		ASH137	83122	89406	AT-164G	G63623		AT621	83122	89406
ASH1205	83209	89414	ASH137	89406		AT-620	83209	89414	AT621	89406	
ASH1205	89414		ASH25822	83209	89414	AT-620	89414		AT766	83209	89414
ASH1206	83122	89406	ASH25822	89414		AT-621	83122	89406	AT766	89414	
ASH1206	89406		ASH25823	83209	89414	AT-621	89406		F4-BE5-C832-MO	83124	89407
ASH1228	83209	89414	ASH25823	89414		AT-766	83209	89414	F4-BE5-C832-MO	89407	
ASH1228	89414		ASH25824	83122	89406	AT-766	89414		F4BE5C832MO	83124	89407
ASH1229	83209	89414	ASH25824	89406		AT163G	G63622		F4BE5C832MO	89407	
ASH1229	89414		ASH294	83209	89414	AT164G	G63623				
ASH1230	83122	89406	ASH294	89414		AT620	83209	89414			

**Cofap**

Cofap	Gabriel	Upgrade	Cofap	Gabriel	Upgrade	Cofap	Gabriel	Upgrade	Cofap	Gabriel	Upgrade
45011	85702		45117	85918	89449	ATG-051	G63426		L-12687	83030	
45054	85301		45117	89449		ATG-084	G63608		L-12703	85071	
45056	85315		45139C-Y	85901		ATG-085	G63607		L-12713	83136	
45058	85301		8482	85026		L-12039	85065				

**Condumex**

Condumex	Gabriel	Upgrade	Condumex	Gabriel	Upgrade	Condumex	Gabriel	Upgrade	Condumex	Gabriel	Upgrade
43066	83309		58050	89450		69711	89407		69752	89426	
43139	83021		58055	85003	89411	69712	85013	89414	69753	85031	
43145	83021		58055	89411		69712	89414		78001	85314	89425
53010	83136		58056	83137		69713	85046	89434	78001	89425	
53018	83317		58057	83456	89447	69713	89434		78002	85702	
53019	83456	89447	58057	89447		69716	85024		78003	85308	89422
53019	89447		58058	85031		69717	85310	89423	78003	89422	
53039	85006		58059	85005	89430	69717	89423		78005	85310	89423
53040	85006		58059	89430		69720	85736		78005	89423	
53041	85310	89423	58061	83122	89406	69726	85319	89428	78007	85307	
53041	89423		58061	85916	89430	69726	89428		78009	85303	89422
53042	83309		58061	89406		69728	85055	89439	78009	89422	
53043	83215		58061	89430		69728	89439		78013	85323	89436
53059	85051		69500	83122	89406	69729	85314	89425	78013	89436	
53063	83025		69500	89406		69729	89425		78015	85724	89443
53065	83136		69515	83124	89407	69732	85300	89419	78015	89443	
53066	83124	89407	69515	89407		69732	89419		78016	85001	89410
53066	89407		69669	83123	89405	69741	85906	89407	78016	89410	
58012	85314	89425	69669	89405		69741	89407		78020	85712	
58012	89425		69670	85051		69743	85061	89450	78023	85705	89447
58034	85013	89414	69671	85006		69743	89450		78023	89447	
58034	89414		69672	85043		69745	85058	89431	78025	85009	
58038	85001	89410	69673	83209	89414	69745	89431		78027	85314	89425
58038	89410		69673	89414		69746	83137		78027	89425	
58040	85026		69680	89402		69747	85003	89411	78030	85316	89426
58041	83456	89447	69685	83136		69747	89411		78030	89426	
58041	89447		69688	85302	89420	69748	85001	89410	78034	85920	89503
58048	83137		69688	89420		69748	89410		78034	89503	
58049	85323	89436	69705	83122	89406	69750	85314	89425	78039	85311	89424
58049	89436		69705	89406		69750	89425		78039	89424	
58050	85061	89450	69711	83207	89407	69752	85316	89426			

**Continental**

Continental	Gabriel	Upgrade	Continental	Gabriel	Upgrade	Continental	Gabriel	Upgrade	Continental	Gabriel	Upgrade
38478	85307										

**Continental Trailways-Eagle Intl.**

Continental trailways-eagle intl.	Gabriel	Upgrade	Continental trailways-eagle intl.	Gabriel	Upgrade	Continental trailways-eagle intl.	Gabriel	Upgrade	Continental trailways-eagle intl.	Gabriel	Upgrade
01-0100-020	85307		01-0100-905	89422							
01-0100-905	85303	89422	010100020	85307							

**Important Note:** Competitive Interchanges are to be used for stocking purposes only. Where multiple crosses are identified, please reference the applications section of this catalog. / **Remarque importante:** Les interchanges concurrentiels ne s'utilisent qu'aux fins de stocks. Dans le cas de rferences multiples, consulter la section des applications du catalogue. / **Nota importante:** Dans le cas de rferences multiples, consulter la section des applications du catalogue. / **Nota importante:** Se pueden usar intercambios competitivos para propósitos de almacenamiento solamente. Cuando se identifican intercambios múltiples, consulte la sección de aplicaciones de este catálogo.

**COMPETITIVE & O.E.M. INTERCHANGE LIST**  
**Lista de Intercambios contra Competidores y Equipo Original.**  
**Liste dinterchange de produits comptitifs & dquipement original (OEM)**

**Continental Trailways-Eagle Intl... cont'd**

Continental trailways-eagle intl.	Gabriel	Upgrade	Continental trailways-eagle intl.	Gabriel	Upgrade	Continental trailways-eagle intl.	Gabriel	Upgrade	Continental trailways-eagle intl.	Gabriel	Upgrade
010100905	85303	89422	5532026	85304		680091	85303	89422	70039	89422	
010100905	89422		6-05-5	85307		680091	89422		70041	85305	
5394467	85305		6055	85307		70039	85303	89422			

**Country Coach**

Country coach	Gabriel	Upgrade	Country coach	Gabriel	Upgrade	Country coach	Gabriel	Upgrade	Country coach	Gabriel	Upgrade
10-13634-000	85918	89449	16-18708-000	89443		8C24-18045-DA	G63622		ASH-1154	G63622	
10-13634-000	89449		1618708000	85724	89443	8C24-18080-DB	G63623		ASH1136	G63623	
10-13760-000	85959		1618708000	89443		8C2418045DA	G63622		ASH1154	G63622	
10-13809-000	85958		471700000449	85918	89449	8C2418080DB	G63623		AT-163G	G63622	
1013634000	85918	89449	471700000449	89449		8C2Z-18124-D	G63622		AT-164G	G63623	
1013634000	89449		471700002809	85724	89443	8C2Z-18125-D	G63623		AT163G	G63622	
1013760000	85959		471700002809	89443		8C2Z18124D	G63622		AT164G	G63623	
1013809000	85958		471700002991	85959		8C2Z18125D	G63623		SDA471700002991	85959	
16-18708-000	85724	89443	471700003920	85958		ASH-1136	G63623				

**Crane Carrier**

Crane carrier	Gabriel	Upgrade	Crane carrier	Gabriel	Upgrade	Crane carrier	Gabriel	Upgrade	Crane carrier	Gabriel	Upgrade
1265157B000	85712		277A-14	85304		277A14	85304		64178-001	83143	
1310002	665937		277A-8	85303	89422	277A8	85303	89422	64178001	83143	
227A-14	85716		277A-8	89422		277A8	89422		680088	85713	
227A14	85716		277A-9	85307		277A9	85307		680091	85303	89422
277A-1	85307		277A1	85307		60680-004	83143		680091	89422	
277A-12	85304		277A12	85304		60680-004L	83143				
277A-13	85302	89420	277A13	85302	89420	60680004	83143				
277A-13	89420		277A13	89420		60680004L	83143				

**Crown Coach**

Crown coach	Gabriel	Upgrade	Crown coach	Gabriel	Upgrade	Crown coach	Gabriel	Upgrade	Crown coach	Gabriel	Upgrade
3188729	85303	89422	3188729	89422		5532026	85304		5532036	85734	

**Cunha Products OHD**

Cunha products ohd	Gabriel	Upgrade	Cunha products ohd	Gabriel	Upgrade	Cunha products ohd	Gabriel	Upgrade	Cunha products ohd	Gabriel	Upgrade
CP-5222	85315		CP5222	85315							

**Cush Corporation**

Cush corporation	Gabriel	Upgrade	Cush corporation	Gabriel	Upgrade	Cush corporation	Gabriel	Upgrade	Cush corporation	Gabriel	Upgrade
C0062-D	85000	89436	C0062D	89436		C0226	85064		C0228	89430	
C0062-D	89436		C0078	85000	89436	C0227	85014		C04045	85045	
C0062D	85000	89436	C0078	89436		C0228	85005	89430			

**Damon Motor Coach**

Damon motor coach	Gabriel	Upgrade	Damon motor coach	Gabriel	Upgrade	Damon motor coach	Gabriel	Upgrade	Damon motor coach	Gabriel	Upgrade
1C34-18045-AA	83209	89414	9U9418045AA	89414		ASH-1228	83209	89414	ASH1023	89406	
1C34-18045-AA	89414		9U9418080AA	83122	89406	ASH-1228	89414		ASH1205	83209	89414
1C34-18045-JA	83209	89414	9U9418080AA	89406		ASH-1229	83209	89414	ASH1205	89414	
1C34-18045-JA	89414		9U9Z-18124-A	83209	89414	ASH-1229	89414		ASH1206	83122	89406
1C3418045AA	83209	89414	9U9Z-18124-A	89414		ASH-1230	83122	89406	ASH1206	89406	
1C3418045AA	89414		9U9Z-18125-A	83122	89406	ASH-1230	89406		ASH1228	83209	89414
1C3418045JA	83209	89414	9U9Z-18125-A	89406		ASH-137	83122	89406	ASH1228	89414	
1C3418045JA	89414		9U9Z18124A	83209	89414	ASH-137	89406		ASH1229	83209	89414
24-153249	85125		9U9Z18124A	89414		ASH-25822	83209	89414	ASH1229	89414	
24-153256	85124		9U9Z18125A	83122	89406	ASH-25822	89414		ASH1230	83122	89406
24-186629	85125		9U9Z18125A	89406		ASH-25823	83209	89414	ASH1230	89406	
24153249	85125		ASH-1022	83209	89414	ASH-25823	89414		ASH137	83122	89406
24153256	85124		ASH-1022	89414		ASH-25824	83122	89406	ASH137	89406	
24186629	85125		ASH-1023	83122	89406	ASH-25824	89406		ASH25822	83209	89414
9U94-18045-AA	83209	89414	ASH-1023	89406		ASH-294	83209	89414	ASH25822	89414	
9U94-18045-AA	89414		ASH-1205	83209	89414	ASH-294	89414		ASH25823	83209	89414
9U94-18080-AA	83122	89406	ASH-1205	89414		ASH1022	83209	89414	ASH25823	89414	
9U94-18080-AA	89406		ASH-1206	83122	89406	ASH1022	89414		ASH25824	83122	89406
9U9418045AA	83209	89414	ASH-1206	89406		ASH1023	83122	89406	ASH25824	89406	

**Important Note:** Competitive Interchanges are to be used for stocking purposes only. Where multiple crosses are identified, please reference the applications section of this catalog. / **Remarque importante:** Les interchanges concurrentiels ne s'utilisent qu'aux fins de stocks. Dans le cas de rfrences multiples, consulter la section des applications du catalogue. / **Nota importante:** Dans le cas de rfrences multiples, consultar la section des aplicaciones du catalogue. / **Nota importante:** Se pueden usar intercambios competitivos para propósitos de almacenamiento solamente. Cuando se identifican intercambios múltiples, consulte la sección de aplicaciones de este catálogo.

# COMPETITIVE & O.E.M. INTERCHANGE LIST

## Lista de Intercambios contra Competidores y Equipo Original.

### Liste d'interchange de produits compétitifs & d'équipement original (OEM)

#### Damon Motor Coach... cont'd

Damon motor coach	Gabriel	Upgrade	Damon motor coach	Gabriel	Upgrade	Damon motor coach	Gabriel	Upgrade	Damon motor coach	Gabriel	Upgrade
ASH294	83209	89414	AT-766	89414		F4-BE5-A832-MO	85125		F4BE5F325HO	85124	
ASH294	89414		AT620	83209	89414	F4-BE5-B492-HO	85125		W0005662	85125	
AT-620	83209	89414	AT620	89414		F4-BE5-F324-HO	85125		W0005663	85124	
AT-620	89414		AT621	83122	89406	F4-BE5-F325-HO	85124		W0006254	85125	
AT-621	83122	89406	AT621	89406		F4BE5A832MO	85125				
AT-621	89406		AT766	83209	89414	F4BE5B492HO	85125				
AT-766	83209	89414	AT766	89414		F4BE5F324HO	85125				

#### Dana

Dana	Gabriel	Upgrade	Dana	Gabriel	Upgrade	Dana	Gabriel	Upgrade	Dana	Gabriel	Upgrade
SR1VJ100	85078										

#### Dayton parts

Dayton parts	Gabriel	Upgrade	Dayton parts	Gabriel	Upgrade	Dayton parts	Gabriel	Upgrade	Dayton parts	Gabriel	Upgrade
M65419	85000	89436	M65512	85938		M66502	646177		M66893	83203	89436

#### Dexter Axle

Dexter axle	Gabriel	Upgrade	Dexter axle	Gabriel	Upgrade	Dexter axle	Gabriel	Upgrade	Dexter axle	Gabriel	Upgrade
18165-01	85006		1816501	85006							

#### Diamond T

Diamond t	Gabriel	Upgrade	Diamond t	Gabriel	Upgrade	Diamond t	Gabriel	Upgrade	Diamond t	Gabriel	Upgrade
5549925	85304										

#### Diamond-Reo

Diamond-reo	Gabriel	Upgrade	Diamond-reo	Gabriel	Upgrade	Diamond-reo	Gabriel	Upgrade	Diamond-reo	Gabriel	Upgrade
220-55-1	83214		220-55-7	85304		220552	85304		220S510	85712	
220-55-2	85304		220-S5-10	85712		220556	83214				
220-55-6	83214		220551	83214		220557	85304				

#### Dina Bus

Dina bus	Gabriel	Upgrade	Dina bus	Gabriel	Upgrade	Dina bus	Gabriel	Upgrade	Dina bus	Gabriel	Upgrade
13424S	83317		152C030010	83317		39380353-6	85716		39390340-4	85716	
1520030010	83317		152E030030	85014		39390339-6	85307				

#### Duplex Truck

Duplex truck	Gabriel	Upgrade	Duplex truck	Gabriel	Upgrade	Duplex truck	Gabriel	Upgrade	Duplex truck	Gabriel	Upgrade
59024	83204		7604-3371	83204		76043371	83204				

#### Dura Suspension

Dura suspension	Gabriel	Upgrade	Dura suspension	Gabriel	Upgrade	Dura suspension	Gabriel	Upgrade	Dura suspension	Gabriel	Upgrade
1080099	83203	89436	59024	83204		665133	89436		A-2212	85029	
1080099	89436		59030	83203	89436	665267	85029		A2212	85029	
12866	83207	89407	59030	89436		7604-3371	83204				
12866	89407		665133	83203	89436	76043371	83204				

#### Dynamax Corp.

Dynamax corp.	Gabriel	Upgrade	Dynamax corp.	Gabriel	Upgrade	Dynamax corp.	Gabriel	Upgrade	Dynamax corp.	Gabriel	Upgrade
10-12390-000	85920	89503	1013063000	85918	89449	471700000449	85918	89449	8C24-18045-DA	G63622	
10-12390-000	89503		1013063000	89449		471700000449	89449		8C24-18080-DB	G63623	
10-13021-000	85918	89449	1013211000	85918	89449	471700000450	85918	89449	8C2418045DA	G63622	
10-13021-000	89449		1013211000	89449		471700000450	89449		8C2418080DB	G63623	
10-13063-000	85918	89449	1013634000	85918	89449	471700002808	85724	89443	8C2Z-18124-D	G63622	
10-13063-000	89449		1013634000	89449		471700002808	89443		8C2Z-18125-D	G63623	
10-13211-000	85918	89449	1013684000	85918	89449	471700002809	85724	89443	8C2Z18124D	G63622	
10-13211-000	89449		1013684000	89449		471700002809	89443		8C2Z18125D	G63623	
10-13634-000	85918	89449	1013760000	85959		471700002810	85724	89443	ASH-1136	G63623	
10-13634-000	89449		1013809000	85958		471700002810	89443		ASH-1154	G63622	
10-13684-000	85918	89449	16-15817-000	85724	89443	471700002991	85959		ASH1136	G63623	
10-13684-000	89449		16-15817-000	89443		471700003920	85958		ASH1154	G63622	
10-13760-000	85959		16-18708-000	85724	89443	471700131155	85918	89449	AT-163G	G63622	
10-13809-000	85958		16-18708-000	89443		471700131155	89449		AT-164G	G63623	
1012390000	85920	89503	1615817000	85724	89443	481700006848	85724	89443			
1012390000	89503		1615817000	89443		481700006848	89443				
1013021000	85918	89449	1618708000	85724	89443	680611	85724	89443			
1013021000	89449		1618708000	89443		680611	89443				

**Important Note:** Competitive Interchanges are to be used for stocking purposes only. Where multiple crosses are identified, please reference the applications section of this catalog. / **Remarque importante:** Les interchanges concurrentiels ne s'utilisent qu'aux fins de stocks. Dans le cas de références multiples, consulter la section des applications du catalogue. / **Nota importante:** Dans le cas de références multiples, consulter la section des applications du catalogue. / **Nota importante:** Se pueden usar intercambios competitivos para propósitos de almacenamiento solamente. Cuando se identifican intercambios múltiples, consulte la sección de aplicaciones de este catálogo.

**COMPETITIVE & O.E.M. INTERCHANGE LIST**  
**Lista de Intercambios contra Competidores y Equipo Original.**  
**Liste dinterchange de produits compititifs & dquipement original (OEM)**

**Dynamax Corp.... cont'd**

Dynamax corp.	Gabriel	Upgrade	Dynamax corp.	Gabriel	Upgrade	Dynamax corp.	Gabriel	Upgrade	Dynamax corp.	Gabriel	Upgrade
AT163G	G63622		SDA471700002809	85724	89443	SDA471700002991	85959				
AT164G	G63623		SDA471700002809	89443		SDA471700003920	85958				

**E-One**

E-one	Gabriel	Upgrade	E-one	Gabriel	Upgrade	E-one	Gabriel	Upgrade	E-one	Gabriel	Upgrade
90-2572	85329		ASH-1154	G63622		ASH1154	G63622				
ASH-1136	G63623		ASH1136	G63623							

**Eagle Motor Coach**

Eagle motor coach	Gabriel	Upgrade	Eagle motor coach	Gabriel	Upgrade	Eagle motor coach	Gabriel	Upgrade	Eagle motor coach	Gabriel	Upgrade
01-0100-020	85307		0140100-905	85308	89422	154-0100-514	89425		680091	85303	89422
01-0100-905	85303	89422	0140100-905	89422		1540100514	85314	89425	680091	89422	
01-0100-905	89422		0140100905	85308	89422	1540100514	89425		690060	85713	
010100020	85307		0140100905	89422		38478	85307		70039	85303	89422
010100905	85303	89422	101364	85305		5394467	85305		70039	89422	
010100905	89422		12J-5-10	85733		5532026	85304		70041	85305	
014-0100-905	85308	89422	12J510	85733		6-05-5	85307				
014-0100-905	89422		154-0100-514	85314	89425	6055	85307				

**East Manufacturing Corp.**

East manufacturing corp.	Gabriel	Upgrade	East manufacturing corp.	Gabriel	Upgrade	East manufacturing corp.	Gabriel	Upgrade	East manufacturing corp.	Gabriel	Upgrade
517-05001-18	87015		517-05805-20	85000	89436	5170500620	89440		5170591614	83124	89407
517-05001-23	85005	89430	517-05805-20	89436		5170500914	83125		5170591614	89407	
517-05001-23	89430		517-05806-20	85029		5170501007	83214		A-20002	85000	89436
517-05006-20	85030	89440	517-05808-20	85738		5170511020	85000	89436	A-20002	89436	
517-05006-20	89440		517-05809-20	89437		5170511020	89436		A-20126	85323	89436
517-05009-14	83125		517-05916-14	83124	89407	5170551114	83128	89436	A-20126	89436	
517-05010-07	83214		517-05916-14	89407		5170551114	89436		A20002	85000	89436
517-05110-20	85000	89436	5170500118	87015		5170580520	85000	89436	A20002	89436	
517-05110-20	89436		5170500123	85005	89430	5170580520	89436		A20126	85323	89436
517-05511-14	83128	89436	5170500123	89430		5170580620	85029		A20126	89436	
517-05511-14	89436		5170500620	85030	89440	5170580820	85738				

**Eaton**

Eaton	Gabriel	Upgrade	Eaton	Gabriel	Upgrade	Eaton	Gabriel	Upgrade	Eaton	Gabriel	Upgrade
GAB85995	85995		SAC315389	85090							

**Emergency One**

Emergency one	Gabriel	Upgrade	Emergency one	Gabriel	Upgrade	Emergency one	Gabriel	Upgrade	Emergency one	Gabriel	Upgrade
90-2572	85329										

**Entegra Coach**

Entegra coach	Gabriel	Upgrade	Entegra coach	Gabriel	Upgrade	Entegra coach	Gabriel	Upgrade	Entegra coach	Gabriel	Upgrade
10-13976-000	85918	89449	8C24-18045-DA	G63622		9U9Z18124A	83209	89414	ASH-1229	89414	
10-13976-000	89449		8C24-18080-DB	G63623		9U9Z18124A	89414		ASH-1230	83122	89406
1013976000	85918	89449	8C2418045DA	G63622		9U9Z18125A	83122	89406	ASH-1230	89406	
1013976000	89449		8C2418080DB	G63623		9U9Z18125A	89406		ASH-137	83122	89406
16-16764-000	85724	89443	8C2Z-18124-D	G63622		ASH-1022	83209	89414	ASH-137	89406	
16-16764-000	89443		8C2Z-18125-D	G63623		ASH-1022	89414		ASH-25820	85005	89430
1616764000	85724	89443	8C2Z18124D	G63622		ASH-1023	83122	89406	ASH-25820	89430	
1616764000	89443		8C2Z18125D	G63623		ASH-1023	89406		ASH-25821	85006	
1C34-18045-AA	83209	89414	9U94-18045-AA	83209	89414	ASH-1136	G63623		ASH-25822	83209	89414
1C34-18045-AA	89414		9U94-18045-AA	89414		ASH-1154	G63622		ASH-25822	89414	
1C34-18045-JA	83209	89414	9U94-18080-AA	83122	89406	ASH-1161	85006		ASH-25823	83209	89414
1C34-18045-JA	89414		9U94-18080-AA	89406		ASH-1162	85005	89430	ASH-25823	89414	
1C3418045AA	83209	89414	9U9418045AA	83209	89414	ASH-1162	89430		ASH-25824	83122	89406
1C3418045AA	89414		9U9418045AA	89414		ASH-1205	83209	89414	ASH-25824	89406	
1C3418045JA	83209	89414	9U9418080AA	83122	89406	ASH-1205	89414		ASH-294	83209	89414
1C3418045JA	89414		9U9418080AA	89406		ASH-1206	83122	89406	ASH-294	89414	
58913-009	85959		9U9Z-18124-A	83209	89414	ASH-1206	89406				
58913-009L	85959		9U9Z-18124-A	89414		ASH-1228	83209	89414			
58913009	85959		9U9Z-18125-A	83122	89406	ASH-1228	89414				
58913009L	85959		9U9Z-18125-A	89406		ASH-1229	83209	89414			

**Important Note:** Competitive Interchanges are to be used for stocking purposes only. Where multiple crosses are identified, please reference the applications section of this catalog. / **Remarque importante:** Les interchanges concurrentiels ne s'utilisent qu'aux fins de stocks. Dans le cas de rferences multiples, consulter la section des applications du catalogue. / **Nota importante:** Dans le cas de rferences multiples, consulter la section des applications du catalogue. / **Nota importante:** Se pueden usar intercambios competitivos para propósitos de almacenamiento solamente. Cuando se identifican intercambios múltiples, consulte la sección de aplicaciones de este catálogo.

**COMPETITIVE & O.E.M. INTERCHANGE LIST**  
**Lista de Intercambios contra Competidores y Equipo Original.**  
**Liste d'interchange de produits comptitifs & d'equipement original (OEM)**

**Entegra Coach... cont'd**

Entegra coach	Gabriel	Upgrade	Entegra coach	Gabriel	Upgrade	Entegra coach	Gabriel	Upgrade	Entegra coach	Gabriel	Upgrade
ASH1022	83209	89414	ASH1206	89406		ASH25822	83209	89414	AT-621	83122	89406
ASH1022	89414		ASH1228	83209	89414	ASH25822	89414		AT-621	89406	
ASH1023	83122	89406	ASH1228	89414		ASH25823	83209	89414	AT-766	83209	89414
ASH1023	89406		ASH1229	83209	89414	ASH25823	89414		AT-766	89414	
ASH1136	G63623		ASH1229	89414		ASH25824	83122	89406	AT163G	G63622	
ASH1154	G63622		ASH1230	83122	89406	ASH25824	89406		AT164G	G63623	
ASH1161	85006		ASH1230	89406		ASH294	83209	89414	AT620	83209	89414
ASH1162	85005	89430	ASH137	83122	89406	ASH294	89414		AT620	89414	
ASH1162	89430		ASH137	89406		AT-163G	G63622		AT621	83122	89406
ASH1205	83209	89414	ASH25820	85005	89430	AT-164G	G63623		AT621	89406	
ASH1205	89414		ASH25820	89430		AT-620	83209	89414	AT766	83209	89414
ASH1206	83122	89406	ASH25821	85006		AT-620	89414		AT766	89414	

**Euclid**

Euclid	Gabriel	Upgrade	Euclid	Gabriel	Upgrade	Euclid	Gabriel	Upgrade	Euclid	Gabriel	Upgrade
E14009	85933	89454	E83221	83221		E85007	85007		E85310	89423	
E14009	89454		E83225	83225		E85010	85010		E85311	85311	89424
E14021	85955		E83242	83242		E85012	85012	89413	E85311	89424	
E14022	85955		E83301	83301		E85012	89413		E85312	85733	
E14037	85967		E83303	83303		E85013	85013	89414	E85314	85314	89425
E14042	85965		E83308	83308		E85013	89414		E85314	89425	
E14045	83143		E83309	83309		E85014	85014		E85318	85318	
E14046	83142		E83310	83221		E85024	85024		E85700	85700	
E83200	89402		E83312	83312	89409	E85026	85026		E85702	85702	
E83203	83203	89436	E83312	89409		E85029	85029		E85704	85704	
E83203	89436		E83314	83314		E85030	85030	89440	E85705	85705	89447
E83204	83204		E83318	83318		E85030	89440		E85705	89447	
E83205	83209	89414	E83353	85740		E85300	85300	89419	E85709	85709	
E83205	89414		E83400	83400		E85300	89419		E85711	85711	
E83207	83207	89407	E83401	83401		E85302	85302	89420	E85712	85712	
E83207	89407		E85000	85000	89436	E85302	89420		E85713	85713	
E83209	83209	89414	E85000	89436		E85303	85303	89422	E87000	85711	
E83209	89414		E85001	85001	89410	E85303	89422		E87001	85734	
E83214	83214		E85001	89410		E85304	85304		E87003	85700	
E83215	83215		E85003	85003	89411	E85305	85305		E87006	85736	
E83216	83216		E85003	89411		E85307	85307		E87012	85705	89447
E83218	83122	89406	E85005	85005	89430	E85308	85308	89422	E87012	89447	
E83218	89406		E85005	89430		E85308	89422				
E83219	83219		E85006	85006		E85310	85310	89423			

**FCS**

Fcs	Gabriel	Upgrade	Fcs	Gabriel	Upgrade	Fcs	Gabriel	Upgrade	Fcs	Gabriel	Upgrade
1331048L	G57278		1331588L	G57098		1331605R	G57131		1331626L	G57664	
1331048R	G57279		1331588R	G57097		1331607L	G57192		1331626R	G57663	
1331060L	G57167		1331595L	G57119		1331607R	G57193		1331628L	G57372	
1331060R	G57168		1331595L	G57606		1331612L	G57152		1331628L	G57375	
1331089	G57397		1331595R	G57120		1331612R	G57153		1331628R	G57373	
1331301L	G57114		1331595R	G57605		1331613L	G57533		1331628R	G57376	
1331520L	G57203		1331596L	G57157		1331613R	G57534		1331629L	G57391	
1331520R	G57202		1331596R	G57158		1331617L	G57357		1331629R	G57390	
1331573L	G57037		1331597L	G57163		1331617R	G57358		1331630L	G57084	
1331573R	G57038		1331597R	G57164		1331620L	G57404		1331630R	G57085	
1331579L	G57275		1331601L	G57114		1331620R	G57405		1331631L	G57084	
1331579R	G57276		1331601R	G57115		1331621L	G57444		1331631R	G57085	
1331581	G57274		1331604L	G57105		1331621R	G57444		1331632L	G57222	
1331582L	G57190		1331604L	G57350		1331622L	G57204				
1331582R	G57191		1331604R	G57106		1331622R	G57205				
1331584L	G57110		1331604R	G57349		1331625L	G57666				
1331584R	G57111		1331605L	G57130		1331625R	G57665				

**Important Note:** Competitive Interchanges are to be used for stocking purposes only. Where multiple crosses are identified, please reference the applications section of this catalog. / **Remarque importante:** Les interchanges concurrentiels ne s'utilisent qu'aux fins de stocks. Dans le cas de rferences multiples, consulter la section des applications du catalogue. / **Nota importante:** Dans le cas de rferences multiples, consulter la section des applications du catalogue. / **Nota importante:** Se pueden usar intercambios competitivos para propósitos de almacenamiento solamente. Cuando se identifican intercambios múltiples, consulte la sección de aplicaciones de este catálogo.



**COMPETITIVE & O.E.M. INTERCHANGE LIST**  
**Lista de Intercambios contra Competidores y Equipo Original.**  
**Liste dinterchange de produits comptitifs & dquipement original (OEM)**

FCS... cont'd

Fcs	Gabriel	Upgrade	Fcs	Gabriel	Upgrade	Fcs	Gabriel	Upgrade	Fcs	Gabriel	Upgrade
1331632R	G57223		1331796R	G57140		1332345	G57014		1333307R	G57628	
1331634L	G57333		1331799L	G57398		1332347L	G56924		1333319L	G57481	
1331634R	G57334		1331799R	G57399		1332347R	G56925		1333319R	G57482	
1331642L	G57558		1331802L	G57167		1332348	G57060		1333320L	G57659	
1331642R	G57559		1331802R	G57168		1332349	G57271		1333320R	G57658	
1331645L	G57144		1331803L	G57400		1332350L	G57030		1333354L	G56925	
1331645R	G57145		1331803R	G57401		1332350R	G57031		1333354R	G56924	
1331646L	G57184		1331818	G57142		1332352L	G57045		1333355L	G57393	
1331646R	G57185		1331821	G57206		1332352R	G57046		1333355R	G57394	
1331648L	G57200		1331826L	G57268		1332353	G56929		1333363L	G57582	
1331648R	G57201		1331826R	G57269		1332354	G57005		1333363L	G57583	
1331660L	G57150		1331839L	G57161		1332354	G57006		1333363R	G57583	
1331660R	G57151		1331839R	G57162		1332355L	G57034		1333365L	G57331	
1331685L	G57112		1331847L	G57126		1332355R	G57035		1333365R	G57332	
1331685R	G57113		1331847R	G57127		1332356L	G57047		1333376L	G57500	
1331688L	G57583		1331900L	G57218		1332356R	G57048		1333376R	G57499	
1331688R	G57282		1331900R	G57219		1332357L	G57049		1333377L	G57500	
1331702L	G57489		1331901L	G57343		1332357R	G57050		1333377R	G57499	
1331702R	G57490		1331901R	G57344		1332358L	G57049		1333378L	G57587	
1331715L	G57560		1331908L	G57471		1332358R	G57050		1333378R	G57586	
1331715R	G57561		1331908R	G57472		1332360L	G57078		1333379L	G57152	
1331733	G57051		1331911L	G57645		1332360R	G57079		1333379L	G57587	
1331734	G57141		1331911R	G57644		1332362L	G56932		1333379R	G57153	
1331745L	G57341		1331931	G57324		1332362R	G56933		1333379R	G57586	
1331745R	G57342		1332301	G56927		1332363L	G56930		1333380L	G57587	
1331747L	G57460		1332302	G56938		1332363R	G56931		1333380R	G57586	
1331747R	G57459		1332303	G57060		1332366L	G57372		1333392L	G57197	
1331752L	G57460		1332304L	G56924		1332366R	G57373		1333392R	G57198	
1331753L	G57460		1332304R	G56925		1332367L	G57076		1333393L	G57562	
1331758L	G57345		1332305L	G56930		1332367R	G57077		1333393R	G57563	
1331758R	G57346		1332305R	G56931		1332368L	G57041		1333395L	G57564	
1331759L	G57515		1332306L	G56932		1332368R	G57042		1333395R	G57565	
1331759R	G57516		1332306R	G56933		1332369L	G57043		1333402L	G57266	
1331762L	G57339		1332307	G56928		1332369R	G57044		1333402R	G57267	
1331762R	G57340		1332319L	G56956		1333270L	G57069		1333404	G57109	
1331763L	G57341		1332319R	G56957		1333270L	G57121		1333404	G57314	
1331763R	G57342		1332320	G56951		1333270R	G57070		1333406L	G57465	
1331767L	G57635		1332322L	G56962		1333270R	G57122		1333406R	G57466	
1331767R	G57634		1332322R	G56963		1333271L	G57473		1333412L	G57566	
1331775L	G57369		1332323L	G56948		1333271R	G57474		1333412R	G57567	
1331775R	G57370		1332323R	G56948		1333283L	G57473		1333414L	G57377	
1331783L	G57193		1332324L	G56949		1333283R	G57474		1333414R	G57378	
1331783R	G57192		1332324R	G56950		1333290	G57099		1333415L	G57377	
1331785L	G57152		1332326L	G56924		1333290	G57100		1333415R	G57378	
1331785L	G57533		1332326R	G56925		1333291L	G57137		1333426L	G57494	
1331785R	G57153		1332327	G57060		1333291R	G57138		1333426R	G57493	
1331785R	G57534		1332328L	G56973		1333296L	G57330		1333431L	G57629	
1331786L	G57613		1332328R	G56974		1333296R	G57329		1333431R	G57628	
1331786R	G57612		1332334	G56975		1333298	G57040		1333432L	G57677	
1331789L	G57176		1332335	G56965		1333299L	G57110		1333432R	G57676	
1331789L	G57464		1332338L	G56932		1333299L	G57535		1333433L	G57659	
1331789R	G57177		1332338R	G56933		1333299R	G57111		1333433R	G57658	
1331789R	G57463		1332342L	G57011		1333299R	G57536		1333434L	G57659	
1331794L	G57088		1332342R	G57012		1333305L	G57112		1333434R	G57658	
1331794R	G57089		1332343	G57051		1333305R	G57113		1333435L	G57483	
1331796L	G57139		1332344	G57013		1333307L	G57629		1333435L	G57659	

**Important Note:** Competitive Interchanges are to be used for stocking purposes only. Where multiple crosses are identified, please reference the applications section of this catalog./ **Remarque importante:** Les interchanges concurrentiels ne s'utilisent qu'aux fins de stocks. Dans le cas de rfrences multiples, consulter la section des applications du catalogue./ **Nota importante:** Dans le cas de rfrences multiples, consulter la section des applications du catalogue./ **Nota importante:** Se pueden usar intercambios competitivos para propósitos de almacenamiento solamente. Cuando se identifican intercambios múltiples, consulte la sección de aplicaciones de este catálogo.

**COMPETITIVE & O.E.M. INTERCHANGE LIST**  
**Lista de Intercambios contra Competidores y Equipo Original.**  
**Liste dinterchange de produits comptitifs & dquipement original (OEM)**

**FCS... cont'd**

Fcs	Gabriel	Upgrade	Fcs	Gabriel	Upgrade	Fcs	Gabriel	Upgrade	Fcs	Gabriel	Upgrade
1333435R	G57484		1333529L	G57812		1335849L	G57390		1336340L	G57033	
1333435R	G57658		1333529R	G57812		1335849R	G57390		1336340L	G57061	
1333438L	G57674		1333548L	G57192		1335850	G57071		1336340R	G57032	
1333438R	G57673		1333548R	G57193		1335875L	G57194		1336340R	G57062	
1333439L	G57339		1333549L	G57266		1335875R	G57195		1336341L	G57065	
1333439R	G57340		1333549R	G57267		1335876L	G57497		1336341R	G57066	
1333440L	G57604		1333565L	G57161		1335876R	G57498		1336342	G57026	
1333440R	G57603		1333565R	G57162		1335877L	G57724		1336343	G57080	
1333443L	G57695		1333714L	G57716		1335877R	G57725		1336347L	G57054	
1333443R	G57696		1333714R	G57717		1335883L	G57764		1336347R	G57055	
1333444L	G57190		1333719L	G57543		1335883R	G57765		1336348	G57056	
1333444R	G57191		1333719R	G57544		1335892L	G57726		1336349	G57080	
1333447L	G57689		1333745L	G57780		1335892R	G57727		1337006L	G57774	
1333447R	G57690		1333745R	G57781		1335893L	G57724		1337006R	G57775	
1333448L	G57152		1333790L	G57480		1335893R	G57725		1337023L	G57800	
1333448R	G57153		1333790R	G57479		1335896L	G57517		1337023R	G57801	
1333450L	G57693		1333816L	G57780		1335896R	G57518		1345395	G57159	
1333450R	G57694		1333816R	G57781		1335897L	G57517		1345395	G57160	
1333451L	G57699		1333817L	G57076		1335897R	G57518		1345399	G57075	
1333451R	G57700		1333817R	G57077		1335924L	G57161		1345401	G57159	
1333452L	G57218		1333919L	G57852		1335924R	G57162		1345401	G57160	
1333452R	G57219		1333919R	G57853		1336301L	G57063		1345403L	G57424	
1333454L	G57712		1333926L	G57782		1336301R	G57064		1345403R	G57425	
1333454R	G57713		1333926R	G57783		1336302	G56934		1345404L	G57067	
1333462L	G57697		1335383L	G57353		1336302	G56937		1345404R	G57068	
1333462R	G57698		1335383R	G57354		1336303	G56936		1345409L	G57444	
1333464L	G57645		1335527L	G57270		1336304	G56935		1345409R	G57444	
1333464R	G57644		1335527R	G57270		1336305L	G56991		1345411L	G57133	
1333466L	G57390		1335543L	G57148		1336305R	G56992		1345411R	G57134	
1333466R	G57391		1335543R	G57148		1336306	G57039		1345416L	G57086	
1333467L	G57549		1335556	G57059		1336312	G56943		1345416R	G57087	
1333467R	G57550		1335562L	G57135		1336313	G56964		1345417L	G57414	
1333468L	G57322		1335562R	G57136		1336315	G56998		1345417R	G57415	
1333468R	G57323		1335576	G57156		1336316	G57057		1345455	G57282	
1333471L	G57193		1335576	G57277		1336316	G57058		1345459L	G57090	
1333471R	G57192		1335582	G57083		1336318	G56995		1345459R	G57091	
1333475L	G57722		1335582L	G57083		1336322L	G56993		1345469L	G57107	
1333475R	G57723		1335582R	G57083		1336322R	G56994		1345469R	G57108	
1333477L	G57496		1335604L	G57128		1336323	G57018		1345470	G57423	
1333477R	G57495		1335604R	G57129		1336324	G57022		1345471L	G57428	
1333489L	G57746		1335664	G57149		1336325L	G57010		1345471R	G57429	
1333489R	G57747		1335682L	G57363		1336325R	G57010		1345477	G57421	
1333490	G57709		1335682R	G57364		1336326	G57020		1345484	G57178	
1333491L	G57730		1335778	G57071		1336327	G57015		1345497	G57092	
1333491R	G57731		1335778	G57072		1336327	G57212		1345540	G57096	
1333492L	G57734		1335779L	G57081		1336328	G57016		1345541	G57703	
1333492R	G57735		1335779R	G57082		1336329L	G57007		1345555	G57125	
1333494L	G57739		1335790	G57427		1336329R	G57008		1345556	G57146	
1333494R	G57738		1335795L	G57337		1336330	G57017		1345557	G57118	
1333495	G57142		1335795R	G57338		1336331	G57021		1345557	G57413	
1333503L	G57803		1335797L	G57207		1336332	G57019		1345558L	G57123	
1333503R	G57804		1335797R	G57417		1336333	G57023		1345558L	G57220	
1333511L	G57776		1335801L	G57595		1336334	G57053		1345558R	G57124	
1333511R	G57776		1335801R	G57594		1336337L	G56996		1345558R	G57221	
1333524L	G57784		1335848L	G57359		1336337R	G56997		1345559	G57095	
1333524R	G57785		1335848R	G57360		1336339	G57036		1345560	G57172	

**Important Note:** Competitive Interchanges are to be used for stocking purposes only. Where multiple crosses are identified, please reference the applications section of this catalog. / **Remarque importante:** Les interchanges concurrentiels ne s'utilisent qu'aux fins de stocks. Dans le cas de références multiples, consulter la section des applications du catalogue. / **Nota importante:** Dans le cas de referencias multiples, consultar la sección de aplicaciones del catálogo. / **Nota importante:** Se pueden usar intercambios competitivos para propósitos de almacenamiento solamente. Cuando se identifican intercambios múltiples, consulte la sección de aplicaciones de este catálogo.

**COMPETITIVE & O.E.M. INTERCHANGE LIST**  
**Lista de Intercambios contra Competidores y Equipo Original.**  
**Liste d'interchange de produits compititifs & d'equipement original (OEM)**

FCS... cont'd

Fcs	Gabriel	Upgrade	Fcs	Gabriel	Upgrade	Fcs	Gabriel	Upgrade	Fcs	Gabriel	Upgrade
1345561	G57173		2331595R	G57120		2333363R	G57582		2335543R	G57148	
1345562	G57103		2331604L	G57350		2333365L	G57480		2335576	G57680	
1345563	G57103		2331604R	G57349		2333365R	G57479		2335582L	G57083	
1345564L	G57027		2331613L	G57533		2333376L	G57500		2335582R	G57083	
1345564R	G57027		2331613R	G57534		2333376R	G57499		2335779L	G57081	
1345565L	G57027		2331622L	G57204		2333378L	G57152		2335779R	G57082	
1345565R	G57027		2331622R	G57205		2333378R	G57153		2335790	G57427	
1345566L	G57133		2331629L	G57390		2333392L	G57197		2335790R	G57427	
1345566R	G57134		2331629R	G57391		2333392I	G57322		2335797L	G57418	
1345567	G57147		2331632L	G57222		2333392R	G57198		2335797R	G57417	
1345568	G57420		2331632R	G57223		2333392R	G57323		2335801L	G57455	
1345682	G57646		2331645L	G57144		2333393L	G57720		2335801R	G57456	
1345683	G57447		2331645R	G57145		2333393R	G57721		2335849L	G57449	
1345685L	G57419		2331688L	G57583		2333406L	G57465		2335849R	G57450	
1345685R	G57419		2331688R	G57282		2333406R	G57466		2335850	G57071	
1345687	G57095		2331747L	G57459		2333412L	G57566		2335876L	G57497	
1345688L	G57416		2331747R	G57460		2333412R	G57567		2335876R	G57498	
1345688R	G57682		2331762L	G57339		2333414L	G57378		2335883L	G57764	
1345689L	G57451		2331762R	G57340		2333414R	G57377		2335883R	G57765	
1345689R	G57452		2331785L	G57153		2333415L	G57377		2335893R	G57727	
1345695	G57706		2331785R	G57152		2333415R	G57378		2335897L	G57517	
1345721L	G57480		2331794L	G57088		2333438L	G57674		2335897R	G57518	
1345721L	G57597		2331794R	G57089		2333438R	G57673		2336305L	G56991	
1345721R	G57479		2331796L	G57139		2333444L	G57190		2336306	G57039	
1345721R	G57598		2331796R	G57140		2333444R	G57191		2336324	G57022	
1345741L	G57451		2331821	G57206		2333445L	G57701		2336329L	G57007	
1345741R	G57452		2331839L	G57161		2333445R	G57702		2336329R	G57008	
1345742L	G57572		2331839R	G57162		2333447L	G57689		2336338	G57422	
1345742R	G57573		2331852L	G57539		2333447R	G57690		2336338	G57423	
1345750	G57447		2331852R	G57540		2333450L	G57691		2336347	G57056	
1345761	G57675		2331908L	G57471		2333450R	G57692		2337006L	G57774	
1345762	G57675		2331908R	G57472		2333451L	G57697		2337006R	G57775	
1345763	G57703		2331931	G57324		2333451R	G57698		2345455	G57282	
1345768	G57703		2332304L	G56924		2333467L	G57549		2345484	G57607	
1345815	G57000		2332304R	G56925		2333467R	G57550		2345497	G57092	
1345816R	G57683		2332350L	G57030		2333489L	G57746		2345540	G57096	
1345837R	G57683		2332350R	G57031		2333489R	G57747		2345541	G57703	
1345844	G57794		2332352L	G57045		2333491L	G57730		2345556	G57409	
1345845L	G57192		2332352R	G57046		2333491R	G57731		2345558L	G57123	
1345845R	G57193		2332357L	G57049		2333492L	G57733		2345558R	G57124	
1345849L	G57454		2332357R	G57050		2333492R	G57732		2345559	G57095	
1345849R	G57453		2332367L	G57076		2333494L	G57738		2345561	G57173	
1345880	G57683		2332367R	G57077		2333494R	G57739		2345682	G57647	
1345959	G57799		2332368L	G57041		2333511L	G57777		2345721L	G57480	
1346088	G57343		2332368R	G57042		2333511R	G57777		2345721R	G57479	
1346088	G57344		2333296L	G57329		2333714L	G57716		2345742L	G57451	
1346361L	G57133		2333296R	G57330		2333714R	G57717		2345742R	G57452	
1346361R	G57134		2333319L	G57481		2333745L	G57780		2345750	G57579	
1355057	G57683		2333319R	G57482		2333745R	G57781		2345763	G57703	
2331579L	G57275		2333320L	G57659		2333816L	G57780		2345815	G57000	
2331579R	G57276		2333320R	G57658		2333816R	G57781		2345844	G57794	
2331582L	G57190		2333354L	G56924		2333817L	G57076		2345849L	G57454	
2331582R	G57191		2333354R	G56925		2333817R	G57077		2345849R	G57453	
2331590L	G57613		2333355L	G57393		2335527L	G57270		2345881	G57748	
2331590R	G57612		2333355R	G57394		2335527R	G57270		331008L	G56538	
2331595L	G57119		2333363L	G57583		2335543L	G57148		331008R	G56537	

**Important Note:** Competitive Interchanges are to be used for stocking purposes only. Where multiple crosses are identified, please reference the applications section of this catalog. / **Remarque importante:** Les interchanges concurrentiels ne s'utilisent qu'aux fins de stocks. Dans le cas de références multiples, consulter la section des applications du catalogue. / **Nota importante:** Dans le cas de références multiples, consulter la section des applications du catalogue. / **Nota importante:** Se pueden usar intercambios competitivos para propósitos de almacenamiento solamente. Cuando se identifican intercambios múltiples, consulte la sección de aplicaciones de este catálogo.

**COMPETITIVE & O.E.M. INTERCHANGE LIST**  
**Lista de Intercambios contra Competidores y Equipo Original.**  
**Liste dinterchange de produits comptitifs & dquipement original (OEM)**

**FCS... cont'd**

Fcs	Gabriel	Upgrade	Fcs	Gabriel	Upgrade	Fcs	Gabriel	Upgrade	Fcs	Gabriel	Upgrade
331019L	G56634		331674L	G52260		332324R	G55662		3333445R	G57702	
331019R	G56633		331674R	G52261		332334	G55892		3333467L	G57549	
331060L	G56640		331688R	G56841		332335	G55896		3333467R	G57550	
331060R	G56641		331692	G55681		332343	G56509		3333489L	G57744	
331579L	G52154		331700	G56778		332349	G56817		3333489R	G57745	
331579R	G52155		331709L	G52017		332350L	G56671		333354	G55949	
331587	G56802		331709R	G52018		332350R	G56672		333355L	G52156	
331588L	G55993		331713L	G52144		332352L	G56601		333355R	G52157	
331588R	G55994		331713R	G52145		332352R	G56568		3333564L	G57772	
331597L	G52008		331715L	G52249		332356	G56810		3333564R	G57773	
331597R	G52009		331715R	G52250		332357L	G56621		333356L	G52255	
331601L	G56661		331716L	G52140		332357R	G56622		333356R	G52256	
331601R	G56660		331716R	G52141		332366L	G55993		333363L	G52351	
331603L	G56615		331727	G55948		332366R	G55994		333363R	G52352	
331603R	G56616		331733	G56509		3331582L	G57190		333365L	G52187	
331604L	G56582		331741L	G52184		3331582R	G57191		333365R	G52188	
331604R	G56581		331741R	G52185		3331595L	G57119		333379L	G56732	
331607L	G52103		331773	G52098		3331595R	G57120		333379R	G56733	
331607R	G52104		331775L	G52096		3331622L	G57204		333392L	G52127	
331617L	G52013		331775R	G52097		3331622R	G57205		333392R	G52128	
331617R	G52014		331778L	G52026		3331660L	G57151		333393L	G52201	
331622L	G52004		331778R	G52027		3331660R	G57150		333393R	G52202	
331622R	G52007		331783L	G52103		3331821L	G57206		333402L	G52131	
331625L	G52105		331783R	G52104		3331821R	G57206		333402R	G52131	
331625R	G52106		331789L	G52081		3332304L	G56924		333404	G52125	
331626L	G52107		331789R	G52082		3332304R	G56925		333406L	G52117	
331626R	G52108		331796L	G56562		333283L	G52173		333406R	G52118	
331628L	G52107		331796R	G56561		333283R	G52174		333426L	G52382	
331628R	G52108		331802L	G52335		333290	G56809		333426R	G52383	
331630L	G56800		331802R	G52336		333292	G55551		333431L	G52374	
331631L	G56800		331818	G52025		333296L	G52245		333431R	G52375	
331631R	G56799		331820	G56700		333296R	G52246		333435L	G52203	
331632L	G52112		331821	G52131		333297	G56701		333435R	G52204	
331632R	G52113		331825L	G55591		333319L	G52201		333440L	G52152	
331633L	G52282		331825R	G55591		333319R	G52202		333440R	G52153	
331633R	G52283		331845L	G52182		3333296L	G57329		333443L	G52360	
331634L	G52150		331845R	G52183		3333296R	G57330		333443R	G52361	
331634R	G52151		331908L	G52158		3333354L	G56924		333453L	G52209	
331639L	G55999		331908R	G52159		3333354R	G56925		333453R	G52210	
331639R	G55999		331909L	G52247		3333363L	G57583		333494L	G52331	
331644L	G56687		331909R	G52248		3333363R	G57282		333494R	G52332	
331644R	G56688		331931	G52116		3333392L	G57197		333504L	G52329	
331645L	G56615		332302	G55825		3333392R	G57198		333504R	G52330	
331645R	G56616		332303	G55948		3333393L	G57720		333507L	G52280	
331646L	G52032		332304	G55949		3333393R	G57721		333507R	G52281	
331646R	G52033		332305L	G56506		3333406L	G57465		3335576	G57156	
331648L	G52094		332305R	G56514		3333406R	G57466		333560L	G52260	
331648R	G52095		332306L	G55675		3333412L	G57329		333560R	G52261	
331660L	G56679		332306R	G55676		3333412R	G57330		333564L	G52524	
331660R	G56680		332312	G56718		3333414L	G57377		333564R	G52525	
331661L	G52168		332316	G55697		3333414R	G57378		3335779L	G57081	
331661R	G52169		332317	G55698		3333415L	G57377		3335779R	G57082	
331668L	G56530		332319	G56620		3333415R	G57378		3335797L	G57208	
331668R	G56529		332323L	G55999		3333444L	G57190		3335797R	G57207	
331669L	G56530		332323R	G55999		3333444R	G57191		3335801L	G57455	
331669R	G56529		332324L	G55661		3333445L	G57701		3335801R	G57456	

**Important Note:** Competitive Interchanges are to be used for stocking purposes only. Where multiple crosses are identified, please reference the applications section of this catalog. / **Remarque importante:** Les interchanges concurrentiels ne s'utilisent qu'aux fins de stocks. Dans le cas de références multiples, consulter la section des applications du catalogue. / **Nota importante:** Dans le cas de références multiples, consulter la section des applications du catalogue. / **Nota importante:** Se pueden usar intercambios competitivos para propósitos de almacenamiento solamente. Cuando se identifican intercambios múltiples, consulte la sección de aplicaciones de este catálogo.

**COMPETITIVE & O.E.M. INTERCHANGE LIST**  
**Lista de Intercambios contra Competidores y Equipo Original.**  
**Liste d'interchange de produits compititifs & d'equipement original (OEM)**

FCS... cont'd

Fcs	Gabriel	Upgrade	Fcs	Gabriel	Upgrade	Fcs	Gabriel	Upgrade	Fcs	Gabriel	Upgrade
3335876L	G57497		336329	G51728		341553	G63813		341715	70037	
3335876R	G57498		336330	G51722		341554	81478		341716	70013	
3336329L	G57007		336332	G51723		341556	81478		341952	G64047	
3336329R	G57008		336333	G51870		341557	G51812		341962	G51807	
3336347L	G57055		336334	G51758		341558	G51802		341964	70049	
3336347R	G57054		336338	G51268		341559	G51798		341967	69575	
3345484	G57607		336340	G51700		341560	G51803		341974	81870	
3345497	G57144		336341	G51077		341561	70041		341979	69946	
3345497	G57145		336343	G51887		341562	G64027		341980	69450	
3345559	G57095		336348	G51738		341567	81916		342129	G63299	
3345682	G57646		336349	G51888		341568	81744		342390	81935	
3345742L	G57572		341012	82156		341570	G51721		342445	81878	
3345742R	G57573		341092	70000		341573	81582		342462	81726	
335027	G55820		341347	69863		341574	G63410		342464	82001	
3355037	G57023		341424	70003		341575	81713		342465	G64003	
335523L	G51813		341511	81668		341576	81744		342466	81667	
335523R	G51814		341512	81713		341577	81744		342467	81039	
335531L	G51761		341513	81541		341578	81912		342467	81496	
335531R	G51760		341514	81490		341579	81914		342468	81926	
335533	G51267		341514	81836		341580	G63886		342470	69473	
335541	G56655		341516	G63862		341581	81833		342471	69590	
335542L	G52110		341517	69625		341582	81828		342472	81730	
335542R	G52111		341517	81446		341583	G64037		342472	81891	
335543L	G51859		341517	81492		341584	81892		342472	81917	
335543R	G51859		341517	81494		341585	81913		342473	69591	
335552	G55901		341517	81495		341586	81935		342474	69787	
335555L	G52274		341518	81548		341587	69592		342475	G63842	
335555R	G52275		341519	81893		341588	81794		342476	81930	
335556	G51714		341520	82155		341590	69962		342477	G63868	
335559	G51740		341522	69863		341593	G63884		342478	81318	
335561	G51097		341523	G51807		341594	G63894		342479	81871	
335576	G56899		341524	69907		341595	81922		342480	81147	
335582	G56807		341526	70020		341596	G63895		342481	G64026	
335583L	G51813		341527	81935		341597	81920		342484	G63937	
335583R	G51814		341528	81872		341598	81925		342485	G63875	
335586	G56565		341529	G51805		341599	81920		342486	81147	
335605	G51718		341530	81869		341600	81904		342487	82066	
335632L	G52314		341531	81922		341603	70013		342488	81910	
335632R	G52314		341532	G63885		341608	69420		342489	70027	
335664	G51806		341533	G63832		341613	81481		342490	G63883	
335666	G51806		341534	G63860		341615	69589		342491	G63878	
335779L	G56836		341535	G63860		341617	81934		342492	G64028	
335779R	G56837		341537	G64087		341623	70028		342493	81318	
335811	G52276		341538	G64087		341624	70055		342494	81923	
335836L	G51920		341539	G51805		341627	81936		342496	81821	
335836R	G51921		341540	81416		341629	81691		342496	81905	
336301L	G56516		341541	G63937		341635	70036		342496	81918	
336301R	G56517		341542	G63889		341638	81933		342500	G63717	
336303	G55901		341543	G64006		341639	81928		342501	81082	
336306	G56606		341544	G64038		341640	81932		342501	81510	
336311L	G52005		341545	70060		341641	81919		342501	81710	
336311R	G52006		341546	G55821		341642	G63958		342502	G63809	
336313	G55856		341548	81911		341643	G64011		342505	G63717	
336315	G55910		341550	G63828		341645	81096		342506	81890	
336316	G51087		341551	G63815		341649	82138		342507	G63870	
336325	G51077		341552	81507		341688	G51874		342508	G63867	

**Important Note:** Competitive Interchanges are to be used for stocking purposes only. Where multiple crosses are identified, please reference the applications section of this catalog. / **Remarque importante:** Les interchanges concurrentiels ne s'utilisent qu'aux fins de stocks. Dans le cas de rfrences multiples, consulter la section des applications du catalogue. / **Nota importante:** Dans le cas de rfrences multiples, consulter la section des applications du catalogue. / **Nota importante:** Se pueden usar intercambios competitivos para propósitos de almacenamiento solamente. Cuando se identifican intercambios múltiples, consulte la sección de aplicaciones de este catálogo.

**COMPETITIVE & O.E.M. INTERCHANGE LIST**  
**Lista de Intercambios contra Competidores y Equipo Original.**  
**Liste dinterchange de produits comptitifs & dquipement original (OEM)**

FCS... cont'd

Fcs	Gabriel	Upgrade	Fcs	Gabriel	Upgrade	Fcs	Gabriel	Upgrade	Fcs	Gabriel	Upgrade
342509	G63810		342844	70203		345556	G51815		346324	G51971	
342510	G63808		342845	G64031		345563	G51864		346341	G511030	
342511	G63810		342846	G64121		345567	G51856		346343	70086	
342512	81710		342848	G64148		345681	G51765		346367	G63885	
342513	G63873		342856	G64040		345682	G51766		346370	G511142	
342516	81516		342873	G64104		345683	G51863		346410	G511000	
342517	G63879		342875	70203		345685	G51892		346443	70207	
342518	G63882		342889	69591		345688	G51879		346449	G511038	
342519	81482		342905	70098		345689	G51898		346452	G51990	
342527	81873		342922	G64143		345691	G51860		347007	G64048	
342528	81931		342944	G64186		345692	G51861		347015	G64186	
342529	81921		342946	G64012		345694	G51865		347023	G64050	
342534	G63918		342949	G64031		345695	G51961		347037	G63888	
342536	69585		343308	81270		345734	G51848		347072	70098	
342537	G64032		343329	82004		345742	G51898		4331622L	G57204	
342540	G64003		343330	82125		345750	G51863		4331622R	G57205	
342541	69724		343339	82126		345764L	G511054		4331660L	G57151	
342542	81492		344312	81076		345764R	G511055		4331660R	G57150	
342542	81494		345315	G51794		345766	G51922		4331821L	G57206	
342542	81514		345378	G51795		345825	G51916		4331821R	G57206	
342543	G63776		345395	G51727		345826	G51975		4333363L	G57583	
342546	69587		345398	G51767		346017	70052		4333363R	G57282	
342547	G64015		345401	G51727		346031	G51884		4333392L	G57197	
342549	81676		345402	G51910		346051	G63726		4333392R	G57198	
342549	82007		345403	G51858		346052	82090		4333406L	G57465	
342550	69587		345404	G51736		346054	70055		4333406R	G57466	
342551	G63872		345405	G51739		346056	G63815		4333489L	G57744	
342554	81549		345408	G55804		346057	G51966		4333489R	G57745	
342555	81549		345412	G51477		346066	G51971		4335790	G57427	
342556	G64012		345413	G51738		346087	G64056		4345497	G57118	
342557	G63844		345414	G51716		346088	G64216		5331821L	G57206	
342558	81929		345417	G51880		346090	G51905		5331821R	G57206	
342561	81923		345419	G51715		346091	G511134		5333392L	G57197	
342564	G63962		345430	G51883		346092	70078		5333392R	G57198	
342565	81873		345433	G51980		346093	70068		5333406L	G57465	
342567	81496		345434	G51794		346099	G51980		5333406R	G57466	
342572	G63866		345436	G51838		346100	G51980		5335790	G57427	
342573	81880		345443	G51719		346101	G51980		6333406L	G57578	
342770	G64042		345447	G51703		346102	G511092		6333406R	G57577	
342778	70010		345448	G51704		346103	G511092		DG341531	58803	
342779	G63959		345450	G51729		346104	G64111		DG342476	G63866	
342780	81484		345451	G51724		346113	70086		DT341951	70040	
342781	81113		345455	G51850		346114	70053		DT346181	G64046	
342785	G64071		345456	G51841		346128	70096		DT346207	G511001	
342787	G64033		345458L	G52036		346131	70096		DT347071	77412	
342789	G64079		345458R	G52037		346178	70059		F343368	85069	89455
342790	G63886		345471	G51852		346212	70036		F343368	89455	
342791	G64050		345472	G51759		346213	G511078		F343371	85708	
342792	69465		345474	G56598		346218	G511000		F343372	83136	
342798	G63845		345478	G51832		346239	G511044		F343373	83456	89447
342799	81750		345483	G51833		346240	G51905		F343373	89447	
342827	G63622		345484	G51842		346243	G511044		F343374	85722	
342838	81676		345490	G51881		346249	G64216		F343375	85310	89423
342840	G64016		345491	G51855		346253	G511092		F343375	89423	
342841	G63892		345492	G51477		346256	G64216		F343376	85900	
342843	G64040		345555	G51891		346258	70096		F343378	85902	

**Important Note:** Competitive Interchanges are to be used for stocking purposes only. Where multiple crosses are identified, please reference the applications section of this catalog. / **Remarque importante:** Les interchanges concurrentiels ne s'utilisent qu'aux fins de stocks. Dans le cas de références multiples, consulter la section des applications du catalogue. / **Nota importante:** Dans le cas de referencias multiples, consultar la sección de aplicaciones del catálogo. / **Nota importante:** Se pueden usar intercambios competitivos para propósitos de almacenamiento solamente. Cuando se identifican intercambios múltiples, consulte la sección de aplicaciones de este catálogo.



**COMPETITIVE & O.E.M. INTERCHANGE LIST**  
**Lista de Intercambios contra Competidores y Equipo Original.**  
**Liste dinterchange de produits comptitifs & dquipement original (OEM)**

FCS... cont'd

Fcs	Gabriel	Upgrade	Fcs	Gabriel	Upgrade	Fcs	Gabriel	Upgrade	Fcs	Gabriel	Upgrade
F343379	85728		F347209	83124	89407	F347252	83002		F347308	85051	
F343380	85727		F347209	89407		F347253	83025		F347309	83122	89406
F343381	83400		F347210	83207	89407	F347254	83051		F347309	89406	
F343382	83613		F347210	89407		F347255	83035		F347310	85031	
F344342	85936	89456	F347211	85066	89448	F347256	83028		F347311	85343	
F344342	89456		F347211	89448		F347257	83031		F347312	85712	
F344343	85937		F347212	83125		F347260	85724	89443	F347313	83140	
F344344	83027		F347213	85931	89458	F347260	89443		F347314	85301	
F344345	83112		F347213	89458		F347261	85918	89449	F347314	85302	89420
F344347	83062		F347214	83048		F347261	89449		F347314	89420	
F344348	83041		F347215	85067	89451	F347262	83038		F347315	83126	89430
F344349	83045		F347215	89451		F347263	85001	89410	F347315	89430	
F344350	83050		F347216	83389	89436	F347263	89410		F347316	85303	89422
F344351	83019		F347216	85000	89436	F347264	85323	89436	F347316	89422	
F344352	85729		F347216	89436		F347264	89436		F347317	83166	
F344353	83142		F347217	83128	89436	F347265	85320	89429	F347318	85305	
F344354	83111		F347217	89436		F347265	89429		F347318	85307	
F344355	83143		F347218	83147		F347266	85003	89411	F347319	83221	
F344356	83154		F347219	85006		F347266	89411		F347319	85071	
F344357	83110		F347220	85954		F347267	83009		F347320	87015	
F344358	85026		F347221	85924	89457	F347268	85920	89503	F347321	85007	
F344360	83109		F347221	89457		F347268	89503		F347322	85334	
F346598	85033	89427	F347222	83021		F347269	85013	89414	F347323	83101	
F346598	89427		F347223	85934		F347269	89414		F347324	85338	
F346599	85311	89424	F347224	85919		F347270	85005	89430	F347325	83312	89409
F346599	89424		F347225	85958		F347270	89430		F347325	89409	
F346601	85319	89428	F347226	85012	89413	F347271	85901		F347326	85046	89434
F346601	89428		F347226	89413		F347272	85932	89453	F347326	89434	
F346603	85316	89426	F347227	85062	89408	F347272	89453		F347327	83150	
F346603	89426		F347227	89408		F347273	85047	89435	F347328	83204	
F346632	83317		F347231	83001		F347273	89435		F347329	85906	89407
F346633	85988		F347232	85959		F347274	85956		F347329	89407	
F346634	83515		F347233	85070	89459	F347275	83042		F347330	85337	
F346635	83518		F347233	89459		F347276	85923	89458	F347331	85916	89430
F346636	83395		F347234	85933	89454	F347276	89458		F347331	89430	
F346637	85649		F347234	89454		F347277	83148		F347332	85911	
F347193	85030	89440	F347235	85978		F347278	83017		F347333	83215	
F347193	89440		F347236	83137		F347279	85014		F347334	85055	89439
F347194	83203	89436	F347238	85331		F347280	85010		F347334	89439	
F347194	89436		F347239	85976		F347291	83047		F347335	85304	
F347195	85053	89442	F347241	85928		F347292	83049		F347335	85734	
F347195	89442		F347242	85957		F347293	83024		F347336	85321	
F347196	85052		F347243	83209	89414	F347294	83026		F347337	83309	
F347197	85088		F347243	89414		F347295	83011		F347339	85967	
F347198	85058	89431	F347244	85043		F347296	83006		F347340	85308	89422
F347198	89431		F347245	83029		F347297	83053		F347340	89422	
F347199	85738		F347246	83130		F347298	83044		F347341	85024	
F347200	85072		F347247	83135		F347299	83081		F347342	83169	
F347201	85064		F347248	83123	89405	F347300	85989		F347343	83905	
F347202	85045		F347248	89405		F347302	85656		F347344	83906	
F347203	83127		F347249	85084	89460	F347303	85060		F347345	85637	
F347204	83008		F347249	89460		F347304	83163		F347346	85642	
F347205	85061	89450	F347250	85300	89419	F347305	85939		F347347	83519	
F347206	85029		F347250	89419		F347306	85909		F347348	83391	
F347207	85061	89450	F347251	85023	89415	F347307	85036	89405	F347349	83363	
F347208	85938		F347251	89415		F347307	89405		F347350	85639	

**Important Note:** Competitive Interchanges are to be used for stocking purposes only. Where multiple crosses are identified, please reference the applications section of this catalog. / **Remarque importante:** Les interchanges concurrentiels ne s'utilisent qu'aux fins de stocks. Dans le cas de rfrences multiples, consulter la section des applications du catalogue. / **Nota importante:** Dans le cas de rfrences multiples, consulter la section des applications du catalogue. / **Nota importante:** Se pueden usar intercambios competitivos para propósitos de almacenamiento solamente. Cuando se identifican intercambios múltiples, consulte la sección de aplicaciones de este catálogo.

**COMPETITIVE & O.E.M. INTERCHANGE LIST**  
**Lista de Intercambios contra Competidores y Equipo Original.**  
**Liste dinterchange de produits comptitifs & dquipement original (OEM)**

**Federal Coach**

Federal coach	Gabriel	Upgrade	Federal coach	Gabriel	Upgrade	Federal coach	Gabriel	Upgrade	Federal coach	Gabriel	Upgrade
10-12388-000	85920	89503	1012388000	89503		1618708000	85724	89443	471700002991	85959	
10-12388-000	89503		1012390000	85920	89503	1618708000	89443		ASH-1136	G63623	
10-12390-000	85920	89503	1012390000	89503		471700002809	85724	89443	ASH-1154	G63622	
10-12390-000	89503		1013760000	85959		471700002809	89443		ASH1136	G63623	
10-13760-000	85959		16-18708-000	85724	89443	471700002810	85724	89443	ASH1154	G63622	
1012388000	85920	89503	16-18708-000	89443		471700002810	89443		SDA471700002991	85959	

**Fleetrite**

Fleetrite	Gabriel	Upgrade	Fleetrite	Gabriel	Upgrade	Fleetrite	Gabriel	Upgrade	Fleetrite	Gabriel	Upgrade
AMS600101	85003	89411	AMS600157	83221		AMS650139	85918	89449	AMS650436	85900	
AMS600101	89411		AMS600162	83103		AMS650139	89449		AMS650439	85732	
AMS600102	85005	89430	AMS600163	83101		AMS650400	85033	89427	AMS650440	85711	
AMS600102	89430		AMS600164	83613		AMS650400	89427		AMS650441	85704	
AMS600103	85014		AMS600166	85052		AMS650401	85013	89414	AMS650442	85700	
AMS600104	85000	89436	AMS600167	83128	89436	AMS650401	89414		AMS650444	85311	89424
AMS600104	89436		AMS600167	89436		AMS650402	85311	89424	AMS650444	89424	
AMS600106	83312	89409	AMS600168	83635		AMS650402	89424		AMS650448	85700	
AMS600106	89409		AMS600169	85051		AMS650404	85310	89423	AMS650449	85702	
AMS600107	83309		AMS600172	85005	89430	AMS650404	89423		AMS650451	85029	
AMS600108	83209	89414	AMS600172	89430		AMS650405	85023	89415	AMS650452	85733	
AMS600108	89414		AMS600173	85043		AMS650405	89415		AMS650453	85043	
AMS600110	83303		AMS600174	83125		AMS650406	85024		AMS650454	85713	
AMS600111	83301		AMS600175	83120		AMS650407	85736		AMS650455	85716	
AMS600112	83456	89447	AMS600202	83009		AMS650408	85319	89428	AMS650456	85376	
AMS600112	89447		AMS650101	85062	89408	AMS650408	89428		AMS650458	85908	
AMS600113	83215		AMS650101	89408		AMS650409	85003	89411	AMS650459	85043	
AMS600114	83125		AMS650102	85001	89410	AMS650409	89411		AMS650463	85040	
AMS600116	83216		AMS650102	89410		AMS650410	85300	89419	AMS650464	85716	
AMS600117	83308		AMS650103	85320	89429	AMS650410	89419		AMS650466	85047	89435
AMS600118	83219		AMS650103	89429		AMS650411	85036	89405	AMS650466	89435	
AMS600119	83314		AMS650105	85026		AMS650411	89405		AMS650468	85069	89455
AMS600120	G63605		AMS650107	85316	89426	AMS650412	83122	89406	AMS650468	89455	
AMS600123	G63183		AMS650107	89426		AMS650412	89406		AMS650471	85302	89420
AMS600125	83123	89405	AMS650108	85030	89440	AMS650415	85046	89434	AMS650471	89420	
AMS600125	89405		AMS650108	89440		AMS650415	89434		AMS650473	85329	
AMS600126	83400		AMS650109	85058	89431	AMS650416	85323	89436	AMS650474	85712	
AMS600128	83401		AMS650109	89431		AMS650416	89436		AMS650475	85065	
AMS600129	83317		AMS650110	85005	89430	AMS650417	85322		AMS650478	85030	89440
AMS600130	83204		AMS650110	89430		AMS650418	85906	89407	AMS650478	89440	
AMS600131	83318		AMS650111	85006		AMS650418	89407		AMS650479	83122	89406
AMS600132	83215		AMS650112	89402		AMS650419	85000	89436	AMS650479	89406	
AMS600134	83221		AMS650113	85012	89413	AMS650419	89436		AMS650480	83109	
AMS600136	85740		AMS650113	89413		AMS650420	85013	89414	AMS650480	83111	
AMS600139	85740		AMS650114	85006		AMS650420	89414		AMS650481	83123	89405
AMS600142	83209	89414	AMS650115	85027		AMS650421	85916	89430	AMS650481	89405	
AMS600142	89414		AMS650116	85303	89422	AMS650421	89430		AMS650482	85006	
AMS600145	85040		AMS650116	89422		AMS650426	85054		AMS650486	85066	89448
AMS600146	83105		AMS650118	83215		AMS650428	85321		AMS650486	89448	
AMS600147	83216		AMS650119	85029		AMS650429	85030	89440	AMS65107	85316	89426
AMS600148	85026		AMS650120	85010		AMS650429	89440		AMS65107	89426	
AMS600150	85009		AMS650121	89432		AMS650430	85712		AMS65109	85058	89431
AMS600151	85024		AMS650122	85063		AMS650431	85909		AMS65109	89431	
AMS600152	83242		AMS650123	85054		AMS650432	85910		AMS65144	85957	
AMS600153	85003	89411	AMS650124	85053	89442	AMS650433	85910		AMS65146	85648	
AMS600153	89411		AMS650124	89442		AMS650434	85012	89413	AMS65158	85954	
AMS600155	83103		AMS650128	85031		AMS650434	89413		AMS660102	85005	89430
AMS600156	83103		AMS650130	85061	89450	AMS650435	85901		AMS660102	89430	

**Important Note:** Competitive Interchanges are to be used for stocking purposes only. Where multiple crosses are identified, please reference the applications section of this catalog. / **Remarque importante:** Les interchanges concurrentiels ne s'utilisent qu'aux fins de stocks. Dans le cas de références multiples, consulter la section des applications du catalogue. / **Nota importante:** Dans le cas de referencias multiples, consultar la sección de aplicaciones del catálogo. / **Nota importante:** Se pueden usar intercambios competitivos para propósitos de almacenamiento solamente. Cuando se identifican intercambios múltiples, consulte la sección de aplicaciones de este catálogo.

# COMPETITIVE & O.E.M. INTERCHANGE LIST

## Lista de Intercambios contra Competidores y Equipo Original.

### Liste d'interchange de produits compititifs & d'equipement original (OEM)

#### Fleetrite... cont'd

Fleetrite	Gabriel	Upgrade	Fleetrite	Gabriel	Upgrade	Fleetrite	Gabriel	Upgrade	Fleetrite	Gabriel	Upgrade
AMS660103	85014		AMS660160	83114		AMS660212	83015		AMS700402	85310	89423
AMS660104	85000	89436	AMS660161	G63610		AMS660213	85009		AMS700402	89423	
AMS660104	89436		AMS660162	83103		AMS660214	83002		AMS700403	85702	
AMS660106	83312	89409	AMS660164	83613		AMS660215	85059		AMS700404	85311	89424
AMS660106	89409		AMS660166	85052		AMS660216	83123	89405	AMS700404	89424	
AMS660107	83309		AMS660167	83128	89436	AMS660216	89405		AMS700405	85300	89419
AMS660108	83209	89414	AMS660167	89436		AMS660218	83137		AMS700405	89419	
AMS660108	89414		AMS660168	83635		AMS660219	83215		AMS700406	85711	
AMS660110	83303		AMS660169	85051		AMS660220	83109		AMS700407	85712	
AMS660111	83301		AMS660170	83016		AMS660223	85055	89439	AMS700408	85704	
AMS660112	83456	89447	AMS660171	83017		AMS660223	89439		AMS700410	85314	89425
AMS660112	89447		AMS660172	83126	89430	AMS660224	83111		AMS700410	89425	
AMS660113	83215		AMS660172	89430		AMS660225	89402		AMS700413	85705	89447
AMS660114	85006		AMS660173	85043		AMS660232	83114		AMS700413	89447	
AMS660116	83216		AMS660174	83125		AMS660233	83023		AMS700414	85723	
AMS660117	83308		AMS660175	83120		AMS660234	83013		AMS700415	85318	
AMS660118	85012	89413	AMS660176	83018		AMS660236	83025		AMS700416	85709	
AMS660118	89413		AMS660177	83019		AMS660237	83005		AMS700418	85003	89411
AMS660119	83314		AMS660179	83162		AMS660238	83101		AMS700418	89411	
AMS660120	G63605		AMS660182	83004		AMS660244	83125		AMS700419	85708	
AMS660123	G63183		AMS660183	85012	89413	AMS660502	646155		AMS700420	85733	
AMS660125	83123	89405	AMS660183	89413		AMS660504	632147		AMS700421	85712	
AMS660125	89405		AMS660187	85071		AMS700101	85308	89422	AMS700422	85308	89422
AMS660126	83400		AMS660188	85045		AMS700101	89422		AMS700422	89422	
AMS660128	83401		AMS660189	83136		AMS700102	85303	89422	AMS700423	85724	89443
AMS660129	83317		AMS660190	83107		AMS700102	89422		AMS700423	89443	
AMS660130	83204		AMS660191	83216		AMS700103	85302	89420	AMS700424	85333	
AMS660131	83318		AMS660192	85001	89410	AMS700103	89420		AMS74421	85708	
AMS660132	83215		AMS660192	89410		AMS700104	85304		AMS85722	83400	
AMS660134	83221		AMS660193	83001		AMS700105	85314	89425	AMS85736	G63394	
AMS660136	85740		AMS660194	83207	89407	AMS700105	89425		AMS85768	83209	89414
AMS660142	83209	89414	AMS660194	89407		AMS700106	85301		AMS85768	89414	
AMS660142	89414		AMS660195	83130		AMS700107	85307		AMS85802	83216	
AMS660145	85040		AMS660196	G63610		AMS700108	85315		AMS85803	G63306	
AMS660146	83105		AMS660197	G63866		AMS700111	85320	89429	AMS85853	G63183	
AMS660147	83216		AMS660198	83007		AMS700111	89429		AMS85895	83207	89407
AMS660148	85026		AMS660200	83008		AMS700112	85722		AMS85895	89407	
AMS660150	G63616		AMS660201	83308		AMS700113	85736		AMS85900	G63386	
AMS660153	85003	89411	AMS660202	83009		AMS700115	85712		AMS85901	G63387	
AMS660153	89411		AMS660203	83112		AMS700116	83136		AMS85904	G63299	
AMS660155	83103		AMS660205	83003		AMS700120	85332		AMS85905	G63405	
AMS660157	85030	89440	AMS660208	G63616		AMS700121	83136		AMS85960	G63366	
AMS660157	89440		AMS660211	83110		AMS700401	85700				

#### Fleetwood

Fleetwood	Gabriel	Upgrade	Fleetwood	Gabriel	Upgrade	Fleetwood	Gabriel	Upgrade	Fleetwood	Gabriel	Upgrade
141700131809	85029		1C34-18045-AA	83209	89414	8C24-18045-DA	G63622		9U9418045AA	83209	89414
141700131810	83160		1C34-18045-AA	89414		8C24-18080-DB	G63623		9U9418045AA	89414	
16-16736-000	85029		1C34-18045-JA	83209	89414	8C2418045DA	G63622		9U9418080AA	83122	89406
16-16737-000	83160		1C34-18045-JA	89414		8C2418080DB	G63623		9U9418080AA	89406	
16-16873-000	85029		1C3418045AA	83209	89414	8C2Z-18124-D	G63622		9U9Z-18124-A	83209	89414
16-16874-000	83160		1C3418045AA	89414		8C2Z-18125-D	G63623		9U9Z-18124-A	89414	
16-18103-000	85900		1C3418045JA	83209	89414	8C2Z18124D	G63622		9U9Z-18125-A	83122	89406
1616736000	85029		1C3418045JA	89414		8C2Z18125D	G63623		9U9Z-18125-A	89406	
1616737000	83160		24-153256	85124		9U94-18045-AA	83209	89414			
1616873000	85029		24153256	85124		9U94-18045-AA	89414				
1616874000	83160		481700000490	85900		9U94-18080-AA	83122	89406			
1618103000	85900		481700000493	85900		9U94-18080-AA	89406				

**Important Note:** Competitive Interchanges are to be used for stocking purposes only. Where multiple crosses are identified, please reference the applications section of this catalog. / **Remarque importante:** Les interchanges concurrentiels ne s'utilisent qu'aux fins de stocks. Dans le cas de rferences multiples, consulter la section des applications du catalogue. / **Nota importante:** Dans le cas de rferences multiples, consultar la section des aplicaciones du catalogue. / **Nota importante:** Se pueden usar intercambios competitivos para propósitos de almacenamiento solamente. Cuando se identifican intercambios múltiples, consulte la sección de aplicaciones de este catálogo.

# COMPETITIVE & O.E.M. INTERCHANGE LIST

## Lista de Intercambios contra Competidores y Equipo Original.

### Liste d'interchange de produits compititifs & d'equipement original (OEM)

#### Fleetwood... cont'd

Fleetwood	Gabriel	Upgrade	Fleetwood	Gabriel	Upgrade	Fleetwood	Gabriel	Upgrade	Fleetwood	Gabriel	Upgrade
9U9Z18124A	83209	89414	ASH-1230	89406		ASH1162	89430		ASH294	83209	89414
9U9Z18124A	89414		ASH-137	83122	89406	ASH1205	83209	89414	ASH294	89414	
9U9Z18125A	83122	89406	ASH-137	89406		ASH1205	89414		AT-163G	G63622	
9U9Z18125A	89406		ASH-25820	85005	89430	ASH1206	83122	89406	AT-164G	G63623	
ASH-1022	83209	89414	ASH-25820	89430		ASH1206	89406		AT-620	83209	89414
ASH-1022	89414		ASH-25821	85006		ASH1228	83209	89414	AT-620	89414	
ASH-1023	83122	89406	ASH-25822	83209	89414	ASH1228	89414		AT-621	83122	89406
ASH-1023	89406		ASH-25822	89414		ASH1229	83209	89414	AT-621	89406	
ASH-1136	G63623		ASH-25823	83209	89414	ASH1229	89414		AT-766	83209	89414
ASH-1154	G63622		ASH-25823	89414		ASH1230	83122	89406	AT-766	89414	
ASH-1161	85006		ASH-25824	83122	89406	ASH1230	89406		AT163G	G63622	
ASH-1162	85005	89430	ASH-25824	89406		ASH1137	83122	89406	AT164G	G63623	
ASH-1162	89430		ASH-294	83209	89414	ASH1137	89406		AT620	83209	89414
ASH-1205	83209	89414	ASH-294	89414		ASH25820	85005	89430	AT620	89414	
ASH-1205	89414		ASH1022	83209	89414	ASH25820	89430		AT621	83122	89406
ASH-1206	83122	89406	ASH1022	89414		ASH25821	85006		AT621	89406	
ASH-1206	89406		ASH1023	83122	89406	ASH25822	83209	89414	AT766	83209	89414
ASH-1228	83209	89414	ASH1023	89406		ASH25822	89414		AT766	89414	
ASH-1228	89414		ASH1136	G63623		ASH25823	83209	89414	F4-BE5-F325-HO	85124	
ASH-1229	83209	89414	ASH1154	G63622		ASH25823	89414		F4BE5F325HO	85124	
ASH-1229	89414		ASH1161	85006		ASH25824	83122	89406	W0005663	85124	
ASH-1230	83122	89406	ASH1162	85005	89430	ASH25824	89406				

#### Fluidrive

Fluidrive	Gabriel	Upgrade	Fluidrive	Gabriel	Upgrade	Fluidrive	Gabriel	Upgrade	Fluidrive	Gabriel	Upgrade
2697	85712										

#### FLXIBLE Bus

Flxible bus	Gabriel	Upgrade	Flxible bus	Gabriel	Upgrade	Flxible bus	Gabriel	Upgrade	Flxible bus	Gabriel	Upgrade
015813	85708		6-367-11	85711		63673	85304		97-9999-00807	85307	
06-0367-00151	85700		6-367-12	85700		63676	85711		97-9999-02514	85700	
06-0367-00156	85702		6-367-14	85700		63677	85305		97-9999-02515	85702	
06036700151	85700		6-367-16	85700		63678	85700		97-9999-02632	85711	
06036700156	85702		6-367-17	85700		63679	85711		97-9999-02633	85311	89424
22012067	85700		6-367-2	85736		680029	85301		97-9999-02633	89424	
22012114	85700		6-367-3	85304		680155	85712		97-9999-02634	85733	
22024061	85704		6-367-6	85711		690029	85700		97-9999-02635	85732	
22025067	85704		6-367-7	85305		695125	85704		97-9999-02636	85716	
22025305	85704		6-367-8	85700		74412	85704		97220100151	85700	
3166657	85700		6-367-9	85711		87-2520-00001	85704		97221000001	85704	
3192333	85700		6051	85736		87-2520-00003	85704		97221000002	85704	
48-1-239	85736		60510	85734		87252000001	85704		97221000003	85704	
48-1-241	85712		60513	85304		87252000003	85704		97221000004	85704	
481239	85736		6052	85736		97-2210-00151	85700		97221000005	85704	
481241	85712		6053	85736		97-2210-00001	85704		97221000006	85704	
4975518	85704		6054	85736		97-2210-00002	85704		97221000009	85704	
6-05-1	85736		6055	85307		97-2210-00003	85704		97221000011	85704	
6-05-10	85734		6056	85736		97-2210-00004	85704		97221000156	85702	
6-05-13	85304		6057	85736		97-2210-00005	85704		97221000157	85708	
6-05-2	85736		6058	85736		97-2210-00006	85704		97221000160	85705	89447
6-05-3	85736		6059	85304		97-2210-00009	85704		97221000160	89447	
6-05-4	85736		63671	85711		97-2210-00011	85704		97221000164	85708	
6-05-5	85307		636711	85711		97-2210-00156	85702		97221000170	85733	
6-05-6	85736		636712	85700		97-2210-00157	85708		97999900807	85307	
6-05-7	85736		636714	85700		97-2210-00160	85705	89447	97999902514	85700	
6-05-8	85736		636716	85700		97-2210-00160	89447		97999902515	85702	
6-05-9	85304		636717	85700		97-2210-00164	85708		97999902632	85711	
6-367-1	85711		63672	85736		97-2210-00170	85733		97999902633	85311	89424

**Important Note:** Competitive Interchanges are to be used for stocking purposes only. Where multiple crosses are identified, please reference the applications section of this catalog. / **Remarque importante:** Les interchanges concurrentiels ne s'utilisent qu'aux fins de stocks. Dans le cas de références multiples, consulter la section des applications du catalogue. / **Nota importante:** Dans le cas de références multiples, consulter la section des applications du catalogue. / **Nota importante:** Se pueden usar intercambios competitivos para propósitos de almacenamiento solamente. Cuando se identifican intercambios múltiples, consulte la sección de aplicaciones de este catálogo.

**COMPETITIVE & O.E.M. INTERCHANGE LIST**  
**Lista de Intercambios contra Competidores y Equipo Original.**  
**Liste dinterchange de produits comptitifs & dquipement original (OEM)**

**FLXIBLE Bus... cont'd**

Flxible bus	Gabriel	Upgrade	Flxible bus	Gabriel	Upgrade	Flxible bus	Gabriel	Upgrade	Flxible bus	Gabriel	Upgrade
97999902633	89424		97999902634	85733		97999902635	85732		97999902636	85716	

**Flyer Industries**

Flyer industries	Gabriel	Upgrade	Flyer industries	Gabriel	Upgrade	Flyer industries	Gabriel	Upgrade	Flyer industries	Gabriel	Upgrade
009863	85722		22012067	85700		3192333	85700		592-6568	85700	
015915	85711		22012114	85700		4975501	85700		5926568	85700	
15813	85708		3166657	85700		4975552	85711		5979574	85700	

**Ford**

Ford	Gabriel	Upgrade	Ford	Gabriel	Upgrade	Ford	Gabriel	Upgrade	Ford	Gabriel	Upgrade
1201-0012	83023		3584118C2	85928		4790228	85013	89414	4C4Z18124AB	83163	
1201-1043	83025		3919942	89402		4790228	89414		4C4Z18124BB	83135	
1201-1044	83025		3L2Z 18124-CA	G57017		479028	83122	89406	4C4Z18124CB	85957	
12010012	83023		3U2Z 18124-BJ	G57080		479028	89406		4C4Z18124DC	85927	
12011043	83025		3U2Z 18124-BK	G57080		4C4O-18045-AA	83163		4C4Z18124EA	85656	
12011044	83025		3U2Z 18124-PAA	G57017		4C4O-18045-BB	83135		4C4Z18124GB	83175	
1202-0012	83023		3U2Z-18124-BAA	G63809		4C4O-18045-CA	85957		4C4Z18124HB	83135	
1202-0032	83016		3U2Z-18124-BV	G63614		4C4O-18045-DB	85927		4C4Z18124JB	85928	
1202-0042	83025		3U2Z-18124-BW	G63614		4C4O-18045-EA	85656		4C4Z18124KA	85976	
1202-1043	83025		3U2Z-18124-EA	G63772		4C4O-18045-GA	83175		4C4Z18124LA	85976	
1202-1044	83025		3U2Z-18124-FA	G63608		4C4O-18045-HA	83135		4C4Z18124M	85656	
12020012	83023		3U2Z-18124-FAA	G63809		4C4O-18045-JA	85928		4C4Z18124P	83135	
12020032	83016		3U2Z-18124-JAA	G63614		4C4O-18045-KA	85976		4C4Z18124QA	83175	
12020042	83025		3U2Z-18124-MAA	83131		4C4O-18045-LA	85976		4C4Z18124RA	85928	
12021043	83025		3U2Z-18124-YAA	G63809		4C4O-18045-MA	85656		4C4Z18125AB	83101	
12021044	83025		3U2Z-18125-AD	69575		4C4O-18080-AA	83101		4C4Z18125B	83317	
1605788	G64063		3U2Z-18125-CA	G63607		4C4O-18080-BA	83317		4C4Z18125CA	85976	
1C34-18045-AA	83209	89414	3U2Z-18125-DA	G63525		4C4O18045AA	83163		4C4Z18125DA	85656	
1C34-18045-AA	89414		3U2Z-18125-EA	G63524		4C4O18045BB	83135		4U2Z-18V124-AA	G63678	
1C34-18045-JA	83209	89414	3U2Z-18125-RA	G63623		4C4O18045CA	85957		50U2Z18V124AA	G63678	
1C34-18045-JA	89414		3U2Z18124BAA	G63809		4C4O18045DB	85927		501906C91	83317	
1C3418045AA	83209	89414	3U2Z18124BV	G63614		4C4O18045EA	85656		501906C92	83317	
1C3418045AA	89414		3U2Z18124BW	G63614		4C4O18045GA	83175		57241-2	83109	
1C3418045JA	83209	89414	3U2Z18124EA	G63772		4C4O18045HA	83135		572412	83109	
1C3418045JA	89414		3U2Z18124FA	G63608		4C4O18045JA	85928		57365-111	85006	
1C44-18080-AA	83123	89405	3U2Z18124FAA	G63809		4C4O18045KA	85976		57365111	85006	
1C44-18080-AA	89405		3U2Z18124JAA	G63614		4C4O18045LA	85976		5C3Z-18124-JA	G63969	
1C4418080AA	83123	89405	3U2Z18124MAA	83131		4C4O18045MA	85656		5C3Z-18125-CF	77969	
1C4418080AA	89405		3U2Z18124YAA	G63809		4C4O18080AA	83101		5C3Z-18125-DA	77968	
2C44-18045-BA	83175		3U2Z18125AD	69575		4C4O18080BA	83317		5C3Z18124JA	G63969	
2C4418045BA	83175		3U2Z18125CA	G63607		4C4Z-18124-AB	83163		5C3Z18125CF	77969	
2C4Z-18124-BA	83175		3U2Z18125DA	G63525		4C4Z-18124-BB	83135		5C3Z18125DA	77968	
2C4Z18124BA	83175		3U2Z18125EA	G63524		4C4Z-18124-CB	85957		5L1Z 18125-A	G57016	
2C7Z-18125-AA	G63837		3U2Z18125RA	G63623		4C4Z-18124-DC	85927		5L2Z 18124-CA	G57018	
2C7Z-18125-CA	G63607		47 1700 007 203	85013	89414	4C4Z-18124-EA	85656		5L2Z 18124-CB	G57019	
2C7Z18125AA	G63837		47 1700 007 203	89414		4C4Z-18124-GB	83175		5L3Z-18125-AA	G63867	
2C7Z18125CA	G63607		471700007117	85010		4C4Z-18124-HB	83135		5U2Z-18V124-AA	G63714	
2F2Z 18124-AA	G56935		471700009775	85010		4C4Z-18124-JB	85928		5U2Z-18V124-AHA	G63622	
2L1Z 18124-AD	G57015		471700011530	85181		4C4Z-18124-KA	85976		5U2Z-18V124-AU	G63772	
2L7Z 18125-AA	G57016		471700011531	85180		4C4Z-18124-LA	85976		5U2Z-18V124-BA	G63716	
3199942	89402		47902-13	83122	89406	4C4Z-18124-M	85656		5U2Z-18V124-CAA	G63809	
3553628C1	85927		47902-13	89406		4C4Z-18124-P	83135		5U2Z-18V124-DB	G63455	
3553628C2	85927		47902-28	85013	89414	4C4Z-18124-QA	83175		5U2Z-18V124-GA	G63809	
3578858C1	85656		47902-28	89414		4C4Z-18124-RA	85928		5U2Z-18V124-LA	G63929	
3578858C2	85656		47902-8	83122	89406	4C4Z-18125-AB	83101		5U2Z-18V125-AE	G63808	
3584116C1	83175		47902-8	89406		4C4Z-18125-B	83317		5U2Z-18V125-AF	G63810	
3584116C2	83175		4790213	83122	89406	4C4Z-18125-CA	85976		5U2Z-18V125-BDA	G63623	
3584117C2	83135		4790213	89406		4C4Z-18125-DA	85656		5U2Z-18V125-BGA	G63778	

**Important Note:** Competitive Interchanges are to be used for stocking purposes only. Where multiple crosses are identified, please reference the applications section of this catalog. / **Remarque importante:** Les interchanges concurrentiels ne s'utilisent qu'aux fins de stocks. Dans le cas de rfrnces multiples, consulter la section des applications du catalogue. / **Nota importante:** Dans le cas de rfrnces multiples, consultar la section des aplicaciones du catalogue. / **Nota importante:** Se pueden usar intercambios competitivos para propósitos de almacenamiento solamente. Cuando se identifican intercambios múltiples, consulte la sección de aplicaciones de este catálogo.

**COMPETITIVE & O.E.M. INTERCHANGE LIST**  
**Lista de Intercambios contra Competidores y Equipo Original.**  
**Liste dinterchange de produits comptitifs & dquipement original (OEM)**

**Ford... cont'd**

Ford	Gabriel	Upgrade	Ford	Gabriel	Upgrade	Ford	Gabriel	Upgrade	Ford	Gabriel	Upgrade
5U2Z-18V125-BS	G63607		6L1Z 18125-AA	G57016		8C2Z18125D	G63623		AE5Z 18124-A	G57427	
5U2Z-18V125-BT	G63525		6L1Z 18125-AB	G57016		8C3Z-3E651-E	14072		AE5Z 18124-B	G57427	
5U2Z-18V125-BU	G63524		6L7Z 18124-BC	G57015		8L1Z 18125-B	G57173		AE5Z 18124-C	G57427	
5U2Z-18V125-F	G63676		6U2Z-18V125-A	G63837		8L1Z 18125-C	G57173		AE5Z 18124-D	G57427	
5U2Z-18V125-G	G63837		6U2Z-18V125-B	G63607		8L1Z 18125-H	G57173		AE5Z 18124-E	G57427	
5U2Z-18V125-VG	69845		6U2Z18V125A	G63837		8L1Z 18125-J	G57173		AE5Z 18124-F	G57427	
5U2Z-3V651-C	6828SE		6U2Z18V125B	G63607		90044769	83207	89407	AE5Z 18124-J	G57427	
5U2Z18V124AA	G63714		70127	85006		90044769	89407		AE5Z 18124-K	G57427	
5U2Z18V124AHA	G63622		70128	85006		90044770	83207	89407	AE5Z 18125-A	69591	
5U2Z18V124AU	G63772		7C2Z-18125-D	G63623		90044770	89407		AE5Z 18125-B	69591	
5U2Z18V124BA	G63716		7C34-18045-HB	G63969		90045099	85906	89407	AE5Z 18125-C	69591	
5U2Z18V124CAA	G63809		7C34-18080-DCB	77968		90045099	89407		AE5Z 18125-G	69591	
5U2Z18V124DB	G63455		7C3418045HB	G63969		90045132	85906	89407	AG1Z 18124-A	G57498	
5U2Z18V124GA	G63809		7C3418080DCB	77968		90045132	85909		AG1Z 18124-B	G57497	
5U2Z18V124LA	G63929		7C3Z 18124-NCA	G63886		90045132	89407		AG1Z 18124-C	G57498	
5U2Z18V125AE	G63808		7C3Z 18124-NDA	G63886		9C3Z 18124-A	G63886		AG1Z 18124-D	G57497	
5U2Z18V125AF	G63810		7C3Z 18124-NEA	G63886		9C3Z 18125-A	G63888		AG1Z 18124-E	G57498	
5U2Z18V125BDA	G63623		7C3Z 18124-PBA	G63886		9L8Z 18124-AL	G56601		AG1Z 18124-F	G57497	
5U2Z18V125BGA	G63778		7C3Z 18124-PCA	G63886		9L8Z 18124-AR	G56568		AG1Z 18124-G	G57497	
5U2Z18V125BS	G63607		7C3Z 18125-JCA	G63888		9L8Z 18124-BL	G56601		AG1Z 18124-H	G57498	
5U2Z18V125BT	G63525		7C3Z 18125-JEA	G63888		9L8Z 18124-BR	G56568		AH6Z 18124-D	G51896	
5U2Z18V125BU	G63524		7C3Z 18125-KBA	G63888		9R3Z 18124-G	G57271		AH6Z-18124-C	G51897	
5U2Z18V125F	G63676		7C3Z 18125-KCA	G63888		9U94-18045-AA	83209	89414	AL1Z 18124-D	G51860	
5U2Z18V125G	G63837		7C3Z 18125-KDA	G63888		9U94-18045-AA	89414		AL1Z 18125-A	G57173	
60670-008	83123	89405	7C3Z-18124-NJA	G63886		9U94-18080-AA	83122	89406	AL1Z 18125-D	G51861	
60670-008	89405		7C3Z-18125-CXA	G64010		9U94-18080-AA	89406		AL1Z 18125-F	G51861	
60670-008L	83123	89405	7E5Z 18124-LH	G57148		9U9418045AA	83209	89414	AL3Z 18124-BA	G51865	
60670-008L	89405		7E5Z 18124-RH	G57148		9U9418045AA	89414		AL3Z 18124-DA	G57103	
60670-011	83148		7L2Z 18124-AC	G57095		9U9418080AA	83122	89406	AL3Z 18124-EA	G57103	
60670-012	83168		7L2Z 18124-BB	G57095		9U9418080AA	89406		AL3Z 18124-GA	G51864	
60670008	83123	89405	7L5Z-18124-A	G63772		9U9Z-18124-A	83209	89414	AL3Z 18124-RB	G51865	
60670008	89405		7W7Z-18125-B	69574		9U9Z-18124-A	89414		AL3Z 18124-SB	G57103	
60670008L	83123	89405	7W7Z18125B	69574		9U9Z-18125-A	83122	89406	AL3Z 18125-E	G64157	
60670008L	89405		87HU-18045-AA	85301		9U9Z-18125-A	89406		AL3Z 18125-G	G64079	
60670011	83148		87HU18045AA	85301		9U9Z-18125-B	83122	89406	AL3Z 18125-H	G64079	
60670012	83168		8A4Z 18183-C	143415		9U9Z-18125-B	89406		AL3Z 18125-K	G64157	
60675-003	85976		8A8Z 18125-E	G51996		9U9Z18124A	83209	89414	AL3Z 18125-L	G64079	
60675-003L	85976		8C24-18045-DA	G63622		9U9Z18124A	89414		AL3Z-18124-AA	G51865	
60675-014	85978		8C24-18080-DB	G63623		9U9Z18124B	83209	89414	AL3Z-18125-D	G64157	
60675003	85976		8C2418045DA	G63622		9U9Z18124B	89414		ALK3Z 18124-GA	G57103	
60675003L	85976		8C24 18045DA	G63625		9U9Z18125A	83122	89406	ASH-1022	83209	89414
60675014	85978		8C2418080DB	G63623		9U9Z18125A	89406		ASH-1022	89414	
680029	85301		8C2Z 18124-B	G63622		9U9Z18125B	83122	89406	ASH-1023	83122	89406
6C2Z-18124-A	G63622		8C2Z 18124-C	G63622		9U9Z18125B	89406		ASH-1023	89406	
6C2Z-18124-B	G63929		8C2Z 18125-D	G63623		AA-494	83131		ASH-1105	85976	
6C2Z18124B	G63929		8C2Z-18124-A	G63622		AA-615	83135		ASH-1136	G63623	
6E5Z 18124-BL	G51859		8C2Z-18124-D	G63622		AA-616	83175		ASH-1154	G63622	
6E5Z-18124-BR	G51859		8C2Z-18125-A	G63623		AA-617	85928		ASH-1161	85006	
6E5Z-18125-BA	69591		8C2Z-18125-B	G63623		AA-619	85927		ASH-1162	85005	89430
6E7O-18B038-AA	83364		8C2Z-18125-C	G63623		AA-620	83101		ASH-1162	89430	
6E7O18B038AA	83364		8C2Z-18125-D	G63623		AA494	83131		ASH-1205	83209	89414
6E7Z-18124-AB	83364		8C2Z18124D	G63622		AA615	83135		ASH-1205	89414	
6E7Z18124AB	83364		8C2Z18124D	G63624		AA616	83175		ASH-1206	83122	89406
6ETZ-18125-A	83364		8C2Z18125A	G63623		AA617	85928		ASH-1206	89406	
6ETZ18125A	83364		8C2Z18125B	G63623		AA619	85927		ASH-12251	85013	89414
6L1Z 18124-DD	G57015		8C2Z18125C	G63623		AA620	83101		ASH-12251	89414	

**Important Note:** Competitive Interchanges are to be used for stocking purposes only. Where multiple crosses are identified, please reference the applications section of this catalog. / **Remarque importante:** Les interchanges concurrentiels ne s'utilisent qu'aux fins de stocks. Dans le cas de rferences multiples, consulter la section des applications du catalogue. / **Nota importante:** Dans le cas de rferences multiples, consulter la section des applications du catalogue. / **Nota importante:** Se pueden usar intercambios competitivos para propósitos de almacenamiento solamente. Cuando se identifican intercambios múltiples, consulte la sección de aplicaciones de este catálogo.



**COMPETITIVE & O.E.M. INTERCHANGE LIST**  
**Lista de Intercambios contra Competidores y Equipo Original.**  
**Liste d'interchange de produits compititifs & d'equipement original (OEM)**

**Ford... cont'd**

Ford	Gabriel	Upgrade	Ford	Gabriel	Upgrade	Ford	Gabriel	Upgrade	Ford	Gabriel	Upgrade
ASH-12261	85010		ASH1154	G63622		AT-611	G63461		B8QZ18124A	83312	89409
ASH-1228	83209	89414	ASH1161	85006		AT-620	83209	89414	B8QZ18124A	89409	
ASH-1228	89414		ASH1162	85005	89430	AT-620	89414		B8TZ-18124-A	83219	
ASH-1229	83209	89414	ASH1162	89430		AT-621	83122	89406	B8TZ18124A	83219	
ASH-1229	89414		ASH1205	83209	89414	AT-621	89406		B9TT-18045-C	83219	
ASH-1230	83122	89406	ASH1205	89414		AT-696	83140		B9TT-18045-D	83219	
ASH-1230	89406		ASH1206	83122	89406	AT-766	83209	89414	B9TT18045C	83219	
ASH-137	83122	89406	ASH1206	89406		AT-766	89414		B9TT18045D	83219	
ASH-137	89406		ASH12251	85013	89414	AT-811	83135		BC3Z 18124-AA	G63886	
ASH-23486	G63461		ASH12251	89414		AT-812	85928		BC3Z 18124-B	G63622	
ASH-23488	G63461		ASH12261	85010		AT163G	G63622		BC3Z 18124-C	G63622	
ASH-24446	83215		ASH1228	83209	89414	AT163G	G63623		BC3Z 18124-K	G63886	
ASH-2447	83140		ASH1228	89414		AT164G	G63623		BC3Z 18124-M	G63886	
ASH-24473	85013	89414	ASH1229	83209	89414	AT504G	G63679		BC3Z 18124-N	G63886	
ASH-24473	89414		ASH1229	89414		AT610	G63461		BC3Z 18124-R	G63886	
ASH-24474	85010		ASH1230	83122	89406	AT611	G63461		BC3Z 18124-T	G63886	
ASH-24522	85013	89414	ASH1230	89406		AT620	83209	89414	BC3Z 18124-U	G63886	
ASH-24522	89414		ASH137	83122	89406	AT620	89414		BC3Z 18124-X	G63886	
ASH-24523	85010		ASH137	89406		AT621	83122	89406	BC3Z 18124-Y	G63886	
ASH-24589	85010		ASH23486	G63461		AT621	89406		BC3Z 18124-Z	G63886	
ASH-24634	85013	89414	ASH23488	G63461		AT696	83140		BC3Z 18125-A	G64010	
ASH-24634	89414		ASH24446	83215		AT766	83209	89414	BC3Z 18125-AE	G63888	
ASH-24658	85181		ASH2447	83140		AT766	89414		BC3Z 18125-AF	G63888	
ASH-24659	85181		ASH24473	85013	89414	AT811	83135		BC3Z 18125-AL	G63888	
ASH-24660	85180		ASH24473	89414		AT812	85928		BC3Z 18125-B	G64010	
ASH-24661	83317		ASH24474	85010		AU2Z 18124-H	G57015		BC3Z 18125-J	G63888	
ASH-24662	83168		ASH24522	85013	89414	AU2Z 18125-E	G57016		BC3Z 18125-L	G63888	
ASH-24663	83148		ASH24522	89414		AU2Z-18V124-AC	G63886		BC3Z 18125-M	G63888	
ASH-247	G63461		ASH24589	85010		AU2Z-18V124-AU	G63622		BC3Z 18125-N	G63888	
ASH-25770	77987		ASH24634	85013	89414	AU2Z-18V124-AY	G63714		BC3Z 18125-R	G63888	
ASH-25820	85005	89430	ASH24634	89414		AU2Z-18V124-BB	G63714		BC3Z-18124-A	G63622	
ASH-25820	89430		ASH24658	85181		AU2Z-18V124-BH	G63716		BC3Z-18124-AB	G63886	
ASH-25821	85006		ASH24659	85181		AU2Z-18V124-J	G63886		BC3Z-18124-AC	77967	
ASH-25822	83209	89414	ASH24660	85180		AU2Z-18V125-BD	G63715		BC3Z-18124-F	G63886	
ASH-25822	89414		ASH24661	83317		AU2Z-18V125-S	G63888		BC3Z-18124-G	G63886	
ASH-25823	83209	89414	ASH24662	83168		AX-267A	83309		BC3Z-18125-AA	G64010	
ASH-25823	89414		ASH24663	83148		AX-310	83215		BC3Z-18125-AJ	G63888	
ASH-25824	83122	89406	ASH247	G63461		AX267A	83309		BC3Z-18125-AN	G64010	
ASH-25824	89406		ASH25820	85005	89430	AX310	83215		BC3Z-18125-AP	77969	
ASH-25838	85978		ASH25820	89430		AX85A	83219		BC3Z-18125-AQ	77969	
ASH-294	83209	89414	ASH25821	85006		B3Q-18124-A	83219		BC3Z-18125-F	61682	
ASH-294	89414		ASH25822	83209	89414	B3Q18124A	83219		BC3Z-18125-V	G63888	
ASH-397	83131		ASH25822	89414		B6TZ-18124-A	83219		BE8Z 18124-A	G52256	
ASH-722	85976		ASH25823	83209	89414	B6TZ18124A	83219		BE8Z 18124-B	G52255	
ASH-85789	77986		ASH25823	89414		B7T-18124-C	83225		BE8Z 18124-C	G52256	
ASH-85856	77987		ASH25824	83122	89406	B7T18124C	83225		BE8Z 18124-D	G52255	
ASH-85857	77987		ASH25824	89406		B7TZ-18124-B	83216		BE8Z 18125-A	70052	
ASH-85927	77986		ASH25838	85978		B7TZ-18124-C	83216		BE8Z 18125-B	70052	
ASH-866127	77986		ASH294	83209	89414	B7TZ-18124-D	83219		BK3Z-18124-A	G57816	
ASH-866139	77986		ASH294	89414		B7TZ18124B	83216		BL3Z 18124-C	G51865	
ASH1022	83209	89414	ASH397	83131		B7TZ18124C	83216		BL3Z 18124-F	G57103	
ASH1022	89414		ASH722	85976		B7TZ18124D	83219		BL3Z 18125-C	G64157	
ASH1023	83122	89406	AT-163G	G63622		B8Q-18125-A	85307		BL3Z 18125-F	G64079	
ASH1023	89406		AT-164G	G63623		B8Q18125A	85307		BT4Z 18124-C	G52351	
ASH1105	85976		AT-504G	G63679		B8QZ-18124-A	83312	89409	BT4Z 18124-D	G52352	
ASH1136	G63623		AT-610	G63461		B8QZ-18124-A	89409		BT4Z 18124-E	G52352	

**Important Note:** Competitive Interchanges are to be used for stocking purposes only. Where multiple crosses are identified, please reference the applications section of this catalog. / **Remarque importante:** Les interchanges concurrentiels ne s'utilisent qu'aux fins de stocks. Dans le cas de rferences multiples, consulter la section des applications du catalogue. / **Nota importante:** Dans le cas de rferences multiples, consultar la section des aplicaciones du catalogue. / **Nota importante:** Se pueden usar intercambios competitivos para propósitos de almacenamiento solamente. Cuando se identifican intercambios múltiples, consulte la sección de aplicaciones de este catálogo.

**COMPETITIVE & O.E.M. INTERCHANGE LIST**  
**Lista de Intercambios contra Competidores y Equipo Original.**  
**Liste dinterchange de produits comptitifs & dquipement original (OEM)**

**Ford... cont'd**

Ford	Gabriel	Upgrade	Ford	Gabriel	Upgrade	Ford	Gabriel	Upgrade	Ford	Gabriel	Upgrade
BT4Z 18124-EC	G52351		C1TZ18124N	83314		C6TA-18045-Z	85301		D0HA18045D	83309	
BU2Z-18V124-E	83107		C1TZ18124P	83312	89409	C6TA18045U	85301		D0HA18045E	83312	89409
BU2Z-18V125-F	G64010		C1TZ18124P	89409		C6TA18045V	85301		D0HA18045E	89409	
BU2Z18V124E	83107		C2TA-18045-A	83216		C6TA18045Y	85301		D0HZ-18124-A	83309	
BU2Z18V125P	G63778		C2TA-18045-B	83308		C6TA18045Z	85301		D0HZ-18124-B	83312	89409
BU9Z-18124-A	85013	89414	C2TA18045A	83216		C6TZ-18124-D	85301		D0HZ-18124-B	89409	
BU9Z-18124-A	89414		C2TA18045B	83308		C6TZ-18124-E	85301		D0HZ-18124-C	83314	
BU9Z-18125-A	85010		C2TZ-18124-A	83308		C6TZ-18124-H	85301		D0HZ18124A	83309	
BU9Z18124A	85013	89414	C2TZ18124A	83308		C6TZ-18124-J	85301		D0HZ18124B	83312	89409
BU9Z18124A	89414		C3TA-18045-A	83216		C6TZ18124D	85301		D0HZ18124B	89409	
BU9Z18125A	85010		C3TA18045A	83216		C6TZ18124E	85301		D0HZ18124C	83314	
BV6Z 18125-B	G511002		C3TZ-18124-A	83308		C6TZ18124H	85301		D1TF-18045-LA	83312	89409
BV6Z 18125-C	G511002		C3TZ18124A	83308		C6TZ18124J	85301		D1TF-18045-LA	89409	
BV6Z 18125-D	G511002		C4HZ-18124-A	83312	89409	C7HZ-18124-A	83312	89409	D1TF18045LA	83312	89409
BV6Z 18125-E	G511002		C4HZ-18124-A	89409		C7HZ-18124-A	89409		D1TF18045LA	89409	
BV6Z 18125-F	G511002		C4HZ-18124-B	83309		C7HZ18124A	83312	89409	D1TZ-18124-D	83308	
BV6Z 18125-G	G511002		C4HZ-18124-C	83314		C7HZ18124A	89409		D1TZ-18124-E	83216	
C0TT-18045-A	83219		C4HZ-18124-D	83312	89409	C7PF-18077-A	83225		D1TZ-18124-F	83312	89409
C0TT-18045-D	83216		C4HZ-18124-D	89409		C7PF18077A	83225		D1TZ-18124-F	89409	
C0TT18045A	83219		C4HZ-18124-E	83309		C7TA-18045-R	83216		D1TZ18124D	83308	
C0TT18045D	83216		C4HZ-18124-F	83308		C7TA-18045-Z	85301		D1TZ18124E	83216	
C0TZ-18124-A	83216		C4HZ18124A	83312	89409	C7TA18045R	83216		D1TZ18124F	83312	89409
C0TZ18124A	83216		C4HZ18124A	89409		C7TA18045Z	85301		D1TZ18124F	89409	
C1BZ 18124-B	G52255		C4HZ18124B	83309		C8HA-18045-A	83312	89409	D2EF-18045-AA	83312	89409
C1BZ 18124-E	G52256		C4HZ18124C	83314		C8HA-18045-A	89409		D2EF-18045-AA	89409	
C1TT-18045-C	83312	89409	C4HZ18124D	83312	89409	C8HA18045A	83312	89409	D2EF-18124-AA	83312	89409
C1TT-18045-C	89409		C4HZ18124D	89409		C8HA18045A	89409		D2EF-18124-AA	89409	
C1TT-18045-E	83314		C4HZ18124E	83309		C8PF18045CM	83216		D2EF18045AA	83312	89409
C1TT-18045-G	83216		C4HZ18124F	83308		C8PF18045CM	83216		D2EF18045AA	89409	
C1TT18045C	83312	89409	C4PF-18045-H	83216		C8TA-18045-AA	G63386		D2EF18124AA	83312	89409
C1TT18045C	89409		C4PF18045H	83216		C8TA18045AA	G63386		D2EF18124AA	89409	
C1TT18045E	83314		C4TZ-18124-AA	83308		CA8Z 18125-A	G51996		D2HA-18045-E1A	85304	
C1TT18045G	83216		C4TZ-18124-AB	83308		CA8Z 18125-B	G51996		D2HA-18045-E1B	85304	
C1TZ-18045-C	83312	89409	C4TZ-18124-B	83308		CG1Z 18125-A	70096		D2HA-18045-E2A	85304	
C1TZ-18045-C	89409		C4TZ18124AA	83308		CG1Z 18125-B	70096		D2HA-18045-E2B	85304	
C1TZ-18124-B	83216		C4TZ18124AB	83308		CG1Z 18125-C	70096		D2HA-18045-EB	85301	
C1TZ-18124-C	83312	89409	C4TZ18124B	83308		CG1Z 18125-D	70096		D2HA-18045-F1A	85301	
C1TZ-18124-C	89409		C5TZ-18124-A	83308		CK4Z-18124-E	G57816		D2HA-18045-F1B	85301	
C1TZ-18124-D	83309		C5TZ18124A	83308		CL3Z 18124-B	G57103		D2HA-18045-F2A	85301	
C1TZ-18124-E	83312	89409	C6PF-18077-A	G63306		CL8Z 18125-A	G64047		D2HA-18045-F2B	85301	
C1TZ-18124-E	89409		C6PF-18077-DD	83216		CL8Z 18125-B	G64047		D2HA18045E1A	85304	
C1TZ-18124-F	83312	89409	C6PF-18077-DE	83219		CL8Z 18125-C	G64047		D2HA18045E1B	85304	
C1TZ-18124-F	89409		C6PF-18077-DL	83312	89409	CT4Z 18124-A	G52351		D2HA18045E2A	85304	
C1TZ-18124-N	83314		C6PF-18077-DL	89409		CT4Z 18124-B	G52352		D2HA18045E2B	85304	
C1TZ-18124-P	83312	89409	C6PF-18077-DN	83314		CT4Z 18125-A	G64111		D2HA18045EB	85301	
C1TZ-18124-P	89409		C6PF-18077-F	83225		CU9Z-18124-A	85013	89414	D2HA18045F1A	85301	
C1TZ18045C	83312	89409	C6PF18077A	G63306		CU9Z-18124-A	89414		D2HA18045F1B	85301	
C1TZ18045C	89409		C6PF18077DD	83216		CU9Z-18125-A	85010		D2HA18045F2A	85301	
C1TZ18124B	83216		C6PF18077DE	83219		CU9Z18124A	85013	89414	D2HA18045F2B	85301	
C1TZ18124C	83312	89409	C6PF18077DL	83312	89409	CU9Z18124A	89414		D2HF-18045-A	83314	
C1TZ18124C	89409		C6PF18077DL	89409		CU9Z18125A	85010		D2HF-18045-AA	83314	
C1TZ18124D	83309		C6PF18077DN	83314		CV6Z 18125-P	G511001		D2HF-18045-BA	83309	
C1TZ18124E	83312	89409	C6PF18077F	83225		CV6Z 18125-Q	G511001		D2HF-18045-CA	83308	
C1TZ18124E	89409		C6TA-18045-U	85301		D0HA-18045-D	83309		D2HF-18045-DA	83312	89409
C1TZ18124F	83312	89409	C6TA-18045-V	85301		D0HA-18045-E	83312	89409	D2HF-18045-DA	89409	
C1TZ18124F	89409		C6TA-18045-Y	85301		D0HA-18045-E	89409		D2HF-18124-AA	83314	

**Important Note:** Competitive Interchanges are to be used for stocking purposes only. Where multiple crosses are identified, please reference the applications section of this catalog. / **Remarque importante:** Les interchanges concurrentiels ne s'utilisent qu'aux fins de stocks. Dans le cas de rferences multiples, consulter la section des applications du catalogue. / **Nota importante:** Dans le cas de rferences multiples, consulter la section des applications du catalogue. / **Nota importante:** Se pueden usar intercambios competitivos para propósitos de almacenamiento solamente. Cuando se identifican intercambios múltiples, consulte la sección de aplicaciones de este catálogo.

**COMPETITIVE & O.E.M. INTERCHANGE LIST**  
**Lista de Intercambios contra Competidores y Equipo Original.**  
**Liste dinterchange de produits comptitifs & dquipement original (OEM)**

**Ford... cont'd**

Ford	Gabriel	Upgrade	Ford	Gabriel	Upgrade	Ford	Gabriel	Upgrade	Ford	Gabriel	Upgrade
D2HF18045A	83314		D2TZ-18124-E	83312	89409	D7HT-18045-EA	89409		D7TA-18124-GA	83314	
D2HF18045AA	83314		D2TZ-18124-E	89409		D7HT-18045-GA	83308		D7TA18124GA	83314	
D2HF18045BA	83309		D2TZ-18124-F	83309		D7HT-18045-HA	85012	89413	D8HZ-18124-A	85301	
D2HF18045CA	83308		D2TZ-18124-G	83314		D7HT-18045-HA	89413		D8HZ-18125-A	83209	89414
D2HF18045DA	83312	89409	D2TZ-18124-H	83308		D7HT-18045-JA	83308		D8HZ-18125-A	89414	
D2HF18045DA	89409		D2TZ-18124-J	83312	89409	D7HT-18045-NA	85301		D8HZ-18125-B	83123	89405
D2HF18124AA	83314		D2TZ-18124-J	89409		D7HT-18080-BA	83225		D8HZ-18125-B	89405	
D2HT-18045-CA	83314		D2TZ18124A	83308		D7HT-18080-CA	83225		D8HZ18124A	85301	
D2HT-18045-EA	83312	89409	D2TZ18124E	83312	89409	D7HT-18080-DA	83215		D8HZ18125A	83209	89414
D2HT-18045-EA	89409		D2TZ18124E	89409		D7HT-18124-BA	83312	89409	D8HZ18125A	89414	
D2HT-18045-GA	83308		D2TZ18124F	83309		D7HT-18124-BA	89409		D8HZ18125B	83123	89405
D2HT-18080-HA	83225		D2TZ18124G	83314		D7HT-18124-CA	83314		D8HZ18125B	89405	
D2HT18045CA	83314		D2TZ18124H	83308		D7HT-18124-DA	83309		DA8Z 18125-A	G51996	
D2HT18045EA	83312	89409	D2TZ18124J	83312	89409	D7HT-18124-EA	83312	89409	DA8Z 18125-B	G51996	
D2HT18045EA	89409		D2TZ18124J	89409		D7HT-18124-EA	89409		DB5Z 18125-E	G51980	
D2HT18045GA	83308		D3TA-18045-BA	83219		D7HT-18124-FA	83312	89409	DB5Z 18125-F	G51980	
D2HT18080HA	83225		D3TA18045BA	83219		D7HT-18124-FA	89409		DB5Z 18125-H	G51980	
D2HZ-18080-A	83209	89414	D3TZ-18124-B	83219		D7HT-18124-GA	83308		DB5Z-18125-G	G51980	
D2HZ-18080-A	89414		D3TZ18124B	83219		D7HT-18124-HA	83219		DG1Z 18124-AA	G57812	
D2HZ-18125-A	83209	89414	D4HA-18080-A	83209	89414	D7HT-18124-JA	83308		DG1Z 18125-A	70096	
D2HZ-18125-A	89414		D4HA-18080-A	89414		D7HT-18124-KA	85301		DG1Z 18125-F	70096	
D2HZ-18125-B	83209	89414	D4HA-18080-AA	83209	89414	D7HT-18125-DA	83215		DG9Z 18124-AB	G57812	
D2HZ-18125-B	89414		D4HA-18080-AA	89414		D7HT-18125-FA	83123	89405	DG9Z 18124-P	G57812	
D2HZ18080A	83209	89414	D4HA18080A	83209	89414	D7HT-18125-FA	89405		DG9Z 18124-Q	G57812	
D2HZ18080A	89414		D4HA18080A	89414		D7HT18045BA	83312	89409	DG9Z 18124-T	G57812	
D2HZ18125A	83209	89414	D4HA18080AA	83209	89414	D7HT18045BA	89409		DG9Z 18124-Y	G57812	
D2HZ18125A	89414		D4HA18080AA	89414		D7HT18045CA	83314		DG9Z 18124-Z	G57812	
D2HZ18125B	83209	89414	D4TF-18045-AA	83312	89409	D7HT18045DA	83309		DG9Z 18125-K	G51965	
D2HZ18125B	89414		D4TF-18045-AA	89409		D7HT18045EA	83312	89409	DG9Z 18125-Q	G51965	
D2KF-18045-AA	83312	89409	D4TF18045AA	83312	89409	D7HT18045EA	89409		DG9Z 18125-S	G51965	
D2KF-18045-AA	89409		D4TF18045AA	89409		D7HT18045GA	83308		DG9Z 18125-T	G51965	
D2KF-18124-AA	83312	89409	D4TZ-18124-J	83308		D7HT18045JA	83308		DG9Z-18125-U	G51965	
D2KF-18124-AA	89409		D4TZ18124J	83308		D7HT18045NA	85301		DU94-18045-CB	85013	89414
D2KF18045AA	83312	89409	D5TZ-18124-B	83308		D7HT18080BA	83225		DU94-18045-CB	89414	
D2KF18045AA	89409		D5TZ-18124-C	83312	89409	D7HT18080DA	83215		DU94-18080-CA	85010	
D2KF18124AA	83312	89409	D5TZ-18124-C	89409		D7HT18124BA	83312	89409	DU94-18080-CB	85010	
D2KF18124AA	89409		D5TZ18124B	83308		D7HT18124BA	89409		DU9418080CA	85010	
D2TA-18045-AAA	83219		D5TZ18124C	83312	89409	D7HT18124CA	83314		DU9418080CB	85010	
D2TA-18045-ZA	83219		D5TZ18124C	89409		D7HT18124DA	83309		DU9Z-18124-A	85013	89414
D2TA18045AAA	83219		D7HA-18080-AA	83123	89405	D7HT18124EA	83312	89409	DU9Z-18124-A	89414	
D2TA18045ZA	83219		D7HA-18080-AA	89405		D7HT18124EA	89409		DU9Z-18124-B	85013	89414
D2TF-18045-AA	83312	89409	D7HA18080AA	83123	89405	D7HT18124FA	83312	89409	DU9Z-18124-B	89414	
D2TF-18045-AA	89409		D7HA18080AA	89405		D7HT18124FA	89409		DU9Z-18125-A	85010	
D2TF-18045-FA	83312	89409	D7HF-18045-FA	83312	89409	D7HT18124GA	83308		DU9Z-18125-B	85010	
D2TF-18045-FA	89409		D7HF-18045-FA	89409		D7HT18124HA	83219		DU9Z18124A	85013	89414
D2TF-18045-GA	83308		D7HF-18080-AA	83215		D7HT18124JA	83308		DU9Z18124A	89414	
D2TF-18080-HA	83225		D7HF-18125-AA	83215		D7HT18124KA	85301		DU9Z18124B	85013	89414
D2TF-18124-F	83309		D7HF18045FA	83312	89409	D7HT18125DA	83215		DU9Z18124B	89414	
D2TF18045AA	83312	89409	D7HF18045FA	89409		D7HT18125FA	83123	89405	DU9Z18125A	85010	
D2TF18045AA	89409		D7HF18080AA	83215		D7HT18125FA	89405		DU9Z18125B	85010	
D2TF18045FA	83312	89409	D7HF18125AA	83215		D7HZ-18125-A	83215		EOHT-18045-AA	83309	
D2TF18045FA	89409		D7HT-18045-BA	83312	89409	D7HZ18125A	83215		EOHT-18045-AB	83309	
D2TF18045GA	83308		D7HT-18045-BA	89409		D7KF-18045-EA	83312	89409	EOHT18045AA	83309	
D2TF18080HA	83225		D7HT-18045-CA	83314		D7KF-18045-EA	89409		EOHT18045AB	83309	
D2TF18124F	83309		D7HT-18045-DA	83309		D7KF18045EA	83312	89409	E0HZ-18124-A	83309	
D2TZ-18124-A	83308		D7HT-18045-EA	83312	89409	D7KF18045EA	89409		E0HZ18124A	83309	

**Important Note:** Competitive Interchanges are to be used for stocking purposes only. Where multiple crosses are identified, please reference the applications section of this catalog. / **Remarque importante:** Les interchanges concurrentiels ne s'utilisent qu'aux fins de stocks. Dans le cas de rferences multiples, consulter la section des applications du catalogue. / **Nota importante:** Dans le cas de rferences multiples, consulter la section des applications du catalogue. / **Nota importante:** Se pueden usar intercambios competitivos para propósitos de almacenamiento solamente. Cuando se identifican intercambios múltiples, consulte la sección de aplicaciones de este catálogo.

**COMPETITIVE & O.E.M. INTERCHANGE LIST**  
**Lista de Intercambios contra Competidores y Equipo Original.**  
**Liste dinterchange de produits comptitifs & dquipement original (OEM)**

**Ford... cont'd**

Ford	Gabriel	Upgrade	Ford	Gabriel	Upgrade	Ford	Gabriel	Upgrade	Ford	Gabriel	Upgrade
E1TA-18045-AA	83309		F0HS-18045-AA	85006		F1HZ-18124-F	85006		F4HT18080AA	89425	
E1TA18045AA	83309		F0HS18045AA	85006		F1HZ-18124-G	85006		F4HT18080AB	85314	89425
E1TD-18045-AA	83309		F0HT-18045-AA	85006		F1HZ-18124-H	85040		F4HT18080AB	89425	
E1TD18045AA	83309		F0HT-18045-CA	85006		F1HZ-18124-J	83308		F4HT18080BA	85001	89410
E5HT-18045-AA	85301		F0HT-18080-AA	83122	89406	F1HZ-18124-K	89402		F4HT18080BA	89410	
E5HT-18045-DA	85301		F0HT-18080-AA	89406		F1HZ18124A	83309		F4TA-18045-TA	G63455	
E5HT-18045-EA	85301		F0HT18045AA	85006		F1HZ18124AA	83309		F4TA-18080-PA	G63461	
E5HT-18080-DA	85315		F0HT18045CA	85006		F1HZ18124B	83308		F4TA18045TA	G63455	
E5HT-18080-EA	85315		F0HT18080AA	83122	89406	F1HZ18124C	89402		F4TA18080PA	G63461	
E5HT18045AA	85301		F0HT18080AA	89406		F1HZ18124D	85006		F4TZ-18124-D	G63414	
E5HT18045DA	85301		F0HZ-18124-A	85006		F1HZ18124E	85006		F4TZ-18124-K	G63455	
E5HT18045EA	85301		F0HZ-18124-B	85006		F1HZ18124F	85006		F4TZ-18125-E	G63461	
E5HT18080DA	85315		F0HZ-18125-A	83122	89406	F1HZ18124G	85006		F4TZ18124D	G63414	
E5HT18080EA	85315		F0HZ-18125-A	89406		F1HZ18124H	85040		F4TZ18124K	G63455	
E6HT-18080-AA	83215		F0HZ18124A	85006		F1HZ18124J	83308		F4TZ18125E	G63461	
E6HT18080AA	83215		F0HZ18124B	85006		F1HZ18124K	89402		F57Z-18125-AC	G63679	
E6HZ-18124-A	85301		F0HZ18125A	83122	89406	F1SC-18008-AA	69845		F57Z-18125-BB	G63679	
E6HZ-18124-D	85301		F0HZ18125A	89406		F1SC-18080-AA	69845		F57Z18125AC	G63679	
E6HZ-18125-D	83215		F1HT-18045-AA	83309		F1SZ-18125-B	69845		F57Z18125BB	G63679	
E6HZ-18125-E	85315		F1HT-18045-CA	83308		F2HT-18045-BA	85376		F5HZ-18124-A	83314	
E6HZ-18125-F	85315		F1HT-18045-CB	83216		F2HT-18045-CA	85376		F5HZ-18124-AA	83314	
E6HZ18124A	85301		F1HT-18045-DA	83312	89409	F2HT-18045-DA	85006		F5HZ-18124-B	83107	
E6HZ18124D	85301		F1HT-18045-DA	89409		F2HT-18080-DA	85712		F5HZ-18124-C	85063	
E6HZ18125D	83215		F1HT-18045-DB	83308		F2HT18045BA	85376		F5HZ-18124-D	83125	
E6HZ18125E	85315		F1HT-18045-EA	89402		F2HT18045CA	85376		F5HZ-18124-DA	83125	
E6HZ18125F	85315		F1HT-18045-EB	89402		F2HT18045DA	85006		F5HZ-18125-A	85314	89425
E7HZ-18124-A	85301		F1HT-18045-GA	85006		F2HT18080DA	85712		F5HZ-18125-A	89425	
E7HZ18124A	85301		F1HT-18045-GB	85006		F2HZ-18124-A	85376		F5HZ-18125-AA	85314	89425
E7XZ-18124-A	G63386		F1HT-18045-HB	85006		F2HZ-18124-B	85301		F5HZ-18125-AA	89425	
E7XZ-18124-C	G63511		F1HT-18045-KB	85006		F2HZ-18124-C	85006		F5HZ-18125-B	85001	89410
E7XZ-18125-A	G63350		F1HT-18045-LB	85006		F2HZ-18124-CA	85006		F5HZ-18125-B	89410	
E7XZ-18125-B	G63387		F1HT-18045-NA	85040		F2HZ-18125-A	85712		F5HZ-18125-BA	85001	89410
E7XZ-18125-C	G63409		F1HT-18045-RA	89402		F2HZ-18125-AA	85712		F5HZ-18125-BA	89410	
E7XZ-18125-J	G63299		F1HT-18045-RB	89402		F2HZ18124A	85376		F5HZ-18125-DA	85314	89425
E7XZ18124A	G63386		F1HT18045AA	83309		F2HZ18124B	85301		F5HZ-18125-DA	89425	
E7XZ18124C	G63511		F1HT18045CA	83308		F2HZ18124C	85006		F5HZ18124A	83314	
E7XZ18125A	G63350		F1HT18045CB	83216		F2HZ18124CA	85006		F5HZ18124AA	83314	
E7XZ18125B	G63387		F1HT18045DA	83312	89409	F2HZ18125A	85712		F5HZ18124B	83107	
E7XZ18125C	G63409		F1HT18045DA	89409		F2HZ18125AA	85712		F5HZ18124C	85063	
E7XZ18125J	G63299		F1HT18045DB	83308		F4HT-18045-AB	83314		F5HZ18124D	83125	
E9HS-18045-AA	83309		F1HT18045EA	89402		F4HT-18045-AC	83314		F5HZ18124DA	83125	
E9HS-18080-AA	85716		F1HT18045EB	89402		F4HT-18045-CB	83107		F5HZ18125A	85314	89425
E9HS18045AA	83309		F1HT18045GA	85006		F4HT-18045-DA	85063		F5HZ18125A	89425	
E9HS18080AA	85716		F1HT18045GB	85006		F4HT-18045-EA	83125		F5HZ18125AA	85314	89425
E9HZ-18124-A	83309		F1HT18045HB	85006		F4HT-18080-AA	85314	89425	F5HZ18125AA	89425	
E9HZ-18125-A	85716		F1HT18045KB	85006		F4HT-18080-AA	89425		F5HZ18125B	85001	89410
E9HZ-18125-AA	85716		F1HT18045LB	85006		F4HT-18080-AB	85314	89425	F5HZ18125B	89410	
E9HZ18124A	83309		F1HT18045NA	85040		F4HT-18080-AB	89425		F5HZ18125BA	85001	89410
E9HZ18125A	85716		F1HT18045RA	89402		F4HT-18080-BA	85001	89410	F5HZ18125BA	89410	
E9HZ18125AA	85716		F1HT18045RB	89402		F4HT-18080-BA	89410		F5HZ18125DA	85314	89425
EL3Z 18124-D	G57683		F1HZ-18124-A	83309		F4HT18045AB	83314		F5HZ18125DA	89425	
EL3Z 18124-E	G57683		F1HZ-18124-AA	83309		F4HT18045AC	83314		F5TZ-18124-B	G63608	
EL3Z 18124-F	G57683		F1HZ-18124-B	83308		F4HT18045CB	83107		F5TZ-18125-BC	G63607	
EL3Z 18124-G	G57683		F1HZ-18124-C	89402		F4HT18045DA	85063		F5TZ18124B	G63608	
EL3Z 18124-J	G57683		F1HZ-18124-D	85006		F4HT18045EA	83125		F5TZ18125BC	G63607	
EL3Z 18124-L	G57683		F1HZ-18124-E	85006		F4HT18080AA	85314	89425	F5UZ-18124-A	G63622	

**Important Note:** Competitive Interchanges are to be used for stocking purposes only. Where multiple crosses are identified, please reference the applications section of this catalog. / **Remarque importante:** Les interchanges concurrentiels ne s'utilisent qu'aux fins de stocks. Dans le cas de rferences multiples, consulter la section des applications du catalogue. / **Nota importante:** Dans le cas de rferences multiples, consulter la section des applications du catalogue. / **Nota importante:** Se pueden usar intercambios competitivos para propósitos de almacenamiento solamente. Cuando se identifican intercambios múltiples, consulte la sección de aplicaciones de este catálogo.

**COMPETITIVE & O.E.M. INTERCHANGE LIST**  
**Lista de Intercambios contra Competidores y Equipo Original.**  
**Liste dinterchange de produits compititifs & dquipement original (OEM)**

**Ford... cont'd**

Ford	Gabriel	Upgrade	Ford	Gabriel	Upgrade	Ford	Gabriel	Upgrade	Ford	Gabriel	Upgrade
F5UZ-18124-B	G63622		F6HT18045JC	89402		F6HZ18125A	85314	89425	F87A18045AH	G63772	
F5UZ-18125-A	G63623		F6HT18045KA	89402		F6HZ18125A	89425		F87A18045CC	G63678	
F5UZ-18125-C	G63624		F6HT18045LA	85376		F6HZ18125B	83109		F87A18045JA	G63678	
F5UZ18124A	G63622		F6HT18045MA	85006		F6HZ18125D	85013	89414	F87A18080AC	G63773	
F5UZ18124B	G63622		F6HT18080B	83109		F6HZ18125D	89414		F87A18080BC	G63773	
F5UZ18125A	G63623		F6HT18080CA	85314	89425	F6HZ18125JA	85305		F87Z-18124-AA	G63772	
F5UZ18125C	G63624		F6HT18080CA	89425		F6HZ5K407AB	83034		F87Z-18124-CA	G63678	
F6HT-18045-AA	85054		F6HT18080DA	83109		F77A-18045-AA	G63608		F87Z-18124-JA	G63678	
F6HT-18045-AC	85054		F6HT18080EA	85906	89407	F77A-18080-AA	G63679		F87Z-18125-AA	G63773	
F6HT-18045-BC	85047	89435	F6HT18080EA	89407		F77A-18080-BA	G63607		F87Z-18125-BA	G63773	
F6HT-18045-BC	89435		F6HT18080FC	85013	89414	F77A18045AA	G63608		F87Z-18125-CA	G63773	
F6HT-18045-CC	85055	89439	F6HT18080FC	89414		F77A18080AA	G63679		F87Z-18125-RA	G63775	
F6HT-18045-CC	89439		F6HT18080JA	85305		F77A18080BA	G63607		F87Z18124AA	G63772	
F6HT-18045-EB	85055	89439	F6HT18124JC	89402		F77D-18080-BA	G63679		F87Z18124CA	G63678	
F6HT-18045-EB	89439		F6HT18124KA	89402		F77D18080BA	G63679		F87Z18124JA	G63678	
F6HT-18045-EC	85055	89439	F6HZ-18080-FC	85013	89414	F7C2Z-18124-BR	G63929		F87Z18125AA	G63773	
F6HT-18045-EC	89439		F6HZ-18080-FC	89414		F7C2Z18124BR	G63929		F87Z18125BA	G63773	
F6HT-18045-GB	85030	89440	F6HZ-18124-A	85054		F7TA-18045-AA	G63608		F87Z18125CA	G63773	
F6HT-18045-GB	89440		F6HZ-18124-B	83308		F7TA-18080-BA	G63607		F87Z18125RA	G63775	
F6HT-18045-GC	85030	89440	F6HZ-18124-C	85055	89439	F7TA18045AA	G63608		FB5Z 18125-A	G51980	
F6HT-18045-GC	89440		F6HZ-18124-C	89439		F7TA18080BA	G63607		FB5Z 18125-B	G51980	
F6HT-18045-HB	85054		F6HZ-18124-D	85055	89439	F81A-18080-DCA	G63461		FB5Z 18125-D	G51980	
F6HT-18045-HC	85054		F6HZ-18124-D	89439		F81A-18080-ZC	83140		FB5Z-18125-E	G51980	
F6HT-18045-JB	89402		F6HZ-18124-E	85055	89439	F81A18080DCA	G63461		FC44-18045-AB	85181	
F6HT-18045-JC	89402		F6HZ-18124-E	89439		F81A18080ZC	83140		FC44-18045-BB	85181	
F6HT-18045-KA	89402		F6HZ-18124-F	85055	89439	F81D-18045-CD	83209	89414	FC44-18080-AB	85180	
F6HT-18045-LA	85376		F6HZ-18124-F	89439		F81D-18045-CD	89414		FC4418045BB	85181	
F6HT-18045-MA	85006		F6HZ-18124-G	85054		F81D-18080-CD	83122	89406	FC4418080AB	85180	
F6HT-18080-B	83109		F6HZ-18124-H	85054		F81D-18080-CD	89406		FC4Z-18124-A	85181	
F6HT-18080-CA	85314	89425	F6HZ-18124-J	89402		F81D18045CD	83209	89414	FC4Z-18124-B	85181	
F6HT-18080-CA	89425		F6HZ-18124-KA	89402		F81D18045CD	89414		FC4Z-18124-HB	83135	
F6HT-18080-DA	83109		F6HZ-18124-MA	85006		F81D18080CD	83122	89406	FC4Z-18125-A	85180	
F6HT-18080-EA	85906	89407	F6HZ-18125-A	85314	89425	F81D18080CD	89406		FC4Z-18125-C	83168	
F6HT-18080-EA	89407		F6HZ-18125-A	89425		F81Z-18124-AL	G63622		FC4Z-18125-D	83148	
F6HT-18080-FC	85013	89414	F6HZ-18125-B	83109		F81Z-18124-BK	G63809		FC4Z-18125-E	85978	
F6HT-18080-FC	89414		F6HZ-18125-D	85013	89414	F81Z-18124-CA	83209	89414	FC4Z18124A	85181	
F6HT-18080-JA	85305		F6HZ-18125-D	89414		F81Z-18124-CA	89414		FC4Z18124B	85181	
F6HT-18124-JC	89402		F6HZ-18125-JA	85305		F81Z-18124-PA	85928		FC4Z18124HB	83135	
F6HT-18124-KA	89402		F6HZ-5K407-AB	83034		F81Z-18125-DC	G63461		FC4Z18125A	85180	
F6HT18045AA	85054		F6HZ18080FC	85013	89414	F81Z-18125-FA	83122	89406	FC4Z18125C	83168	
F6HT18045AC	85054		F6HZ18080FC	89414		F81Z-18125-FA	89406		FC4Z18125D	83148	
F6HT18045BC	85047	89435	F6HZ18124A	85054		F81Z-18125-ZA	83140		FC4Z18125E	85978	
F6HT18045BC	89435		F6HZ18124B	83308		F81Z18124AL	G63622		FK3Z-18124-M	G57816	
F6HT18045CC	85055	89439	F6HZ18124C	85055	89439	F81Z18124BK	G63809		FK3Z-18125-C	G64177	
F6HT18045CC	89439		F6HZ18124C	89439		F81Z18124CA	83209	89414	FK4Z-18124-N	G57816	
F6HT18045EB	85055	89439	F6HZ18124D	85055	89439	F81Z18124CA	89414		FK4Z-18125-C	G57816	
F6HT18045EB	89439		F6HZ18124D	89439		F81Z18124PA	85928		FL3Z-18125-K	G64157	
F6HT18045EC	85055	89439	F6HZ18124E	85055	89439	F81Z18125DC	G63461		GL3Z 18124-B	G57683	
F6HT18045EC	89439		F6HZ18124E	89439		F81Z18125FA	83122	89406	GL3Z 18124-C	G57683	
F6HT18045GB	85030	89440	F6HZ18124F	85055	89439	F81Z18125FA	89406		GL3Z 18124-D	G57683	
F6HT18045GB	89440		F6HZ18124F	89439		F81Z18125ZA	83140		GL3Z 18124-E	G57683	
F6HT18045GC	85030	89440	F6HZ18124G	85054		F87A-18045-AH	G63772		GL3Z-18125-E	G64079	
F6HT18045GC	89440		F6HZ18124H	85054		F87A-18045-CC	G63678		GL3Z-18125-F	G64079	
F6HT18045HB	85054		F6HZ18124J	89402		F87A-18045-JA	G63678		GU2Z-18A092-P	G57132	
F6HT18045HC	85054		F6HZ18124KA	89402		F87A-18080-AC	G63773		HC3Z-18124-B	G63622	
F6HT18045JB	89402		F6HZ18124MA	85006		F87A-18080-BC	G63773		HC3Z-18124-C	G63622	

**Important Note:** Competitive Interchanges are to be used for stocking purposes only. Where multiple crosses are identified, please reference the applications section of this catalog. / **Remarque importante:** Les interchanges concurrentiels ne s'utilisent qu'aux fins de stocks. Dans le cas de rfrences multiples, consulter la section des applications du catalogue. / **Nota importante:** Dans le cas de rfrences multiples, consultar la section des aplicaciones du catalogue. / **Nota importante:** Se pueden usar intercambios competitivos para propósitos de almacenamiento solamente. Cuando se identifican intercambios múltiples, consulte la sección de aplicaciones de este catálogo.

**COMPETITIVE & O.E.M. INTERCHANGE LIST**  
**Lista de Intercambios contra Competidores y Equipo Original.**  
**Liste dinterchange de produits comptitifs & dquipement original (OEM)**

**Ford... cont'd**

Ford	Gabriel	Upgrade	Ford	Gabriel	Upgrade	Ford	Gabriel	Upgrade	Ford	Gabriel	Upgrade
HC3Z-18124-G	G63622		HU9Z-18125-B	83122	89406	TACAA18045A	83216		XL24-18045-BA	G63678	
HC3Z-18124-J	77967		HU9Z-18125-B	89406		TANNA-18045-A	83312	89409	XL24-18045-EA	G63678	
HC3Z-18124-U	G63886		HU9Z-18125-C	83122	89406	TANNA-18045-A	89409		XL24-18045-JA	G63678	
HC3Z-18125-B	77987		HU9Z-18125-C	89406		TANNA18045A	83312	89409	XL24-18080-BA	G63679	
HC3Z-18125-ED	77987		HU9Z18124A	85006		TANNA18045A	89409		XL24-18080-CA	G63679	
HC3Z-18125-EE	77987		HU9Z18124B	83209	89414	TDBA-18045-A	83219		XL24-18080-EA	G63679	
HC3Z-18125-EP	77986		HU9Z18124B	89414		TDBA-18045-B	83219		XL2418045BA	G63678	
HC3Z-18125-X	77986		HU9Z18124C	83209	89414	TDBA18045A	83219		XL2418045EA	G63678	
HG9Z 18124-A	G57812		HU9Z18124C	89414		TDBA18045B	83219		XL2418045JA	G63678	
HG9Z 18124-B	G57812		HU9Z18125A	85005	89430	TDBE-18045-A	83219		XL2418080BA	G63679	
HG9Z 18124-D	G57812		HU9Z18125A	89430		TDBE18045A	83219		XL2418080CA	G63679	
HG9Z 18124-F	G57812		HU9Z18125B	83122	89406	TFAA-18045-B	83219		XL2418080EA	G63679	
HG9Z 18124-G	G57812		HU9Z18125B	89406		TFAA-18045-C	83219		XL2Z-18124-BA	G63678	
HG9Z 18124-H	G57812		HU9Z18125C	83122	89406	TFAA-18080-A	85307		XL2Z-18124-EA	G63678	
HG9Z 18124-J	G57812		HU9Z18125C	89406		TFAA18045B	83219		XL2Z-18124-JA	G63678	
HG9Z 18124-K	G57812		JL3Z 18124-D	G57683		TFAA18045C	83219		XL2Z-18125-BA	G63679	
HG9Z 18124-L	G57812		JL3Z 18124-E	G57683		TFAA18080A	85307		XL2Z-18125-CA	G63679	
HG9Z 18124-M	G57812		JL3Z 18124-F	G57683		THAB-18045-A	83219		XL2Z-18125-EA	G63679	
HG9Z 18124-N	G57812		JL3Z-18124-B	G57683		THAB-18045-B	83219		XL2Z18124BA	G63678	
HG9Z 18124-P	G57812		JL3Z-18124-J	G57683		THAB18045A	83219		XL2Z18124EA	G63678	
HU9418045AA	83209	89414	KC3Z-3E651-C	14072		THAB18045B	83219		XL2Z18124JA	G63678	
HU9418045AA	89414		LC3Z-18125-J	77986		TQSH-18045-A	83309		XL2Z18125BA	G63679	
HU9418045BA	83209	89414	LC3Z-18125-W	77986		TQSH18045A	83309		XL2Z18125CA	G63679	
HU9418045BA	89414		M5L3Z-18124-HA	G51703		XC35-18045-AB	83131		XL2Z18125EA	G63679	
HU9Z-18045-AA	83209	89414	M5L3Z-18124-HA	G51704		XC35-18045-AD	83131		XL58-18080-AC	G63773	
HU9Z-18045-BA	83209	89414	M5L3Z-18125-BA	G63867		XC35-18045-JA	83131		XL5818080AC	G63773	
HU9Z-18124-A	85006		M5L3Z-18125-BA	G63870		XC3518045AB	83131		XL5Z-18125-AA	G63773	
HU9Z-18124-B	83209	89414	M7C3Z-18124-AKA	G63622		XC3518045AD	83131		XL5Z18125AA	G63773	
HU9Z-18124-B	89414		MAA568	G63614		XC3518045JA	83131		YL5Z-18124-AA	G63772	
HU9Z-18124-C	83209	89414	MBE8Z-18124-A	G52256		XC3Z-18124-JA	83131		YL5Z18124AA	G63772	
HU9Z-18124-C	89414		MBE8Z-18124-B	G52355		XC3Z18124JA	83131				
HU9Z-18125-A	85005	89430	MR-AB-415	G63678		XC45-18045-AA	83216				
HU9Z-18125-A	89430		TACAA-18045-A	83216		XC4518045AA	83216				

**Forest River**

Forest river	Gabriel	Upgrade	Forest river	Gabriel	Upgrade	Forest river	Gabriel	Upgrade	Forest river	Gabriel	Upgrade
141700131809	85029		66153-002	83124	89407	9U9Z-18125-A	83122	89406	ASH-1229	89414	
141700131810	83160		66153-002	89407		9U9Z-18125-A	89406		ASH-1230	83122	89406
16-16736-000	85029		66153002	83124	89407	9U9Z18124A	83209	89414	ASH-1230	89406	
16-16737-000	83160		66153002	89407		9U9Z18124A	89414		ASH-137	83122	89406
16-16873-000	85029		8C24-18045-DA	G63622		9U9Z18125A	83122	89406	ASH-137	89406	
16-16874-000	83160		8C24-18080-DB	G63623		9U9Z18125A	89406		ASH-25820	85005	89430
16-18103-000	85900		8C2418045DA	G63622		ASH-1022	83209	89414	ASH-25820	89430	
1616736000	85029		8C2418080DB	G63623		ASH-1022	89414		ASH-25821	85006	
1616737000	83160		8C2Z-18124-D	G63622		ASH-1023	83122	89406	ASH-25822	83209	89414
1616873000	85029		8C2Z-18125-D	G63623		ASH-1023	89406		ASH-25822	89414	
1616874000	83160		8C2Z18124D	G63622		ASH-1136	G63623		ASH-25823	83209	89414
1618103000	85900		8C2Z18125D	G63623		ASH-1154	G63622		ASH-25823	89414	
1C34-18045-AA	83209	89414	9U94-18045-AA	83209	89414	ASH-1161	85006		ASH-25824	83122	89406
1C34-18045-AA	89414		9U94-18045-AA	89414		ASH-1162	85005	89430	ASH-25824	89406	
1C34-18045-JA	83209	89414	9U94-18080-AA	83122	89406	ASH-1162	89430		ASH-294	83209	89414
1C34-18045-JA	89414		9U94-18080-AA	89406		ASH-1205	83209	89414	ASH-294	89414	
1C3418045AA	83209	89414	9U9418045AA	83209	89414	ASH-1205	89414		ASH1022	83209	89414
1C3418045AA	89414		9U9418045AA	89414		ASH-1206	83122	89406	ASH1022	89414	
1C3418045JA	83209	89414	9U9418080AA	83122	89406	ASH-1206	89406				
1C3418045JA	89414		9U9418080AA	89406		ASH-1228	83209	89414			
481700000490	85900		9U9Z-18124-A	83209	89414	ASH-1228	89414				
481700000493	85900		9U9Z-18124-A	89414		ASH-1229	83209	89414			

**Important Note:** Competitive Interchanges are to be used for stocking purposes only. Where multiple crosses are identified, please reference the applications section of this catalog. / **Remarque importante:** Les interchanges concurrentiels ne s'utilisent qu'aux fins de stocks. Dans le cas de rferences multiples, consulter la section des applications du catalogue. / **Nota importante:** Dans le cas de rferences multiples, consulter la section des aplicaciones del catalogo. / **Nota importante:** Se pueden usar intercambios competitivos para propósitos de almacenamiento solamente. Cuando se identifican intercambios múltiples, consulte la sección de aplicaciones de este catálogo.



**COMPETITIVE & O.E.M. INTERCHANGE LIST**  
**Lista de Intercambios contra Competidores y Equipo Original.**  
**Liste dinterchange de produits comptitifs & dquipement original (OEM)**

**Forest River... cont'd**

Forest river	Gabriel	Upgrade	Forest river	Gabriel	Upgrade	Forest river	Gabriel	Upgrade	Forest river	Gabriel	Upgrade
ASH1023	83122	89406	ASH1229	83209	89414	ASH25824	83122	89406	AT164G	G63623	
ASH1023	89406		ASH1229	89414		ASH25824	89406		AT620	83209	89414
ASH1136	G63623		ASH1230	83122	89406	ASH294	83209	89414	AT620	89414	
ASH1154	G63622		ASH1230	89406		ASH294	89414		AT621	83122	89406
ASH1161	85006		ASH137	83122	89406	AT-163G	G63622		AT621	89406	
ASH1162	85005	89430	ASH137	89406		AT-164G	G63623		AT766	83209	89414
ASH1162	89430		ASH25820	85005	89430	AT-620	83209	89414	AT766	89414	
ASH1205	83209	89414	ASH25820	89430		AT-620	89414		F4-BE5-C832-MO	83124	89407
ASH1205	89414		ASH25821	85006		AT-621	83122	89406	F4-BE5-C832-MO	89407	
ASH1206	83122	89406	ASH25822	83209	89414	AT-621	89406		F4BE5C832MO	83124	89407
ASH1206	89406		ASH25822	89414		AT-766	83209	89414	F4BE5C832MO	89407	
ASH1228	83209	89414	ASH25823	83209	89414	AT-766	89414				
ASH1228	89414		ASH25823	89414		AT163G	G63622				

**Freightliner**

Freightliner	Gabriel	Upgrade	Freightliner	Gabriel	Upgrade	Freightliner	Gabriel	Upgrade	Freightliner	Gabriel	Upgrade
10-12030-002	85320	89429	10-13809-000	85958		1013634000	89449		141700131809	85029	
10-12030-002	89429		10-13859-000	85005	89430	1013684000	85918	89449	141700131810	83160	
10-12032-000	85320	89429	10-13859-000	89430		1013684000	89449		141700131975	83160	
10-12032-000	89429		10-13976-000	85918	89449	1013759000	85006		141700131980	83160	
10-12032-001	85320	89429	10-13976-000	89449		1013760000	85959		16-11133-000	85007	
10-12032-001	89429		10-14193-000	83396		1013776000	85005	89430	16-12117-000	85007	
10-12032-002	85320	89429	10-14339-000	83396		1013776000	89430		16-13947-000	85319	89428
10-12032-002	89429		1012030002	85320	89429	1013809000	85958		16-13947-000	89428	
10-12032-003	85320	89429	1012030002	89429		1013859000	85005	89430	16-13957-000	85724	89443
10-12032-003	89429		1012032000	85320	89429	1013859000	89430		16-13957-000	89443	
10-12032-004	85320	89429	1012032000	89429		1013976000	85918	89449	16-14259-000	85331	
10-12032-004	89429		1012032001	85320	89429	1013976000	89449		16-14577-000	85043	
10-12046-000	85320	89429	1012032001	89429		1014193000	83396		16-14667-000	85005	89430
10-12046-000	89429		1012032002	85320	89429	1014282000	83396		16-14667-000	89430	
10-12388-000	85920	89503	1012032002	89429		1014339000	83396		16-14668-000	83127	
10-12388-000	89503		1012032003	85320	89429	1201-0012	83023		16-14669-000	G63403	
10-12390-000	85920	89503	1012032003	89429		1201-0054	83021		16-14759-000	85000	89436
10-12390-000	89503		1012032004	85320	89429	1201-1043	83025		16-14759-000	89436	
10-12396-000	85918	89449	1012032004	89429		1201-1044	83025		16-14794-000	83154	
10-12396-000	89449		1012046000	85320	89429	12010012	83023		16-15064-000	83154	
10-12542-000	85901		1012046000	89429		12010054	83021		16-15089-000	83164	
10-12703-000	85918	89449	1012388000	85920	89503	12011043	83025		16-15394-000	83120	
10-12703-000	89449		1012388000	89503		12011044	83025		16-15436-000	83154	
10-13021-000	85918	89449	1012390000	85920	89503	1202-0012	83023		16-15473-000	83157	
10-13021-000	89449		1012390000	89503		1202-0032	83016		16-15474-000	83157	
10-13051-001	85005	89430	1012396000	85918	89449	1202-0042	83025		16-15475-000	83164	
10-13051-001	89430		1012396000	89449		1202-0043	83025		16-15591-000	85043	
10-13063-000	85918	89449	1012542000	85901		1202-0044	83025		16-15592-000	83154	
10-13063-000	89449		1012703000	85918	89449	1202-0054	83021		16-15592-000	83154	
10-13205-000	85918	89449	1012703000	89449		1202-1043	83025		16-15676-000	85058	89431
10-13205-000	89449		1013021000	85918	89449	1202-1044	83025		16-15676-000	89431	
10-13211-000	85918	89449	1013021000	89449		12020012	83023		16-15705-000	83120	
10-13211-000	89449		1013051001	85005	89430	12020032	83016		16-15755-000	85043	
10-13592-000	85959		1013051001	89430		12020042	83025		16-15765-000	85921	
10-13634-000	85918	89449	1013063000	85918	89449	12020043	83025		16-15770-000	85956	
10-13634-000	89449		1013063000	89449		12020044	83025		16-15805-000	83120	
10-13684-000	85918	89449	1013205000	85918	89449	12020054	83021		16-15817-000	85724	89443
10-13684-000	89449		1013205000	89449		12021043	83025		16-15817-000	89443	
10-13759-000	85006		1013211000	85918	89449	12021044	83025		16-15934-000	83120	
10-13760-000	85959		1013211000	89449		1398980	83127				
10-13776-000	85005	89430	1013592000	85959		141700000377	83160				
10-13776-000	89430		1013634000	85918	89449	141700000378	83160				

**Important Note:** Competitive Interchanges are to be used for stocking purposes only. Where multiple crosses are identified, please reference the applications section of this catalog. / **Remarque importante:** Les interchanges concurrentiels ne s'utilisent qu'aux fins de stocks. Dans le cas de rfrences multiples, consulter la section des applications du catalogue. / **Nota importante:** En el caso de referencias multiples, consultar la sección de aplicaciones del catálogo. / **Nota importante:** Se pueden usar intercambios competitivos para propósitos de almacenamiento solamente. Cuando se identifican intercambios múltiples, consulte la sección de aplicaciones de este catálogo.

**COMPETITIVE & O.E.M. INTERCHANGE LIST**  
**Lista de Intercambios contra Competidores y Equipo Original.**  
**Liste dinterchange de produits comptitifs & dquipement original (OEM)**

**Freightliner... cont'd**

Freightliner	Gabriel	Upgrade	Freightliner	Gabriel	Upgrade	Freightliner	Gabriel	Upgrade	Freightliner	Gabriel	Upgrade
16-16043-000	85043		1613957000	89443		1618103000	85900		1837813000	83044	
16-16082-000	85043		1614259000	85331		1618455000	85918	89449	1841762000	83038	
16-16083-000	85331		1614577000	85043		1618455000	89449		1841762001	83047	
16-16093-000	83160		1614667000	85005	89430	1618456000	85959		1841762002	83038	
16-16262-000	83120		1614667000	89430		1618705000	85007		1844321000	83009	
16-16442-000	83134		1614668000	83127		1618706000	85331		1845067000	83034	
16-16486-000	83134		1614669000	G63403		1618707000	85921		1847349000	83039	
16-16542-000	83154		1614759000	85000	89436	1618708000	85724	89443	1847350000	83040	
16-16577-000	85335		1614759000	89436		1618708000	89443		1860295000	83006	
16-16736-000	85029		1614794000	83154		1618709000	83134		1860764000	83038	
16-16737-000	83160		1615064000	83154		1618710000	83134		1860765000	83038	
16-16764-000	85724	89443	1615394000	83120		1618711000	85335		1860765001	83047	
16-16764-000	89443		1615436000	83154		1619138000	85058	89431	1860765002	83038	
16-16765-000	85006		1615473000	83157		1619138000	89431		1860766000	83040	
16-16826-000	85043		1615474000	83157		1620552000	83154		1860767000	83039	
16-16827-000	85331		1615475000	83164		1620632000	85919		1860769000	83009	
16-16836-000	83154		1615591000	85043		1620716000	85724	89443	1860772000	83026	
16-16873-000	85029		1615592000	83154		1620716000	89443		1860773000	83027	
16-16874-000	83160		1615676000	85058	89431	16725-01	83126	89430	1867845000	83906	
16-17144-000	85900		1615676000	89431		16725-01	89430		1869674000	83906	
16-17211-000	85909		1615705000	83120		1672501	83126	89430	1873207000	83911	
16-17361-000	85900		1615755000	85043		1672501	89430		19495-01	83126	89430
16-17684-000	85058	89431	1615765000	85921		17455-00	89430		19495-01	89430	
16-17684-000	89431		1615770000	85956		18-29846-000	83009		1949501	83126	89430
16-17759-000	85919		1615805000	83120		18-30378	83006		1949501	89430	
16-17760-000	85331		1615817000	85724	89443	18-30378-000	83001		3638112	G63183	
16-18075-000	83160		1615817000	89443		18-30378-000	83006		4036892	G63605	
16-18076-000	83160		1615934000	83120		18-32999-000	83001		471700000440	85959	
16-18094-000	85959		1616043000	85043		18-32999-001	83006		471700000447	85919	
16-18103-000	85900		1616082000	85043		18-37813-000	83044		471700000449	85918	89449
16-18455-000	85918	89449	1616083000	85331		18-41762-000	83038		471700000449	89449	
16-18455-000	89449		1616093000	83160		18-41762-001	83047		471700000450	89449	
16-18456-000	85959		1616262000	83120		18-41762-002	83038		471700000466	85959	
16-18705-000	85007		1616442000	83134		18-44321-000	83009		471700000470	85918	89449
16-18706-000	85331		1616486000	83134		18-45067-000	83034		471700000470	89449	
16-18707-000	85921		1616542000	83154		18-47349-000	83039		471700002726	85918	89449
16-18708-000	85724	89443	1616577000	85335		18-47350-000	83040		471700002726	89449	
16-18708-000	89443		1616736000	85029		18-60295-000	83006		471700002727	85959	
16-18709-000	83134		1616737000	83160		18-60764-000	83038		471700002808	85724	89443
16-18710-000	83134		1616764000	85724	89443	18-60765-000	83038		471700002808	89443	
16-18711-000	85335		1616764000	89443		18-60765-001	83047		471700002809	85724	89443
16-19138-000	85058	89431	1616765000	85006		18-60765-002	83038		471700002809	89443	
16-19138-000	89431		1616826000	85043		18-60766-000	83040		471700002990	85007	
16-20552-000	83154		1616827000	85331		18-60767-000	83039		471700002991	85959	
16-20628-000	85058	89431	1616836000	83154		18-60769-000	83009		471700002992	85331	
16-20628-000	89431		1616873000	85029		18-60772-000	83026		471700002993	85921	
16-20632-000	85919		1616874000	83160		18-60773-000	83027		471700002994	83134	
16-20716-000	85724	89443	1617144000	85900		18-67845-000	83906		471700002995	83134	
16-20716-000	89443		1617211000	85909		18-69674-000	83906		471700002996	85335	
16-22004-000	85058	89431	1617361000	85900		18-73207-000	83911		471700003000	85335	
16-22004-000	89431		1617684000	85058	89431	1829846000	83009		471700003009	85006	
1611133000	85007		1617684000	89431		1830378	83006		471700003011	85058	89431
1612117000	85007		1617759000	85919		1830378000	83001		471700003011	89431	
1613947000	85319	89428	1617760000	85331		1830378000	83006		471700003920	85958	
1613947000	89428		1618076000	83160		1832999000	83001		471700005079	85005	89430
1613957000	85724	89443	1618094000	85959		1832999001	83006		471700005079	89430	

**Important Note:** Competitive Interchanges are to be used for stocking purposes only. Where multiple crosses are identified, please reference the applications section of this catalog. / **Remarque importante:** Les interchanges concurrentiels ne s'utilisent qu'aux fins de stocks. Dans le cas de références multiples, consulter la section des applications du catalogue. / **Nota importante:** Dans le cas de referencias multiples, consultar la sección de aplicaciones del catálogo. / **Nota importante:** Se pueden usar intercambios competitivos para propósitos de almacenamiento solamente. Cuando se identifican intercambios múltiples, consulte la sección de aplicaciones de este catálogo.

**COMPETITIVE & O.E.M. INTERCHANGE LIST**  
**Lista de Intercambios contra Competidores y Equipo Original.**  
**Liste dinterchange de produits comptitifs & dquipement original (OEM)**

**Freightliner... cont'd**

Freightliner	Gabriel	Upgrade	Freightliner	Gabriel	Upgrade	Freightliner	Gabriel	Upgrade	Freightliner	Gabriel	Upgrade
471700006269	85932	89453	58913003	85932	89453	665409	85009		814903003496	83009	
471700006269	89453		58913003	89453		665545401	89430		814903003528	83038	
471700010991	83154		58913003L	85932	89453	671908	85918	89449	814903003530	83038	
471700011302	85058	89431	58913003L	89453		671908	89449		814903012666	83906	
471700011302	89431		58913012	85932	89453	671945	85920	89503	814903012670	83906	
471700131155	85918	89449	58913012	89453		671945	89503		814903015188	83906	
471700131155	89449		58913012L	85932	89453	671946	85921		814903015190	83906	
471700131331	85932	89453	58913012L	89453		680008	85300	89419	814903018451	83911	
471700131331	89453		58913015	85200		680008	89419		90044162	83128	89436
471700131646	85918	89449	60680-004	83143		680009	85302	89420	90044162	89436	
471700131646	89449		60680-004L	83143		680009	89420		90045083	85910	
471700131650	85918	89449	60680-005	83142		680017	85302	89420	A90193	83396	
471700131650	89449		60680-005L	83142		680017	89420		GBL 650361	83017	
471700131775	85006		60680004	83143		6803230200	85043		GBL 651375	83119	
471700131778	85331		60680004L	83143		6803230300	85006		GBL654725	83120	
471700131780	85331		60680005	83142		6803260000	83120		GBL654726	83120	
471700131974	85029		60680005L	83142		680339	85724	89443	GBL654727	83120	
47902-13	83122	89406	61300224	85918	89449	680339	89443		GBL654728	83120	
47902-13	89406		61300224	89449		680442	85319	89428	GBL654729	83120	
4790213	83122	89406	61300240	85918	89449	680442	89428		GBL654730	83120	
4790213	89406		61300240	89449		680511	85331		GBL654731	83120	
481700000477	85900		650224	83225		680611	85724	89443	GBL654732	83120	
481700000480	85900		654654	85043		680611	89443		GBL654733	83120	
481700000490	85900		654739	83009		680651	85335		GBL654734	83120	
481700000493	85900		654819	83001		680782	85302	89420	GBL654735	83120	
481700006848	85724	89443	654831	83006		680782	89420		GBL665538	85006	
481700006848	89443		654953	85058	89431	681-323-0900	85009		H60680004	83143	
481700006850	85724	89443	654953	89431		681-323-1100	85301		HDR60680-004	83143	
481700006850	89443		654990	83038		681-326-0400	85319	89428	HDR60680-005	83142	
481700125969	85956		659060	85920	89503	681-326-0400	89428		HDR60680004	83143	
481700125970	85956		659060	89503		681-891-02-05	83017		HDR60680005	83142	
481700131919	85900		659062	83134		6813230900	85009		MAE 16949	83120	
481700131920	85900		659063	83134		6813231100	85301		P117099	83120	
535228	85302	89420	659079	83040		6813260400	85319	89428	RW24285	83119	
535228	89420		659080	83039		6813260400	89428		SDA471400003920	85958	
58913-003	85932	89453	659125	83047		6818910205	83017		SDA471700000440	85959	
58913-003	89453		659178	83038		70029	85308	89422	SDA471700002809	85724	89443
58913-003L	85932	89453	659227	85058	89431	70029	89422		SDA471700002809	89443	
58913-003L	89453		659227	89431		70042	85302	89420	SDA471700002991	85959	
58913-012	85932	89453	659288	83006		70042	89420		SDA471700003920	85958	
58913-012	89453		659300	85005	89430	814903003482	83040		X9007009-73	83396	
58913-012L	85932	89453	659300	89430		814903003483	83039				
58913-012L	89453		665174	85060		814903003486	83047				
58913-015	85200		665236	85007		814903003490	83047				

**Fruehauf**

Fruehauf	Gabriel	Upgrade	Fruehauf	Gabriel	Upgrade	Fruehauf	Gabriel	Upgrade	Fruehauf	Gabriel	Upgrade
144-5910	85300	89419	680298	85321		UCD62161	83203	89436	UCE12951	85300	89419
144-5910	89419		UCA-01113	85304		UCD62161	89436		UCE12951	89419	
1445910	85300	89419	UCA-5431	85305		UCE-1295-1	85300	89419	UCE1295901	85300	89419
1445910	89419		UCA01113	85304		UCE-1295-1	89419		UCE1295901	89419	
5116-117	83122	89406	UCA5431	85305		UCE-1295-901	85300	89419	UCE2983000	85322	
5116-117	89406		UCD-006216-001	83203	89436	UCE-1295-901	89419		UCE2983001	85322	
5116117	83122	89406	UCD-006216-001	89436		UCE-2983-000	85322		UCE29831	85322	
5116117	89406		UCD-6216-1	83203	89436	UCE-2983-001	85322				
5352858	85305		UCD-6216-1	89436		UCE-2983-1	85322				
680117	85300	89419	UCD006216001	83203	89436	UCE-9399-1	83122	89406			
680117	89419		UCD006216001	89436		UCE-9399-1	89406				

**Important Note:** Competitive Interchanges are to be used for stocking purposes only. Where multiple crosses are identified, please reference the applications section of this catalog. / **Remarque importante:** Les interchanges concurrentiels ne s'utilisent qu'aux fins de stocks. Dans le cas de rfrences multiples, consulter la section des applications du catalogue. / **Nota importante:** Dans le cas de rfrences multiples, consulter la section des applications du catalogue. / **Nota importante:** Se pueden usar intercambios competitivos para propósitos de almacenamiento solamente. Cuando se identifican intercambios múltiples, consulte la sección de aplicaciones de este catálogo.

**COMPETITIVE & O.E.M. INTERCHANGE LIST**  
**Lista de Intercambios contra Competidores y Equipo Original.**  
**Liste dinterchange de produits comptitifs & dquipement original (OEM)**

**Fruehauf... cont'd**

Fruehauf	Gabriel	Upgrade	Fruehauf	Gabriel	Upgrade	Fruehauf	Gabriel	Upgrade	Fruehauf	Gabriel	Upgrade
UCE93991	83122	89406	UCF-8339-002	85321		UEY 1124-001	85030	89440	UEY 1124001	89440	
UCE93991	89406		UCF8339001	85321		UEY 1124-001	89440				
UCF-8339-001	85321		UCF8339002	85321		UEY 1124001	85030	89440			

**FWD Truck**

Fwd truck	Gabriel	Upgrade	Fwd truck	Gabriel	Upgrade	Fwd truck	Gabriel	Upgrade	Fwd truck	Gabriel	Upgrade
450739	85302	89420	450739	89420							

**GasSLX**

GasSLX	Gabriel	Upgrade	GasSLX	Gabriel	Upgrade	GasSLX	Gabriel	Upgrade	GasSLX	Gabriel	Upgrade
89405	83123		89419	85300		89431	85058		89448	85066	
89405	85036		89420	85302		89434	85046		89449	85918	
89406	83122		89422	85303		89435	85047		89450	85061	
89407	83124		89422	85308		89436	83128		89451	85067	
89407	83207		89423	85310		89436	83203		89453	85932	
89407	85906		89424	85311		89436	83389		89454	85933	
89408	85062		89425	85314		89436	85000		89455	85069	
89409	83312		89426	85316		89436	85323		89456	85936	
89410	85001		89427	85033		89439	85055		89457	85924	
89411	85003		89428	85319		89440	85030		89458	85923	
89413	85012		89429	85320		89442	85053		89458	85931	
89414	83209		89430	83126		89443	85724		89459	85070	
89414	85013		89430	85005		89447	83456		89460	85084	
89415	85023		89430	85916		89447	85705		89503	85920	

**GasSLX - Fleetline**

GasSLX - fleetline	Gabriel	Upgrade	GasSLX - fleetline	Gabriel	Upgrade	GasSLX - fleetline	Gabriel	Upgrade	GasSLX - fleetline	Gabriel	Upgrade
83122	89406		85005	89430		85066	89448		85320	89429	
83123	89405		85012	89413		85067	89451		85323	89436	
83124	89407		85013	89414		85069	89455		85705	89447	
83126	89430		85023	89415		85070	89459		85724	89443	
83128	89436		85030	89440		85084	89460		85906	89407	
83203	89436		85033	89427		85300	89419		85916	89430	
83207	89407		85036	89405		85302	89420		85918	89449	
83209	89414		85046	89434		85303	89422		85920	89503	
83312	89409		85047	89435		85308	89422		85923	89458	
83389	89436		85053	89442		85310	89423		85924	89457	
83456	89447		85055	89439		85311	89424		85931	89458	
85000	89436		85058	89431		85314	89425		85932	89453	
85001	89410		85061	89450		85316	89426		85933	89454	
85003	89411		85062	89408		85319	89428		85936	89456	

**General Motors**

General motors	Gabriel	Upgrade	General motors	Gabriel	Upgrade	General motors	Gabriel	Upgrade	General motors	Gabriel	Upgrade
1-51630-168-1	83515		1202-0032	83016		12474721	77638		1516302171	83114	
1-51630-217-0	83114		1202-0054	83021		12474721	G63638		1516302191	83114	
1-51630-217-1	83114		1202-1043	83025		12474915	83122	89406	15172340	G63842	
1-51630-219-1	83114		12020012	83023		12474915	89406		15172342	G63842	
10363555	69589		12020032	83016		12474917	83137		15174898	83136	
10363583	143074		12020054	83021		12477893	49213		15174902	85071	
10363584	143073		12021043	83025		12477894	49213		15195073	G51718	
10368516	69587		12474692	49213		12477894	61528		15198894	G51718	
10379370	69590		12474692	61528		15023687	49213		15206892	G63842	
10443949	69676		12474694	49213		15098725	G51718		15211377	49228	
11569856	143366		12474719	61544		15098726	G51718		15211378	49228	
1201-0054	83021		12474719	G63489		15098727	G51718		15232939	143366	
1201-1043	83025		12474721	43180		15123676	83136		15260892	G63842	
12010054	83021		12474721	49231		15125521	G51718		15294604	69589	
12011043	83025		12474721	58638		1516301681	83515		15588554	83136	
1202-0012	83023		12474721	61565		1516302170	83114		15642943	83136	

**Important Note:** Competitive Interchanges are to be used for stocking purposes only. Where multiple crosses are identified, please reference the applications section of this catalog. / **Remarque importante:** Les interchanges concurrentiels ne s'utilisent qu'aux fins de stocks. Dans le cas de rferences multiples, consulter la section des applications du catalogue. / **Nota importante:** Dans le cas de rferences multiples, consulter la section des applications du catalogue. / **Nota importante:** Se pueden usar intercambios competitivos para propósitos de almacenamiento solamente. Cuando se identifican intercambios múltiples, consulte la sección de aplicaciones de este catálogo.

**COMPETITIVE & O.E.M. INTERCHANGE LIST**  
**Lista de Intercambios contra Competidores y Equipo Original.**  
**Liste dinterchange de produits comptitifs & dquipement original (OEM)**

**General Motors... cont'd**

General motors	Gabriel	Upgrade	General motors	Gabriel	Upgrade	General motors	Gabriel	Upgrade	General motors	Gabriel	Upgrade
15740554	83137		19168458	G63803		19300035	49228		20955413	G63959	
15786900	49228		19171474	143089		19300057	58803		20955414	61690	
15786901	49228		19172175	6850SE		19300057	61643		20955414	G63959	
15789588	G51718		19172178	6853SE		19300057	77803		20955415	61690	
15789590	G51718		19177785	G51718		19300057	G63803		20955415	G63959	
15791315	69589		19203623	G51746		19307628	70031		20955417	61690	
15806823	G64015		19203641	61687		19324428	G57048		20955417	G63959	
15836873	143354		19208029	G52116		19324429	G57047		20955422	61690	
15836873	143355		19208306	G52127		19324431	49255		20955422	G63959	
15836874	143355		19208307	G52128		19325299	70059		20955425	61690	
15836875	143354		19235148	61683		19359124	G511030		20955425	G63959	
15836875	143355		19235151	61690		19368462	49235		20955427	G63959	
15840282	143316		19241354	61684		19368462	61675		20955486	G51870	
15845231	61718		19241355	61685		19368462	G63866		20955487	G51870	
15845231	G64015		19241356	49254		19402811	83397		20955495	G51870	
15864982	G57070		19241357	61717		19403619	83397		20955497	G51870	
15873313	49228		19241358	61718		19403620	83397		20955498	G51870	
15873314	49228		19241359	69590		19404855	83135		20955500	G51870	
15887728	83136		19257307	G63894		19407869	83397		20955506	G51870	
1591501	85722		19257308	G63893		19407870	83398		20955513	G51891	
15935605	43181		19257309	G63894		19407871	83397		20955514	G51870	
15935605	61600		19257310	G63895		19407873	83398		20956372	G63896	
15935611	58412		19257311	G63893		19408176	85670		20956377	61687	
15935611	61642		19293025	143281		20757505	G64040		20956377	G63897	
15935611	77412		19294074	142245		20759948	49228		20956378	G63896	
15935621	43181		19294075	142249		20759949	49228		20956379	61687	
15935625	58412		19294076	142245		20760400	G64040		20956379	G63897	
15935625	61642		19294098	142526		20765171	G51870		20956380	61687	
15935625	77412		19294099	142526		20765189	G51870		20956380	G63897	
15935629	61600		19294102	142530		20765189	G57000		20958798	G51891	
15943270	61659		19294112	143073		20765189	G57023		20958799	G51891	
15963161	83122	89406	19294113	143074		20784307	G64040		20982300	G51982	
15963161	89406		19294124	143058		20808505	G64140		22002293	83126	89430
15998555	49213		19294124	143059		20832848	G64040		22002293	89430	
18041276	69845		19294294	143094		20832849	G64040		22002295	83303	
19122332	G56773		19294296	143425		20833776	G63959		22007700	83207	89407
19122333	G56774		19294297	143323		20837766	61690		22007700	89407	
19126029	61777		19294298	143316		20837766	G63959		22007701	83126	89430
19132275	143057		19294299	143061		20862317	G64040		22007701	89430	
19132276	143058		19294301	143063		20906289	G64121		22007703	83303	
19132277	143059		19294302	143064		20908412	G64148		22007750	83207	89407
19132279	143061		19294330	G57048		20908414	G64148		22007750	89407	
19132376	143072		19294331	G57047		20908415	G64148		22007751	83303	
19132377	143073		19294349	81930		20909154	G52127		22007753	83303	
19152843	83136		19295551	81318		20909155	G52128		22012065	85304	
19152953	G57070		19295552	81873		20929418	70059		22012067	85700	
19153639	G63884		19295553	81920		20930989	G63882		22012082	85702	
19153641	G51850		19295555	81922		20930995	G63879		22012083	85711	
19158776	58930		19295556	81924		20944661	G51982		22012083GS	85711	
19158788	61675		19295557	81925		20955404	61690		22012090	85308	89422
19158789	77953		19295558	69587		20955404	G63959		22012090	89422	
19167562	81039		19295559	69589		20955406	77975		22012091	85303	89422
19167562	G63355		19299843	49228		20955406	G64101		22012091	89422	
19168179	61641		19299843	49255		20955408	77975		22012095	83126	89430
19168179	G63783		19300025	49228		20955408	G64101		22012095	89430	
19168458	61643		19300034	49228		20955413	61690		22012096	83221	

**Important Note:** Competitive Interchanges are to be used for stocking purposes only. Where multiple crosses are identified, please reference the applications section of this catalog. / **Remarque importante:** Les interchanges concurrentiels ne s'utilisent qu'aux fins de stocks. Dans le cas de rfrences multiples, consulter la section des applications du catalogue. / **Nota importante:** Dans le cas de rfrences multiples, consulter la section des applications du catalogue. / **Nota importante:** Se pueden usar intercambios competitivos para propósitos de almacenamiento solamente. Cuando se identifican intercambios múltiples, consulte la sección de aplicaciones de este catálogo.

**COMPETITIVE & O.E.M. INTERCHANGE LIST**  
**Lista de Intercambios contra Competidores y Equipo Original.**  
**Liste d'interchange de produits comptitifs & d'equipement original (OEM)**

**General Motors... cont'd**

General motors	Gabriel	Upgrade	General motors	Gabriel	Upgrade	General motors	Gabriel	Upgrade	General motors	Gabriel	Upgrade
22012114	85700		22064807	83136		22811853	G51891		23156080	G57000	
22012131	85711		22064829	61543		22811854	G51891		23156080	G57023	
22012166	83126	89430	22064829	G63488		22830632	G57000		23156081	G51949	
22012166	89430		22064830	58609		22830632	G57023		23156082	G57000	
22012169	83221		22064830	61542		22862538	G52128		23156082	G57023	
22012196	83221		22064830	61544		22865484	G64140		23156090	61690	
22017530	83303		22064830	77609		22872085	G52127		23156090	G63959	
22017531	83303		22064830	G63489		22872086	G52128		23156091	61690	
22024061	85704		22064830	G63609		22891309	G57000		23156091	G63959	
22025067	85704		22064845	49213		22891309	G57023		23163342	G52279	
22025305	85704		22064855	61531		22891310	G57000		23179308	G57000	
22045526	85702		22064858	49213		22891310	G57023		23179308	G57023	
22046430	81492		22064858	61528		22891328	61690		23183580	77975	
22046476	69714		22065218	G63347		22891328	G63959		23183580	G64101	
22046481	85702		22065228	69724		22896271	61690		23183849	77975	
22046483	85304		22065228	81492		22896271	G63959		23183849	G64101	
22046489	85303	89422	22065251	85030	89440	22902421	G57109		23183850	G64101	
22046489	89422		22065251	89440		22902430	G57109		23183864	G51949	
2204683	85304		22165187	83136		22920115	143366		23183880	G57000	
22052014	85702		22165188	83136		22932447	70059		23183880	G57023	
22052336	85304		22165189	83136		22950375	G51982		23183892	G51949	
22064009	69715		22166442	83136		22969018	G52278		23216161	G63872	
22064013	61524		22181548	69898		22969019	G52279		23218793	77975	
22064013	G63349		22687770	143089		22986271	G63959		23218793	G64101	
22064019	61524		22687774	143089		23106628	G51949		23269413	G55948	
22064019	G63349		22687780	143089		23106629	G57000		23269413	G57060	
22064034	69715		22695255	G63872		23106629	G57023		23269415	G55948	
22064099	69715		22696400	69587		23106631	61690		23269415	G57060	
22064102	G56718		22698911	G52026		23106631	G63959		23269416	G55949	
22064226	61524		22698912	G52027		23106632	G63959		23269417	G55949	
22064226	G63349		22707166	G56809		23106633	61690		23275425	G57000	
22064229	69811		22707167	G56809		23106633	G63959		23275425	G57023	
22064230	83136		22712116	143354		23111833	143486		23276075	G57000	
22064232	85071		22712116	143355		23124579	61690		23276075	G57023	
22064233	83136		22716372	G57070		23124579	G63959		23338789	G57000	
22064417	61544		22716376	143354		23124580	61690		23338789	G57023	
22064417	G63489		22716376	143355		23124580	G63959		23338792	G57000	
22064432	83221		22716378	143354		23124581	61690		23338792	G57023	
22064445	81750		22716378	143355		23124581	G63959		23338796	G57000	
22064445	G63421		22737714	G52280		23124582	61690		23338796	G57023	
22064573	G55825		22737715	G52281		23124582	G63959		23338800	G57000	
22064619	61539		22737716	G52280		23124583	61690		23338800	G57023	
22064619	G63454		22737717	G52281		23124583	G63959		23338819	G57000	
22064635	58609		22737724	G51916		23124584	61690		23338819	G57023	
22064635	61542		22761744	69589		23124584	G63959		23338824	G57000	
22064635	77609		22761744	69590		23124585	61690		23338824	G57023	
22064635	G63609		22769872	G57060		23124585	G63959		23338831	G57000	
22064684	58609		22769873	G57060		23124591	G51949		23338831	G57023	
22064684	61542		22773347	G64140		23124594	G51949		23338839	G57000	
22064684	77609		22796281	G55949		23124595	G51949		23338839	G57023	
22064684	G63609		22796872	G55948		23124596	G51949		23338844	G57000	
22064776	G55698		22796873	G55948		23124598	G51949		23338844	G57023	
22064781	G56509		22809066	G51916		23130121	G51949		23338863	G57000	
22064804	83136		22811082	G57069		23130122	G51949		23338863	G57023	
22064805	83136		22811844	77975		23147603	G64040		23338867	G57000	
22064806	83136		22811844	G64101		23147604	G64040		23338867	G57023	

**Important Note:** Competitive Interchanges are to be used for stocking purposes only. Where multiple crosses are identified, please reference the applications section of this catalog. / **Remarque importante:** Les interchanges concurrentiels ne s'utilisent qu'aux fins de stocks. Dans le cas de références multiples, consulter la section des applications du catalogue. / **Nota importante:** Dans le cas de références multiples, consulter la section des applications du catalogue. / **Nota importante:** Se pueden usar intercambios competitivos para propósitos de almacenamiento solamente. Cuando se identifican intercambios múltiples, consulte la sección de aplicaciones de este catálogo.



**COMPETITIVE & O.E.M. INTERCHANGE LIST**  
**Lista de Intercambios contra Competidores y Equipo Original.**  
**Liste dinterchange de produits comptitifs & dquipement original (OEM)**

**General Motors... cont'd**

General motors	Gabriel	Upgrade	General motors	Gabriel	Upgrade	General motors	Gabriel	Upgrade	General motors	Gabriel	Upgrade
23338871	G57000		3171462	89430		4940600	83209	89414	5321920	85307	
23338871	G57023		3171696	85307		4940600	89414		5321929	85307	
23338875	G57000		3172948	85303	89422	4940601	83216		5348631	83203	89436
23338875	G57023		3172948	89422		4940606	83126	89430	5348631	89436	
23390197	G52278		3178106	85700		4940606	89430		5352857	85700	
23390198	G52279		3178157	85700		4940614	83216		5352858	85305	
23390201	G52278		3178233	85734		4940627	83203	89436	5353054	85303	89422
23425607	G57000		3178507	85700		4940627	89436		5353054	89422	
23425607	G57023		3178995	85700		4940640	83216		5355798	85307	
23452955	77975		3182842	85711		4940650	83207	89407	5357955	85300	89419
23452955	G64101		3188599	85711		4940650	89407		5357955	89419	
23452959	G57000		3188626	85300	89419	4940654	83216		5357956	85734	
23452959	G57023		3188626	89419		4940660	83207	89407	5357959	85300	89419
23455253	70059		3188729	85303	89422	4940660	89407		5357959	89419	
25805824	G52128		3188729	89422		4940662	83126	89430	5361994	85734	
25815074	143366		3189265	85700		4940662	89430		5374779	85308	89422
25820699	G63842		3192333	85700		4963844	85307		5374779	89422	
25822945	G64040		3192416	85711		4963853	83216		5374999	85307	
25831691	69590		3192657	83216		4963854	83216		5385939	85307	
25856156	143366		3192890	83126	89430	4974401	85700		5392387	85303	89422
25870984	61690		3192890	89430		4975429	85300	89419	5392387	89422	
25870984	G63959		3192891	83221		4975429	89419		5394448	85305	
25870986	61690		3192892	83221		4975467	83207	89407	5394467	85305	
25870986	G63959		35901-0001	83209	89414	4975467	89407		5455798	85307	
25870987	61690		35901-0001	89414		4975479	83400		5513489	83216	
25870987	G63959		35901-0003	85301		4975480	83400		5513716	85304	
25870990	61690		35901-0004	83219		4975494	83207	89407	5516459	85305	
25870990	G63959		35901-0005	83219		4975494	89407		5522794	85308	89422
25871019	61690		35901-0017	83314		4975497	83126	89430	5522794	89422	
25871019	G63959		359010001	83209	89414	4975497	89430		5522818	85305	
25871023	61690		359010001	89414		4975501	85700		5527001	85300	89419
25871023	G63959		359010003	85301		4975510	83221		5527001	89419	
25871025	61690		359010004	83219		4975511	83303		5527271	85700	
25871025	G63959		359010005	83219		4975516	85702		5527272	85700	
25871036	61690		359010017	83314		4975518	85704		5527606	85305	
25871036	G63959		37301-0016	85026		4975538	85700		5531027	85301	
25871225	49235		37301-0021	85026		4975549	83216		5531435	85307	
25871225	61675		37301-3202	85026		4975550	85702		5531436	85307	
25871225	G63866		373010016	85026		4975552	85711		5531437	85307	
25871229	49235		373010021	85026		4984526	83216		5532026	85304	
25871229	61675		373013202	85026		4993599	6804SE		5532425	83207	89407
25871229	G63866		3989717C1	83135		507-16	85702		5532425	89407	
25874561	143366		4089293C1	83397		507-19	85700		5532433	83207	89407
25875709	142526		4109458C2	83243		507-3	85307		5532433	89407	
25948611	43181		4109582C1	83397		50716	85702		5532675	85307	
25978183	G64040		4109583C1	83397		50719	85700		5533699	85302	89420
25980102	G51870		4206863C1	83398		5073	85307		5533699	89420	
25984611	61600		4207304C1	83397		508-86	83136		5534430	85303	89422
25984613	58412		4208946C1	83398		50886	83136		5534430	89422	
25984613	61642		4214011C2	85670		5171068	83216		5534439	85304	
25984613	77412		42417188	G52494		5304059	85700		5534447	85303	89422
3082284	83400		42417189	G52495		5316784	85700		5534447	89422	
3166657	85700		4939852	85308	89422	5316791	83219		5544060	85302	89420
3171068	83216		4939852	89422		5316792	85305		5544060	89420	
3171069	85304		4939967	85308	89422	5316793	85305		5544112	83216	
3171462	83126	89430	4939967	89422		5316794	85700		5544581	85302	89420

**Important Note:** Competitive Interchanges are to be used for stocking purposes only. Where multiple crosses are identified, please reference the applications section of this catalog. / **Remarque importante:** Les interchanges concurrentiels ne s'utilisent qu'aux fins de stocks. Dans le cas de rferences multiples, consulter la section des applications du catalogue. / **Nota importante:** Dans le cas de rferences multiples, consulter la section des applications du catalogue. / **Nota importante:** Se pueden usar intercambios competitivos para propósitos de almacenamiento solamente. Cuando se identifican intercambios múltiples, consulte la sección de aplicaciones de este catálogo.

**COMPETITIVE & O.E.M. INTERCHANGE LIST**  
**Lista de Intercambios contra Competidores y Equipo Original.**  
**Liste d'interchange de produits complitifs & d'equipement original (OEM)**

**General Motors... cont'd**

General motors	Gabriel	Upgrade	General motors	Gabriel	Upgrade	General motors	Gabriel	Upgrade	General motors	Gabriel	Upgrade
5544581	89420		84043175	G57000		88945997	81270		88946216	82601	
5544716	85304		84043175	G57023		88945999	81340		88946217	82602	
5544717	85304		84043190	G57000		88946002	81394		88946223	82609	
5544812	83308		84043190	G57023		88946009	81510		88946231	82618	
5549899	83207	89407	84043200	G57000		88946010	81082		88946316	142249	
5549899	89407		84043200	G57023		88946013	69675		88946326	143204	
5549924	85700		84043205	G57000		88946013	81446		88946421	142526	
5549925	85304		84043205	G57023		88946020	81478		88946426	142530	
5552111	85304		84059852	G57000		88946021	81482		88946443	142547	
5552112	85307		84059852	G57023		88946022	81481		88946452	142836	
5552114	83216		84061228	G57000		88946023	81490		88946547	14017	
5552206	83214		84061228	G57023		88946024	81494		88946548	14018	
5552209	83215		84082002	G57000		88946025	81492		88946552	14040	
5552210	85308	89422	84082002	G57023		88946027	81495		88946553	34036	
5552210	89422		84082031	G57000		88946028	81496		88946554	34051	
5552244	85308	89422	84082031	G57023		88946029	81484		88946556	34057	
5552244	89422		84129872	G64140		88946031	81507		88946558	34073	
5552285	83214		84176631	G57000		88946032	81514		88946561	43048	
5552451	85308	89422	84176631	G57023		88946033	81516		88946562	43049	
5552451	89422		84192068	G64140		88946039	81540		88946564	43060	
5552452	85303	89422	84303234	G63895		88946041	81548		88946564	49152	
5552452	89422		87-2520-00003	85704		88946042	81549		88946574	43111	
5552453	85301		87252000003	85704		88946044	81553		88946580	43162	
5552454	85302	89420	88945169	69600		88946050	81559		88946581	43163	
5552454	89420		88945170	49334		88946051	81560		88946588	43180	
5552456	85307		88945170	69604		88946055	81582		88946589	43181	
5552552	85303	89422	88945171	69606		88946059	81667		88946592	49107	
5552552	89422		88945172	69622		88946060	81668		88946595	49122	
5554184	85302	89420	88945173	69624		88946065	81675		88946597	49128	
5554184	89420		88945174	69632		88946072	81713		88946598	49131	
5554589	85307		88945177	69675		88946083	81750		88946599	49135	
5554596	85303	89422	88945178	69676		88946106	82003		88946603	49152	
5554596	89422		88945184	69715		88946113	82010		88946604	49155	
5554814	85302	89420	88945185	69714		88946129	82026		88946605	49157	
5554814	89420		88945188	69724		88946137	82034		88946607	49162	
5554959	83401		88945188	81514		88946138	82035		88946618	49203	
5554995	85305		88945194	69725		88946142	82039		88946621	49212	
5559363	83203	89436	88945205	69795		88946143	82040		88946622	43162	
5559363	89436		88945210	69811		88946145	82047		88946622	49213	
5585939	85307		88945324	34051		88946149	82051		88946624	49215	
684280	83209	89414	88945324	81494		88946155	82060		88946627	49218	
684280	89414		88945325	69715		88946164	82070		88946635	49228	
8-51630-666-0	85012	89413	88945344	61539		88946168	82075		88946635	49255	
8-51630-666-0	89413		88945344	G63454		88946169	82076		88946637	49230	
8-94057-593-0	83114		88945846	61500		88946171	82079		88946638	49231	
8-94454-986-0	83515		88945847	61501		88946176	82086		88946642	49235	
8-94454-987-0	83515		88945854	61508		88946177	82087		88946647	49304	
8-97083-029-0	83515		88945861	61516		88946182	82099		88946652	49311	
8-97201-960-0	83515		88945867	61522		88946188	82109		88946654	49334	
8-97253-620-0	83515		88945983	81039		88946189	82110		88946669	6801SE	
8-97253664-0	83159		88945986	81095		88946195	82118		88946670	6802SE	
8-97253665-0	83159		88945987	81096		88946198	82125		88946671	6803SE	
8-98380-746-0	83159		88945990	81113		88946205	82138		88946672	6804SE	
8-98380-747-0	83159		88945991	81164		88946210	82151		88947653	69625	
8-98381-010-0	83515		88945992	81147		88946214	82155		88955457	49228	
8-98381-012-0	83515		88945995	81242		88946215	82156		88955457	49255	

**Important Note:** Competitive Interchanges are to be used for stocking purposes only. Where multiple crosses are identified, please reference the applications section of this catalog. / **Remarque importante:** Les interchanges concurrentiels ne s'utilisent qu'aux fins de stocks. Dans le cas de rferences multiples, consulter la section des applications du catalogue. / **Nota importante:** Dans le cas de rferences multiples, consulter la section des applications du catalogue. / **Nota importante:** Se pueden usar intercambios competitivos para propósitos de almacenamiento solamente. Cuando se identifican intercambios múltiples, consulte la sección de aplicaciones de este catálogo.

**COMPETITIVE & O.E.M. INTERCHANGE LIST**  
**Lista de Intercambios contra Competidores y Equipo Original.**  
**Liste dinterchange de produits comptitifs & dquipement original (OEM)**

**General Motors... cont'd**

General motors	Gabriel	Upgrade	General motors	Gabriel	Upgrade	General motors	Gabriel	Upgrade	General motors	Gabriel	Upgrade
88955458	49228		88966782	61531		89038654	43181		94859874	G55662	
88955458	49255		88966786	61535		89038654	61600		94859875	G55661	
88955460	49228		88966787	61536		89040176	G57000		95015324	143239	
88955460	49255		88966789	61539		89040176	G57023		9516306471	83515	
88955461	49228		88966791	61541		89040177	61643		9516306660	85012	89413
88955461	49255		88966792	61542		89040177	G63803		9516306660	89413	
88959113	58357		88966793	61543		89060253	143363		9516306662	85012	89413
88959123	58403		88966794	61544		8940575930	83114		9516306662	89413	
88959128	58412		88966801	61555		8944549860	83515		95266854	G52495	
88959132	58421		88966805	61560		8944549870	83515		95266855	G52494	
88959133	58422		88966809	61600		8970830290	83515		95266856	G52495	
88959134	58423		88966810	61565		8972019600	83515		95266857	G52494	
88959140	58488		88966813	61575		8972536200	83515		95271437	G511030	
88959141	58489		88966837	61615		8972536640	83159		95271438	G511030	
88959143	58609		88966838	61616		8972536650	83159		95387906	G511030	
88959149	58638		88966850	61641		898098-0580	83159		95440469	G52495	
88959151	58662		88966851	61642		898098-0581	83159		95440470	G52494	
88959156	58714		88966852	61643		898098-0590	83159		95440471	G52495	
88959162	58901		88966862	61659		898098-1250	83515		95440472	G52494	
88959166	58803		88966866	61663		898098-1270	83515		95440473	G511030	
88959173	58817		88966868	61664		8980980580	83159		96980824	G57130	
88961944	69464		88966869	61605		8980980581	83159		96980825	G57131	
88961947	81869		88974638	G51736		8980980590	83159		96980826	G57130	
88962978	75676		88982682	83136		8980981250	83515		96980827	G57131	
88962985	77403		88982684	83136		8980981270	83515		97-2210-00156	85702	
88962987	77375		88982686	85071		8983807460	83159		97-2210-00164	85708	
88962995	77412		88983816	58803		8983807470	83159		97-2210-00170	85733	
88962995	77783		88983816	77803		8983810100	83515		97083027	83515	
88963000	77422		88983818	49235		8983810120	83515		97083029	83515	
88963001	77423		88983818	61675		9-51630-647-1	83515		97201960	83515	
88963004	77454		88983818	G63866		9-51630-666-0	85012	89413	97221000156	85702	
88963009	77488		88985556	142561		9-51630-666-0	89413		97221000164	85708	
88963010	77488		88986629	61555		9-51630-666-2	85012	89413	97221000170	85733	
88963010	77489		88986629	81713		9-51630-666-2	89413		97253616	83515	
88963017	77609		88986629	G63375		90251921	143459		97253620	83515	
88963020	77638		89038500	61643		92195484	G51916		97253621	83515	
88963023	77662		89038500	G63803		92195485	G51916		97253623	83515	
88963039	77783		89038591	61642		92213101	143461		97253651	83159	
88963040	77803		89038595	58803		92213102	143462		97253664	83159	
88963046	77817		89038595	61641		92233769	143462		97253665	83159	
88963054	77907		89038595	61643		92244056	G52281		98098058	83159	
88963055	77909		89038595	77803		92244057	G52280		98098059	83159	
88963949	69622		89038595	G63783		92244058	G52281		98098125	83515	
88963949	81880		89038595	G63803		92244059	G52280		98098127	83515	
88964326	143323		89038596	61690		94033786	83114		98232671	83515	
88965467	G55948		89038596	G63959		94051090	83114		98380746	83159	
88965469	G55949		89038597	58412		94057593	83114		98380747	83159	
88966763	61504		89038597	77412		94454987	83515		98381010	83515	
88966765	61506		89038652	58803		94849261	143281		98381012	83515	
88966771	61517		89038652	58817		94849262	143281		SG23086	61522	
88966773	61519		89038652	61663		94854736	143281		U0109-014	83400	
88966777	61524		89038652	77803		94857922	143281		U0109014	83400	
88966778	61525		89038652	77817		94857975	G55999				
88966780	61528		89038652	G63817		94857976	G55999				

**Important Note:** Competitive Interchanges are to be used for stocking purposes only. Where multiple crosses are identified, please reference the applications section of this catalog. / **Remarque importante:** Les interchanges concurrentiels ne s'utilisent qu'aux fins de stocks. Dans le cas de rfrences multiples, consulter la section des applications du catalogue. / **Nota importante:** Dans le cas de rfrences multiples, consulter la section des applications du catalogue. / **Nota importante:** Se pueden usar intercambios competitivos para propósitos de almacenamiento solamente. Cuando se identifican intercambios múltiples, consulte la sección de aplicaciones de este catálogo.

**COMPETITIVE & O.E.M. INTERCHANGE LIST**  
**Lista de Intercambios contra Competidores y Equipo Original.**  
**Liste dinterchange de produits comptitifs & dquipement original (OEM)**

General Trailer Co.											
General trailer co.	Gabriel	Upgrade	General trailer co.	Gabriel	Upgrade	General trailer co.	Gabriel	Upgrade	General trailer co.	Gabriel	Upgrade
120-1	83125		1201	83125		12608	83125				

Georgie Boy Manufacturing											
Georgie boy manufacturing	Gabriel	Upgrade	Georgie boy manufacturing	Gabriel	Upgrade	Georgie boy manufacturing	Gabriel	Upgrade	Georgie boy manufacturing	Gabriel	Upgrade
10-12390-000	85920	89503	1C3418045JA	83209	89414	9U9418080AA	89406		ASH1161	85006	
10-12390-000	89503		1C3418045JA	89414		9U9Z-18124-A	83209	89414	ASH1162	85005	89430
10-13021-000	85918	89449	22064230	83136		9U9Z-18124-A	89414		ASH1162	89430	
10-13021-000	89449		3578858C1	85656		9U9Z-18125-A	83122	89406	ASH1205	83209	89414
10-13063-000	85918	89449	3578858C2	85656		9U9Z-18125-A	89406		ASH1205	89414	
10-13063-000	89449		3584116C1	83175		9U9Z18124A	83209	89414	ASH1206	83122	89406
10-13211-000	85918	89449	3584116C2	83175		9U9Z18124A	89414		ASH1206	89406	
10-13211-000	89449		3584118C2	85928		9U9Z18125A	83122	89406	ASH1228	83209	89414
10-13634-000	85918	89449	471700000449	85918	89449	9U9Z18125A	89406		ASH1228	89414	
10-13634-000	89449		471700000449	89449		AA-616	83175		ASH1229	83209	89414
10-13684-000	85918	89449	471700002808	85724	89443	AA-617	85928		ASH1229	89414	
10-13684-000	89449		471700002808	89443		AA616	83175		ASH1230	83122	89406
10-13760-000	85959		471700002809	85724	89443	AA617	85928		ASH1230	89406	
10-13809-000	85958		471700002809	89443		ASH-1022	83209	89414	ASH137	83122	89406
1012390000	85920	89503	471700002991	85959		ASH-1022	89414		ASH137	89406	
1012390000	89503		471700003920	85958		ASH-1023	83122	89406	ASH24658	85181	
1013021000	85918	89449	471700011530	85181		ASH-1023	89406		ASH24659	85181	
1013021000	89449		471700011531	85180		ASH-1136	G63623		ASH24660	85180	
1013063000	85918	89449	471700131155	85918	89449	ASH-1154	G63622		ASH24661	83317	
1013063000	89449		471700131155	89449		ASH-1161	85006		ASH25820	85005	89430
1013211000	85918	89449	481700000493	85900		ASH-1162	85005	89430	ASH25820	89430	
1013211000	89449		481700006848	85724	89443	ASH-1162	89430		ASH25821	85006	
1013634000	85918	89449	481700006848	89443		ASH-1205	83209	89414	ASH25822	83209	89414
1013634000	89449		4C4Z-18124-JB	85928		ASH-1205	89414		ASH25822	89414	
1013684000	85918	89449	4C4Z-18124-QA	83175		ASH-1206	83122	89406	ASH25823	83209	89414
1013684000	89449		4C4Z-18124-RA	85928		ASH-1206	89406		ASH25823	89414	
1013760000	85959		4C4Z-18125-B	83317		ASH-1228	83209	89414	ASH25824	83122	89406
1013809000	85958		4C4Z-18125-DA	85656		ASH-1228	89414		ASH25824	89406	
141700131809	85029		4C4Z18124JB	85928		ASH-1229	83209	89414	ASH294	83209	89414
141700131810	83160		4C4Z18124QA	83175		ASH-1229	89414		ASH294	89414	
16-15817-000	85724	89443	4C4Z18124RA	85928		ASH-1230	83122	89406	AT-163G	G63622	
16-15817-000	89443		4C4Z18125DA	85656		ASH-1230	89406		AT-164G	G63623	
16-16736-000	85029		501906C92	83317		ASH-137	83122	89406	AT-620	83209	89414
16-16737-000	83160		66153-002	83124	89407	ASH-137	89406		AT-620	89414	
16-16873-000	85029		66153-002	89407		ASH-24658	85181		AT-621	83122	89406
16-16874-000	83160		66153002	83124	89407	ASH-24659	85181		AT-621	89406	
16-18103-000	85900		66153002	89407		ASH-24660	85180		AT-766	83209	89414
16-18708-000	85724	89443	680611	85724	89443	ASH-25820	85005	89430	AT-766	89414	
16-18708-000	89443		680611	89443		ASH-25820	89430		AT-812	85928	
1615817000	85724	89443	8C24-18045-DA	G63622		ASH-25821	85006		AT163G	G63622	
1615817000	89443		8C24-18080-DB	G63623		ASH-25822	83209	89414	AT164G	G63623	
1616736000	85029		8C2418045DA	G63622		ASH-25822	89414		AT620	83209	89414
1616737000	83160		8C2418080DB	G63623		ASH-25823	83209	89414	AT620	89414	
1616873000	85029		8C2Z-18124-D	G63622		ASH-25823	89414		AT621	83122	89406
1616874000	83160		8C2Z-18125-D	G63623		ASH-25824	83122	89406	AT621	89406	
1618103000	85900		8C2Z18124D	G63622		ASH-25824	89406		AT766	83209	89414
1618708000	85724	89443	8C2Z18125D	G63623		ASH-294	83209	89414	AT766	89414	
1618708000	89443		9U94-18045-AA	83209	89414	ASH-294	89414		AT812	85928	
1C34-18045-AA	83209	89414	9U94-18045-AA	89414		ASH1022	83209	89414	F4-BE5-C832-MO	83124	89407
1C34-18045-AA	89414		9U94-18080-AA	83122	89406	ASH1022	89414		F4-BE5-C832-MO	89407	
1C34-18045-JA	83209	89414	9U94-18080-AA	89406		ASH1023	83122	89406			
1C34-18045-JA	89414		9U9418045AA	83209	89414	ASH1023	89406				
1C3418045AA	83209	89414	9U9418045AA	89414		ASH1136	G63623				
1C3418045AA	89414		9U9418080AA	83122	89406	ASH1154	G63622				

**Important Note:** Competitive Interchanges are to be used for stocking purposes only. Where multiple crosses are identified, please reference the applications section of this catalog. / **Remarque importante:** Les interchanges concurrentiels ne s'utilisent qu'aux fins de stocks. Dans le cas de rferences multiples, consulter la section des applications du catalogue. / **Nota importante:** Dans le cas de rferences multiples, consulter la section des applications du catalogue. / **Nota importante:** Se pueden usar intercambios competitivos para propósitos de almacenamiento solamente. Cuando se identifican intercambios múltiples, consulte la sección de aplicaciones de este catálogo.

**COMPETITIVE & O.E.M. INTERCHANGE LIST**  
**Lista de Intercambios contra Competidores y Equipo Original.**  
**Liste dinterchange de produits comptitifs & dquipement original (OEM)**

**Georgie Boy Manufacturing... cont'd**

Georgie boy manufacturing	Gabriel	Upgrade	Georgie boy manufacturing	Gabriel	Upgrade	Georgie boy manufacturing	Gabriel	Upgrade	Georgie boy manufacturing	Gabriel	Upgrade
F4BE5C832MO	83124	89407	FC4418045BB	85181		FC4Z-18125-A	85180		SDA471700002809	85724	89443
F4BE5C832MO	89407		FC4418080AB	85180		FC4Z18124A	85181		SDA471700002809	89443	
FC44-18045-BB	85181		FC4Z-18124-A	85181		FC4Z18124B	85181		SDA471700002991	85959	
FC44-18080-AB	85180		FC4Z-18124-B	85181		FC4Z18125A	85180		SDA471700003920	85958	

**Gillig Bros.**

Gillig bros.	Gabriel	Upgrade	Gillig bros.	Gabriel	Upgrade	Gillig bros.	Gabriel	Upgrade	Gillig bros.	Gabriel	Upgrade
1145291N000	85916	89430	5314010	85318		82-30159-000	85708		90044770	83207	89407
1145291N000	89430		53176	85304		8201878	83122	89406	90044770	89407	
1583470	85051		5324685	85723		8201878	89406		901908	85723	
200-171	85304		57113	83219		8221542000	85716		901951SP1	85734	
200171	85304		57131	83216		8230159000	85708		901968	85712	
53-02132	85723		665568	85051		90-1908	85723		902164 SP1	85723	
53-02133-000	85318		680009	85302	89420	90-1951-SP1	85734		902423	85723	
53-13952-000	85722		680009	89420		90-1968	85712		9051024	85916	89430
53-14005-000	85723		680333	85708		90-2164 SP1	85723		9051024	89430	
53-14010	85318		695109	85723		90-2423	85723		90F-1912	85318	
53-176	85304		695110	85318		90044046	83123	89405	90F1912	85318	
53-24685	85723		70034	85302	89420	90044046	89405		H53-02132-14005	85723	
5302132	85723		70034	89420		90044683	83122	89406	H53-20415-006	85051	
5302133000	85318		82-01878	83122	89406	90044683	89406		H530213214005	85723	
5313952000	85722		82-01878	89406		90044769	83207	89407	H5320415006	85051	
5314005000	85723		82-21542-000	85716		90044769	89407		MR6394	85723	

**Glaval Bus Co.**

Glaval bus co.	Gabriel	Upgrade	Glaval bus co.	Gabriel	Upgrade	Glaval bus co.	Gabriel	Upgrade	Glaval bus co.	Gabriel	Upgrade
3578858C1	85656		4C4Z-18125-DA	85656		ASH-1154	G63622		FC44-18080-AB	85180	
3578858C2	85656		4C4Z18124JB	85928		ASH-24658	85181		FC4418045BB	85181	
3584116C1	83175		4C4Z18124QA	83175		ASH-24659	85181		FC4418080AB	85180	
3584116C2	83175		4C4Z18124RA	85928		ASH-24660	85180		FC4Z-18124-A	85181	
3584118C2	85928		4C4Z18125DA	85656		ASH24658	85181		FC4Z-18124-B	85181	
471700011530	85181		501906C92	83317		ASH24659	85181		FC4Z-18125-A	85180	
471700011531	85180		AA-616	83175		ASH24660	85180		FC4Z18124A	85181	
4C4Z-18124-JB	85928		AA-617	85928		ASH24661	83317		FC4Z18124B	85181	
4C4Z-18124-QA	83175		AA616	83175		AT-812	85928		FC4Z18125A	85180	
4C4Z-18124-RA	85928		AA617	85928		AT812	85928				
4C4Z-18125-B	83317		ASH-1136	G63623		FC44-18045-BB	85181				

**GMC**

Gmc	Gabriel	Upgrade	Gmc	Gabriel	Upgrade	Gmc	Gabriel	Upgrade	Gmc	Gabriel	Upgrade
1-51630-217-0	83114		22002293	83126	89430	22012196	83221		3171069	85304	
1-51630-217-1	83114		22002293	89430		22017530	83303		3171462	83126	89430
1-51630-219-1	83114		22002295	83303		22017531	83303		3171462	89430	
1202-0012	83023		22007701	83126	89430	22046483	85304		3178106	85700	
1202-0032	83016		22007701	89430		22052336	85304		3178507	85700	
12020012	83023		22007750	83207	89407	22064230	83136		3178995	85700	
12020032	83016		22007750	89407		22064232	85071		3182842	85711	
12474915	83122	89406	22007751	83303		22064233	83136		3188599	85711	
12474915	89406		22007753	83303		22064432	83221		3189265	85700	
15123676	83136		22012065	85304		22064804	83136		3192333	85700	
1516302170	83114		22012090	85308	89422	22064805	83136		3192416	85711	
1516302171	83114		22012090	89422		22064806	83136		3192657	83216	
1516302191	83114		22012091	85303	89422	22064807	83136		3192890	83126	89430
15174898	83136		22012091	89422		22165187	83136		3192890	89430	
15174902	85071		22012095	83126	89430	22165188	83136		3192891	83221	
15588554	83136		22012095	89430		22165189	83136		3192892	83221	
15887728	83136		22012096	83221		22166442	83136				
15963161	83122	89406	22012166	83126	89430	3082284	83400				
15963161	89406		22012166	89430		3166657	85700				
19152843	83136		22012169	83221		3171068	83216				

**Important Note:** Competitive Interchanges are to be used for stocking purposes only. Where multiple crosses are identified, please reference the applications section of this catalog. / **Remarque importante:** Les interchanges concurrentiels ne s'utilisent qu'aux fins de stocks. Dans le cas de rfrences multiples, consulter la section des applications du catalogue. / **Nota importante:** Dans le cas de rfrences multiples, consultar la section des aplicaciones du catalogue. / **Nota importante:** Se pueden usar intercambios competitivos para propósitos de almacenamiento solamente. Cuando se identifican intercambios múltiples, consulte la sección de aplicaciones de este catálogo.

**COMPETITIVE & O.E.M. INTERCHANGE LIST**  
**Lista de Intercambios contra Competidores y Equipo Original.**  
**Liste d'interchange de produits complitifs & d'equipement original (OEM)**

**GMC... cont'd**

Gmc	Gabriel	Upgrade	Gmc	Gabriel	Upgrade	Gmc	Gabriel	Upgrade	Gmc	Gabriel	Upgrade
35901-0005	83219		4975497	89430		5552456	85307		8980980590	83159	
359010005	83219		4975510	83221		8-94057-593-0	83114		8980981250	83515	
37301-0016	85026		4975511	83303		8-97083-029-0	83515		8980981270	83515	
37301-0021	85026		4975552	85711		8-97201-960-0	83515		94033786	83114	
37301-3202	85026		4984526	83216		8-97253664-0	83159		94051090	83114	
373010016	85026		5304059	85700		8-97253665-0	83159		94057593	83114	
373010021	85026		5316784	85700		88982682	83136		94454987	83515	
373013202	85026		5316794	85700		88982686	85071		97201960	83515	
4940600	83209	89414	5352857	85700		8940575930	83114		97253616	83515	
4940600	89414		5527271	85700		8970830290	83515		97253621	83515	
4940606	83126	89430	5527272	85700		8972019600	83515		97253623	83515	
4940606	89430		5544060	85302	89420	8972536640	83159		97253651	83159	
4940614	83216		5544060	89420		8972536650	83159		97253664	83159	
4963853	83216		5549924	85700		898098-0580	83159		97253665	83159	
4963854	83216		5552451	85308	89422	898098-0581	83159		98098058	83159	
4975467	83207	89407	5552451	89422		898098-0590	83159		98098059	83159	
4975467	89407		5552452	85303	89422	898098-1250	83515		98098125	83515	
4975494	83207	89407	5552452	89422		898098-1270	83515		98098127	83515	
4975494	89407		5552454	85302	89420	8980980580	83159				
4975497	83126	89430	5552454	89420		8980980581	83159				

**Gold**

Gold	Gabriel	Upgrade	Gold	Gabriel	Upgrade	Gold	Gabriel	Upgrade	Gold	Gabriel	Upgrade
5000736	83039		5000784	85080		5000844	83030		8160101	85001	89410
5000738	85071		5000785	83216		5000849	85054		8160101	89410	
5000740	83105		5000786	83103		5000850	83053		8160102	83215	
5000741	83136		5000787	85938		5000852	85376		8160103	83312	89409
5000742	83308		5000789	83110		5000853	83101		8160103	89409	
5000743	83107		5000790	83180		5000855	83154		8160111	85066	89448
5000744	85090		5000791	83157		5000856	85978		8160111	89448	
5000745	83314		5000792	83134		5000857	85929		8160112	85061	89450
5000745	85013	89414	5000793	83400		5000859	83031		8160113	85931	89458
5000745	89414		5000796	632147		5000861	83025		8160113	89458	
5000747	83101		5000797	85307		5000862	83140		8160114	85918	89449
5000748	83135		5000798	85712		5000865	85910		8160114	89449	
5000749	85308	89422	5000799	85711		5000869	83216		8160115	85031	
5000749	89422		5000800	85736		5000870	83022		8160116	85012	89413
5000750	83035		5000802	85341		5000871	83164		8160116	89413	
5000751	85055	89439	5000804	85308	89422	5000872	85082		8160118	85900	
5000751	89439		5000804	89422		5000877	85722		8160119	85902	
5000754	83015		5000806	83027		5000879	85970		8160120	85069	89455
5000758	85055	89439	5000807	85343		5000880	85711		8160120	89455	
5000758	89439		5000808	85916	89430	5000881	85736		8160189	85937	
5000759	83142		5000808	89430		8150240	83125		8160195	85013	89414
5000760	85934		5000809	83635		8150241	83207	89407	8160195	85043	
5000761	85024		5000813	83221		8150241	89407		8160195	89414	
5000762	83160		5000816	85956		8150242	83128	89436	8160522	83029	
5000764	85957		5000818	83120		8150242	89436		8160523	83021	
5000765	83216		5000822	83004		8150243	83009		8160848	85088	
5000768	83401		5000825	83225		8150371	83127		8160849	83051	
5000773	85065		5000826	85029		8150372	83137		8160906	83147	
5000776	85005	89430	5000827	85908		8160090	85000	89436	8160907	85036	89405
5000776	89430		5000828	83044		8160090	89436		8160907	89405	
5000777	83143		5000830	83175		8160091	85006		8160908	83019	
5000778	83054		5000831	83024		8160098	83456	89447			
5000781	85656		5000835	83150		8160098	89447				
5000782	83017		5000839	83131		8160099	83318				
5000783	83025		5000840	83162		8160100	85052				

**Important Note:** Competitive Interchanges are to be used for stocking purposes only. Where multiple crosses are identified, please reference the applications section of this catalog. / **Remarque importante:** Les interchanges concurrentiels ne s'utilisent qu'aux fins de stocks. Dans le cas de rferences multiples, consulter la section des applications du catalogue. / **Nota importante:** Dans le cas de rferences multiples, consulter la section des applications du catalogue. / **Nota importante:** Se pueden usar intercambios competitivos para propósitos de almacenamiento solamente. Cuando se identifican intercambios múltiples, consulte la sección de aplicaciones de este catálogo.



**COMPETITIVE & O.E.M. INTERCHANGE LIST**  
**Lista de Intercambios contra Competidores y Equipo Original.**  
**Liste d'interchange de produits compititifs & d'equipement original (OEM)**

**Gold... cont'd**

Gold	Gabriel	Upgrade	Gold	Gabriel	Upgrade	Gold	Gabriel	Upgrade	Gold	Gabriel	Upgrade
8160909	83123	89405	9160097	85001	89410	9160933	89414		9180149	85900	
8160909	89405		9160097	89410		9160934	83047		9180151	85070	89459
8160910	83050		9160117	85320	89429	9160936	83048		9180151	89459	
8160911	83041		9160117	89429		9160972	83025		9180152	85003	89411
8160912	83001		9160121	85067	89451	9160976	83053		9180152	89411	
8160935	83140		9160121	89451		9160980	83135		9180153	85931	89458
8160938	85062	89408	9160190	85070	89459	9160983	83112		9180153	89458	
8160938	89408		9160190	89459		9170007	85918	89449	9180184	83163	
8170098	85045		9160268	85058	89431	9170007	89449		9180186	85933	89454
8180050	85001	89410	9160268	89431		9180126	85012	89413	9180186	89454	
8180050	89410		9160470	83124	89407	9180126	89413		9180187	85084	89460
8180139	85936	89456	9160470	89407		9180130	85005	89430	9180187	89460	
8180139	89456		9160488	83456	89447	9180130	89430		9180188	85069	89455
8180171	85958		9160488	89447		9180131	85001	89410	9180188	89455	
8180172	85919		9160493	83136		9180131	89410		9180190	85072	
8180173	85954		9160498	83136		9180134	85921		9180191	85053	89442
8190008	85320	89429	9160500	85000	89436	9180136	83128	89436	9180191	89442	
8190008	89429		9160500	89436		9180136	89436		9180192	85026	
8190076	85300	89419	9160513	85029		9180137	85924	89457	9180193	85030	89440
8190076	89419		9160536	85005	89430	9180137	89457		9180193	89440	
8190087	85738		9160536	89430		9180138	85954		9180194	85014	
8190096	85729		9160538	85045		9180140	85061	89450	9180195	83111	
8190097	85727		9160539	83203	89436	9180142	85323	89436	9180196	83122	89406
9150063	83216		9160539	89436		9180142	89436		9180196	89406	
9150639	83009		9160540	85052		9180143	85918	89449	9180197	85046	89434
9160091	85006		9160545	83154		9180143	89449		9180197	89434	
9160092	85043		9160546	83008		9180144	85303	89422	9180198	85901	
9160093	83317		9160547	83001		9180144	89422		9180199	85301	
9160094	85003	89411	9160697	G63622		9180145	85067	89451	9190007	85724	89443
9160094	89411		9160761	G63461		9180145	89451		9190007	89443	
9160095	85062	89408	9160789	G63866		9180146	85033	89427	9450993	646155	
9160095	89408		9160820	83312	89409	9180146	89427				
9160096	85001	89410	9160820	89409		9180147	83136				
9160096	89410		9160933	83209	89414	9180148	85064				

**Goshen Coach**

Goshen coach	Gabriel	Upgrade	Goshen coach	Gabriel	Upgrade	Goshen coach	Gabriel	Upgrade	Goshen coach	Gabriel	Upgrade
ASH-1136	G63623		ASH-1154	G63622		ASH1136	G63623		ASH1154	G63622	

**Granning Suspension**

Granning suspension	Gabriel	Upgrade	Granning suspension	Gabriel	Upgrade	Granning suspension	Gabriel	Upgrade	Granning suspension	Gabriel	Upgrade
1085	83214		1288702	89414		17358-01	89430		18164-01	89406	
12885-01	85300	89419	16230-01	85702		1735801	83126	89430	1816401	83122	89406
12885-01	89419		1623001	85702		1735801	89430		1816401	89406	
12885-03	85300	89419	16725-01	83126	89430	17403-01	83122	89406	18165-01	85006	
12885-03	89419		16725-01	89430		17403-01	89406		1816501	85006	
1288501	85300	89419	1672501	83126	89430	1740301	83122	89406	18166-01	85704	
1288501	89419		1672501	89430		1740301	89406		1816601	85704	
1288503	85300	89419	16824-01	85006		17408-01	85005	89430	18800-01	83203	89436
1288503	89419		1682401	85006		17408-01	89430		18800-01	89436	
12886-01	85334		17142-01	85001	89410	1740801	85005	89430	1880001	83203	89436
1288601	85334		17142-01	89410		1740801	89430		1880001	89436	
12887-01	85013	89414	1714201	85001	89410	17794-01	83215		19495-01	83126	89430
12887-01	89414		1714201	89410		1779401	83215		19495-01	89430	
12887-02	85013	89414	17146-01	83209	89414	18163-01	83207	89407	1949501	83126	89430
12887-02	89414		17146-01	89414		18163-01	89407				
1288701	85013	89414	1714601	83209	89414	1816301	83207	89407			
1288701	89414		1714601	89414		1816301	89407				
1288702	85013	89414	17358-01	83126	89430	18164-01	83122	89406			

**Important Note:** Competitive Interchanges are to be used for stocking purposes only. Where multiple crosses are identified, please reference the applications section of this catalog. / **Remarque importante:** Les interchanges concurrentiels ne s'utilisent qu'aux fins de stocks. Dans le cas de rferences multiples, consulter la section des applications du catalogue. / **Nota importante:** En el caso de rferencias mltiples, consultar la seccion de aplicaciones del catalogo. / **Nota importante:** Se pueden usar intercambios competitivos para propósitos de almacenamiento solamente. Cuando se identifican intercambios mltiples, consulte la seccion de aplicaciones de este catalogo.

**COMPETITIVE & O.E.M. INTERCHANGE LIST**  
**Lista de Intercambios contra Competidores y Equipo Original.**  
**Liste d'interchange de produits compétitifs & d'équipement original (OEM)**

**Granning Suspension... cont'd**

Granning suspension	Gabriel	Upgrade	Granning suspension	Gabriel	Upgrade	Granning suspension	Gabriel	Upgrade	Granning suspension	Gabriel	Upgrade
1949501	89430		21310-01	85307		2439201	85051		700098-03	85052	
19623-01	83123	89405	2131001	85307		2697	85712		70009801	83128	89436
19623-01	89405		21497-01	85005	89430	665748	85086		70009801	89436	
1962301	83123	89405	21497-01	89430		665813	85051		70009803	85052	
1962301	89405		2149701	85005	89430	665830	85045		701071-01	646155	
19824-01	85006		2149701	89430		665833	85052		701071-01	665937	
1982401	85006		22062-01	85007		671707	85323	89436	702135-01	85045	
20125-01	85030	89440	2206201	85007		671707	89436		70213501	85045	
20125-01	89440		23523-01	85086		680162	85300	89419	702136-01	85052	
2012501	85030	89440	2352301	85086		680162	89419		70213601	85052	
2012501	89440		23524-01	85738		680551	85738		702209-01	85014	
20129-01	85007		2352401	85738		680552	85938		70220901	85014	
2012901	85007		23553-01	85938		680700	85938		704672-01	85938	
20960-01	83204		2355301	85938		700098-01	83128	89436	70467201	85938	
2096001	83204		24392-01	85051		700098-01	89436		OE12425	83214	

**Great Dane Trailer**

Great dane trailer	Gabriel	Upgrade	Great dane trailer	Gabriel	Upgrade	Great dane trailer	Gabriel	Upgrade	Great dane trailer	Gabriel	Upgrade
18163-01	83207	89407	HENS-20001	83389	89436	HENS-24088	83389	89436	HENS23566	85000	89436
18163-01	89407		HENS-20001	89436		HENS-24088	85000	89436	HENS23566	89436	
1816301	83207	89407	HENS-20002	85000	89436	HENS-24088	89436		HENS23649	85064	
1816301	89407		HENS-20002	89436		HENS20001	83389	89436	HENS24088	83389	89436
18164-01	83122	89406	HENS-20126	85323	89436	HENS20001	89436		HENS24088	85000	89436
18164-01	89406		HENS-20126	89436		HENS20002	85000	89436	HENS24088	89436	
1816401	83122	89406	HENS-21292	85052		HENS20002	89436		MER202447	85919	
1816401	89406		HENS-23566	85000	89436	HENS20126	85323	89436	REY18165-01	85006	
18165-01	85006		HENS-23566	89436		HENS20126	89436		REY1816501	85006	
1816501	85006		HENS-23649	85064		HENS21292	85052				

**Grech Motors**

Grech motors	Gabriel	Upgrade	Grech motors	Gabriel	Upgrade	Grech motors	Gabriel	Upgrade	Grech motors	Gabriel	Upgrade
ASH-1136	G63623		ASH-1154	G63622							

**Greyhound Bus**

Greyhound bus	Gabriel	Upgrade	Greyhound bus	Gabriel	Upgrade	Greyhound bus	Gabriel	Upgrade	Greyhound bus	Gabriel	Upgrade
12TA-01-013	85303	89422	12TA01013	85303	89422	3166657	85700		3192333	85700	
12TA-01-013	89422		12TA01013	89422		3178157	85700		690029	85700	

**Grupo A**

Grupo a	Gabriel	Upgrade	Grupo a	Gabriel	Upgrade	Grupo a	Gabriel	Upgrade	Grupo a	Gabriel	Upgrade
15055	14004		43026	81676		43121	81920		43381	61521	
15067	14004		43031	69724		43122	61600		43381	81394	
15500	6802SE		43040	61626		43122	81873		43387	81076	
15501	6804SE		43045	61501		43124	61500		43440	82130	
15502	6804SE		43045	81478		43124	81147		43455	61501	
15504	14071		43046	61500		43125	61520		43455	81478	
15504	6801SE		43046	81147		43125	81490		43511	81091	
164023	43140		43053	81446		43132	61554		43512	81091	
164028	43049		43054	81495		43132	81710		43725	82005	
39155	49155		43055	81494		43133	61554		43728	82001	
39205	49205		43057	G55825		43133	81710		43731	61614	
39218	49231		43059	61500		43134	G63909		43731	81821	
39569	49369		43059	81147		43139	83021		43734	82005	
43003	61524		43060	69464		43145	83021		43736	82001	
43003	81164		43066	83309		43154	69632		53002	81446	
43004	G63366		43069	81710		43156	G63907		53004	G63366	
43014	81340		43070	61520		43158	G63183		53008	G63929	
43019	81492		43070	81490		43171	82090				
43025	61519		43098	69945		43172	81469				
43025	81484		43119	61600		43236	61524				
43026	61550		43120	61641		43236	81164				

**Important Note:** Competitive Interchanges are to be used for stocking purposes only. Where multiple crosses are identified, please reference the applications section of this catalog. / **Remarque importante:** Les interchanges concurrentiels ne s'utilisent qu'aux fins de stocks. Dans le cas de références multiples, consulter la section des applications du catalogue. / **Nota importante:** Dans le cas de referencias multiples, consultar la sección de aplicaciones del catálogo. / **Nota importante:** Se pueden usar intercambios competitivos para propósitos de almacenamiento solamente. Cuando se identifican intercambios múltiples, consulte la sección de aplicaciones de este catálogo.

**COMPETITIVE & O.E.M. INTERCHANGE LIST**  
**Lista de Intercambios contra Competidores y Equipo Original.**  
**Liste d'interchange de produits compititifs & d'equipement original (OEM)**

**Grupo A... cont'd**

Grupo a	Gabriel	Upgrade	Grupo a	Gabriel	Upgrade	Grupo a	Gabriel	Upgrade	Grupo a	Gabriel	Upgrade
53009	G63624		53073	81930		58064	85070	89459	69091	G51799	
53010	83136		53081	83159		58069	61547		69092	69813	
53013	85071		53082	83515		58069	81082		69093	69450	
53016	G63773		53083	83159		58070	61520		69098	69946	
53017	G63772		53084	83515		58070	81490		69100	61593	
53018	83317		53091	83159		58178	61500		69100	81872	
53019	83456	89447	53195	G63183		58178	81147		69101	G55821	
53019	89447		53271	G63673		58337	58489		69104	G63889	
53020	61521		53272	G63662		58337	61544		69107	70003	
53020	81394		53273	G63674		58337	81668		69108	G64003	
53020	81744		53274	G63675		58341	61521		69109	70036	
53021	G63623		53275	G63661		58341	81394		69110	G51805	
53022	61504		53276	81873		58400	G63359		69114	70027	
53022	81750		53337	61544		58401	G63353		69115	70041	
53023	61528		53337	81668		69010	69898		69116	G51783	
53023	81482		53338	82003		69011	61600		69117	G63902	
53024	85005	89430	53341	61521		69012	61641		69119	G51738	
53025	61521		53341	81394		69013	61641		69123	69591	
53025	81394		53400	61523		69013	81920		69124	69589	
53026	85005	89430	53400	81096		69014	61600		69125	69590	
53028	G63489		53401	81091		69014	81873		69126	69587	
53029	61544		53402	G63360		69015	69464		69127	G51879	
53029	81668		58003	61524		69017	G63409		69129	G511004	
53032	81495		58003	81164		69018	G63414		69131	G51874	
53035	G63488		58004	G63366		69023	69473		69132	G51983	
53036	81091		58012	85314	89425	69024	61500		69133	G51990	
53037	61565		58012	89425		69024	81478		69134	G51721	
53039	85006		58034	85013	89414	69025	61501		69135	69592	
53040	85006		58034	89414		69025	81147		69136	70095	
53041	85310	89423	58035	58488		69031	61528		69137	G51898	
53041	89423		58035	61543		69034	69909		69146	G51971	
53042	83309		58035	81667		69036	69900		69147	G51848	
53043	83215		58038	85001	89410	69038	G51700		69150	G64056	
53044	83124	89407	58038	89410		69040	61506		69151	G63872	
53051	61520		58040	85026		69040	81318		69152	70052	
53051	81490		58041	83456	89447	69041	61662		69153	G511030	
53052	61530		58041	89447		69042	61662		69155	G51863	
53052	81510		58048	83137		69043	61506		69159	G63907	
53053	G63386		58049	85000	89436	69043	81318		69160	G64050	
53057	G63359		58049	85323	89436	69044	69465		69164	G511007	
53058	G63353		58049	89436		69045	G51736		69170	G64050	
53059	85051		58050	85061	89450	69046	G63845		69171	G51807	
53060	81935		58050	89450		69048	G63909		69172	G511044	
53061	G63413		58054	61530		69048	G64001		69175	69464	
53063	83025		58054	81510		69049	G63965		69177	G51905	
53065	83136		58055	85003	89411	69077	G63813		69179	G51892	
53066	83124	89407	58055	89411		69078	G63492		69180	G511002	
53066	89407		58056	83137		69080	61506		69226	69945	
53068	G51850		58057	83456	89447	69080	81318		69247	70098	
53069	81710		58057	89447		69081	G63712		69248	70003	
53070	61520		58058	85031		69084	G51815		69253	G511078	
53070	81490		58059	85005	89430	69085	G63890		69300	G63349	
53070	81913		58059	89430		69086	G63890		69309	58929	
53071	61519		58061	83122	89406	69088	69595		69309	61520	
53071	81484		58061	85916	89430	69089	69594		69309	61561	
53072	81925		58061	89406		69090	G64031		69309	81490	

**Important Note:** Competitive Interchanges are to be used for stocking purposes only. Where multiple crosses are identified, please reference the applications section of this catalog./ **Remarque importante:** Les interchanges concurrentiels ne s'utilisent qu'aux fins de stocks. Dans le cas de rfrences multiples, consulter la section des applications du catalogue./ **Nota importante:** Dans le cas de rfrences multiples, consulter la section des applications du catalogue./ **Nota importante:** Se pueden usar intercambios competitivos para propósitos de almacenamiento solamente. Cuando se identifican intercambios múltiples, consulte la sección de aplicaciones de este catálogo.

**COMPETITIVE & O.E.M. INTERCHANGE LIST**  
**Lista de Intercambios contra Competidores y Equipo Original.**  
**Liste dinterchange de produits comptitifs & dquipement original (OEM)**

**Grupo A... cont'd**

Grupo a	Gabriel	Upgrade	Grupo a	Gabriel	Upgrade	Grupo a	Gabriel	Upgrade	Grupo a	Gabriel	Upgrade
69309	81744		69520	61544		69658	61504		69748	89410	
69310	61533		69521	61543		69660	G51728		69750	85314	89425
69310	81490		69522	G63638		69661	G63844		69750	89425	
69310	81744		69523	61544		69663	61555		69752	85316	89426
69312	81492		69532	G63884		69664	61565		69752	89426	
69321	61500		69534	G51815		69666	61655		69753	85031	
69321	81147		69535	G63891		69668	G63918		69760	85924	89457
69322	81446		69536	G51815		69669	83123	89405	69762	85931	89458
69323	69606		69537	G63844		69669	85010		69963	G55681	
69323	81495		69538	61683		69669	89405		72001	G63870	
69326	61500		69539	61684		69670	85051		72004	G64026	
69326	81147		69541	G63867		69671	85006		72005	G51798	
69330	81710		69544	G63622		69672	85043		72006	G64003	
69334	82156		69545	61595		69673	83209	89414	72007	G64063	
69338	69632		69546	61591		69673	89414		72008	G64052	
69346	81091		69547	61533		69678	G63674		72009	G64089	
69347	G63355		69548	61520		69679	G63675		72020	G64043	
69355	61523		69548	61561		69680	89402		72022	G63959	
69355	81096		69548	81490		69685	83136		72026	G63902	
69355	81834		69548	81744		69688	85302	89420	72027	G51766	
69357	81091		69549	58929		69688	89420		72028	G64063	
69361	61614		69549	61591		69692	61663		72029	G64031	
69369	81147		69550	61518		69693	61675		72030	G63959	
69370	81478		69550	61595		69696	G63862		72033	G63614	
69376	81478		69550	81242		69697	G63676		72037	G64157	
69379	69632		69554	61554		69699	G63907		72038	G64040	
69381	61500		69555	G63714		69705	83122	89406	72039	G63886	
69381	81147		69556	G63778		69705	89406		72040	G64104	
69382	81342		69557	G63662		69711	83207	89407	72049	G64037	
69383	61632		69563	61634		69711	89407		78001	85314	89425
69383	81825		69582	G63848		69712	85013	89414	78001	89425	
69389	69845		69583	61692		69712	89414		78002	85702	
69391	81916		69584	G64012		69713	85046	89434	78003	85308	89422
69392	81917		69585	61720		69713	89434		78003	89422	
69395	61520		69587	61710		69716	85024		78005	85310	89423
69395	81490		69588	G63971		69717	85310	89423	78005	89423	
69396	61547		69590	61615		69717	89423		78007	85307	
69396	81082		69591	61616		69720	85736		78008	85314	89425
69500	83122	89406	69592	61714		69726	85319	89428	78009	85303	89422
69500	89406		69593	61654		69726	89428		78009	89422	
69501	61543		69594	61713		69728	85055	89439	78013	85323	89436
69502	G63424		69601	61554		69728	89439		78013	89436	
69503	61544		69605	G64015		69729	85314	89425	78015	85724	89443
69504	G63425		69610	G63915		69729	89425		78015	89443	
69505	61506		69611	G63403		69732	85300	89419	78016	85001	89410
69506	61523		69612	61535		69732	89419		78016	89410	
69507	G63353		69613	G63683		69741	85906	89407	78020	85712	
69509	61554		69615	G63678		69741	89407		78023	85705	89447
69510	61520		69616	G63607		69743	85061	89450	78023	89447	
69511	G63299		69622	61642		69743	89450		78025	85009	
69513	61626		69623	61635		69745	85058	89431	78027	85314	89425
69515	83124	89407	69651	G63488		69745	89431		78027	89425	
69515	89407		69653	58488		69746	83137		78030	85316	89426
69516	G63423		69654	61659		69747	85003	89411	78030	89426	
69517	61528		69656	61512		69747	89411		78034	85920	89503
69519	61599		69657	61658		69748	85001	89410	78039	85311	89424

**Important Note:** Competitive Interchanges are to be used for stocking purposes only. Where multiple crosses are identified, please reference the applications section of this catalog. / **Remarque importante:** Les interchanges concurrentiels ne s'utilisent qu'aux fins de stocks. Dans le cas de références multiples, consulter la section des applications du catalogue. / **Nota importante:** Dans le cas de références multiples, consulter la section des applications du catalogue. / **Nota importante:** Se pueden usar intercambios competitivos para propósitos de almacenamiento solamente. Cuando se identifican intercambios múltiples, consulte la sección de aplicaciones de este catálogo.

**COMPETITIVE & O.E.M. INTERCHANGE LIST**  
**Lista de Intercambios contra Competidores y Equipo Original.**  
**Liste dinterchange de produits comptitifs & dquipement original (OEM)**

**Grupo A... cont'd**

Grupo a	Gabriel	Upgrade	Grupo a	Gabriel	Upgrade	Grupo a	Gabriel	Upgrade	Grupo a	Gabriel	Upgrade
78039	89424		79211	G56774		79326L	G52173		USA69117	81478	
79053	G56606		79217	G52300		79326R	G52174		USA69131	G51874	
79059	G51268		79218	G52299		79327L	G52173		USA69133	G51990	
79060	G51267		79219	G52082		79327R	G52174		USA69135	69592	
79061	G56517		79220	G52081		79329L	G52410		USA69137	G51898	
79062	G56516		79221	G51842		79329R	G52411		USA69150	G64056	
79064	G55948		79222	G52122		79333L	G52127		USA69391	G63772	
79065	G55949		79227	G52104		79333R	G52128		USA69392	G63773	
79070	G55892		79228	G52103		79334L	G52127		USA69517	61528	
79077	G55896		79229	G51723		79334R	G52128		USA69522	61544	
79078	G55949		79230	G51724		79335L	G52360		USA69532	G63884	
79092	G56568		79231	G56838		79335R	G52361		USA69538	61683	
79093	G56601		79232	G56839		79337L	G52203		USA69539	61684	
79096	G56799		79233	G56807		79337R	G52204		USA69544	G63622	
79097	G56800		79234	G56817		79339	G51896		USA69555	61611	
79098	G56660		79245	G52006		79339	G51897		USA69556	G63717	
79099	G56661		79246	G52005		79341L	G52148		USA69582	G63848	
79103	G56778		79249	G51761		79341R	G52149		USA69583	61692	
79117	G56620		79250	G51760		79343	G511000		USA69584	G64012	
79128	G56672		79253	G52354		79347L	G52351		USA69585	61720	
79129	G56671		79254	G52353		79347R	G52352		USA69586	G63892	
79132	G56778		79259L	G52245		81740	61560		USA69587	61710	
79141	G51739		79259R	G52246		81740	81904		USA69588	G63971	
79143	G56899		79264	G51908		85037	G55698		USA69589	G63958	
79148	G51097		79271	G51870		85039	G56517		USA69592	61714	
79153	G52005		79276L	G52148		G63626	G63683		USA69594	61713	
79154	G52006		79276R	G52149		G63626	G63829		USA69601	61554	
79162	G52155		79277L	G52210		G69795	69795		USA69606	61605	
79163	G52154		79277R	G52209		TX69115	70041		USA69606	81878	
79164	G56797		79278L	G52127		TX79195	G56886		USA69612	61535	
79165	G56798		79278R	G52128		TX79196	G56887		USA69612	61664	
79166	G56582		79284L	G52494		USA53094	83137		USA69613	61575	
79167	G56581		79284R	G52495		USA53101	83038		USA69613	61676	
79168	G51703		79286L	G52117		USA53102	83906		USA69615	61623	
79173	G52008		79286R	G52118		USA58017	83164		USA69616	61624	
79174	G52009		79291L	G52173		USA58072	85936	89456	USA69658	61504	
79175	G52095		79291R	G52174		USA58073	85084	89460	USA69660	G63844	
79176	G52094		79292	G52131		USA58077	85337		USA69661	G51728	
79179	G51704		79294L	G52152		USA58080	85932	89453	USA69664	61565	
79184	G52188		79294R	G52153		USA58081	85920	89503	USA69666	61655	
79185	G52187		79299L	G52255		USA58082	85932	89453	USA69668	G63918	
79186	G52007		79299R	G52256		USA69011	G63662		USA69689	83127	
79187	G52004		79309	G51972		USA69011	G63866		USA69692	61663	
79188	G56843		79310L	G52148		USA69012	G63783		USA69693	61675	
79189	G56842		79310R	G52149		USA69012	G63803		USA69696	G63862	
79190	G56758		79311L	G52187		USA69013	61641		USA69696	G64047	
79191	G56759		79311R	G52188		USA69013	81920		USA69697	G63676	
79195	G56886		79315L	G51877		USA69014	61600		USA69699	61500	
79196	G56887		79315R	G51878		USA69014	81873		USA69718	85321	
79201	G52185		79317	G51865		USA69031	61528		USA69749	85013	89414
79202	G52184		79319	G64148		USA69034	69909		USA69756	85957	
79203	G51859		79320	G52125		USA69080	61506		USA69758	85061	89450
79204	G51859		79322	G51719		USA69080	81318		USA69759	83148	
79207	G56810		79324L	G52260		USA69092	69813		USA72001	G63870	
79208	G56810		79324R	G52261		USA69115	70041		USA72002	61535	
79210	G56773		79325	G51740		USA69117	61501		USA72003	61575	

**Important Note:** Competitive Interchanges are to be used for stocking purposes only. Where multiple crosses are identified, please reference the applications section of this catalog. / **Remarque importante:** Les interchanges concurrentiels ne s'utilisent qu'aux fins de stocks. Dans le cas de références multiples, consulter la section des applications du catalogue. / **Nota importante:** Dans le cas de références multiples, consulter la section des applications du catalogue. / **Nota importante:** Se pueden usar intercambios competitivos para propósitos de almacenamiento solamente. Cuando se identifican intercambios múltiples, consulte la sección de aplicaciones de este catálogo.

# COMPETITIVE & O.E.M. INTERCHANGE LIST

## Lista de Intercambios contra Competidores y Equipo Original.

### Liste d'interchange de produits compétitifs & d'équipement original (OEM)

#### Grupo A... cont'd

Grupo a	Gabriel	Upgrade	Grupo a	Gabriel	Upgrade	Grupo a	Gabriel	Upgrade	Grupo a	Gabriel	Upgrade
USA72004	G64026		USA78066	85727		USA79196	G56887		USA79234	G56817	
USA72004	G64151		USA79053	G56606		USA79217	G52300		USA79259L	G52245	
USA72006	G64003		USA79092	G56568		USA79218	G52299		USA79259R	G52246	
USA72014	83128	89436	USA79093	G56601		USA79219	G52082		USA79262	G56894	
USA72015	85052		USA79103	G56778		USA79220	G52081		USA79263	G56894	
USA72016	83128	89436	USA79117	G56620		USA79221	G51842		USA79264	G51908	
USA72020	G51856		USA79132	G56778		USA79222	G52122		USA79271	G51949	
USA72023	83908		USA79166	G56581		USA79223	G52121		USA79277L	G52209	
USA72035	G64042		USA79167	G56582		USA79227	G52104		USA79277R	G52210	
USA78000	85302	89420	USA79168	G51703		USA79228	G52103		USA79284L	G52494	
USA78031	85311	89424	USA79179	G51704		USA79229	G51723		USA79284R	G52495	
USA78040	85314	89425	USA79184	G52188		USA79230	G51724		USA79343	G511000	
USA78051	85918	89449	USA79186	G52007		USA79231	G56838				
USA78054	85736		USA79187	G52004		USA79232	G56839				
USA78064	85301		USA79195	G56886		USA79233	G56807				

#### Grumman Bus

Grumman bus	Gabriel	Upgrade	Grumman bus	Gabriel	Upgrade	Grumman bus	Gabriel	Upgrade	Grumman bus	Gabriel	Upgrade
22025067	85704		97-2210-00002	85704		97221000001	85704		97221000005	85704	
22025305	85704		97-2210-00003	85704		97221000002	85704				
690029	85700		97-2210-00004	85704		97221000003	85704				
97-2210-00001	85704		97-2210-00005	85704		97221000004	85704				

#### Gulf Stream Coach

Gulf stream coach	Gabriel	Upgrade	Gulf stream coach	Gabriel	Upgrade	Gulf stream coach	Gabriel	Upgrade	Gulf stream coach	Gabriel	Upgrade
141700131809	85029		16-18103-000	85900		88982682	83136		ASH-1136	G63623	
141700131810	83160		1616736000	85029		8C24-18045-DA	G63622		ASH-1154	G63622	
15123676	83136		1616737000	83160		8C24-18080-DB	G63623		ASH1136	G63623	
15588554	83136		1616873000	85029		8C2418045DA	G63622		ASH1154	G63622	
15887728	83136		1616874000	83160		8C2418080DB	G63623		AT-163G	G63622	
16-16736-000	85029		1618103000	85900		8C2Z-18124-D	G63622		AT-164G	G63623	
16-16737-000	83160		19152843	83136		8C2Z-18125-D	G63623		AT163G	G63622	
16-16873-000	85029		22064230	83136		8C2Z18124D	G63622		AT164G	G63623	
16-16874-000	83160		481700000493	85900		8C2Z18125D	G63623				

#### Hardee Mfg.

Hardee mfg.	Gabriel	Upgrade	Hardee mfg.	Gabriel	Upgrade	Hardee mfg.	Gabriel	Upgrade	Hardee mfg.	Gabriel	Upgrade
8030223	83207	89407	8030223	89407		AS789B	85014				

#### Hausman

Hausman	Gabriel	Upgrade	Hausman	Gabriel	Upgrade	Hausman	Gabriel	Upgrade	Hausman	Gabriel	Upgrade
695110	85318		695119	85702							

#### Hendrickson

Hendrickson	Gabriel	Upgrade	Hendrickson	Gabriel	Upgrade	Hendrickson	Gabriel	Upgrade	Hendrickson	Gabriel	Upgrade
471700000460	85959		680463	89440		HD58913011	85959		HTSS25436	85916	89430
471700006270	85932	89453	680570	89437		HTSS20002	85000	89436	S-23362	89437	
471700006270	89453		680616	89430		HTSS23566	85000	89436	S2212HDR	85029	
60657-017	85979		98583-020	89414		HTSS24023	85738				
671779	89414		B-23362	89437		HTSS24088	83389	89436			

#### Hendrickson Trailer Suspension Systems

Hendrickson trailer suspension systems	Gabriel	Upgrade	Hendrickson trailer suspension systems	Gabriel	Upgrade	Hendrickson trailer suspension systems	Gabriel	Upgrade	Hendrickson trailer suspension systems	Gabriel	Upgrade
060665-014	85962		47902-11	89407		47902-20	89405		47902-28	85013	89414
060665-018	85961		47902-13	83122	89406	47902-21	85976		47902-28	89414	
060665014	85962		47902-13	89406		47902-22	85916	89430	47902-29	83149	
12738	83225		47902-15	83137		47902-22	89430		47902-3	85005	89430
471700000456	85959		47902-18	85030	89440	47902-24	83137		47902-3	89430	
471700006269	85932	89453	47902-18	89440		47902-25	83125		47902-8	83122	89406
471700006269	89453		47902-19	83123	89405	47902-26	83144		47902-8	89406	
471700131545	85006		47902-19	89405		47902-27	83123	89405	47902-9	83123	89405
47902-11	83207	89407	47902-20	85036	89405	47902-27	89405		47902-9	89405	

**Important Note:** Competitive Interchanges are to be used for stocking purposes only. Where multiple crosses are identified, please reference the applications section of this catalog. / **Remarque importante:** Les interchanges concurrentiels ne s'utilisent qu'aux fins de stocks. Dans le cas de références multiples, consulter la section des applications du catalogue. / **Nota importante:** Dans le cas de referencias multiples, consultar la sección de aplicaciones del catálogo. / **Nota importante:** Se pueden usar intercambios competitivos para propósitos de almacenamiento solamente. Cuando se identifican intercambios múltiples, consulte la sección de aplicaciones de este catálogo.



**COMPETITIVE & O.E.M. INTERCHANGE LIST**  
**Lista de Intercambios contra Competidores y Equipo Original.**  
**Liste dinterchange de produits comptitifs & dquipement original (OEM)**

**Hendrickson Trailer Suspension Systems... cont'd**

Hendrickson trailer suspension systems	Gabriel	Upgrade	Hendrickson trailer suspension systems	Gabriel	Upgrade	Hendrickson trailer suspension systems	Gabriel	Upgrade	Hendrickson trailer suspension systems	Gabriel	Upgrade
4790211	83207	89407	573243	89430		598511	85976		60665020	85919	
4790211	89407		573246	85043		59852-1	85977		60665025	85036	89405
4790213	83122	89406	57905-1	85976		59852-2	85977		60665025	89405	
4790213	89406		57905-2	85006		598521	85977		60665025L	85036	89405
4790215	83137		579051	85976		598522	85977		60665025L	89405	
4790218	85030	89440	579052	85006		60657-003	85072		60670-001	83123	89405
4790218	89440		58623-1	85978		60657-003L	85072		60670-001	89405	
4790219	83123	89405	586231	85978		60657-004	85072		60670-002	83207	89407
4790219	89405		58913-003	85932	89453	60657-005	85087		60670-002	89407	
4790220	85036	89405	58913-003	89453		60657-005L	85087		60670-002L	83207	89407
4790220	89405		58913-003L	85932	89453	60657-006	85102		60670-003L	89407	
4790221	85976		58913-003L	89453		60657-007	85072		60670-003	83149	
4790222	85916	89430	58913-007	85959		60657-010	85102		60670-004	83123	89405
4790222	89430		58913-007L	85959		60657-011	85102		60670-004	89405	
4790224	83137		58913-008	85959		60657003	85072		60670-005	83137	
4790225	83125		58913-008L	85959		60657003L	85072		60670-006	83147	
4790226	83144		58913-009	85959		60657004	85072		60670-006L	83147	
4790227	83123	89405	58913-009L	85959		60657005	85087		60670-007	83144	
4790227	89405		58913-011	85959		60657005L	85087		60670-007L	83144	
4790228	85013	89414	58913-011L	85959		60657006	85102		60670-008	83123	89405
4790228	89414		58913-012	85932	89453	60657007	85072		60670-008	89405	
4790229	83149		58913-012	89453		60657010	85102		60670-008L	83123	89405
479023	85005	89430	58913-012L	85932	89453	60657011	85102		60670-008L	89405	
479023	89430		58913-012L	89453		60665-003	83137		60670-009	85013	89414
479028	83122	89406	58913-015	85200		60665-004	85036	89405	60670-009	89414	
479028	89406		58913-015L	85200		60665-004	89405		60670-010	83149	
479029	83123	89405	58913003	85932	89453	60665-004L	85036	89405	60670-011	83148	
479029	89405		58913003	89453		60665-004L	89405		60670-012	83168	
503610C2	83207	89407	58913003L	85932	89453	60665-005	85919		60670-013	83148	
503610C2	89407		58913003L	89453		60665-005L	85919		60670-014	83166	
5554596	85303	89422	58913007	85959		60665-008	85978		60670-017	83148	
5554596	89422		58913007L	85959		60665-009	85043		60670-018	83166	
57241-001	83111		58913008	85959		60665-011	85967		60670-019	83166	
57241-002	83109		58913008L	85959		60665-013	85965		60670-020	83148	
57241-003	83112		58913009	85959		60665-014	85962		60670-12	83168	
57241-004	83110		58913009L	85959		60665-018	85961		60670001	83123	89405
57241-006	83111		58913011	85959		60665-018L	85961		60670001	89405	
57241-006L	83111		58913011L	85959		60665-020	85919		60670002	83207	89407
57241001	83111		58913012	85932	89453	60665-025	85036	89405	60670002	89407	
57241002	83109		58913012	89453		60665-025	89405		60670002L	83207	89407
57241003	83112		58913012L	85932	89453	60665-025L	85036	89405	60670002L	89407	
57241004	83110		58913012L	89453		60665-025L	89405		60670003	83149	
57241006	83111		58913015	85200		60665003	83137		60670004	83123	89405
57241006L	83111		59048-001	83148		60665004	85036	89405	60670004	89405	
57324-1	85036	89405	59048001	83148		60665004	89405		60670005	83137	
57324-1	89405		59057-001	83137		60665004L	85036	89405	60670006	83147	
57324-11	85305		59057-002	85036	89405	60665004L	89405		60670006L	83147	
57324-2	85976		59057-002	89405		60665005	85919		60670007	83144	
57324-3	85916	89430	59057001	83137		60665005L	85919		60670007L	83144	
57324-3	89430		59057002	85036	89405	60665008	85978		60670008	83123	89405
57324-6	85043		59057002	89405		60665009	85043		60670008	89405	
573241	85036	89405	59305-1	85979		60665011	85967		60670008L	83123	89405
573241	89405		593051	85979		60665013	85965		60670008L	89405	
5732411	85305		59483-000	85919		60665014	85962		60670009	85013	89414
573242	85976		59483000	85919		60665018	85961		60670009	89414	
573243	85916	89430	59851-1	85976		60665018L	85961		60670010	83149	

**Important Note:** Competitive Interchanges are to be used for stocking purposes only. Where multiple crosses are identified, please reference the applications section of this catalog. / **Remarque importante:** Les interchanges concurrentiels ne s'utilisent qu'aux fins de stocks. Dans le cas de rferences multiples, consulter la section des applications du catalogue. / **Nota importante:** En el caso de rferencias mltiples, consultar la seccion de aplicaciones del catalogo. / **Nota importante:** Se pueden usar intercambios competitivos para propósitos de almacenamiento solamente. Cuando se identifican intercambios mltiples, consulte la seccion de aplicaciones de este catalogo.

**COMPETITIVE & O.E.M. INTERCHANGE LIST**  
**Lista de Intercambios contra Competidores y Equipo Original.**  
**Liste dinterchange de produits comptitifs & dquipement original (OEM)**

**Hendrickson Trailer Suspension Systems... cont'd**

Hendrickson trailer suspension systems	Gabriel	Upgrade	Hendrickson trailer suspension systems	Gabriel	Upgrade	Hendrickson trailer suspension systems	Gabriel	Upgrade	Hendrickson trailer suspension systems	Gabriel	Upgrade
60670011	83148		60680-005L	83142		654900	83149		671006	89405	
60670012	83168		60680001	83111		654903	83111		671007	83137	
60670013	83148		60680001L	83111		654904	83109		671009	85919	
60670014	83166		60680002	83109		654905	83112		671105	85072	
60670017	83148		60680003	83112		654951	85000	89436	671603	85919	
60670018	83166		60680003L	83112		654951	89436		671606	85955	
60670019	83166		60680004	83143		659000	83148		671611	85955	
60670020	83148		60680004L	83143		659004	83123	89405	671704	85043	
6067012	83168		60680005	83142		659004	89405		671764	85967	
60675-001	85978		60680005L	83142		659024	85052		671792	85965	
60675-001L	85978		60685-001	85977		659048	83143		671798	85962	
60675-002	85979		60685001	85977		659049	83142		671948	85000	89436
60675-002L	85979		60998-001	85006		659155	83147		671948	89436	
60675-003	85976		60998-002	85919		659202	83148		680091	85303	89422
60675-003L	85976		60998-002L	85919		659292	83148		680091	89422	
60675-004	85006		60998-003	85006		65992-001	85955		680102	85712	
60675-006	85909		60998001	85006		65992-002	85955		680341	85323	89436
60675-006L	85909		60998002	85919		65992-002L	85955		680341	89436	
60675-007	83122	89406	60998002L	85919		65992-003	85959		680467	85323	89436
60675-007	89406		60998003	85006		65992001	85955		680467	89436	
60675-009	85978		64838-001	85933	89454	65992002	85955		680509	85738	
60675-010	85036	89405	64838-001	89454		65992002L	85955		680565	85738	
60675-010	89405		64838-001L	85933	89454	65992003	85959		680566	85938	
60675-013	83123	89405	64838-001L	89454		665190	85006		680568	85323	89436
60675-013	89405		64838-002	85933	89454	665246	85043		680568	89436	
60675-014	85978		64838-002	89454		665267	85029		680571	85738	
60675-017	85979		64838-002L	85933	89454	665405	85030	89440	680573	85939	
60675-12	85638		64838-002L	89454		665405	89440		680579	85939	
60675001	85978		64838-003	85933	89454	665406	85010		680600	85305	
60675001L	85978		64838-003	89454		665531	85000	89436	680614	85338	
60675002	85979		64838-003L	85933	89454	665531	89436		680617	85337	
60675002L	85979		64838-003L	89454		665532	85013	89414	680702	85323	89436
60675003	85976		64838001	85933	89454	665532	89414		680702	89436	
60675003L	85976		64838001	89454		665533	85005	89430	680756	85323	89436
60675004	85006		64838001L	85933	89454	665533	89430		680756	89436	
60675006	85909		64838001L	89454		665536	85000	89436	680769	85911	
60675006L	85909		64838002	85933	89454	665536	89436		680776	85338	
60675007	83122	89406	64838002	89454		665693	85064		70018	85303	89422
60675007	89406		64838002L	85933	89454	665694	85052		70018	89422	
60675009	85978		64838002L	89454		665698	85911		70021	85303	89422
60675010	85036	89405	64838003	85933	89454	665733	85045		70021	89422	
60675010	89405		64838003	89454		665756	85000	89436	70088	85307	
60675013	83123	89405	64838003L	85933	89454	665756	89436		98583-005	83168	
60675013	89405		64838003L	89454		665758	85064		98583-006	83148	
60675014	85978		654890	83207	89407	665759	85052		98583-016	83147	
60675017	85979		654890	89407		665760	85045		98583-019	85323	89436
6067512	85638		654891	83149		665761	85911		98583-019	89436	
606758Q	85976		654894	83123	89405	665763	85079		98583-032	85072	
60680-001	83111		654894	89405		665764	85029		98583005	83168	
60680-001L	83111		654895	83137		665765	83150		98583006	83148	
60680-002	83109		654896	83147		665766	85000	89436	98583016	83147	
60680-003	83112		654897	83144		665766	89436		98583019	85323	89436
60680-003L	83112		654898	83123	89405	665767	85045		98583019	89436	
60680-004	83143		654898	89405		665816	85072		98583032	85072	
60680-004L	83143		654899	85013	89414	665892	85072		A-10023	85000	89436
60680-005	83142		654899	89414		671006	85036	89405	A-10023	89436	

**Important Note:** Competitive Interchanges are to be used for stocking purposes only. Where multiple crosses are identified, please reference the applications section of this catalog. / **Remarque importante:** Les interchanges concurrentiels ne s'utilisent qu'aux fins de stocks. Dans le cas de rferences multiples, consulter la section des applications du catalogue. / **Nota importante:** Dans le cas de rferences multiples, consulter la section des applications du catalogue. / **Nota importante:** Se pueden usar intercambios competitivos para propósitos de almacenamiento solamente. Cuando se identifican intercambios múltiples, consulte la sección de aplicaciones de este catálogo.

**COMPETITIVE & O.E.M. INTERCHANGE LIST**  
**Lista de Intercambios contra Competidores y Equipo Original.**  
**Liste dinterchange de produits comptitifs & dquipement original (OEM)**

**Hendrickson Trailer Suspension Systems... cont'd**

Hendrickson trailer suspension systems	Gabriel	Upgrade	Hendrickson trailer suspension systems	Gabriel	Upgrade	Hendrickson trailer suspension systems	Gabriel	Upgrade	Hendrickson trailer suspension systems	Gabriel	Upgrade
A-10348	85043		A20002	85000	89436	B-23548	85079		B23649	85064	
A-11931	85000	89436	A20002	89436		B-23566	85000	89436	B23650	85052	
A-11931	89436		A20126	85323	89436	B-23566	89436		B23651	85045	
A-14496	646155		A20126	89436		B-23649	85064		B23743	85938	
A-14583	85000	89436	A20345	85345		B-23650	85052		B24023	85738	
A-14583	89436		A20886	85030	89440	B-23651	85045		B24088	83389	89436
A-1667	85000	89436	A20886	89440		B-23743	85938		B24088	85000	89436
A-1667	89436		A20887	85005	89430	B-24023	85738		B24088	89436	
A-1668	85000	89436	A20887	89430		B-24088	83389	89436	B24125	85323	89436
A-1668	89436		A20889	85323	89436	B-24088	85000	89436	B24125	89436	
A-20001	83389	89436	A20889	89436		B-24088	89436		B24579	85939	
A-20001	89436		A21292	85052		B-24125	85323	89436	B25174	85029	
A-20002	85000	89436	A2160	85014		B-24125	89436		B25436	85916	89430
A-20002	89436		A2212	85029		B-24579	85939		B25436	89430	
A-20126	85323	89436	A2213	85010		B-25174	85029		B25437	85337	
A-20126	89436		A2218	85030	89440	B-25436	85916	89430	B25515	85338	
A-20345	85345		A2218	89440		B-25436	89430		B26652	85000	89436
A-20886	85030	89440	A2230	85005	89430	B-25437	85337		B26652	89436	
A-20886	89440		A2230	89430		B-25515	85338		B27058	83128	89436
A-20887	85005	89430	A2232	85005	89430	B-26652	85000	89436	B27058	89436	
A-20887	89430		A2232	89430		B-26652	89436		B27747	85911	
A-20889	85323	89436	A2240	85013	89414	B-27058	83128	89436	B29432	85323	89436
A-20889	89436		A2240	89414		B-27058	89436		B29432	89436	
A-21292	85052		A22401	85043		B-27747	85911		B29678	85911	
A-2160	85014		A2471	85006		B-29432	85323	89436	B29826	85338	
A-2212	85029		A4084	85005	89430	B-29432	89436		B33312	85338	
A-2213	85010		A4084	89430		B-29678	85911		B33313	85338	
A-2218	85030	89440	A4089	83209	89414	B-29826	85338		BE76164-2	85303	89422
A-2218	89440		A4089	89414		B-33312	85338		BE76164-2	89422	
A-2230	85005	89430	A4890	85712		B-33313	85338		BE76164-3	85307	
A-2230	89430		A6156	85301		B-33314	85939		BE76164-4	83225	
A-2232	85005	89430	AE76164-3	85307		B-33314L	85939		BE761642	85303	89422
A-2232	89430		AE76164-4	83225		B20345	85345		BE761642	89422	
A-2240	85013	89414	AE761643	85307		B21553	85738		BE761643	85307	
A-2240	89414		AE761644	83225		B21699	87018		BE761644	83225	
A-2240-1	85043		B-20345	85345		B21832	85323	89436	HDR 58913 015	85200	
A-2471	85006		B-21553	85738		B21832	89436		NS500699	85005	89430
A-4084	85005	89430	B-21699	87018		B21936	85064		NS500699	89430	
A-4084	89430		B-21832	85323	89436	B21947	85052		S-10348	85043	
A-4089	83209	89414	B-21832	89436		B21994	85938		S-14583	85000	89436
A-4089	89414		B-21936	85064		B22311	85045		S-14583	89436	
A-4890	85712		B-21947	85052		B22312	85939		S-1667	85000	89436
A-6156	85301		B-21994	85938		B22345	85911		S-1667	89436	
A10023	85000	89436	B-22311	85045		B22715	85000	89436	S-1668	85000	89436
A10023	89436		B-22312	85939		B22715	89436		S-1668	89436	
A10348	85043		B-22345	85911		B22862	85045		S-20001	83389	89436
A11931	85000	89436	B-22715	85000	89436	B23013	85000	89436	S-20001	89436	
A11931	89436		B-22715	89436		B23013	89436		S-20002	85000	89436
A14583	85000	89436	B-22862	85045		B23014	85738		S-20002	89436	
A14583	89436		B-23013	85000	89436	B23290	83150		S-20126	85323	89436
A1667	85000	89436	B-23013	89436		B23315	85029		S-20126	89436	
A1667	89436		B-23014	85738		B23316	85382		S-20345	85345	
A1668	85000	89436	B-23290	83150		B23361	85911		S-20886	85030	89440
A1668	89436		B-23315	85029		B23548	85079		S-20886	89440	
A20001	83389	89436	B-23316	85382		B23566	85000	89436	S-20887	85005	89430
A20001	89436		B-23361	85911		B23566	89436		S-20887	89430	

**Important Note:** Competitive Interchanges are to be used for stocking purposes only. Where multiple crosses are identified, please reference the applications section of this catalog. / **Remarque importante:** Les interchanges concurrentiels ne s'utilisent qu'aux fins de stocks. Dans le cas de rferences multiples, consulter la section des applications du catalogue. / **Nota importante:** Dans le cas de rferences multiples, consulter la section des applications du catalogue. / **Nota importante:** Se pueden usar intercambios competitivos para propósitos de almacenamiento solamente. Cuando se identifican intercambios múltiples, consulte la sección de aplicaciones de este catálogo.

**COMPETITIVE & O.E.M. INTERCHANGE LIST**  
**Lista de Intercambios contra Competidores y Equipo Original.**  
**Liste dinterchange de produits comptitifs & dquipement original (OEM)**

**Hendrickson Trailer Suspension Systems... cont'd**

Hendrickson trailer suspension systems	Gabriel	Upgrade	Hendrickson trailer suspension systems	Gabriel	Upgrade	Hendrickson trailer suspension systems	Gabriel	Upgrade	Hendrickson trailer suspension systems	Gabriel	Upgrade
S-20889	85323	89436	S-23651	85045		S20002	89436		S23315	85029	
S-20889	89436		S-23743	85938		S20126	85323	89436	S23316	85382	
S-21292	85052		S-24023	85738		S20126	89436		S23361	85911	
S-21553	85738		S-24088	83389	89436	S20345	85345		S23548	85079	
S-2160	85014		S-24088	85000	89436	S20886	85030	89440	S23566	85000	89436
S-21699	87018		S-24088	89436		S20886	89440		S23566	89436	
S-21832	85323	89436	S-24125	85323	89436	S20887	85005	89430	S23649	85064	
S-21832	89436		S-24125	89436		S20887	89430		S23650	85052	
S-21936	85064		S-24579	85939		S20889	85323	89436	S23651	85045	
S-21947	85052		S-2471	85006		S20889	89436		S23743	85938	
S-2212	85029		S-25436	85916	89430	S21292	85052		S24023	85738	
S-2213	85010		S-25436	89430		S21553	85738		S24088	83389	89436
S-2218	85030	89440	S-25437	85337		S2160	85014		S24088	85000	89436
S-2218	89440		S-25515	85338		S21699	87018		S24088	89436	
S-2230	85005	89430	S-26652	85000	89436	S21832	85323	89436	S24125	85323	89436
S-2230	89430		S-26652	89436		S21832	89436		S24125	89436	
S-22311	85045		S-29432	85323	89436	S21936	85064		S24579	85939	
S-22312	85939		S-29432	89436		S21947	85052		S2471	85006	
S-2232	85005	89430	S-29678	85911		S2212	85029		S25436	85916	89430
S-2232	89430		S-29826	85338		S2213	85010		S25436	89430	
S-22345	85911		S-33312	85338		S2218	85030	89440	S25437	85337	
S-2240	85013	89414	S-33313	85338		S2218	89440		S25515	85338	
S-2240	89414		S-33313L	85338		S2230	85005	89430	S26652	85000	89436
S-22715	85000	89436	S-4084	85005	89430	S2230	89430		S26652	89436	
S-22715	89436		S-4084	89430		S22311	85045		S29432	85323	89436
S-22862	85045		S-4089	83209	89414	S22312	85939		S29432	89436	
S-23013	85000	89436	S-4089	89414		S2232	85005	89430	S29678	85911	
S-23013	89436		S-4890	85712		S2232	89430		S29826	85338	
S-23014	85738		S10348	85043		S22345	85911		S33312	85338	
S-23290	83150		S14583	85000	89436	S2240	85013	89414	S33313	85338	
S-23315	85029		S14583	89436		S2240	89414		S33313L	85338	
S-23316	85382		S1667	85000	89436	S22715	85000	89436	S4084	85005	89430
S-23361	85911		S1667	89436		S22715	89436		S4084	89430	
S-23548	85079		S1668	85000	89436	S22862	85045		S4089	83209	89414
S-23566	85000	89436	S1668	89436		S23013	85000	89436	S4089	89414	
S-23566	89436		S20001	83389	89436	S23013	89436		S4890	85712	
S-23649	85064		S20001	89436		S23014	85738				
S-23650	85052		S20002	85000	89436	S23290	83150				

**Hendrickson Truck Suspension Systems**

Hendrickson truck suspension systems	Gabriel	Upgrade	Hendrickson truck suspension systems	Gabriel	Upgrade	Hendrickson truck suspension systems	Gabriel	Upgrade	Hendrickson truck suspension systems	Gabriel	Upgrade
060665-014	85962		47902-19	83123	89405	47902-8	83122	89406	4790222	89430	
060665-018	85961		47902-19	89405		47902-8	89406		4790224	83137	
060665014	85962		47902-20	85036	89405	47902-9	83123	89405	4790225	83125	
060675-016	85976		47902-20	89405		47902-9	89405		4790226	83144	
060675016	85976		47902-21	85976		4790211	83207	89407	4790227	83123	89405
12738	83225		47902-22	85916	89430	4790211	89407		4790227	89405	
471700000456	85959		47902-22	89430		4790213	83122	89406	4790228	85013	89414
471700006269	85932	89453	47902-24	83137		4790213	89406		4790228	89414	
471700006269	89453		47902-25	83125		4790215	83137		4790229	83149	
471700131545	85006		47902-26	83144		4790218	85030	89440	479023	85005	89430
47902-11	83207	89407	47902-27	83123	89405	4790218	89440		479023	89430	
47902-11	89407		47902-27	89405		4790219	83123	89405	479028	83122	89406
47902-13	83122	89406	47902-28	85013	89414	4790219	89405		479028	89406	
47902-13	89406		47902-28	89414		4790220	85036	89405			
47902-15	83137		47902-29	83149		4790220	89405				
47902-18	85030	89440	47902-3	85005	89430	4790221	85976				
47902-18	89440		47902-3	89430		4790222	85916	89430			

**Important Note:** Competitive Interchanges are to be used for stocking purposes only. Where multiple crosses are identified, please reference the applications section of this catalog. / **Remarque importante:** Les interchanges concurrentiels ne s'utilisent qu'aux fins de stocks. Dans le cas de rferences multiples, consulter la section des applications du catalogue. / **Nota importante:** Dans le cas de rferences multiples, consulter la section des applications du catalogue. / **Nota importante:** Se pueden usar intercambios competitivos para propósitos de almacenamiento solamente. Cuando se identifican intercambios múltiples, consulte la sección de aplicaciones de este catálogo.

**COMPETITIVE & O.E.M. INTERCHANGE LIST**  
**Lista de Intercambios contra Competidores y Equipo Original.**  
**Liste dinterchange de produits comptitifs & dquipement original (OEM)**

**Hendrickson Truck Suspension Systems... cont'd**

Hendrickson truck suspension systems	Gabriel	Upgrade	Hendrickson truck suspension systems	Gabriel	Upgrade	Hendrickson truck suspension systems	Gabriel	Upgrade	Hendrickson truck suspension systems	Gabriel	Upgrade
479029	83123	89405	58913003L	85932	89453	60665-005	85919		60670-013	83148	
479029	89405		58913003L	89453		60665-005L	85919		60670-014	83166	
503610C2	83207	89407	58913007	85959		60665-008	85978		60670-017	83148	
503610C2	89407		58913007L	85959		60665-009	85043		60670-018	83166	
5554596	85303	89422	58913008	85959		60665-011	85967		60670-019	83166	
5554596	89422		58913008L	85959		60665-013	85965		60670-020	83148	
57241-001	83111		58913009	85959		60665-014	85962		60670-12	83168	
57241-002	83109		58913009L	85959		60665-018	85961		60670001	83123	89405
57241-003	83112		58913011	85959		60665-018L	85961		60670001	89405	
57241-004	83110		58913011L	85959		60665-020	85919		60670002	83207	89407
57241-006	83111		58913012	85932	89453	60665-025	85036	89405	60670002	89407	
57241-006L	83111		58913012	89453		60665-025	89405		60670002L	83207	89407
57241001	83111		58913012L	85932	89453	60665-025L	85036	89405	60670002L	89407	
57241002	83109		58913012L	89453		60665-025L	89405		60670003	83149	
57241003	83112		58913015	85200		60665003	83137		60670004	83123	89405
57241004	83110		59048-001	83148		60665004	85036	89405	60670004	89405	
57241006	83111		59048001	83148		60665004	89405		60670005	83137	
57241006L	83111		59057-001	83137		60665004L	85036	89405	60670006	83147	
57324-1	85036	89405	59057-002	85036	89405	60665004L	89405		60670006L	83147	
57324-1	89405		59057-002	89405		60665005	85919		60670007	83144	
57324-11	85305		59057001	83137		60665005L	85919		60670007L	83144	
57324-2	85976		59057002	85036	89405	60665008	85978		60670008	83123	89405
57324-3	85916	89430	59057002	89405		60665009	85043		60670008	89405	
57324-3	89430		59305-1	85979		60665011	85967		60670008L	83123	89405
57324-6	85043		593051	85979		60665013	85965		60670008L	89405	
573241	85036	89405	59483-000	85919		60665014	85962		60670009	85013	89414
573241	89405		59483000	85919		60665018	85961		60670009	89414	
5732411	85305		59851-1	85976		60665018L	85961		60670010	83149	
573242	85976		598511	85976		60665020	85919		60670011	83148	
573243	85916	89430	59852-1	85977		60665025	85036	89405	60670012	83168	
573243	89430		59852-2	85977		60665025	89405		60670013	83148	
573246	85043		598521	85977		60665025L	85036	89405	60670014	83166	
57905-1	85976		598522	85977		60665025L	89405		60670017	83148	
579051	85976		60657-003	85072		60670-001	83123	89405	60670018	83166	
58623-1	85978		60657-003L	85072		60670-001	89405		60670019	83166	
586231	85978		60657-004	85072		60670-002	83207	89407	60670020	83148	
58913-003	85932	89453	60657-005	85087		60670-002	89407		6067012	83168	
58913-003	89453		60657-005L	85087		60670-002L	83207	89407	60675-001	85978	
58913-003L	85932	89453	60657-006	85102		60670-002L	89407		60675-001L	85978	
58913-003L	89453		60657-007	85072		60670-003	83149		60675-002	85979	
58913-007	85959		60657-010	85102		60670-004	83123	89405	60675-002L	85979	
58913-007L	85959		60657-011	85102		60670-004	89405		60675-003	85976	
58913-008	85959		60657003	85072		60670-005	83137		60675-003L	85976	
58913-008L	85959		60657003L	85072		60670-006	83147		60675-006	85909	
58913-009	85959		60657004	85072		60670-006L	83147		60675-006L	85909	
58913-009L	85959		60657005	85087		60670-007	83144		60675-007	83122	89406
58913-011	85959		60657005L	85087		60670-007L	83144		60675-007	89406	
58913-011L	85959		60657006	85102		60670-008	83123	89405	60675-009	85978	
58913-012	85932	89453	60657007	85072		60670-008	89405		60675-010	85036	89405
58913-012	89453		60657010	85102		60670-008L	83123	89405	60675-010	89405	
58913-012L	85932	89453	60657011	85102		60670-008L	89405		60675-013	83123	89405
58913-012L	89453		60665-003	83137		60670-009	85013	89414	60675-013	89405	
58913-015	85200		60665-004	85036	89405	60670-009	89414		60675-014	85978	
58913-015L	85200		60665-004	89405		60670-010	83149		60675-017	85979	
58913003	85932	89453	60665-004L	85036	89405	60670-011	83148		60675-12	85638	
58913003	89453		60665-004L	89405		60670-012	83168		60675001	85978	

**Important Note:** Competitive Interchanges are to be used for stocking purposes only. Where multiple crosses are identified, please reference the applications section of this catalog. / **Remarque importante:** Les interchanges concurrentiels ne s'utilisent qu'aux fins de stocks. Dans le cas de rfrences multiples, consulter la section des applications du catalogue. / **Nota importante:** Dans le cas de rfrences multiples, consulter la section des applications du catalogue. / **Nota importante:** Se pueden usar intercambios competitivos para propósitos de almacenamiento solamente. Cuando se identifican intercambios múltiples, consulte la sección de aplicaciones de este catálogo.

# COMPETITIVE & O.E.M. INTERCHANGE LIST

## Lista de Intercambios contra Competidores y Equipo Original.

### Liste dinterchange de produits comptitifs & dquipement original (OEM)

#### Hendrickson Truck Suspension Systems... cont'd

Hendrickson truck suspension systems	Gabriel	Upgrade	Hendrickson truck suspension systems	Gabriel	Upgrade	Hendrickson truck suspension systems	Gabriel	Upgrade	Hendrickson truck suspension systems	Gabriel	Upgrade
60675001L	85978		60685001	85977		654894	89405		671611	85955	
60675002	85979		60998-001	85006		654895	83137		671704	85043	
60675002L	85979		60998-002	85919		654896	83147		671764	85967	
60675003	85976		60998-002L	85919		654897	83144		671792	85965	
60675003L	85976		60998-003	85006		654898	83123	89405	671798	85962	
60675006	85909		60998001	85006		654898	89405		680091	85303	89422
60675006L	85909		60998002	85919		654899	85013	89414	680091	89422	
60675007	83122	89406	60998002L	85919		654899	89414		680600	85305	
60675007	89406		60998003	85006		654900	83149		70018	85303	89422
60675009	85978		64838-001	85933	89454	654903	83111		70018	89422	
60675010	85036	89405	64838-001	89454		654904	83109		70021	85303	89422
60675010	89405		64838-001L	85933	89454	654905	83112		70021	89422	
60675013	83123	89405	64838-001L	89454		659000	83148		70088	85307	
60675013	89405		64838-002	85933	89454	659004	83123	89405	98583-005	83168	
60675014	85978		64838-002	89454		659004	89405		98583-006	83148	
60675017	85979		64838-002L	85933	89454	659048	83143		98583-016	83147	
6067512	85638		64838-002L	89454		659049	83142		98583-032	85072	
606758Q	85976		64838-003	85933	89454	659155	83147		98583005	83168	
60680-001	83111		64838-003	89454		659202	83148		98583006	83148	
60680-001L	83111		64838-003L	85933	89454	659292	83148		98583016	83147	
60680-002	83109		64838-003L	89454		65992-001	85955		98583032	85072	
60680-003	83112		64838001	85933	89454	65992-002	85955		A-14496	646155	
60680-003L	83112		64838001	89454		65992-002L	85955		AE76164-3	85307	
60680-004	83143		64838001L	85933	89454	65992-003	85959		AE76164-4	83225	
60680-004L	83143		64838001L	89454		65992001	85955		AE761643	85307	
60680-005	83142		64838002	85933	89454	65992002	85955		AE761644	83225	
60680-005L	83142		64838002	89454		65992002L	85955		BE76164-2	85303	89422
60680001	83111		64838002L	85933	89454	65992003	85959		BE76164-2	89422	
60680001L	83111		64838002L	89454		665816	85072		BE76164-3	85307	
60680002	83109		64838003	85933	89454	665892	85072		BE76164-4	83225	
60680003	83112		64838003	89454		671006	85036	89405	BE761642	85303	89422
60680003L	83112		64838003L	85933	89454	671006	89405		BE761642	89422	
60680004	83143		64838003L	89454		671007	83137		BE761643	85307	
60680004L	83143		654890	83207	89407	671009	85919		BE761644	83225	
60680005	83142		654890	89407		671105	85072		HDR 58913 015	85200	
60680005L	83142		654891	83149		671603	85919				
60685-001	85977		654894	83123	89405	671606	85955				

#### Highway Product

Highway product	Gabriel	Upgrade	Highway product	Gabriel	Upgrade	Highway product	Gabriel	Upgrade	Highway product	Gabriel	Upgrade
A1-6-134	83207	89407	A1-6-135	83203	89436	A16134	83207	89407	A16135	83203	89436
A1-6-134	89407		A1-6-135	89436		A16134	89407		A16135	89436	

#### Hino

Hino	Gabriel	Upgrade	Hino	Gabriel	Upgrade	Hino	Gabriel	Upgrade	Hino	Gabriel	Upgrade
34802	83216		48500-1801	83216		48500-E0420	83391		485001940	83141	
48500-1120	85308	89422	48500-1940	83141		485001120	85308	89422	485001941	83141	
48500-1120	89422		48500-1941	83141		485001120	89422		485002240	85308	89422
48500-1140	85308	89422	48500-1950	G63610		485001140	85308	89422	485002240	89422	
48500-1140	89422		48500-2240	85308	89422	485001140	89422		485002280	85308	89422
48500-1340	85308	89422	48500-2240	89422		485001340	85308	89422	485002280	89422	
48500-1340	89422		48500-2280	85308	89422	485001340	89422		485002292	85308	89422
48500-1610	85308	89422	48500-2280	89422		485001610	85308	89422	485002292	89422	
48500-1610	89422		48500-2292	85308	89422	485001610	89422		485003710A	83126	89430
48500-1700	85308	89422	48500-2292	89422		485001700	85308	89422	485003710A	89430	
48500-1700	89422		48500-2750	G63610		485001700	89422				
48500-1730	85308	89422	48500-3710	83126	89430	485001730	85308	89422			
48500-1730	89422		48500-3710	89430		485001730	89422				
48500-1800	83216		48500-3720	83140		485001800	83216				

**Important Note:** Competitive Interchanges are to be used for stocking purposes only. Where multiple crosses are identified, please reference the applications section of this catalog. / **Remarque importante:** Les interchanges concurrentiels ne s'utilisent qu'aux fins de stocks. Dans le cas de rferences multiples, consulter la section des applications du catalogue. / **Nota importante:** Dans le cas de rferences multiples, consulter la section des aplicaciones du catalogue. / **Nota importante:** Se pueden usar intercambios competitivos para propósitos de almacenamiento solamente. Cuando se identifican intercambios múltiples, consulte la sección de aplicaciones de este catálogo.

**COMPETITIVE & O.E.M. INTERCHANGE LIST**  
**Lista de Intercambios contra Competidores y Equipo Original.**  
**Liste dinterchange de produits comptitifs & dquipement original (OEM)**

**Hino... cont'd**

Hino	Gabriel	Upgrade	Hino	Gabriel	Upgrade	Hino	Gabriel	Upgrade	Hino	Gabriel	Upgrade
485003720	83140		485301460	83215		6-031-7708-02	89422		60670012	83168	
48500E0420	83391		485301531	85308	89422	6-031-7708-03	85308	89422	60670013	83148	
48511-37320	83518		485301531	89422		6-031-7708-03	89422		60670014	83166	
48511-80162	83518		485301770	83215		6-071-4800-80	85308	89422	60670014L	83166	
4851137320	83518		485301800	85308	89422	6-071-4800-80	89422		60670018	83166	
4851180162	83518		485301800	89422		6-071-4800-81	85308	89422	60670018L	83166	
48530-1190	85308	89422	485301812	85308	89422	6-071-4800-81	89422		60670019	83166	
48530-1190	89422		485301812	89422		6031770800	85308	89422	60670019L	83166	
48530-1460	83215		485301880	83215		6031770800	89422		60670020	83148	
48530-1531	85308	89422	485302000	85308	89422	6031770801	85308	89422	60670029L	83166	
48530-1531	89422		485302000	89422		6031770801	89422		60670030	83166	
48530-1770	83215		48530E0100	83166		6031770802	85308	89422	60670030L	83166	
48530-1800	85308	89422	48530E0250	83137		6031770802	89422		60670031L	83166	
48530-1800	89422		48530E0290	83166		6031770803	85308	89422	6071480080	85308	89422
48530-1812	85308	89422	48530E0390	83166		6031770803	89422		6071480080	89422	
48530-1812	89422		48531-37350	83519		60670-012	83168		6071480081	85308	89422
48530-1880	83215		48531-37351	83519		60670-013	83148		6071480081	89422	
48530-1910	83216		48531-37361	83519		60670-014	83166		66639	G63610	
48530-2000	85308	89422	48531-37362	83519		60670-014L	83166		S4850-01941	83141	
48530-2000	89422		4853137350	83519		60670-018	83166		S4850-01950	G63610	
48530-2510	83216		4853137351	83519		60670-018L	83166		S4850-02750	G63610	
48530-E0100	83166		4853137361	83519		60670-019	83166		S4850-03710	83126	89430
48530-E0250	83137		4853137362	83519		60670-019L	83166		S4850-03710	89430	
48530-E0290	83166		6-031-7708-00	85308	89422	60670-020	83148		S4850-03720	83140	
48530-E0390	83166		6-031-7708-00	89422		60670-029L	83166		S485001941	83141	
48530-EW040	83166		6-031-7708-01	85308	89422	60670-030	83166		S485003720	83140	
485301190	85308	89422	6-031-7708-01	89422		60670-030L	83166		S4853-01910	83216	
485301190	89422		6-031-7708-02	85308	89422	60670-031L	83166		S4853-02510	83216	

**Hobbs Trailer**

Hobbs trailer	Gabriel	Upgrade	Hobbs trailer	Gabriel	Upgrade	Hobbs trailer	Gabriel	Upgrade	Hobbs trailer	Gabriel	Upgrade
680117	85300	89419	680117	89419							

**Holiday Rambler**

Holiday rambler	Gabriel	Upgrade	Holiday rambler	Gabriel	Upgrade	Holiday rambler	Gabriel	Upgrade	Holiday rambler	Gabriel	Upgrade
01809923	85029		8C2Z18125D	G63623		ASH-1161	85006		ASH-294	83209	89414
01809924	83144		90044794	83127		ASH-1162	85005	89430	ASH-294	89414	
01809925	85010		9U94-18045-AA	83209	89414	ASH-1162	89430		ASH1022	83209	89414
1C34-18045-AA	83209	89414	9U94-18045-AA	89414		ASH-1205	83209	89414	ASH1022	89414	
1C34-18045-AA	89414		9U94-18080-AA	83122	89406	ASH-1205	89414		ASH1023	83122	89406
1C34-18045-JA	83209	89414	9U94-18080-AA	89406		ASH-1206	83122	89406	ASH1023	89406	
1C34-18045-JA	89414		9U9418045AA	83209	89414	ASH-1206	89406		ASH1136	G63623	
1C3418045AA	83209	89414	9U9418045AA	89414		ASH-1228	83209	89414	ASH1154	G63622	
1C3418045AA	89414		9U9418080AA	83122	89406	ASH-1228	89414		ASH1161	85006	
1C3418045JA	83209	89414	9U9418080AA	89406		ASH-1229	83209	89414	ASH1162	85005	89430
1C3418045JA	89414		9U9Z-18124-A	83209	89414	ASH-1229	89414		ASH1162	89430	
24-153249	85125		9U9Z-18124-A	89414		ASH-1230	83122	89406	ASH1205	83209	89414
24-153256	85124		9U9Z-18125-A	83122	89406	ASH-1230	89406		ASH1205	89414	
24-186629	85125		9U9Z-18125-A	89406		ASH-137	83122	89406	ASH1206	83122	89406
24153249	85125		9U9Z18124A	83209	89414	ASH-137	89406		ASH1206	89406	
24153256	85124		9U9Z18124A	89414		ASH-25820	85005	89430	ASH1228	83209	89414
24186629	85125		9U9Z18125A	83122	89406	ASH-25820	89430		ASH1228	89414	
8C24-18045-DA	G63622		9U9Z18125A	89406		ASH-25821	85006		ASH1229	83209	89414
8C24-18080-DB	G63623		ASH-1022	83209	89414	ASH-25822	83209	89414	ASH1229	89414	
8C2418045DA	G63622		ASH-1022	89414		ASH-25822	89414		ASH1230	83122	89406
8C2418080DB	G63623		ASH-1023	83122	89406	ASH-25823	83209	89414			
8C2Z-18124-D	G63622		ASH-1023	89406		ASH-25823	89414				
8C2Z-18125-D	G63623		ASH-1136	G63623		ASH-25824	83122	89406			
8C2Z18124D	G63622		ASH-1154	G63622		ASH-25824	89406				

**Important Note:** Competitive Interchanges are to be used for stocking purposes only. Where multiple crosses are identified, please reference the applications section of this catalog. / **Remarque importante:** Les interchanges concurrentiels ne s'utilisent qu'aux fins de stocks. Dans le cas de rferences multiples, consulter la section des applications du catalogue. / **Nota importante:** Dans le cas de rferences multiples, consulter la section des applications du catalogue. / **Nota importante:** Se pueden usar intercambios competitivos para propósitos de almacenamiento solamente. Cuando se identifican intercambios múltiples, consulte la sección de aplicaciones de este catálogo.



**COMPETITIVE & O.E.M. INTERCHANGE LIST**  
**Lista de Intercambios contra Competidores y Equipo Original.**  
**Liste dinterchange de produits comptitifs & dquipement original (OEM)**

**Holiday Rambler... cont'd**

Holiday rambler	Gabriel	Upgrade	Holiday rambler	Gabriel	Upgrade	Holiday rambler	Gabriel	Upgrade	Holiday rambler	Gabriel	Upgrade
ASH1230	89406		ASH25824	89406		AT163G	G63622		F4-BE5-F325-HO	85124	
ASH137	83122	89406	ASH294	83209	89414	AT164G	G63623		F4BE5A832MO	85125	
ASH137	89406		ASH294	89414		AT620	83209	89414	F4BE5B492HO	85125	
ASH25820	85005	89430	AT-163G	G63622		AT620	89414		F4BE5F324HO	85125	
ASH25820	89430		AT-164G	G63623		AT621	83122	89406	F4BE5F325HO	85124	
ASH25821	85006		AT-620	83209	89414	AT621	89406		U0109-007	G63183	
ASH25822	83209	89414	AT-620	89414		AT766	83209	89414	U0109007	G63183	
ASH25822	89414		AT-621	83122	89406	AT766	89414		W0005662	85125	
ASH25823	83209	89414	AT-621	89406		F4-BE5-A832-MO	85125		W0005663	85124	
ASH25823	89414		AT-766	83209	89414	F4-BE5-B492-HO	85125		W0006254	85125	
ASH25824	83122	89406	AT-766	89414		F4-BE5-F324-HO	85125				

**Holland-Binkley**

Holland-binkley	Gabriel	Upgrade	Holland-binkley	Gabriel	Upgrade	Holland-binkley	Gabriel	Upgrade	Holland-binkley	Gabriel	Upgrade
680298	85321		6898	83125							

**Hutchens Suspension**

Hutchens suspension	Gabriel	Upgrade	Hutchens suspension	Gabriel	Upgrade	Hutchens suspension	Gabriel	Upgrade	Hutchens suspension	Gabriel	Upgrade
9423-00	83203	89436	9423-00	89436		942300	83203	89436	942300	89436	

**IC Corporation**

Ic corporation	Gabriel	Upgrade	Ic corporation	Gabriel	Upgrade	Ic corporation	Gabriel	Upgrade	Ic corporation	Gabriel	Upgrade
1660846C92	83101		3578105C2	83163		3902993C1	83135		501906C92	83317	
1675455C1	85003	89411	3578858C2	85656		3902993C2	83135		537524C91	83123	89405
1675455C1	89411		3601600C3	85082		3902993C3	83135		537524C91	89405	
2018987C1	85003	89411	3604282C1	85351		472412C91	83456	89447	6127088C1	83163	
2018987C1	89411		3605735C1	83169		472412C91	89447		6127713C1	85656	
2200327C1	85332		3605735C2	83169		501553C91	85003	89411	6127713C2	85656	
3533356C3	83169		3609400C1	83317		501553C91	89411		OE13402S	83163	
3578105C1	83163		3609400C2	83317		501906C91	83317		OE13424S	83317	

**Ingersall Machine**

Ingersall machine	Gabriel	Upgrade	Ingersall machine	Gabriel	Upgrade	Ingersall machine	Gabriel	Upgrade	Ingersall machine	Gabriel	Upgrade
665472	665472		665904	665472							

**Ingersoll Axles**

Ingersoll axles	Gabriel	Upgrade	Ingersoll axles	Gabriel	Upgrade	Ingersoll axles	Gabriel	Upgrade	Ingersoll axles	Gabriel	Upgrade
653511-01	85323	89436	653511-03	85045		65351101	89436		65351104	85052	
653511-01	89436		653511-04	85052		65351102	85938				
653511-02	85938		65351101	85323	89436	65351103	85045				

**International**

International	Gabriel	Upgrade	International	Gabriel	Upgrade	International	Gabriel	Upgrade	International	Gabriel	Upgrade
1201-0012	83023		12011043	83025		1202-1043	83025		1664788C2	85316	89426
1201-0154	83051		12011044	83025		1202-1044	83025		1664788C2	89426	
1201-0254	83051		12011049	83025		1202-1212	83013		1667520C1	85058	89431
1201-1043	83025		12011212	83013		1202-1213	83005		1667520C1	89431	
1201-1044	83025		12011213	83005		12020012	83023		1675455C1	85003	89411
1201-1049	83025		12019007	83054		12020032	83016		1675455C1	89411	
1201-1212	83013		12019008	83054		12020042	83025		1677707C1	85030	89440
1201-1213	83005		12019009	83054		12020043	83025		1677707C1	89440	
1201-9007	83054		12019010	83053		12020044	83025		1690035C1	85003	89411
1201-9008	83054		12019011	83053		12020054	83021		1690035C1	89411	
1201-9009	83054		12019013	83062		12021043	83025		2012768C1	83013	
1201-9010	83053		12019014	83062		12021044	83025		2012769C1	83005	
1201-9011	83053		12019018	83062		12021212	83013		2012769C2	83005	
1201-9013	83062		12019021	83062		12021213	83005		2015556C1	85316	89426
1201-9014	83062		1202-0012	83023		1660846C91	83101		2015556C1	89426	
1201-9018	83062		1202-0032	83016		1660846C92	83101		2015557C1	85030	89440
1201-9021	83062		1202-0042	83025		1663471C1	83103				
12010012	83023		1202-0043	83025		1663606C91	85027				
12010154	83051		1202-0044	83025		1664149C1	85029				
12010254	83051		1202-0054	83021		1664524C1	85935				

**Important Note:** Competitive Interchanges are to be used for stocking purposes only. Where multiple crosses are identified, please reference the applications section of this catalog. / **Remarque importante:** Les interchanges concurrentiels ne s'utilisent qu'aux fins de stocks. Dans le cas de rferences multiples, consulter la section des applications du catalogue. / **Nota importante:** Dans le cas de rferences multiples, consulter la section des applications du catalogue. / **Nota importante:** Se pueden usar intercambios competitivos para propósitos de almacenamiento solamente. Cuando se identifican intercambios múltiples, consulte la sección de aplicaciones de este catálogo.

**COMPETITIVE & O.E.M. INTERCHANGE LIST**  
**Lista de Intercambios contra Competidores y Equipo Original.**  
**Liste dinterchange de produits comptitifs & dquipement original (OEM)**

**International... cont'd**

International	Gabriel	Upgrade	International	Gabriel	Upgrade	International	Gabriel	Upgrade	International	Gabriel	Upgrade
2015557C1	89440		294334C91	83216		3558089C3	85648		3596107C4	85927	
2018987C1	85003	89411	3000070C91	83456	89447	3558989C1	85648		3596878C2	85648	
2018987C1	89411		3000070C91	89447		3558989C2	85648		3601600C1	85082	
2018987C2	85003	89411	3000098C1	83317		3560705C2	83054		3601600C2	85082	
2018987C2	89411		306444C91	85012	89413	3571711C1	85316	89426	3601600C3	85082	
2023684C1	83015		306444C91	89413		3571711C1	89426		3604282C1	85351	
2023685C1	83015		3085640C92	83216		3571713C1	85333		360444C91	85012	89413
2025790C1	83013		308646C91	85012	89413	3573265C1	85931	89458	360444C91	89413	
2029200C91	83126	89430	308646C91	89413		3573265C1	89458		3606770C1	83163	
2029200C91	85030	89440	308648C91	83225		3576464C1	85957		3606770C2	83163	
2029200C91	89430		308649C91	83216		3576464C2	85957		3606857C1	85954	
2029200C91	89440		308650C91	83216		3576465C1	85929		3606857C2	85954	
2032533C1	85316	89426	308650C92	83216		3576465C2	85929		3606857C3	85994	
2032533C1	89426		308664C91	85307		3578105C1	83163		3606859C1	85954	
2039549C1	85333		308668C91	85012	89413	3578105C2	83163		3606859C2	85954	
204994R91	83225		308668C91	89413		3578858C1	85656		3606859C3	85994	
206620R91	83216		308668C92	85012	89413	3578858C2	85656		3609178C1	85955	
206621R91	83216		308668C92	89413		3581106C1	85924	89457	3609400C1	83317	
206621R92	83216		308669C91	85012	89413	3581106C1	89457		3609400C2	83317	
208664C91	85307		308669C91	89413		3581106C2	85924	89457	3610198C1	85963	
210533R91	83225		320444C91	85012	89413	3581106C2	89457		3610199C1	85964	
210534R92	83225		320444C91	89413		3581106C3	85924	89457	3613984C1	85955	
210535R91	83225		329316C92	85012	89413	3581106C3	89457		3620395C1	85931	89458
210536R91	83225		329316C92	89413		3581107C1	85924	89457	3620395C1	89458	
210537R91	83225		3501427C1	619501		3581107C1	89457		3626571C1	85072	
210538R91	83225		350425C1	85300	89419	3581107C2	85924	89457	3626571C2	85072	
210918R91	83215		350425C1	89419		3581107C2	89457		3660548C1	85955	
210919R91	85307		350426C1	85734		3581107C3	85924	89457	3660549C1	85955	
210920R91	85308	89422	350426C91	85734		3581107C3	89457		3668566C1	85954	
210920R91	89422		3514952C1	85976		3581109C1	85924	89457	3670156C1	85954	
2200327C1	85332		3515265C1	83112		3581109C1	89457		3674348C1	85954	
2500013C1	83013		3515265C2	83112		3581109C3	85924	89457	3688614C1	85923	89458
2503529C1	83025		3533356C1	83135		3581109C3	89457		3688614C1	89458	
2507948C1	83054		3533356C2	83135		3581109C4	85924	89457	3688615C1	85931	89458
2508326C1	83021		3533356C3	83169		3581109C4	89457		3688615C1	89458	
2508327C1	83025		3533357C1	85957		3584116C1	83175		3688616C1	85923	89458
2509221C91	83054		3533357C2	85957		3584116C2	83175		3688616C1	89458	
2509222C91	83053		3533357C3	85957		3584117C1	83135		3688729C1	85931	89458
2509223C91	83054		3541456C1	85929		3584117C2	83135		3688729C1	89458	
2509223C92	83054		3544768C1	85656		3584118C1	85928		3688732C1	85931	89458
2509224C91	83053		3544768C2	85656		3584118C2	85928		3688732C1	89458	
2585145C1	83051		3549099C1	85923	89458	3584535C1	85924	89457	3737574C1	85954	
2589922C1	83051		3549099C1	89458		3584535C1	89457		3737575C1	85954	
2590915C1	83062		3549099C2	85923	89458	3584535C2	85924	89457	3737576C1	85931	89458
2590916C1	83062		3549099C2	89458		3584535C2	89457		3737576C1	89458	
2593803C91	83062		3549099C3	85923	89458	3584535C3	85924	89457	3806341C3	85995	
2595314C1	83062		3549099C3	89458		3584535C3	89457		3806341C4	85995	
2597458C91	83062		3549100C1	85656		3586883C1	85931	89458	3810581C3	85995	
2600491C91	83062		3553628C1	85927		3586883C1	89458		3810581C4	85995	
2601488C91	83062		3553628C2	85927		3586902C2	83364		3812837C1	85954	
2602021C1	83062		3553628C3	85927		3586902C3	83364		3813340C1	85964	
288920C91	83225		3553628C4	85927		3588209C1	85957		3813340C2	85964	
288921C91	83225		3557165C1	83053		3588209C2	85957		3813340C3	85964	
288921R92	83225		3557167C3	83053		3596107C1	85927		3813340C4	85964	
293009C91	85308	89422	3558089C1	85648		3596107C2	85927		3813341C1	85963	
293009C91	89422		3558089C2	85648		3596107C3	85927		3813341C2	85963	

**Important Note:** Competitive Interchanges are to be used for stocking purposes only. Where multiple crosses are identified, please reference the applications section of this catalog. / **Remarque importante:** Les interchanges concurrentiels ne s'utilisent qu'aux fins de stocks. Dans le cas de rfrences multiples, consulter la section des applications du catalogue. / **Nota importante:** Dans le cas de rfrences multiples, consulter la section des applications du catalogue. / **Nota importante:** Se pueden usar intercambios competitivos para propósitos de almacenamiento solamente. Cuando se identifican intercambios múltiples, consulte la sección de aplicaciones de este catálogo.

**COMPETITIVE & O.E.M. INTERCHANGE LIST**  
**Lista de Intercambios contra Competidores y Equipo Original.**  
**Liste dinterchange de produits comptitifs & dquipement original (OEM)**

**International... cont'd**

International	Gabriel	Upgrade	International	Gabriel	Upgrade	International	Gabriel	Upgrade	International	Gabriel	Upgrade
3813341C3	85963		4164155C1	89431		462753C91	83216		56110-T8123	G63432	
3813341C4	85963		4164156C1	85924	89457	463926C91	85705	89447	56110-T8129	G63432	
3816234C1	85929		4164156C1	89457		463926C91	89447		56110T8123	G63432	
3821760C1	85931	89458	4164161C1	85929		467371C91	83225		56110T8129	G63432	
3821760C1	89458		4170820C1	619501		467372C91	83225		57905-001	85976	
383379C91	83308		4205983C1	83397		467983C91	85012	89413	57905001	85976	
384435C91	83216		4206863C1	83398		467983C91	89413		586724C91	83456	89447
3868265C1	85995		4207304C1	83397		467984C91	83216		586724C91	89447	
3885832C1	83135		4208946C1	83398		467985C91	85012	89413	596329C1	85014	
3885832C2	83135		4211080C1	85957		467985C91	89413		60657-003	85072	
3892445C3	85931	89458	4212927C1	85929		471201C91	85012	89413	60657-003L	85072	
3892445C3	89458		4212932C1	85931	89458	471201C91	89413		60657-006	85102	
3892458C1	85656		4212932C1	89458		471203C91	83308		60657-010	85102	
3892458C2	85656		4212942C1	85639		472367C91	83318		60657-011	85102	
3902993C1	83135		4213758C1	85639		472411C91	83456	89447	60657003	85072	
3902993C3	83135		4213760C1	83163		472411C91	89447		60657003L	85072	
3914952C1	85976		4214011C2	85670		472412C91	83456	89447	60657006	85102	
3945165C1	83180		426744R91	85303	89422	472412C91	89447		60657010	85102	
3977759C2	85639		426744R91	89422		472414C91	83318		60657011	85102	
3983162C1	85639		426744R92	85303	89422	474002C91	83308		60665-013	85965	
3983162C2	85639		426744R92	89422		477132C1	85303	89422	60665013	85965	
3989717C1	83135		446-51-211	85739		477132C1	89422		60670-007	83144	
3991991C1	83135		44651211	85739		47902-24	83137		60670-007L	83144	
4050340C1	85931	89458	452566C91	83225		4790224	83137		60670007	83144	
4050340C1	89458		453527C91	85311	89424	4C4Z-18124-N	85957		60670007L	83144	
4050340C2	85931	89458	453527C91	89424		4C4Z-18125-DA	85656		60675-003	85976	
4050340C2	89458		453528C91	85311	89424	4C4Z18124N	85957		60675-003L	85976	
4050443C1	85994		453528C91	89424		4C4Z18125DA	85656		60675003	85976	
4050443C2	85994		453556C91	85012	89413	501506C91	83317		60675003L	85976	
4050444C1	85994		453556C91	89413		501553C91	85003	89411	60680-003	83112	
4050444C2	85994		453561C91	83225		501553C91	89411		60680-003L	83112	
4055574C2	83907		453562C91	83225		501905C91	83301		60680-004	83143	
4060267C4	83909		453564C91	85012	89413	501906C91	83317		60680-004L	83143	
4069426C1	85642		453564C91	89413		501906C92	83317		60680-005	83142	
4069434C1	85642		453565C91	83225		503550C1	83207	89407	60680-005L	83142	
4069435C1	85642		453566C91	83225		503550C1	89407		60680003	83112	
4070336C1	85058	89431	453567C91	83216		503610C1	83207	89407	60680003L	83112	
4070336C1	89431		453568C91	83225		503610C1	89407		60680004	83143	
4070352C1	85648		453569C91	83225		503610C2	83207	89407	60680004L	83143	
4072186C1	85928		453570C91	83216		503610C2	89407		60680005	83142	
4089293C1	83397		453571C91	83216		507202C1	85030	89440	60680005L	83142	
4109458C2	83243		453572C91	83309		507202C1	89440		6127086C1	85637	
4109582C1	83397		453574C91	85307		534464C1	85734		6127087C1	83364	
4109583C1	83397		453575C91	83308		537524C91	83123	89405	6127088C1	83163	
4164142C1	83244		453576C91	85303	89422	537524C91	89405		6127096C1	83180	
4164145C1	85672		453576C91	89422		537525C91	83123	89405	6127666C1	85642	
4164146C1	83169		453576C92	85303	89422	537525C91	89405		6127688C1	83169	
4164147C1	85671		453576C92	89422		540395C91	83613		6127690C1	85923	89458
4164148C1	85003	89411	453577C91	85308	89422	540395C92	83613		6127690C1	89458	
4164148C1	89411		453577C91	89422		548532C1	83103		6127700C1	83395	
4164149C1	85923	89458	453579C91	85308	89422	56101 Z1030	85311	89424	6127704C1	85670	
4164149C1	89458		453579C91	89422		56101 Z1030	89424		6127705C1	85924	89457
4164150C1	85995		462557C91	85300	89419	56101 Z2000	85311	89424	6127705C1	89457	
4164152C1	85924	89457	462557C91	89419		56101 Z2000	89424		6127713C1	85656	
4164152C1	89457		462603C91	85705	89447	56101 Z5008	83114		6127713C2	85656	
4164155C1	85058	89431	462603C91	89447		56101 Z5011	G63610		6127714C1	85928	

**Important Note:** Competitive Interchanges are to be used for stocking purposes only. Where multiple crosses are identified, please reference the applications section of this catalog. / **Remarque importante:** Les interchanges concurrentiels ne s'utilisent qu'aux fins de stocks. Dans le cas de rferences multiples, consulter la section des applications du catalogue. / **Nota importante:** Dans le cas de rferences multiples, consulter la section des applications du catalogue. / **Nota importante:** Se pueden usar intercambios competitivos para propósitos de almacenamiento solamente. Cuando se identifican intercambios múltiples, consulte la sección de aplicaciones de este catálogo.

**COMPETITIVE & O.E.M. INTERCHANGE LIST**  
**Lista de Intercambios contra Competidores y Equipo Original.**  
**Liste dinterchange de produits comptitifs & dquipement original (OEM)**

**International... cont'd**

International	Gabriel	Upgrade	International	Gabriel	Upgrade	International	Gabriel	Upgrade	International	Gabriel	Upgrade
65992-001	85955		874695R92	85012	89413	AMS650400	85033	89427	H60657003	85072	
65992-002	85955		874695R92	89413		AMS650400	89427		H60657006	85102	
65992-002L	85955		874696R91	85012	89413	AMS650402	85311	89424	H60657010	85102	
65992001	85955		874696R91	89413		AMS650402	89424		H60657011	85102	
65992002	85955		90044025	83209	89414	AMS650404	85310	89423	H60665013	85965	
65992002L	85955		90044025	89414		AMS650404	89423		H60675-003	85976	
66400	G63432		90044626	83126	89430	AMS650405	85023	89415	H60675003	85976	
6ETZ-18125-A	83364		90044626	89430		AMS650405	89415		H60680-003	83112	
6ETZ18125A	83364		AMS600102	85005	89430	AMS650406	85024		H60680003	83112	
70334	85316	89426	AMS600102	89430		AMS650408	85319	89428	H60680004	83143	
70334	89426		AMS600172	83126	89430	AMS650408	89428		HDR60680-005	83142	
790335C91	83209	89414	AMS600172	85005	89430	AMS650420	85013	89414	HDR60680005	83142	
790335C91	89414		AMS600172	85030	89440	AMS650420	89414		OE 18513	83135	
800670	85060		AMS600172	89430		AMS65145	85671		OE13402S	83163	
873619C92	83314		AMS600172	89440		AMS66161	83053		OE13424S	83317	
873619C93	83314		AMS650102	85001	89410	H60657-003	85072		OE14771	83062	
873622C91	83308		AMS650102	89410		H60657-006	85102		OE17103	83135	
874695R91	85012	89413	AMS650107	85316	89426	H60657-010	85102				
874695R91	89413		AMS650107	89426		H60657-011	85102				

**Isuzu**

Isuzu	Gabriel	Upgrade	Isuzu	Gabriel	Upgrade	Isuzu	Gabriel	Upgrade	Isuzu	Gabriel	Upgrade
1-51630-160-0	83162		8-22064-807-0	83136		8-98343986-0	83159		8982326720	83515	
1-51630-167-0	83613		8-22064232-0	85071		8-98380-746-0	83159		8982326721	83515	
1-51630-168-1	83515		8-22064233-0	83136		8-98380-747-0	83159		8983162280	83159	
1-51630-217-0	83114		8-22064804-0	83136		8-98381-010-0	83515		8983219121	85071	
1-51630-217-1	83114		8-22064805-0	83136		8-98381-012-0	83515		8983807460	83159	
1-51630-219-0	83114		8-94454-647-1	83515		8220642320	85071		8983807470	83159	
1-51630-219-1	83114		8-94454-986-0	83515		8220642330	83136		8983810100	83515	
12474915	83122	89406	8-94454-987-0	83515		8220648040	83136		8983810120	83515	
12474915	89406		8-97083-027-0	83515		8220648050	83136		9-51630-647-1	83515	
15123676	83136		8-97083-029-0	83515		8220648060	83136		9-51630-666-0	85012	89413
1516301600	83162		8-97253-616-0	83515		8220648070	83136		9-51630-666-0	89413	
1516301670	83613		8-97253-620-0	83515		88982682	83136		9-51630-666-2	85012	89413
1516301681	83515		8-97253-620-1	83515		88982686	85071		9-51630-666-2	89413	
15174902	85071		8-97253-621-0	83515		8944549870	83515		94454986	83515	
15887728	83136		8-97253-623-0	83515		8970830270	83515		94454987	83515	
19152843	83136		8-97253-651-2	83159		8970830290	83515		9516306660	85012	89413
5002465	83166		8-97253-664-0	83159		8972019600	83515		9516306660	89413	
51630168	83515		8-97253-665-0	83159		8972536160	83515		9516306662	85012	89413
51630217	83114		8-97517-966-0	83137		8972536200	83515		9516306662	89413	
51630219	83114		8-97517-966-1	83137		8972536201	83515		97083027	83515	
51630647	83515		8-98098-058-0	83159		8972536210	83515		97083029	83515	
51630666	85012	89413	8-98098-058-1	83159		8972536230	83515		97253620	83515	
51630666	89413		8-98098-059-0	83159		8975179660	83137		97253651	83159	
5872000750	83159		8-98098-059-1	83159		8975179661	83137		97253664	83159	
5872001100	83515		8-98098-125-0	83515		898098-0581	83159		97253665	83159	
60670-005	83137		8-98098-127-0	83515		898098-1250	83515		98098058	83159	
60670-005L	83137		8-98232671-0	83515		898098-1270	83515		98098059	83159	
60670005	83137		8-98232671-1	83515		8980980590	83159		98098125	83515	
60670005L	83137		8-98232672-0	83515		8980980591	83159		98098127	83515	
8-22064-233-0	83136		8-98232672-1	83515		8980981250	83515		98232671	83515	
8-22064-804-0	83136		8-98316-228-0	83159		8980981270	83515		98232672	83515	
8-22064-805-0	83136		8-98316227-0	83159		8982326710	83515		98316227	83159	
8-22064-806-0	83136		8-98321-912-1	85071		8982326711	83515		98343986	83159	

**Important Note:** Competitive Interchanges are to be used for stocking purposes only. Where multiple crosses are identified, please reference the applications section of this catalog. / **Remarque importante:** Les interchanges concurrentiels ne s'utilisent qu'aux fins de stocks. Dans le cas de références multiples, consulter la section des applications du catalogue. / **Nota importante:** Dans le cas de références multiples, consultar la sección des aplicaciones du catalogue. / **Nota importante:** Se pueden usar intercambios competitivos para propósitos de almacenamiento solamente. Cuando se identifican intercambios múltiples, consulte la sección de aplicaciones de este catálogo.

**COMPETITIVE & O.E.M. INTERCHANGE LIST**  
**Lista de Intercambios contra Competidores y Equipo Original.**  
**Liste dinterchange de produits compititifs & dquipement original (OEM)**

**Itasca**

Itasca	Gabriel	Upgrade	Itasca	Gabriel	Upgrade	Itasca	Gabriel	Upgrade	Itasca	Gabriel	Upgrade
141700131809	85029		66153002	89407		ASH-1228	83209	89414	AT-164G	G63623	
141700131810	83160		8C24-18045-DA	G63622		ASH-1228	89414		AT-620	83209	89414
16-16736-000	85029		8C24-18080-DB	G63623		ASH-1229	83209	89414	AT-620	89414	
16-16737-000	83160		8C2Z-18124-D	G63622		ASH-1229	89414		AT-621	83122	89406
16-16873-000	85029		8C2Z-18125-D	G63623		ASH-1230	83122	89406	AT-621	89406	
16-16874-000	83160		9U94-18045-AA	83209	89414	ASH-1230	89406		AT-766	83209	89414
16-18103-000	85900		9U94-18045-AA	89414		ASH-137	83122	89406	AT-766	89414	
1616736000	85029		9U94-18080-AA	83122	89406	ASH-137	89406		AT621	83122	89406
1616737000	83160		9U94-18080-AA	89406		ASH-25822	83209	89414	AT621	89406	
1616873000	85029		9U9418080AA	83122	89406	ASH-25822	89414		F4-BE5-A832-MO	85125	
1616874000	83160		9U9418080AA	89406		ASH-25823	83209	89414	F4-BE5-B492-HO	85125	
1618103000	85900		9U9Z-18124-A	83209	89414	ASH-25823	89414		F4-BE5-C832-MO	83124	89407
1C34-18045-AA	83209	89414	9U9Z-18124-A	89414		ASH-25824	83122	89406	F4-BE5-C832-MO	89407	
1C34-18045-AA	89414		9U9Z-18125-A	83122	89406	ASH-25824	89406		F4-BE5-F324-HO	85125	
1C34-18045-JA	83209	89414	9U9Z-18125-A	89406		ASH-294	83209	89414	F4-BE5-F325-HO	85124	
1C34-18045-JA	89414		9U9Z18125A	83122	89406	ASH-294	89414		F4BE5A832MO	85125	
24-153249	85125		9U9Z18125A	89406		ASH1023	83122	89406	F4BE5B492HO	85125	
24-153256	85124		ASH-1022	83209	89414	ASH1023	89406		F4BE5C832MO	83124	89407
24-186629	85125		ASH-1022	89414		ASH1206	83122	89406	F4BE5C832MO	89407	
24153249	85125		ASH-1023	83122	89406	ASH1206	89406		F4BE5F324HO	85125	
24153256	85124		ASH-1023	89406		ASH1230	83122	89406	F4BE5F325HO	85124	
24186629	85125		ASH-1136	G63623		ASH1230	89406		W0005662	85125	
481700000490	85900		ASH-1154	G63622		ASH137	83122	89406	W0005663	85124	
481700000493	85900		ASH-1205	83209	89414	ASH137	89406		W0006254	85125	
66153-002	83124	89407	ASH-1205	89414		ASH25824	83122	89406			
66153-002	89407		ASH-1206	83122	89406	ASH25824	89406				
66153002	83124	89407	ASH-1206	89406		AT-163G	G63622				

**Jay Madsen**

Jay madsen	Gabriel	Upgrade	Jay madsen	Gabriel	Upgrade	Jay madsen	Gabriel	Upgrade	Jay madsen	Gabriel	Upgrade
3166657	85700		3192333	85700							

**Jayco RV Inc.**

Jayco rv inc.	Gabriel	Upgrade	Jayco rv inc.	Gabriel	Upgrade	Jayco rv inc.	Gabriel	Upgrade	Jayco rv inc.	Gabriel	Upgrade
10-13976-000	85918	89449	16-16764-000	89443		ASH-1229	83209	89414	ASH-25823	89414	
10-13976-000	89449		1616764000	85724	89443	ASH-1229	89414		ASH-25824	83122	89406
1013976000	85918	89449	1616764000	89443		ASH-25822	83209	89414	ASH-25824	89406	
1013976000	89449		ASH-1136	G63623		ASH-25822	89414		ASH25824	83122	89406
16-16764-000	85724	89443	ASH-1154	G63622		ASH-25823	83209	89414	ASH25824	89406	

**Jifflox**

Jifflox	Gabriel	Upgrade	Jifflox	Gabriel	Upgrade	Jifflox	Gabriel	Upgrade	Jifflox	Gabriel	Upgrade
CP-5222	85315		CP5222	85315							

**John Deere**

John deere	Gabriel	Upgrade	John deere	Gabriel	Upgrade	John deere	Gabriel	Upgrade	John deere	Gabriel	Upgrade
3638112	G63183		4036892	G63605							

**Kenworth**

Kenworth	Gabriel	Upgrade	Kenworth	Gabriel	Upgrade	Kenworth	Gabriel	Upgrade	Kenworth	Gabriel	Upgrade
02-02736-2	85302	89420	02-02738-2	85012	89413	02-02741-2	85012	89413	0202736PLUS2	85302	89420
02-02736-2	89420		02-02738-2	89413		02-02741-2	89413		0202736PLUS2	89420	
02-02736PLUS	85302	89420	02-02738PLUS	85012	89413	02-02742-2	85062	89408	0202737PLUS	85062	89408
02-02736PLUS	89420		02-02738PLUS	89413		02-02742-2	89408		0202737PLUS	89408	
02-02736PLUS-2	85302	89420	02-02738PLUS-2	85012	89413	02-04010-2	85012	89413	0202738PLUS	85012	89413
02-02736PLUS-2	89420		02-02738PLUS-2	89413		02-04010-2	89413		0202738PLUS	89413	
02-02737-2	85062	89408	02-02739-2	85013	89414	02-0739PLUS-2	85013	89414	0202738PLUS2	85012	89413
02-02737-2	89408		02-02739-2	89414		02-0739PLUS-2	89414		0202738PLUS2	89413	
02-02737PLUS	85062	89408	02-02739PLUS	85013	89414	02027362	85302	89420			
02-02737PLUS	89408		02-02739PLUS	89414		02027362	89420				
02-02737PLUS-2	85062	89408	02-02740-2	85036	89405	0202736PLUS	85302	89420			
02-02737PLUS-2	89408		02-02740-2	89405		0202736PLUS	89420				

**Important Note:** Competitive Interchanges are to be used for stocking purposes only. Where multiple crosses are identified, please reference the applications section of this catalog. / **Remarque importante:** Les interchanges concurrentiels ne s'utilisent qu'aux fins de stocks. Dans le cas de rferences multiples, consulter la section des applications du catalogue. / **Nota importante:** Dans le cas de rferences multiples, consulter la section des applications du catalogue. / **Nota importante:** Se pueden usar intercambios competitivos para propósitos de almacenamiento solamente. Cuando se identifican intercambios múltiples, consulte la sección de aplicaciones de este catálogo.

**COMPETITIVE & O.E.M. INTERCHANGE LIST**  
**Lista de Intercambios contra Competidores y Equipo Original.**  
**Liste dinterchange de produits comptitifs & dquipement original (OEM)**

**Kenworth... cont'd**

Kenworth	Gabriel	Upgrade	Kenworth	Gabriel	Upgrade	Kenworth	Gabriel	Upgrade	Kenworth	Gabriel	Upgrade
02027392	85013	89414	10-12542-000PLUS	85901		16-13947-000PLUS	89428		60670-008	83123	89405
02027392	89414		1012032002PLUS	85320	89429	16-13947-000PLUS-2	85319	89428	60670-008	89405	
0202739PLUS	85013	89414	1012032002PLUS	89429		16-13947-000PLUS-2	89428		60670-008L	83123	89405
0202739PLUS	89414		1012032002PLUS2	85320	89429	1613947000PLUS	85319	89428	60670-008L	89405	
02027402	85036	89405	1012032002PLUS2	89429		1613947000PLUS	89428		60670-008PLUS	83123	89405
02027402	89405		1012542000PLUS	85901		1613947000PLUS2	85319	89428	60670-008PLUS	89405	
02027412	85012	89413	11418	646177		1613947000PLUS2	85319	89428	60670-008PLUS-2	83123	89405
02027412	89413		11418WAC	646177		1613947000PLUS2	89428		60670-008PLUS-2	89405	
02040102	85012	89413	1201-0012	83023		16725-01	83126	89430	60670004	83123	89405
02040102	89413		1201-1043	83025		16725-01	89430		60670004	89405	
020739PLUS2	85013	89414	1201-1044	83025		1672501	83126	89430	60670005	83137	
020739PLUS2	89414		1201-1046	83049		1672501	89430		60670005L	83137	
03-04176PLUS	85308	89422	1201-1264	83031		1707378PAC	85182		60670005PLUS	83137	
03-04176PLUS	89422		1201-8001	83908		19495-01	83126	89430	60670008	83123	89405
03-04176PLUS-2	85308	89422	1201-8002	83081		19495-01	89430		60670008	89405	
03-06084PLUS	85033	89427	12010012	83023		1949501	83126	89430	60670008L	83123	89405
03-06084PLUS	89427		12011043	83025		1949501	89430		60670008L	89405	
03-06084PLUS-2	85031		12011044	83025		2018987C1PLUS	85003	89411	60670008PLUS	83123	89405
03-06084PLUS-2	85033	89427	12011046	83049		2018987C1PLUS	89411		60670008PLUS	89405	
03-06084PLUS-2	89427		12011264	83031		2018987C1PLUS-2	85003	89411	60670008PLUS2	83123	89405
03-07421PLUS	85311	89424	12018001	83908		2018987C1PLUS-2	89411		60670008PLUS2	89405	
03-07421PLUS	89424		12018002	83081		2018987C1PLUS2	85003	89411	60675-017	85979	
03-07423-2	85033	89427	1202-0012	83023		2018987C1PLUS2	89411		60675017	85979	
03-07423-2	89427		1202-0032	83016		2027382	85012	89413	60680-004	83143	
03-07423PLUS	85033	89427	1202-0042	83025		2027382	89413		60680-004L	83143	
03-07423PLUS	89427		1202-0043	83025		25333002	83049		60680-005	83142	
03-07423PLUS-2	85033	89427	1202-0044	83025		25523002	83908		60680-005L	83142	
03-07423PLUS-2	89427		1202-0054	83021		25523013	83081		60680004	83143	
03-08350-2	85343		1202-1043	83025		25523024	83081		60680004L	83143	
03-08781	85069	89455	1202-1046	83049		3166657	85700		60680005	83142	
03-08781	89455		1202-1064	83024		471700004420	85109		60680005L	83142	
03-08781-2	85069	89455	1202-1065	83002		471700004423	85109		64178-001	83143	
03-08781-2	89455		1202-1164	83031		471700013186	85109		64178001	83143	
0304176PLUS	85308	89422	1202-1264	83031		47902-13PLUS	83122	89406	665092	83312	89409
0304176PLUS	89422		1202-1286	83056		47902-13PLUS	89406		665092	89409	
0306084PLUS	85033	89427	1202-K065	83002		47902-19	83123	89405	665118	83312	89409
0306084PLUS	89427		12020012	83023		47902-19	89405		665118	89409	
0306084PLUS2	85033	89427	12020032	83016		47902-24	83137		665174	85060	
0306084PLUS2	89427		12020042	83025		4790213PLUS	83122	89406	665331	85740	
0307421PLUS	85311	89424	12020043	83025		4790213PLUS	89406		665453	85001	89410
0307421PLUS	89424		12020044	83025		4790219	83123	89405	665453	89410	
03074232	85033	89427	12020054	83021		4790219	89405		665565	85007	
03074232	89427		12021043	83025		4790224	83137		665565PLUS	85007	
0307423PLUS	85033	89427	12021046	83049		60657-003	85072		665565PLUS-2	85007	
0307423PLUS	89427		12021064	83024		60657-003L	85072		665565PLUS2	85007	
0307423PLUS2	85033	89427	12021065	83002		60657003	85072		665617	85031	
0307423PLUS2	89427		12021164	83031		60657003L	85072		665617-2	85031	
03083502	85343		12021264	83031		60665-011	85967		6656172	85031	
0308781	85069	89455	12021286	83056		60665-013	85965		665632	85013	89414
0308781	89455		1202K046	83049		60665011	85967		665632	89414	
03087812	85069	89455	1202K064	83024		60665013	85965		665633	85033	89427
03087812	89455		1202K065	83002		60670-004	83123	89405	665633	89427	
10-12032-002PLUS	85320	89429	1202K164	83031		60670-004	89405		665670	85001	89410
10-12032-002PLUS	89429		1202K264	83031		60670-005	83137		665670	89410	
10-12032-002PLUS-2	85320	89429	1202K286	83056		60670-005L	83137		665680	83312	89409
10-12032-002PLUS-2	89429		16-13947-000PLUS	85319	89428	60670-005PLUS	83137		665680	89409	
						60670-005PLUS-2	83137				

**Important Note:** Competitive Interchanges are to be used for stocking purposes only. Where multiple crosses are identified, please reference the applications section of this catalog. / **Remarque importante:** Les interchanges concurrentiels ne s'utilisent qu'aux fins de stocks. Dans le cas de références multiples, consulter la section des applications du catalogue. / **Nota importante:** Dans le cas de referencias multiples, consultar la sección de aplicaciones del catálogo. / **Nota importante:** Se pueden usar intercambios competitivos para propósitos de almacenamiento solamente. Cuando se identifican intercambios múltiples, consulte la sección de aplicaciones de este catálogo.

**COMPETITIVE & O.E.M. INTERCHANGE LIST**  
**Lista de Intercambios contra Competidores y Equipo Original.**  
**Liste dinterchange de produits comptitifs & dquipement original (OEM)**

**Kenworth... cont'd**

Kenworth	Gabriel	Upgrade	Kenworth	Gabriel	Upgrade	Kenworth	Gabriel	Upgrade	Kenworth	Gabriel	Upgrade
665738-2	85910		671962SPL	89456		90044089PLUS-2	89407		B711003	83312	89409
665783	83123	89405	671963	85937		90045099	85906	89407	B711003	89409	
665783	89405		671963-2	85937		90045099	89407		B716000	85959	
665784	83122	89406	675122	85001	89410	90045132	85909		B716002	85012	89413
665784	89406		675122	89410		90045605	85109		B716002	89413	
665785	83137		680237	85303	89422	90045803	85109		B716003	85029	
665788	85000	89436	680237	89422		90045812	85109		B716004	85084	89460
665788	89436		680239	85310	89423	96027-10545	83011		B716004	89460	
665788-2	85000	89436	680239	89423		9602710545	83011		B716005	85084	89460
665788-2	89436		680240	85302	89420	ACHB966	83136		B716005	89460	
665828	85067	89451	680240	89420		B71-1000	85031		B716006	85084	89460
665828	89451		680241	85311	89424	B71-1001	85070	89459	B716006	89460	
665844	85069	89455	680241	89424		B71-1001	89459		B716007	85062	89408
665844	89455		680242	85308	89422	B71-1002	85001	89410	B716007	89408	
665858	85070	89459	680242	89422		B71-1002	89410		B716008	83312	89409
665858	89459		680253	85314	89425	B71-1003	83312	89409	B716008	89409	
665858-2	85070	89459	680253	89425		B71-1003	89409		B716010	85023	89415
665858-2	89459		680261	85062	89408	B71-6000	85959		B716010	89415	
6658582	85070	89459	680261	89408		B71-6000-2	85959		B716011	85062	89408
6658582	89459		680261-2	85062	89408	B71-6002	85012	89413	B716011	89408	
665903	85900		680261-2	89408		B71-6002	89413		B716012	85119	
665906	85902		680279	83209	89414	B71-6002-2	85012	89413	B716013	85012	89413
665918	85900		680279	89414		B71-6002-2	89413		B716013	89413	
665926	85047	89435	680280	85906	89407	B71-6003	85029		B716015	85012	89413
665926	89435		680280	89407		B71-6003-2	85029		B716015	89413	
665927	85901		680281	85003	89411	B71-6004	85084	89460	B716016	85012	89413
665928	85062	89408	680281	89411		B71-6004	89460		B716016	89413	
665928	89408		680283	85740		B71-6005	85084	89460	B716017	85910	
665930	85001	89410	680303	85007		B71-6005	89460		B716018	85012	89413
665930	89410		680425	85320	89429	B71-6006	85084	89460	B716018	89413	
665931	83312	89409	680425	89429		B71-6006	89460		B716019	85989	
665931	89409		680435	85033	89427	B71-6007	85062	89408	B716020	85989	
665932	85012	89413	680435	89427		B71-6007	89408		BFRG 072	85182	
665932	89413		680473	85319	89428	B71-6008	83312	89409	C71-1002	85067	89451
665944	85900		680473	89428		B71-6008	89409		C71-1002	89451	
665944-2	85900		680475	85314	89425	B71-6010	85023	89415	C71-1002-2	85067	89451
665945	85902		680475	89425		B71-6010	89415		C71-1002-2	89451	
665945-2	85902		680476	85310	89423	B71-6011	85062	89408	C71-1002PLUS	85067	89451
665950	85902		680476	89423		B71-6011	89408		C71-1002PLUS	89451	
671052	85070	89459	680486	85310	89423	B71-6012	85119		C71-1002PLUS-2	85067	89451
671052	89459		680486	89423		B71-6013	85012	89413	C71-1002PLUS-2	89451	
671052-2	85070	89459	680586	85311	89424	B71-6013	89413		C71-1011	85069	89455
671052-2	89459		680586	89424		B71-6015	85012	89413	C71-1011	89455	
6710522	85070	89459	70701	85900		B71-6015	89413		C71-1011PLUS	85069	89455
6710522	89459		70701PLUS	85900		B71-6016	85012	89413	C71-1011PLUS	89455	
671654	85936	89456	70701PLUS-2	85900		B71-6016	89413		C71-1011PLUS-2	85069	89455
671654	89456		800670	85060		B71-6017	85910		C71-1011PLUS-2	89455	
671656	85985		8086053PLUS	85047	89435	B71-6018	85012	89413	C71-1011SPL	85069	89455
671699	85937		8086053PLUS	89435		B71-6018	89413		C71-1011SPL	89455	
671794	85067	89451	90044025PLUS	83209	89414	B71-6019	85989		C71-1013	85985	
671794	89451		90044025PLUS	89414		B71-6020	85989		C71-1014	85936	89456
671962	85936	89456	90044089	83124	89407	B711000	85031		C71-1014	89456	
671962	89456		90044089	89407		B711001	85070	89459	C71-1015	85937	
671962PLUS	85936	89456	90044089PLUS	83124	89407	B711001	89459		C71-1015 PLUS	85937	
671962PLUS	89456		90044089PLUS	89407		B711002	85001	89410	C71-1015A	85937	
671962SPL	85936	89456	90044089PLUS-2	83124	89407	B711002	89410		C71-1016	85067	89451

**Important Note:** Competitive Interchanges are to be used for stocking purposes only. Where multiple crosses are identified, please reference the applications section of this catalog. / **Remarque importante:** Les interchanges concurrentiels ne s'utilisent qu'aux fins de stocks. Dans le cas de rferences multiples, consulter la section des applications du catalogue. / **Nota importante:** Dans le cas de rferences multiples, consulter la section des applications du catalogue. / **Nota importante:** Se pueden usar intercambios competitivos para propósitos de almacenamiento solamente. Cuando se identifican intercambios múltiples, consulte la sección de aplicaciones de este catálogo.



**COMPETITIVE & O.E.M. INTERCHANGE LIST**  
**Lista de Intercambios contra Competidores y Equipo Original.**  
**Liste dinterchange de produits comptitifs & dquipement original (OEM)**

**Kenworth... cont'd**

Kenworth	Gabriel	Upgrade	Kenworth	Gabriel	Upgrade	Kenworth	Gabriel	Upgrade	Kenworth	Gabriel	Upgrade
C71-1016	89451		K374-13-1	85740		K374-5	83312	89409	K37432	85310	89423
C71-1017	85069	89455	K374-14	83312	89409	K374-5	89409		K37432	89423	
C71-1017	89455		K374-14	89409		K374-7	85310	89423	K374322	85310	89423
C71-6000-2	85067	89451	K374-16	85001	89410	K374-7	89423		K374322	89423	
C71-6000-2	89451		K374-16	89410		K374-9	85310	89423	K37433	83312	89409
C71-6003	85988		K374-26	85001	89410	K374-9	89423		K37433	89409	
C71-6004	85343		K374-26	89410		K374-C31	83312	89409	K37433PLUS	83312	89409
C71-6005	85069	89455	K374-26-2	85001	89410	K374-C31	89409		K37433PLUS	89409	
C71-6005	89455		K374-26-2	89410		K374-C7	85310	89423	K3744	85314	89425
C71-6015	85067	89451	K374-26PLUS	85001	89410	K374-C7	89423		K3744	89425	
C71-6015	89451		K374-26PLUS	89410		K37410	83215		K3745	83312	89409
C711002	85067	89451	K374-26PLUS-2	85001	89410	K374102	83215		K3745	89409	
C711002	89451		K374-26PLUS-2	89410		K37411	85001	89410	K3747	85310	89423
C7110022	85067	89451	K374-27	85001	89410	K37411	89410		K3747	89423	
C7110022	89451		K374-27	89410		K37413	85740		K3749	85310	89423
C711002PLUS	85067	89451	K374-27-2	85001	89410	K374131	85740		K3749	89423	
C711002PLUS	89451		K374-27-2	89410		K37414	83312	89409	K374C31	83312	89409
C711002PLUS2	85067	89451	K374-28	85314	89425	K37414	89409		K374C31	89409	
C711002PLUS2	89451		K374-28	89425		K37416	85001	89410	K374C7	85310	89423
C711011	85069	89455	K374-28-2	85314	89425	K37416	89410		K374C7	89423	
C711011	89455		K374-28-2	89425		K37426	85001	89410	PP1058870	83059	
C711011PLUS	85069	89455	K374-28PLUS	85314	89425	K37426	89410		PP2582870	83012	
C711011PLUS	89455		K374-28PLUS	89425		K374262	85001	89410	R71-1004	83049	
C711011PLUS2	85069	89455	K374-29	85310	89423	K374262	89410		R71-1005	83024	
C711011PLUS2	89455		K374-29	89423		K37426PLUS	85001	89410	R71-6005	83042	
C711011SPL	85069	89455	K374-29-2	85310	89423	K37426PLUS	89410		R71-6007	83008	
C711011SPL	89455		K374-29-2	89423		K37426PLUS2	85001	89410	R71-6008	83035	
C711013	85985		K374-29PLUS	85310	89423	K37426PLUS2	89410		R71-6009	83081	
C711014	85936	89456	K374-29PLUS	89423		K37427	85001	89410	R711004	83049	
C711014	89456		K374-29PLUS-2	85310	89423	K37427	89410		R711005	83024	
C711015	85937		K374-29PLUS-2	89423		K374272	85001	89410	R716005	83042	
C711015 PLUS	85937		K374-3	83312	89409	K374272	89410		R716007	83008	
C711015A	85937		K374-3	89409		K37428	85314	89425	R716008	83035	
C711016	85067	89451	K374-3-1	83312	89409	K37428	89425		R716009	83081	
C711016	89451		K374-3-1	89409		K374282	85314	89425	S-20126	85323	89436
C711017	85069	89455	K374-32	85310	89423	K374282	89425		S-20126	89436	
C711017	89455		K374-32	89423		K37428PLUS	85314	89425	S20126	85323	89436
C7160002	85067	89451	K374-32-2	85310	89423	K37428PLUS	89425		S20126	89436	
C7160002	89451		K374-32-2	89423		K37429	85310	89423	T71-1000	83031	
C716003	85988		K374-33	83312	89409	K37429	89423		T71-1001	83031	
C716004	85343		K374-33	89409		K374292	85310	89423	T71-1002	83002	
C716005	85069	89455	K374-33-2	83312	89409	K374292	89423		T71-1003	83056	
C716005	89455		K374-33-2	89409		K37429PLUS	85310	89423	T711000	83031	
C716015	85067	89451	K374-33PLUS	83312	89409	K37429PLUS	89423		T711001	83031	
C716015	89451		K374-33PLUS	89409		K37429PLUS2	85310	89423	T711002	83002	
K374-10	83215		K374-33PLUS-2	83312	89409	K37429PLUS2	89423		T711003	83056	
K374-10-2	83215		K374-33PLUS-2	89409		K3743	83312	89409	TK19679	83126	89430
K374-11	85001	89410	K374-36	89432		K3743	89409		TK19679	89430	
K374-11	89410		K374-4	85314	89425	K37431	83312	89409			
K374-13	85740		K374-4	89425		K37431	89409				

**Kimble Mixer Co.**

Kimble mixer co.	Gabriel	Upgrade	Kimble mixer co.	Gabriel	Upgrade	Kimble mixer co.	Gabriel	Upgrade	Kimble mixer co.	Gabriel	Upgrade
OE10455	646155		T91-00002-00	646155		Kimble mixer co.	646155		Kimble mixer co.		

**King Of The Road**

King of the road	Gabriel	Upgrade	King of the road	Gabriel	Upgrade	King of the road	Gabriel	Upgrade	King of the road	Gabriel	Upgrade
141700131809	85029		16-16736-000	85029							
141700131810	83160		16-16737-000	83160							

**Important Note:** Competitive Interchanges are to be used for stocking purposes only. Where multiple crosses are identified, please reference the applications section of this catalog. / **Remarque importante:** Les interchanges concurrentiels ne s'utilisent qu'aux fins de stocks. Dans le cas de rfrences multiples, consulter la section des applications du catalogue. / **Nota importante:** En el caso de rfrences multiples, consultar la seccion de aplicaciones del catalogo. / **Nota importante:** Se pueden usar intercambios competitivos para propósitos de almacenamiento solamente. Cuando se identifican intercambios múltiples, consulte la sección de aplicaciones de este catálogo.

**COMPETITIVE & O.E.M. INTERCHANGE LIST**  
**Lista de Intercambios contra Competidores y Equipo Original.**  
**Liste d'interchange de produits complitifs & d'equipement original (OEM)**

**King Of The Road... cont'd**

King of the road	Gabriel	Upgrade	King of the road	Gabriel	Upgrade	King of the road	Gabriel	Upgrade	King of the road	Gabriel	Upgrade
16-16873-000	85029		1616736000	85029		1616874000	83160		481700000493	85900	
16-16874-000	83160		1616737000	83160		1618103000	85900				
16-18103-000	85900		1616873000	85029		481700000490	85900				

**Koni**

Koni	Gabriel	Upgrade	Koni	Gabriel	Upgrade	Koni	Gabriel	Upgrade	Koni	Gabriel	Upgrade
090-2209-SP2	89410		88-1457-SP1	83209	89414	88-5162	83209	89414	90-2059	85722	
30-1348	G63424		88-1457-SP1	89414		88-5162	89414		90-2060	85722	
30-1350	G63511		88-1458-SP1	83122	89406	88-5163	83122	89406	90-2102-SP1	85708	
30-1351	G63490		88-1458-SP1	89406		88-5163	89406		90-2148	85304	
30-1365	G63611		88-1458-SP2	83122	89406	8805-1001	85125		90-2164-SP1	85723	
30-1366	G63610		88-1458-SP2	89406		8805-1002	85124		90-2209	85308	89422
30-1381	G63426		88-1468	83209	89414	8805-1018	83209	89414	90-2209	89422	
30-1421	G63547		88-1468	89414		8805-1018	89414		90-2209-SP2	85001	89410
30-1422	G63548		88-1476	85740		8805-1019	83122	89406	90-2209-SP2	89410	
30-1456	G63782		88-1489	85036	89405	8805-1019	89406		90-2253-SP2	85732	
30-1457	G63781		88-1489	89405		8805-1020	83160		90-2254	85720	
30-1501	G63608		88-1490	83124	89407	8805-1022	85724	89443	90-2256	85732	
30-1502	G63679		88-1490	89407		8805-1022	89443		90-2257	85716	
30-1565	G63707		88-1499	85001	89410	8805-1023	83136		90-2325	85340	
30-1566	G63708		88-1499	89410		8805-1042	G63622		90-2326	85970	
30-1606	G63423		88-1509	85027		8805-1043	G63623		90-2327	85341	
30-1607	G63422		88-1510	85708		8850-1002	G63622		90-2396-SP1	85000	89436
30-1614	G63678		88-1517	85040		90-1409-SP1	85722		90-2396-SP1	85323	89436
30-1624	G63424		88-1518	85040		90-1577-SP1	85310	89423	90-2396-SP1	89436	
30-1627	G63690		88-1520	85040		90-1577-SP1	89423		90-2407	85709	
30-1630	G63425		88-1525	85040		90-1811	85301		90-2434	85702	
30-1630	G63722		88-1532	85708		90-1813-SP1	85712		90-2477	85900	
80-2516	G63421		88-1540	85051		90-1862	85708		90-2478	85902	
80-2517	G63422		88-1541	85045		90-1867	85053	89442	90-2497S-P1	85712	
80-2633	G63423		88-1558	85013	89414	90-1867	89442		90-2563	85006	
80-2634	G63422		88-1558	89414		90-1868	85307		90-2572	85329	
82-1952	G63347		88-1559-SP1	85036	89405	90-1868-SP1	85307		90-2573	85329	
82-1954	G63355		88-1559-SP1	89405		90-1896	85302	89420	90-2575	85700	
82-1955	G63349		88-1560	85062	89408	90-1896	89420		90-2576	85700	
82-1970	G63350		88-1560	89408		90-1897	85303	89422	90-2586	85728	
82-2158	G63357		88-1561	85012	89413	90-1897	89422		90-2587	85729	
82-2246	G63299		88-1561	89413		90-1898	83215		90-2588	85339	
82-2345	G63413		88-1562	85003	89411	90-1907-SP1	85300	89419	90-2589	85727	
82-2372	G63609		88-1562	89411		90-1907-SP1	89419		90-2816	85711	
82-2384	G63488		88-1616	85014		90-1908-SP1	85723		90-5055-SP2	85318	
8240-1029	G63386		88-1639	83130		90-1909-SP1	85722		90-5180	85300	89419
8240-1054	G63375		88-1641	85029		90-1910	85704		90-5180	89419	
8240-1055	G63454		88-1641SP3	85029		90-1912	85318		9005-1018	85970	
8240-1148	G63720		88-1642	83124	89407	90-1922	85900		9005-1019	85341	
84-1168	83130		88-1642	89407		90-1943	85307		9020-1042	85708	
88-1385	83105		88-1644	85000	89436	90-1951-SP1	85734		90F-1235	85700	
88-1417	83312	89409	88-1644	89436		90-1951-SP5	85712		92-1227	85722	
88-1417	89409		88-1646	83613		90-1965	85304		99B-3254	85029	
88-1419	83136		88-1647	83317		90-1968	85720				
88-1422	85030	89440	88-1704	85030	89440	90-1974	85311	89424			
88-1422	89440		88-1704	89440		90-1974	89424				

**Krystal Bus**

Krystal bus	Gabriel	Upgrade	Krystal bus	Gabriel	Upgrade	Krystal bus	Gabriel	Upgrade	Krystal bus	Gabriel	Upgrade
ASH-1136	G63623		ASH-1154	G63622		ASH1136	G63623		ASH1154	G63622	

**Important Note:** Competitive Interchanges are to be used for stocking purposes only. Where multiple crosses are identified, please reference the applications section of this catalog. / **Remarque importante:** Les interchanges concurrentiels ne s'utilisent qu'aux fins de stocks. Dans le cas de références multiples, consulter la section des applications du catalogue. / **Nota importante:** Dans le cas de referencias multiples, consultar la sección de aplicaciones del catálogo. / **Nota importante:** Se pueden usar intercambios competitivos para propósitos de almacenamiento solamente. Cuando se identifican intercambios múltiples, consulte la sección de aplicaciones de este catálogo.

**COMPETITIVE & O.E.M. INTERCHANGE LIST**  
**Lista de Intercambios contra Competidores y Equipo Original.**  
**Liste dinterchange de produits comptitifs & dquipement original (OEM)**

**KWK-LOC (JIFFLOX)**

Kwk-loc (jifflox)	Gabriel	Upgrade	Kwk-loc (jifflox)	Gabriel	Upgrade	Kwk-loc (jifflox)	Gabriel	Upgrade	Kwk-loc (jifflox)	Gabriel	Upgrade
522217	85315		CP-5222	85315		CP5222	85315				

**KYB**

Kyb	Gabriel	Upgrade	Kyb	Gabriel	Upgrade	Kyb	Gabriel	Upgrade	Kyb	Gabriel	Upgrade
232027	G55772		332113	G56530		333605	G52094		334431	G56798	
234035	G55591		3330052	G52155		333617	G52440		334432	G52169	
234036	G55591		3330053	G52154		333618	G52439		334433	G52168	
234057	G55999		333111	G56571		333781	G56641		334440	G56671	
234058	G55999		333111	G56637		333782	G56640		334441	G56672	
234059	G55662		333114	G55999		3340049	G52173		334450	G56660	
234060	G55661		333115	G55999		3340050	G52174		334451	G56661	
234061	G55911		333116	G55662		3340063	G52081		334452	G52106	
234062	G55911		333117	G55661		3340064	G52082		334453	G52105	
235005	G55551		333118	G55591		3340128	G56843		334454	G52033	
235060	G55681		333119	G55591		3340129	G56842		334455	G52032	
235619	G55856		333205	G56540		3340158	G52411		334464	G52185	
235624	G55994		333206	G56539		3340159	G52410		334465	G52184	
235625	G55993		333207	G52336		3340213	G52495		334472	G56843	
235626	G55896		333208	G52335		3340214	G52494		334473	G56842	
235627	G55892		333224	G56529		3340249	G52149		334478	G55676	
235630	G56635		333225	G56530		3340250	G52148		334479	G55675	
235631	G56636		333236	G55999		334133	G55676		334500	G56561	
235703	G52014		333237	G55999		334134	G55675		334501	G56562	
235704	G52013		333264	G52018		334169	G55901		334502	G56820	
235906	G56735		333265	G52017		334188	G55697		334503	G56819	
235907	G56734		333274	G56633		334227	G55948		334504	G56821	
235912	G56568		333275	G56634		334228	G55949		334505	G56822	
235913	G56601		333276	G56537		334245	G56514		334506	G52159	
235920	G56817		333277	G56538		334246	G56506		334507	G52158	
235921	G56655		333316	G56893		334294	G55901		334508	G52248	
235950	G55892		333317	G56892		334316	G55698		334509	G52247	
235951	G55892		333318	G56529		334333	G56568		334611	G56802	
236001	G56700		333319	G56530		334334	G56601		334621	G52165	
236002	G56701		333331	G52283		334335	G56620		334621	G52298	
236007	G56718		333332	G52282		334336	G56672		334622	G52164	
331008	G56622		333348	G56517		334337	G56671		334622	G52297	
331009	G56621		333349	G56516		334364	G56758		334636	G52111	
331016	G51718		333350	G56633		334365	G56759		334637	G52110	
331017	G51728		333351	G56634		334380	G52009		334642	G52082	
331021	G56622		333382	G56894		334381	G52008		334643	G52081	
331022	G56621		333385	G52098		334384	G56735		334644	G56841	
331035	G56799		333417	G56887		334385	G56734		334645	G56840	
331036	G56800		333418	G56886		334386	G56722		334652	G52130	
331037	G56799		333461	G56809		334387	G56721		334653	G52129	
331038	G56800		333462	G56809		334388	G56729		334658	G52082	
331039	G52113		333474	G52283		334389	G56728		334659	G52081	
331040	G52112		333475	G52282		334394	G56733		334673	G52131	
331043	G51718		333490	G52161		334395	G56732		334684	G52281	
331046	G52113		333491	G52160		334399	G56680		334685	G52280	
331047	G52112		333492	G52163		334399	G56731		334686	G52396	
331048	G56799		333493	G52162		334400	G56679		334687	G52395	
331049	G56800		333500	G56641		334400	G56730		334688	G52176	
331050	G56799		333501	G56640		334420	G56894		334689	G52175	
331051	G56800		333516	G52155		334428	G56680		334692	G52352	
331613	G52349		333517	G52154		334429	G56679				
331614	G52348		333602	G52095		334430	G52107				
3320043	G55911		333603	G52094		334430	G56797				
332112	G56529		333604	G52095		334431	G52108				

**Important Note:** Competitive Interchanges are to be used for stocking purposes only. Where multiple crosses are identified, please reference the applications section of this catalog. / **Remarque importante:** Les interchanges concurrentiels ne s'utilisent qu'aux fins de stocks. Dans le cas de rfrences multiples, consulter la section des applications du catalogue. / **Nota importante:** Dans le cas de rfrences multiples, consulter la section des applications du catalogue. / **Nota importante:** Se pueden usar intercambios competitivos para propósitos de almacenamiento solamente. Cuando se identifican intercambios múltiples, consulte la sección de aplicaciones de este catálogo.

**COMPETITIVE & O.E.M. INTERCHANGE LIST**  
**Lista de Intercambios contra Competidores y Equipo Original.**  
**Liste dinterchange de produits comptitifs & dquipement original (OEM)**

**KYB... cont'd**

Kyb	Gabriel	Upgrade	Kyb	Gabriel	Upgrade	Kyb	Gabriel	Upgrade	Kyb	Gabriel	Upgrade
334693	G52351		335833	G52200		339129	G52096		339332	G52382	
334698	G52298		335834	G52199		339140	G52261		339344	G52131	
334699	G52297		335844	G52128		339141	G52260		339345	G52356	
334700	G52006		335845	G52127		339146	G52122		339346	G52355	
334701	G52005		335920	G56791		339147	G52121		339347	G52525	
3348018	G52450		335920	G56792		339148	G55949		339348	G52524	
3348019	G52449		335924	G52145		339149	G52183		339361	G52361	
3348041	G52256		335925	G52144		339150	G52182		339362	G52360	
3348042	G52255		338001	G52153		339155	G52210		339365	G52188	
3348056	G52256		338002	G52152		339156	G52209		339366	G52187	
3348057	G52255		338009	G52153		339169	G52375		339377	G52279	
334812	G56606		338010	G52152		339170	G52374		339378	G52278	
334834	G56899		338011	G56887		339185	G52103		339725	G52006	
334842	G52275		338012	G56886		339188	G52171		339726	G52005	
334843	G52274		338013	G56837		339189	G52170		340018	G51898	
334945	G52238		338014	G56836		339190	G52122		340019	G51815	
334946	G52237		338019	G52163		339191	G52121		340022	G51806	
335030	G56616		338020	G52162		339192	G56722		340024	G51806	
335031	G56615		338022	G52157		339194	G52246		340028	G51856	
335032	G56616		338023	G52156		339195	G52245		340029	G51878	
335032	G56688		338106	G52354		339196	G52174		340030	G51877	
335033	G56615		338107	G52353		339197	G52173		340031	G511003	
335033	G56687		339015	G55948		339198	G52174		340038	G51897	
335035	G56688		339025	G52104		339199	G52173		340039	G51896	
335036	G56687		339026	G52103		339204	G52265		340040	G51878	
335037	G56509		339031	G52007		339205	G52264		340041	G51877	
335040	G56581		339032	G52004		339214	G56721		340043	G63909	
335041	G56582		339037	G52250		339216	G52204		340044	G51892	
335059	G52104		339038	G52249		339217	G52203		340045	G511055	
335060	G52103		339039	G52151		339230	G52202		340046	G511054	
335061	G55948		339040	G52150		339231	G52201		340049	G51919	
335065	G52116		339043	G52104		339234	G52204		340050	G51937	
335070	G52104		339044	G52103		339235	G52203		340056	G51911	
335071	G52103		339053	G52026		339242	G52332		340063	G51738	
335072	G52128		339054	G52027		339243	G52331		340068	G51863	
335073	G52127		339057	G56773		339246	G52131		340069	G51916	
335074	G52128		339058	G56774		339247	G52118		340070	G51975	
335075	G52127		339072	G52141		339248	G52117		340071	G51860	
335082	G52294		339073	G52140		339249	G52149		340072	G51861	
335083	G52293		339080	G52300		339250	G52148		340073	G51864	
335084	G52128		339081	G52299		339251	G52148		340075	G51865	
335085	G52127		339084	G56810		339251	G52149		340084	83515	
335094	G52127		339085	G56810		339252	G52148		340085	G51739	
335095	G52127		339086	G56514		339252	G52149		340090	G51933	
335610	G52399		339087	G56506		339261	G52188		340094	G51863	
335611	G52398		339100	G52108		339262	G52187		340098	G51863	
335623	G52406		339101	G52107		339263	G52254		340115	G51972	
3357504	G52495		339102	G52106		339264	G52253		340121	G51856	
3357505	G52494		339102	G52108		339269	G52143		3410014	G51898	
3358000	G52301		339103	G52105		339270	G52142		3410018	G51842	
335808	G56899		339103	G52107		339272	G52125		3410084	G511038	
335809	G56778		339114	G52246		339309	G52258		341117	G55774	
335810	G56778		339115	G52245		339310	G52257		341118	G55774	
335814	G52301		339124	G52300		339311	G52171		341120	G56591	
335815	G52314		339125	G52299		339312	G52170		341125	G55804	
335816	G52314		339128	G52097		339331	G52383		341141	G55820	

**Important Note:** Competitive Interchanges are to be used for stocking purposes only. Where multiple crosses are identified, please reference the applications section of this catalog. / **Remarque importante:** Les interchanges concurrentiels ne s'utilisent qu'aux fins de stocks. Dans le cas de références multiples, consulter la section des applications du catalogue. / **Nota importante:** Dans le cas de referencias multiples, consultar la sección de aplicaciones del catálogo. / **Nota importante:** Se pueden usar intercambios competitivos para propósitos de almacenamiento solamente. Cuando se identifican intercambios múltiples, consulte la sección de aplicaciones de este catálogo.

**COMPETITIVE & O.E.M. INTERCHANGE LIST**  
**Lista de Intercambios contra Competidores y Equipo Original.**  
**Liste d'interchange de produits compititifs & d'equipement original (OEM)**

**KYB... cont'd**

Kyb	Gabriel	Upgrade	Kyb	Gabriel	Upgrade	Kyb	Gabriel	Upgrade	Kyb	Gabriel	Upgrade
341180	G51855		341458	G51854		341627	85006		343157	69604	
341198	G55910		341459	G51853		341628	85724	89443	343157	81492	
341202	G51087		341466	G51477		341628	89443		343161	69755	
341205	G51742		341467	G51766		341629	85938		343164	69632	
341207	G51097		341468	G51765		341630	85052		343208	G63902	
341217	G51841		341472	G51849		341631	646155		343208	G63909	
341244	G55825		341473	G51849		341632	83124	89407	343209	G63903	
341245	G56565		341474	G56838		341632	89407		343209	G63937	
341253	G56597		341475	G56839		341633	83215		343210	G63799	
341254	G56597		341476	G51806		341654	G51842		343211	69676	
341266	G56598		341480	G51855		341658	70027		343218	69622	
341271	G51727		341481	G51774		341659	70027		343219	81270	
341276	G51767		341483	G51825		341661	G51704		343240	82156	
341280	G51714		341484	G51815		341662	G51703		343247	G63799	
341299	G51740		341485	G51758		341664	G51719		343252	G63907	
341302	G63678		341486	G51961		341665	G51729		343255	69863	
341311	G51700		341489	G51758		341666	G51948		343270	70020	
341322	G51795		341492	G51879		341667	G51947		343272	69813	
341326	G51722		341493	G51870		341668	G51842		343280	69945	
341327	G51724		341493	G51891		341681	G51916		343281	69946	
341331	G51738		341495	G51847		341682	G51975		343284	69946	
341339	G63918		341499	G51848		341683	G51934		343290	69464	
341340	G51739		341600	G51715		341704	G51900		343291	69465	
341341	G51727		341601	G51703		3417504	G511000		343295	69450	
341342	G51794		341601	G51704		3417505	G51721		343308	69587	
341343	G63783		341602	G51703		341814	69586		343313	G63860	
341343	G63893		341603	70013		341842	G51097		343314	G63860	
341344	G51739		341604	G51267		341845	G51740		343330	82125	
341348	G51838		341605	G51719		341907	G51759		343342	G63902	
341361	G51838		341607	G51729		341924	G51881		343348	69945	
341362	G51716		341609	G51761		341952	G64047		343352	69863	
341363	G51898		341609	G51947		341966	G51759		343353	69585	
341364	G52037		341613	85062	89408	3430015	G51905		343353	70001	
341365	G52036		341613	89408		3430019	G51799		343367	G63907	
341366	G51814		341614	85001	89410	3430024	G51799		343379	G63845	
341367	G51813		341614	89410		3430041	70207		343381	70060	
341368	G51794		341615	83215		3430043	G51990		343385	69473	
341369	G51738		341617	85005	89430	3430044	G51766		343388	G63712	
341373	G51883		341617	89430		3430068	70231		343395	G63842	
341374	G51850		341618	85918	89449	343010	69787		343395	G64014	
341374	G63884		341618	89449		343127	69600		343410	G63937	
341382	G51736		341619	83136		343127	69625		343412	70003	
341392	G51832		341620	85033	89427	343127	69675		343413	69464	
341393	G51833		341620	89427		343127	81750		343419	70056	
341402	G51880		341621	85311	89424	343127	82118		343425	G63409	
341405	G51859		341621	89424		343128	69675		343426	70028	
341406	G51859		341622	85023	89415	343128	82110		343429	69464	
341419	G51723		341622	89415		343130	69724		343433	G63872	
341425	G51908		341623	85003	89411	343130	82051		343435	G64052	
341440	G51477		341623	89411		343131	69624		343442	G51783	
341441	G51926		341624	85036	89405	343135	69606		343444	G63907	
341442	G51925		341624	89405		343143	82005		343452	69420	
341443	G51910		341625	85000	89436	343144	82001		343454	69589	
341444	G51908		341625	89436		343147	81340		343458	70041	
341448	G51898		341626	85000	89436	343149	82155		343460	G51807	
341457	G51852		341626	89436		343156	81491		343465	70041	

**Important Note:** Competitive Interchanges are to be used for stocking purposes only. Where multiple crosses are identified, please reference the applications section of this catalog. / **Remarque importante:** Les interchanges concurrentiels ne s'utilisent qu'aux fins de stocks. Dans le cas de rferences multiples, consulter la section des applications du catalogue. / **Nota importante:** Dans le cas de rferences multiples, consulter la section des applications du catalogue. / **Nota importante:** Se pueden usar intercambios competitivos para propósitos de almacenamiento solamente. Cuando se identifican intercambios múltiples, consulte la sección de aplicaciones de este catálogo.

**COMPETITIVE & O.E.M. INTERCHANGE LIST**  
**Lista de Intercambios contra Competidores y Equipo Original.**  
**Liste d'interchange de produits complitifs & d'equipement original (OEM)**

**KYB... cont'd**

Kyb	Gabriel	Upgrade	Kyb	Gabriel	Upgrade	Kyb	Gabriel	Upgrade	Kyb	Gabriel	Upgrade
343471	G51783		344084	G63490		344358	G64087		344428	G63494	
343479	G51716		344085	G63306		344359	G63720		344428	G63510	
343484	G64089		344086	G63353		344363	69591		344429	G63907	
343487	70060		344087	G63377		344364	77980		344430	G63495	
3438002	70052		344088	G63424		344365	G63662		344430	G63611	
3440012	G511044		344089	G63424		344366	G63366		344430	G63909	
3440013	G511078		344089	G63683		344367	G63714		344431	G63620	
3440022	G51965		344090	G63492		344368	G63716		344432	69962	
3440029	77967		344090	G63928		344369	G63624		344433	69898	
3440035	G511030		344091	G63511		344370	G63622		344434	69962	
3440040	G51980		344092	G63490		344371	G63623		344435	G63721	
3440047	G511135		344093	G63905		344372	G63661		344436	G63866	
3440049	G51766		344094	G63915		344373	G63674		344437	G63866	
3440055	G511038		344097	G63907		344373	G63675		344438	G63869	
3440060	G51766		344110	69845		344374	G63778		344439	G51798	
3440067	G64177		344202	G63479		344375	G63715		344447	G63689	
3440072	70213		344202	G63547		344376	G63673		344448	G63689	
344008	G511030		344222	G63782		344377	G63717		344450	G51802	
3440084	G64146		344223	G63781		344378	G63403		344455	G51812	
3440089	G63866		344229	G63708		344378	G63890		344459	G51799	
344015	G63928		344262	G63638		344378	G63891		344464	G63879	
344040	G63421		344262	G63897		344379	G63403		344465	G63884	
344041	G63422		344263	G63488		344380	G63783		344466	G63882	
344042	G63423		344263	G63638		344381	G63803		344467	G63873	
344043	G63813		344264	G63387		344382	G63808		344468	G63909	
344043	G63902		344265	G63489		344383	G63817		344469	G63813	
344043	G63909		344265	G63783		344384	G63866		344475	G63902	
344044	G63492		344266	G63609		344385	G63866		344479	G51803	
344044	G63907		344266	G63818		344386	G63675		344480	G51805	
344045	G63419		344267	G63455		344387	G63692		344481	G63894	
344045	G63492		344268	G63614		344388	G63929		344483	G63896	
344047	G63950		344269	G63679		344396	G63525		344487	70034	
344049	G63414		344272	G63386		344396	G63683		344491	G51812	
344050	G63773		344273	G63638		344396	G63773		344496	G64012	
344054	G63404		344274	G55821		344397	G63772		344500	G64048	
344055	G63299		344279	G63707		344398	G63958		344501	70049	
344055	G63689		344290	G63490		344399	G63848		344609	G51267	
344066	G63359		344291	G63676		344400	G63958		344610	G51268	
344067	G63347		344291	G63873		344400	G64009		344611	G51858	
344068	G63355		344294	G64027		344402	G63783		344612	G51736	
344070	G63353		344295	G64028		344403	G63722		344655	70068	
344071	G63350		344296	70000		344404	G63844		344655	70209	
344072	G63349		344298	G63611		344406	G64087		344658	G64216	
344073	G63413		344299	G63710		344409	G63918		344660	G51721	
344074	G63183		344304	G63375		344410	G63885		344663	70210	
344075	G63413		344305	G63678		344410	G64029		344664	70213	
344076	G63410		344308	G511007		344410	G64030		344807	69586	
344076	G63414		344314	69907		344413	G63810		344808	69586	
344078	G63409		344328	83159		344414	G63870		3450011	G64043	
344078	G63683		344338	G63776		344415	G63867		3450014	G64121	
344079	G63775		344338	G63869		344415	G64157		345005	G63694	
344080	G63426		344341	G63847		344418	G63425		345022	G63832	
344080	G63690		344342	G63829		344419	G63888		345023	G63828	
344081	G63375		344353	69909		344426	G63299		345024	G63864	
344081	G63915		344355	G63707		344427	G63904		345025	83515	
344082	G63454		344356	69900		344427	G63909		345030	G63394	

**Important Note:** Competitive Interchanges are to be used for stocking purposes only. Where multiple crosses are identified, please reference the applications section of this catalog. / **Remarque importante:** Les interchanges concurrentiels ne s'utilisent qu'aux fins de stocks. Dans le cas de références multiples, consulter la section des applications du catalogue. / **Nota importante:** Dans le cas de références multiples, consulter la section des applications du catalogue. / **Nota importante:** Se pueden usar intercambios competitivos para propósitos de almacenamiento solamente. Cuando se identifican intercambios múltiples, consulte la sección de aplicaciones de este catálogo.

**COMPETITIVE & O.E.M. INTERCHANGE LIST**  
**Lista de Intercambios contra Competidores y Equipo Original.**  
**Liste dinterchange de produits comptitifs & dquipement original (OEM)**

**KYB... cont'd**

Kyb	Gabriel	Upgrade	Kyb	Gabriel	Upgrade	Kyb	Gabriel	Upgrade	Kyb	Gabriel	Upgrade
345038	G63615		348060	G511037		349119	83159		444136	G63775	
345039	G63694		348066	G511092		349122	G64046		444203	83515	
345042	G63883		348069	70055		349123	G63958		444209	83114	
345043	G63878		348085	G511092		349124	G63967		444235	G63421	
345055	G63872		349001	G63918		349125	G63776		444236	G63422	
345055	G64140		349004	58944		349125	G64040		444244	G63409	
345056	G64033		349005	G64032		349127	83159		444249	G63489	
345061	77949		349007	70039		349130	G64040		444250	G63488	
345062	G63971		349008	69590		349136	70059		444252	G63638	
345067	G64031		349009	G63897		349136	70204		444254	G63366	
345068	69595		349010	G63889		349139	70089		444255	G63414	
345070	G63888		349010	G64006		349142	G64111		444256	G63455	
345072	G64010		349024	G64026		349146	G63888		444269	83159	
345073	G63866		349024	G64151		349147	G64121		444323	G63907	
345074	G63959		349025	G64080		349151	G64104		444328	83159	
345075	69594		349026	69592		349165	70096		445016	83515	
345080	G63622		349026	69593		349168	G51996		445054	83613	
345084	G63872		349035	70053		349183	G63886		445064	83162	
345601	83613		349039	G64003		349184	70098		445067	85009	
345602	85052		349040	G511004		349185	G63885		446074	85308	89422
345604	85051		349043	69587		349187	G64216		446074	89422	
345605	85012	89413	349044	G64089		349191	G63894		446075	83215	
345605	89413		349045	G64089		349194	G511002		447001	85308	89422
345606	83136		349046	G63895		349194	G511134		447001	89422	
345607	83130		349054	G63815		349199	G511122		5510000	G51860	
345608	85060		349054	G64038		349207	69907		5510001	G51861	
345609	83515		349060	70013		349212	G511044		5510025	G51980	
345611	83120		349065	70086		349217	70203		551091	77678	
345613	85005	89430	349067	G51993		349219	G511078		551093	G51477	
345613	89430		349068	G64037		349225	G64042		551104	G51739	
345614	83309		349069	G63966		349230	G64012		551105	70003	
345615	83314		349069	G63967		349232	G63799		551121	G51891	
345616	83125		349071	G64008		349237	G511043		551125	G51855	
345617	83203	89436	349073	G64042		349240	G511044		551126	G51921	
345617	89436		349075	70089		349243	70068		551127	G51920	
345618	83126	89430	349076	G64056		349244	70068		551130	G51921	
345618	89430		349078	G64050		354055	G64015		551131	G51920	
345620	83456	89447	349080	G64063		366010	G44461		551132	G51922	
345620	89447		349083	G64063		441120	G55698		551133	G51864	
345621	85003	89411	349085	70037		441120	G55825		551134	G51865	
345621	89411		349086	70086		441133	83515		551136	G511142	
345624	G64148		349092	G51884		441600	85310	89423	551139	G51766	
345625	G511000		349093	G51874		441600	89423		551600	G51887	
345626	G511000		349094	G64071		441602	85724	89443	551602	G51888	
345626	G511038		349095	G51966		441602	89443		551605	G51746	
345627	G51928		349097	G64050		443078	G63902		551610	G51773	
346016	G51905		349098	70095		443216	G63495		5530004	G64089	
348002	70036		349101	G64047		443240	G63907		5530008	70089	
348007	70036		349102	70013		443259	G63907		5530013	G51874	
348016	G51905		349105	70010		443363	G63845		553153	77907	
348018	70052		349106	G511001		443477	69632		553158	G63799	
348019	G511092		349108	G64079		443478	69945		553160	77479	
348023	G51807		349109	G51799		444012	G63492		553171	G63495	
348029	G51990		349110	G64043		444024	G63492		553197	69952	
348032	G51971		349115	70078		444058	83159		553198	69966	
348038	69464		349117	G64042		444135	G63678		553209	G63495	

**Important Note:** Competitive Interchanges are to be used for stocking purposes only. Where multiple crosses are identified, please reference the applications section of this catalog./ **Remarque importante:** Les interchanges concurrentiels ne s'utilisent qu'aux fins de stocks. Dans le cas de rfrences multiples, consulter la section des applications du catalogue./ **Nota importante:** Dans le cas de rfrences multiples, consulter la section des applications du catalogue./ **Nota importante:** Se pueden usar intercambios competitivos para propósitos de almacenamiento solamente. Cuando se identifican intercambios múltiples, consulte la sección de aplicaciones de este catálogo.



**COMPETITIVE & O.E.M. INTERCHANGE LIST**  
**Lista de Intercambios contra Competidores y Equipo Original.**  
**Liste dinterchange de produits comptitifs & dquipement original (OEM)**

**KYB... cont'd**

Kyb	Gabriel	Upgrade	Kyb	Gabriel	Upgrade	Kyb	Gabriel	Upgrade	Kyb	Gabriel	Upgrade
553239	69863		554182	G63690		554306	75676		555051	G64031	
553256	83159		554184	77909		554312	77375		555052	69594	
553303	G63845		554185	G63844		554319	77817		555054	77953	
553310	69624		554186	77716		554320	77947		555054	77975	
553311	77971		554187	77715		554321	77954		555055	77976	
553320	69600		554188	77803		554322	77949		555056	77952	
553333	69473		554189	77953		554324	77638		555057	G64033	
553345	G64016		554195	G63867		554327	G63882		555058	77953	
553346	G63892		554198	77953		554328	G51850		555060	69595	
553360	G63937		554199	77950		554329	G63879		555601	69575	
553361	G63689		554200	77829		554330	77909		555603	69574	
553367	70033		554203	G63386		554331	77909		555604	G51904	
553381	70038		554206	77638		554342	G63894		555609	G51871	
553385	70040		554207	77661		554344	77638		555610	G64046	
553387	G63907		554208	77661		554347	77951		564002	G51077	
553389	G51983		554209	77662		554347	77967		565013	G63624	
553392	G511001		554210	G63353		554348	77638		565033	77638	
5540000	77951		554211	G63350		554350	G63889		565060	77375	
5540005	G63918		554216	77662		554353	G64015		565062	77609	
5540007	G64089		554223	77662		554356	G63895		565068	77412	
5540017	G64089		554225	G63676		554359	77949		565090	77809	
5540021	G511043		554228	77661		554360	77950		565091	77809	
5540022	77976		554229	77717		554362	77968		565101	77783	
554003	G63610		554230	77717		554362	77969		634812	G56606	
554041	G56802		554231	77978		554364	77981		734033	G56606	
554044	77726		554233	77783		554365	77973		743029	69945	
554060	G63455		554234	77803		554367	G64038		KG4026	G63492	
554069	77479		554235	77678		554369	77807		KG4159	G63892	
554075	77907		554236	77614		554370	77623		KG4160	G64016	
554100	G63495		554237	G63950		554372	G64063		KG4162	77971	
554101	77907		554238	77614		554373	G64079		KG4163	G63845	
554125	G63707		554239	77607		554374	G64043		KG4503	82026	
554127	G63708		554240	77808		554375	G64043		KG4503	82069	
554128	77726		554241	77808		554376	G63966		KG4507	82011	
554131	G63494		554242	77815		554377	G64012		KG4515	69675	
554132	G63928		554243	77815		554378	G64040		KG4515	82110	
554152	G63776		554244	G63611		554379	G64042		KG4530	69996	
554153	77489		554245	G63710		554380	83159		KG4537	69714	
554154	77638		554246	77783		554382	G64089		KG4539	69725	
554156	77915		554247	77817		554383	83159		KG4540	69677	
554158	G63890		554248	77953		554384	70098		KG4613A	G63909	
554159	77915		554249	77412		554385	70095		KG4731	70065	
554160	77905		554252	G63404		554385	70102		KG4738	G63860	
554161	77375		554255	77909		554385	70208		KG4740	70064	
554162	G63624		554257	77907		554386	G63862		KG4742	69952	
554163	77609		554260	77414		554388	77952		KG4743	69966	
554165	G51724		554262	77454		554389	G64121		KG4745A	G63799	
554166	77716		554264	G63511		554390	G64043		KG4752	G63937	
554168	77461		554265	G63490		554398	G63873		KG5039	G63844	
554169	G63424		554268	77909		554402	G511002		KG5040	77803	
554170	77525		554270	77412		5550006	77976		KG5041	77953	
554173	77907		554274	77614		555023	G63878		KG5045	G63868	
554174	G63299		554277	G63623		555024	G63883		KG5194	G64000	
554177	77614		554280	69604		555038	77614		KG5196	77950	
554178	77608		554281	69600		555039	77623		KG5197	77829	
554180	77422		554292	69624		555050	77983		KG5401	G63299	

**Important Note:** Competitive Interchanges are to be used for stocking purposes only. Where multiple crosses are identified, please reference the applications section of this catalog. / **Remarque importante:** Les interchanges concurrentiels ne s'utilisent qu'aux fins de stocks. Dans le cas de références multiples, consulter la section des applications du catalogue. / **Nota importante:** Dans le cas de referencias multiples, consultar la sección de aplicaciones del catálogo. / **Nota importante:** Se pueden usar intercambios competitivos para propósitos de almacenamiento solamente. Cuando se identifican intercambios múltiples, consulte la sección de aplicaciones de este catálogo.

**COMPETITIVE & O.E.M. INTERCHANGE LIST**  
**Lista de Intercambios contra Competidores y Equipo Original.**  
**Liste dinterchange de produits comptitifs & dquipement original (OEM)**

**KYB... cont'd**

Kyb	Gabriel	Upgrade	Kyb	Gabriel	Upgrade	Kyb	Gabriel	Upgrade	Kyb	Gabriel	Upgrade
KG5404	G63360		KG5446	G63813		KG5747	69901		SM5126	142561	
KG5406	G63386		KG5446	G63909		KG5780	G63894		SM5137	143320	
KG54100	77638		KG5451	77422		KG5784	77947		SM5138	142843	
KG54101	77638		KG5452	77423		KG5785	77954		SM5140	142402	
KG54102	77661		KG5455	G63456		KG5786	77949		SM5151	143458	
KG54103	77674		KG5457	G63690		KG5787A	69757		SM5162	143367	
KG54103	77948		KG5458	77375		KG6002A	85030	89440	SM5165	143191	
KG54103	77980		KG5458	77915		KG6002A	89440		SM5168	142828	
KG54104	77662		KG5459	77454		KG6003	83309		SM5169	142930	
KG5420	G63366		KG5462	77494		KG6004	85320	89429	SM5174	142836	
KG5421	G63387		KG5465	77425		KG6004	89429		SM5178	143197	
KG5422	G63183		KG5466	G63492		KG6005	83216		SM5179	142649	
KG54300	G63615		KG5474	77479		KG6006	85012	89413	SM5180	142650	
KG54301	G63616		KG5475	77726		KG6006	89413		SM5181	142651	
KG54302	G63782		KG5475	G63432		KG6007	85007		SM5184	143325	
KG54303	G63781		KG5476	77909		KG6008A	83122	89406	SM5193	142625	
KG54304	G63707		KG5478	77489		KG6008A	89406		SM5197	142444	
KG54306	77675		KG5479	77488		KG6009A	83303		SM5198	143256	
KG54308	G63708		KG5480	77609		KG6010	83308		SM5199	142932	
KG54309	77678		KG5481	G63411		KG6198	G63616		SM5203	142938	
KG5431	G63511		KG5482	77412		KG6199	85012	89413	SM5211	143315	
KG54310	G63676		KG5484	G63635		KG6199	89413		SM5213	143209	
KG54311	77714		KG5487	77525		KG6201	83456	89447	SM5215	143201	
KG54313	77716		KG5487	77683		KG6201	89447		SM5237	142653	
KG54314	77715		KG5487	G63525		KG6403	G63605		SM5244	143465	
KG54315	77673		KG5488	G63403		KG6406	G63183		SM5245	143466	
KG54317	G63726		KG5489	77614		KG6407	G63394		SM5260	143082	
KG54319	G64002		KG5489	G63614		KG6412	G63625		SM5264	143423	
KG54320	77455		KG5490	77679		KG6413	77614		SM5265	142932	
KG54320	77717		KG5491	G63604		KG6413	G63622		SM5285	143459	
KG54321	77403		KG5493	77461		KG6414	77623		SM5295	143087	
KG54322	77403		KG5493	77524		KG6415	85013	89414	SM5300	142852	
KG54323	77978		KG5494	G63620		KG6415	89414		SM5314	143464	
KG54325	G63776		KG5495	77608		KG6416	83123	89405	SM5324	142546	
KG54326	77783		KG5495	G63929		KG6416	89405		SM5329	142938	
KG54327	77803		KG5496	G63624		KG9025	G51077		SM5361	143492	
KG54328	77772		KG5497	77807		KG9026	G51477		SM5366	143204	
KG54329	77607		KG5497	G63622		SB101	143057		SM5378	142444	
KG54330	77809		KG5498	77623		SB103	143058		SM5379	143380	
KG54330	G63809		KG5498	G63623		SB104	143059		SM5382	143094	
KG54331	77837		KG5507	69724		SB107	143063		SM5385	142561	
KG54331	G63837		KG5507	82051		SB132	143064		SM5388	143087	
KG54332	77808		KG5522	69606		SM5013	142135		SM5392	143357	
KG54333	77810		KG5534	G63610		SM5034	142195		SM5398	143073	
KG54333	G63810		KG5538	77494		SM5041	142852		SM5399	143074	
KG54335	77815		KG5554	69766		SM5049	143281		SM5402	143353	
KG54336	77815		KG5562	75676		SM5057	142530		SM5403	143353	
KG54339	77783		KG5564	69715		SM5058	142230		SM5409	142937	
KG54340	77817		KG5570	69811		SM5070	142252		SM5423	143202	
KG54341	77662		KG5571	69795		SM5079	142245		SM5424	143244	
KG54342	77412		KG5572	77375		SM5091	142419		SM5425	143244	
KG5438	77907		KG5575	69962		SM5091	143394		SM5441	143398	
KG5440	77414		KG5603A	G63418		SM5091	143422		SM5442	143325	
KG5440	77905		KG5614	77909		SM5109	142329		SM5443	143404	
KG5440	G63350		KG5615	77909		SM5122	142546		SM5444	143405	
KG5444	G63904		KG5744	77847		SM5123	142547		SM5447	143354	

**Important Note:** Competitive Interchanges are to be used for stocking purposes only. Where multiple crosses are identified, please reference the applications section of this catalog./ **Remarque importante:** Les interchanges concurrentiels ne s'utilisent qu'aux fins de stocks. Dans le cas de rfrences multiples, consulter la section des applications du catalogue./ **Nota importante:** Dans le cas de rfrences multiples, consulter la section des applications du catalogue./ **Nota importante:** Se pueden usar intercambios competitivos para propósitos de almacenamiento solamente. Cuando se identifican intercambios múltiples, consulte la sección de aplicaciones de este catálogo.

**COMPETITIVE & O.E.M. INTERCHANGE LIST**  
**Lista de Intercambios contra Competidores y Equipo Original.**  
**Liste d'interchange de produits compétitifs & d'équipement original (OEM)**

**KYB... cont'd**

Kyb	Gabriel	Upgrade	Kyb	Gabriel	Upgrade	Kyb	Gabriel	Upgrade	Kyb	Gabriel	Upgrade
SM5451	143239		SM5776	143416		SR4082	G57019		SR4143	G57077	
SM5459	143218		SR1002	49228		SR4085	G57079		SR4144	G57664	
SM5460	142419		SR4001	G56927		SR4086	G57078		SR4145	G57663	
SM5461	143088		SR4002	G57060		SR4087	G57072		SR4146	G57106	
SM5471	143355		SR4009	G56937		SR4088	G57071		SR4147	G57105	
SM5472	143194		SR4010	G56934		SR4089	G57060		SR4148	G57212	
SM5475	143191		SR4011	G56936		SR4090	G57051		SR4149	G57015	
SM5476	143425		SR4016	G56935		SR4092	G56925		SR4150	G57042	
SM5483	143089		SR4023	G57118		SR4093	G56924		SR4151	G57041	
SM5489	143418		SR4024	G56951		SR4094	G57070		SR4152	G57350	
SM5491	143388		SR4025	G56938		SR4095	G57069		SR4153	G57349	
SM5492	143387		SR4027	G57064		SR4096	G57077		SR4154	G57666	
SM5513	143323		SR4028	G57063		SR4097	G57076		SR4155	G57665	
SM5517	143419		SR4029	G56931		SR4098	G57122		SR4156	G57035	
SM5530	143316		SR4030	G56930		SR4099	G57122		SR4157	G57034	
SM5531	143324		SR4033	G56934		SR4100	G57046		SR4158	G57016	
SM5533	143335		SR4033	G56937		SR4101	G57045		SR4159	G57111	
SM5535	143369		SR4034	G56936		SR4102	G57142		SR4159	G57536	
SM5535	143468		SR4035	G56933		SR4105	G57046		SR4160	G57110	
SM5537	143305		SR4036	G56932		SR4106	G57045		SR4160	G57535	
SM5539	143416		SR4037	G56928		SR4107	G57026		SR4161	G57198	
SM5542	143455		SR4038	G56957		SR4108	G57191		SR4162	G57197	
SM5567	143344		SR4039	G56956		SR4109	G57190		SR4163	G57031	
SM5568	142526		SR4040	G56997		SR4110	G57191		SR4164	G57030	
SM5569	143319		SR4041	G56996		SR4111	G57190		SR4165	G57053	
SM5581	143564		SR4042	G56998		SR4112	G57193		SR4166	G57053	
SM5582	143462		SR4051	G57018		SR4113	G57192		SR4167	G57271	
SM5583	143461		SR4052	G57039		SR4115	G57081		SR4168	G57120	
SM5589	143191		SR4053	G56965		SR4116	49255		SR4169	G57119	
SM5589	143365		SR4054	G57042		SR4117	G57358		SR4170	G57120	
SM5597	143408		SR4055	G57041		SR4118	G57357		SR4171	G57103	
SM5601	143495		SR4056	G57048		SR4119	G57134		SR4172	G57132	
SM5602	143318		SR4057	G57047		SR4120	G57133		SR4173	G57419	
SM5603	143391		SR4058	G57044		SR4121	G57055		SR4174	G57419	
SM5604	143390		SR4059	G57043		SR4122	G57054		SR4175	G57206	
SM5607	142930		SR4060	G56963		SR4123	G57354		SR4176	G57206	
SM5608	143363		SR4061	G56962		SR4124	G57353		SR4177	G57373	
SM5610	143460		SR4064	G56948		SR4125	G57397		SR4178	G57372	
SM5618	143342		SR4065	G56948		SR4126	G57203		SR4179	G57085	
SM5619	143531		SR4066	G56950		SR4127	G57202		SR4180	G57084	
SM5620	143412		SR4067	G56949		SR4128	G57050		SR4181	G57085	
SM5638	143406		SR4068	G57115		SR4129	G57049		SR4182	G57084	
SM5644	143345		SR4069	G57114		SR4129	G57050		SR4183	G57330	
SM5653	143366		SR4070	G56964		SR4130	G57134		SR4184	G57329	
SM5659	142653		SR4071	G57012		SR4131	G57133		SR4185	G57164	
SM5660	143491		SR4072	G57011		SR4132	G57056		SR4186	G57163	
SM5661	143397		SR4073	G57022		SR4133	G57134		SR4187	G57208	
SM5668	143477		SR4074	G56992		SR4134	G57133		SR4188	G57207	
SM5677	143336		SR4075	G56991		SR4135	G57055		SR4189	G57418	
SM5682	143369		SR4076	G56943		SR4136	G57054		SR4190	G57417	
SM5683	143369		SR4077	G57020		SR4137	G57095		SR4191	G57087	
SM5688	143305		SR4078	G57021		SR4138	G57191		SR4192	G57086	
SM5721	143349		SR4079	G57000		SR4139	G57190		SR4193	G57087	
SM5729	143473		SR4079	G57023		SR4140	G57080		SR4194	G57086	
SM5737	143339		SR4079	G57125		SR4141	G57096		SR4195	G57206	
SM5756	143415		SR4081	G57017		SR4142	G57076		SR4196	G57206	

**Important Note:** Competitive Interchanges are to be used for stocking purposes only. Where multiple crosses are identified, please reference the applications section of this catalog. / **Remarque importante:** Les interchanges concurrentiels ne s'utilisent qu'aux fins de stocks. Dans le cas de références multiples, consulter la section des applications du catalogue. / **Nota importante:** Dans le cas de références multiples, consulter la section des applications du catalogue. / **Nota importante:** Se pueden usar intercambios competitivos para propósitos de almacenamiento solamente. Cuando se identifican intercambios múltiples, consulte la sección de aplicaciones de este catálogo.

**COMPETITIVE & O.E.M. INTERCHANGE LIST**  
**Lista de Intercambios contra Competidores y Equipo Original.**  
**Liste dinterchange de produits comptitifs & dquipement original (OEM)**

**KYB... cont'd**

Kyb	Gabriel	Upgrade	Kyb	Gabriel	Upgrade	Kyb	Gabriel	Upgrade	Kyb	Gabriel	Upgrade
SR4199	G57008		SR4279	G57282		SR4453	G57562		SR4529	G57133	
SR4200	G57007		SR4317	G57378		SR4453	G57790		SR4532	G57709	
SR4201	G57646		SR4318	G57377		SR4454	G57484		SR4535	G57794	
SR4202	G57647		SR4388	G57480		SR4455	G57483		SR4536	G57794	
SR4203	G57413		SR4389	G57479		SR4459	G57205		SR4545	G57023	
SR4206	G57109		SR4404	G57540		SR4460	G57204		SR4546	G57023	
SR4206	G57314		SR4405	G57539		SR4461	G57205		SR4547	G57000	
SR4207	G57330		SR4408	G57567		SR4462	G57204		SR4548	G57147	
SR4208	G57329		SR4409	G57566		SR4463	G57133		SR4553	G57779	
SR4211	G57324		SR4415	G57731		SR4464	G57134		SR4554	G57778	
SR4214	G57201		SR4415	G57733		SR4465	G57221		SR4555	G57466	
SR4215	G57200		SR4416	G57730		SR4466	G57220		SR4556	G57465	
SR4216	G57177		SR4416	G57732		SR4469	G57799		SR4558	G57456	
SR4217	G57176		SR4417	G57785		SR4470	G57786		SR4559	G57455	
SR4218	G57178		SR4418	G57784		SR4471	G57786		SR4576	G57191	
SR4219	G57219		SR4419	G57725		SR4472	G57124		SR4577	G57190	
SR4220	G57218		SR4420	G57724		SR4473	G57123		SR4580	G57370	
SR4222	G57343		SR4423	G57415		SR4478	G57544		SR4581	G57369	
SR4223	G57344		SR4424	G57404		SR4479	G57543		SR4582	G57429	
SR4223	G57405		SR4424	G57414		SR4480	G57546		SR4583	G57428	
SR4224	G57404		SR4425	G57735		SR4481	G57545		SR4589	G57453	
SR4225	G57162		SR4426	G57734		SR4482	G57629		SR4590	G57454	
SR4226	G57161		SR4427	G57083		SR4483	G57628		SR4591	G57346	
SR4227	G57092		SR4428	G57083		SR4484	G57706		SR4592	G57345	
SR4228	G57334		SR4429	G57083		SR4485	G57705		SR4593	G57423	
SR4229	G57333		SR4430	G57604		SR4486	G57704		SR4594	G57472	
SR4230	G57092		SR4431	G57603		SR4491	G57340		SR4595	G57471	
SR4231	G57696		SR4432	G57598		SR4492	G57339		SR4603	G57223	
SR4232	G57695		SR4433	G57597		SR4498	G57565		SR4604	G57222	
SR4233	G57332		SR4434	G57323		SR4499	G57564		SR4605	G57425	
SR4234	G57331		SR4435	G57322		SR4500	G57276		SR4606	G57424	
SR4235	G57082		SR4436	G57474		SR4501	G57275		SR4607	G57723	
SR4236	G57081		SR4437	G57473		SR4502	G57149		SR4608	G57722	
SR4241	G57391		SR4438	G57172		SR4504	G57447		SR7099	G57121	
SR4242	G57390		SR4439	G57677		SR4504	G57579		SR8069	G57114	
SR4243	G57682		SR4440	G57676		SR4505	G57793		SS10202	14072	
SR4244	G57416		SR4443	G57683		SR4506	G57792		SS10309	6854SE	
SR4245	G57739		SR4444	G57185		SR4515	G57173		SS10317	14040	
SR4246	G57738		SR4445	G57184		SR4516	G57794		SS10317	14071	
SR4261	G57500		SR4446	G57659		SR4517	G57794		SS10318	6853SE	
SR4262	G57499		SR4447	G57658		SR4522	G57138		SS10322	6856SE	
SR4267	G57713		SR4448	G57484		SR4523	G57137		SS10323	6847SE	
SR4268	G57712		SR4449	G57483		SR4524	G57138		SS10325	14017	
SR4271	G57148		SR4450	G57482		SR4525	G57137		SS10325	6804SE	
SR4272	G57148		SR4451	G57481		SR4526	G57781		SS11318	14074	
SR4275	G57394		SR4452	G57563		SR4527	G57780		SS15345	6802SE	
SR4276	G57393		SR4452	G57791		SR4528	G57134		SS15489	6855SE	

**Leyland Truck**

Leyland truck	Gabriel	Upgrade	Leyland truck	Gabriel	Upgrade	Leyland truck	Gabriel	Upgrade	Leyland truck	Gabriel	Upgrade
1456033	85311	89424	1456033	89424							

**LGE Coachworks**

Lge coachworks	Gabriel	Upgrade	Lge coachworks	Gabriel	Upgrade	Lge coachworks	Gabriel	Upgrade	Lge coachworks	Gabriel	Upgrade
ASH-1136	G63623		ASH-1154	G63622							

**Link Manufacturing LTD.**

Link manufacturing ltd.	Gabriel	Upgrade	Link manufacturing ltd.	Gabriel	Upgrade	Link manufacturing ltd.	Gabriel	Upgrade	Link manufacturing ltd.	Gabriel	Upgrade
1201-0012	83023		1201-0154	83051		1201-0254	83051		1201-1043	83025	

**Important Note:** Competitive Interchanges are to be used for stocking purposes only. Where multiple crosses are identified, please reference the applications section of this catalog. / **Remarque importante:** Les interchanges concurrentiels ne s'utilisent qu'aux fins de stocks. Dans le cas de rfrences multiples, consulter la section des applications du catalogue. / **Nota importante:** Dans le cas de rfrences multiples, consulter la section des applications du catalogue. / **Nota importante:** Se pueden usar intercambios competitivos para propósitos de almacenamiento solamente. Cuando se identifican intercambios múltiples, consulte la sección de aplicaciones de este catálogo.

**COMPETITIVE & O.E.M. INTERCHANGE LIST**  
**Lista de Intercambios contra Competidores y Equipo Original.**  
**Liste d'interchange de produits complitifs & d'equipement original (OEM)**

**Link Manufacturing LTD.... cont'd**

Link manufacturing ltd.	Gabriel	Upgrade	Link manufacturing ltd.	Gabriel	Upgrade	Link manufacturing ltd.	Gabriel	Upgrade	Link manufacturing ltd.	Gabriel	Upgrade
1201-1044	83025		12019013	83062		12021042	83025		632129	83023	
1201-1046	83049		12019014	83062		12021043	83025		632155	646177	
1201-1049	83025		12019018	83062		12021044	83025		635705	83016	
1201-1212	83013		12019021	83062		12021046	83049		646168	646155	
1201-1213	83005		1202-0012	83023		12021064	83024		654669	83021	
1201-9007	83054		1202-0032	83016		12021065	83002		654799	83025	
1201-9008	83054		1202-0042	83025		12021164	83031		654811	83024	
1201-9009	83054		1202-0043	83025		12021212	83013		654833	83021	
1201-9010	83053		1202-0044	83025		12021213	83005		654847	83002	
1201-9011	83053		1202-0052	83021		12021286	83056		654849	83031	
1201-9013	83062		1202-0054	83021		1202K065	83002		654867	83025	
1201-9014	83062		1202-1042	83025		1202K164	83031		671093	85043	
1201-9018	83062		1202-1043	83025		1202K264	83031		700115	85712	
1201-9021	83062		1202-1044	83025		1202K286	83056		LG40450	83016	
12010012	83023		1202-1046	83049		1210-0001	646155		LG40470	83016	
12010154	83051		1202-1064	83024		1210-0002	632147		R71-1004	83049	
12010254	83051		1202-1065	83002		1210-0005	85734		R71-1005	83024	
12011043	83025		1202-1164	83031		1210-0007	665937		R711004	83049	
12011044	83025		1202-1212	83013		1210-0009	665937		R711005	83024	
12011046	83049		1202-1213	83005		1210-0010	646155		T71-1000	83031	
12011049	83025		1202-1286	83056		1210-0012	646155		T71-1001	83031	
12011212	83013		12020012	83023		1210-0528	85043		T71-1002	83002	
12011213	83005		12020032	83016		12100005	85734		T711000	83031	
12019007	83054		12020042	83025		12100528	85043		T711001	83031	
12019008	83054		12020043	83025		14QK-3100	85739		T711002	83002	
12019009	83054		12020044	83025		14QK3100	85739				
12019010	83053		12020052	83021		446-51-211	85739				
12019011	83053		12020054	83021		44651211	85739				

**Lion Bus**

Lion bus	Gabriel	Upgrade	Lion bus	Gabriel	Upgrade	Lion bus	Gabriel	Upgrade	Lion bus	Gabriel	Upgrade
58913-009	85959		60665-025	89405		60665025L	85036	89405	60670-030L	83166	
58913-009L	85959		60665-025L	85036	89405	60665025L	89405		60670018	83166	
58913009	85959		60665-025L	89405		60670-018	83166		60670018L	83166	
58913009L	85959		60665025	85036	89405	60670-018L	83166		60670030	83166	
60665-025	85036	89405	60665025	89405		60670-030	83166		60670030L	83166	

**Lodal Inc.**

Lodal inc.	Gabriel	Upgrade	Lodal inc.	Gabriel	Upgrade	Lodal inc.	Gabriel	Upgrade	Lodal inc.	Gabriel	Upgrade
9960257	83122	89406	9960257	89406							

**London Mixer**

London mixer	Gabriel	Upgrade	London mixer	Gabriel	Upgrade	London mixer	Gabriel	Upgrade	London mixer	Gabriel	Upgrade
MB-37737-30	646155										

**Mack**

Mack	Gabriel	Upgrade	Mack	Gabriel	Upgrade	Mack	Gabriel	Upgrade	Mack	Gabriel	Upgrade
1201-0012	83023		141700005839	85061	89450	14QK-2100	83221		14QK-2102	85304	
12010012	83023		14QK-1200P4	83207	89407	14QK-2100P1	83221		14QK-2105	83209	89414
1202-0012	83023		14QK-1200P4	89407		14QK-2100P2	83209	89414	14QK-2105	89414	
1202-0032	83016		14QK-140	85304		14QK-2100P2	89414		14QK-2107	83209	89414
12020012	83023		14QK-140P1	83225		14QK-2100P3	83207	89407	14QK-2107	83215	
12020032	83016		14QK-142	85305		14QK-2100P3	89407		14QK-2107	89414	
1252607B000	85702		14QK-142AP1	83215		14QK-2100P4	83207	89407	14QK-2107P1	83215	
14-2136M	85061	89450	14QK-142P1	83215		14QK-2100P4	89407		14QK-2107P2	83215	
14-2136M	89450		14QK-143	83207	89407	14QK-2100P5	83221		14QK-2107P3	83215	
141700000370	85061	89450	14QK-143	89407		14QK-2100P6	85036	89405	14QK-2108	83203	89436
141700000370	89450		14QK-145	85307		14QK-2100P6	89405		14QK-2108	89436	
141700000373	85061	89450	14QK-20001P2	85308	89422	14QK-2100P7	83221		14QK-2108P1	83203	89436
141700000380	85061	89450	14QK-20001P2	89422		14QK-2100P8	83242		14QK-2108P1	89436	

**Important Note:** Competitive Interchanges are to be used for stocking purposes only. Where multiple crosses are identified, please reference the applications section of this catalog. / **Remarque importante:** Les interchanges concurrentiels ne s'utilisent qu'aux fins de stocks. Dans le cas de rferences multiples, consulter la section des applications du catalogue. / **Nota importante:** Dans le cas de rferences multiples, consulter la section des applications du catalogue. / **Nota importante:** Se pueden usar intercambios competitivos para propósitos de almacenamiento solamente. Cuando se identifican intercambios múltiples, consulte la sección de aplicaciones de este catálogo.

**COMPETITIVE & O.E.M. INTERCHANGE LIST**  
**Lista de Intercambios contra Competidores y Equipo Original.**  
**Liste d'interchange de produits compititifs & d'equipement original (OEM)**

**Mack... cont'd**

Mack	Gabriel	Upgrade	Mack	Gabriel	Upgrade	Mack	Gabriel	Upgrade	Mack	Gabriel	Upgrade
14QK-2110	85305		14QK-372M2	83209	89414	14QK-414M2	85909		14QK2110	85305	
14QK-2110P1	85305		14QK-372M2	89414		14QK-415M	83112		14QK2110P1	85305	
14QK-2111	83019		14QK-372M3	83122	89406	14QK-415M7	83112		14QK2111	83019	
14QK-2111-P2	83019		14QK-372M3	89406		14QK-421M	85014		14QK2111P2	83019	
14QK-2111-P4	83019		14QK-373	83215		14QK-422M	85933	89454	14QK2111P4	83019	
14QK-2113	85001	89410	14QK-374	83003		14QK-422M	89454		14QK2113	85001	89410
14QK-2113	89410		14QK-375M	83123	89405	14QK-423M	85978		14QK2113	89410	
14QK-2113P3	85001	89410	14QK-375M	89405		14QK-424M	83147		14QK2113P3	85001	89410
14QK-2113P3	89410		14QK-376	83003		14QK-427M	85080		14QK2113P3	89410	
14QK-2113P4	85007		14QK-377M	83215		14QK-428	85080		14QK2113P4	85007	
14QK-2113P5	85001	89410	14QK-378	83215		14QK-428M	85080		14QK2113P5	85001	89410
14QK-2113P5	89410		14QK-378M	83215		14QK-429M2	85072		14QK2113P5	89410	
14QK-2113P6	85007		14QK-382	83018		14QK-431M	85061	89450	14QK2113P6	85007	
14QK-2115	85305		14QK-382-P2	83018		14QK-432M	83050		14QK2115	85305	
14QK-2133M	85001	89410	14QK-390	83105		14QK-434M	85014		14QK2133M	85001	89410
14QK-2133M	89410		14QK-391AM	83041		14QK-439M	83050		14QK2133M	89410	
14QK-2133M2	85001	89410	14QK-391AM2	83041		14QK-493M	83101		14QK2133M2	85001	89410
14QK-2133M2	89410		14QK-391BM	83041		14QK-5142	83142		14QK2133M2	89410	
14QK-2136M	85061	89450	14QK-391BM2	83041		14QK1200P4	83207	89407	14QK2136M	85061	89450
14QK-282P1	83216		14QK-391M	83041		14QK1200P4	89407		14QK282P1	83216	
14QK-282P3	83216		14QK-391M2	83041		14QK140	85304		14QK282P3	83216	
14QK-288-P1	85007		14QK-392AM	85005	89430	14QK140P1	83225		14QK288P1	85007	
14QK-29001P2	85303	89422	14QK-392AM	89430		14QK142	85305		14QK29001P2	85303	89422
14QK-29001P2	89422		14QK-392AM2	85005	89430	14QK142AP1	83215		14QK29001P2	89422	
14QK-29301P1	83207	89407	14QK-392AM2	89430		14QK142P1	83215		14QK29301P1	83207	89407
14QK-29301P1	89407		14QK-392AM3	85005	89430	14QK143	83207	89407	14QK29301P1	89407	
14QK-29301P2	83207	89407	14QK-392AM3	89430		14QK143	89407		14QK29301P2	83207	89407
14QK-29301P2	89407		14QK-392BM	85005	89430	14QK145	85307		14QK29301P2	89407	
14QK-29302	83207	89407	14QK-392BM	89430		14QK20001P2	85308	89422	14QK29302	83207	89407
14QK-29302	89407		14QK-392BM2	85321		14QK20001P2	89422		14QK29302	89407	
14QK-29302P1	83207	89407	14QK-392BM3	85005	89430	14QK2100	83221		14QK29302P1	83207	89407
14QK-29302P1	89407		14QK-392BM3	89430		14QK2100P1	83221		14QK29302P1	89407	
14QK-303M	83050		14QK-392M	85005	89430	14QK2100P2	83209	89414	14QK303M	83050	
14QK-3100	85739		14QK-392M	89430		14QK2100P2	89414		14QK3100	85739	
14QK-3101M	85066	89448	14QK-393AM	83123	89405	14QK2100P3	83207	89407	14QK3101M	85066	89448
14QK-3101M	89448		14QK-393AM	89405		14QK2100P3	89407		14QK3101M	89448	
14QK-3103M	83050		14QK-393M	85010		14QK2100P4	83207	89407	14QK3103M	83050	
14QK-3107M	85061	89450	14QK-396	85005	89430	14QK2100P4	89407		14QK3107M	85061	89450
14QK-3108	85080		14QK-396	89430		14QK2100P5	83221		14QK3108	85080	
14QK-3108M	85080		14QK-396M	85005	89430	14QK2100P6	85036	89405	14QK3108M	85080	
14QK-3114M	85061	89450	14QK-396M	89430		14QK2100P6	89405		14QK3114M	85061	89450
14QK-3115M	85972		14QK-399M	83045		14QK2100P7	83221		14QK3115M	85972	
14QK-3116M	83101		14QK-399M2	83045		14QK2100P8	83242		14QK3116M	83101	
14QK-322M	85933	89454	14QK-399M3	83045		14QK2102	85304		14QK322M	85933	89454
14QK-322M	89454		14QK-410M	83125		14QK2105	83209	89414	14QK322M	89454	
14QK-366	85036	89405	14QK-410M2	83137		14QK2105	89414		14QK366	85036	89405
14QK-366	89405		14QK-410M3	83125		14QK2107	83209	89414	14QK366	89405	
14QK-366P1	85036	89405	14QK-411	83007		14QK2107	83215		14QK366P1	85036	89405
14QK-366P1	89405		14QK-411AM	83007		14QK2107	89414		14QK366P1	89405	
14QK-366P2	85036	89405	14QK-411M	83007		14QK2107P1	83215		14QK366P2	85036	89405
14QK-366P2	89405		14QK-413M	83111		14QK2107P2	83215		14QK366P2	89405	
14QK-366P3	85036	89405	14QK-413M4	83110		14QK2107P3	83215		14QK366P3	85036	89405
14QK-366P3	89405		14QK-413M6	83111		14QK2108	83203	89436	14QK366P3	89405	
14QK-366P4	83209	89414	14QK-413M7	83111		14QK2108	89436		14QK366P4	83209	89414
14QK-366P4	89414		14QK-414M	85906	89407	14QK2108P1	83203	89436	14QK366P4	89414	
14QK-372M	83221		14QK-414M	89407		14QK2108P1	89436		14QK372M	83221	

**Important Note:** Competitive Interchanges are to be used for stocking purposes only. Where multiple crosses are identified, please reference the applications section of this catalog. / **Remarque importante:** Les interchanges concurrentiels ne s'utilisent qu'aux fins de stocks. Dans le cas de références multiples, consulter la section des applications du catalogue. / **Nota importante:** Dans le cas de références multiples, consulter la section des applications du catalogue. / **Nota importante:** Se pueden usar intercambios competitivos para propósitos de almacenamiento solamente. Cuando se identifican intercambios múltiples, consulte la sección de aplicaciones de este catálogo.

**COMPETITIVE & O.E.M. INTERCHANGE LIST**  
**Lista de Intercambios contra Competidores y Equipo Original.**  
**Liste dinterchange de produits comptitifs & dquipement original (OEM)**

**Mack... cont'd**

Mack	Gabriel	Upgrade	Mack	Gabriel	Upgrade	Mack	Gabriel	Upgrade	Mack	Gabriel	Upgrade
14QK372M2	83209	89414	14QK414M2	85909		23159762	85188		471700000431	85066	89448
14QK372M2	89414		14QK415M	83112		23292027	85061	89450	471700000431	89448	
14QK372M3	83122	89406	14QK415M7	83112		23292028	85061	89450	471700000445	85080	
14QK372M3	89406		14QK421M	85014		23327756	83910		471700000451	85080	
14QK373	83215		14QK422M	85933	89454	23359394	83101		471700002626	85061	89450
14QK374	83003		14QK422M	89454		23818296	85978		471700002630	85061	89450
14QK375M	83123	89405	14QK423M	85978		24145343	85005	89430	471700002630	89450	
14QK375M	89405		14QK424M	83147		24145343	89430		471700002861	85014	
14QK376	83003		14QK427M	85080		25621571	83215		471700006039	85088	
14QK377M	83215		14QK428	85080		25621955	85001	89410	471700008934	85065	
14QK378	83215		14QK428M	85080		25621955	89410		471700009646	85088	
14QK378M	83215		14QK431M	85061	89450	25622221	83111		471700009647	85088	
14QK382	83018		14QK432M	83050		25622345	83242		471700009650	85088	
14QK382P2	83018		14QK434M	85014		25622466	85001	89410	471700015341	83127	
14QK390	83105		14QK439M	83050		25622466	89410		471700131921	85933	89454
14QK391AM	83041		14QK493M	83101		25622612	83041		471700131921	89454	
14QK391AM2	83041		14QK5142	83142		25622613	83041		47902-25	83125	
14QK391BM	83041		20469001	85933	89454	25623321	83215		47902-9	83123	89405
14QK391BM2	83041		20469001	89454		25624241	83112		47902-9	89405	
14QK391M	83041		20469002	85933	89454	25624341	83110		4790225	83125	
14QK391M2	83041		20469002	89454		25624351	85909		479029	83123	89405
14QK392AM	85005	89430	20485632	85933	89454	25624837	83041		479029	89405	
14QK392AM	89430		20485632	89454		25624862	85321		4940654	83216	
14QK392AM2	85005	89430	20485633	85933	89454	25625091	83215		5533699	85302	89420
14QK392AM2	89430		20485633	89454		25625151	85036	89405	5533699	89420	
14QK392AM3	85005	89430	20513881	85061	89450	25625151	89405		5554184	85302	89420
14QK392AM3	89430		20570098	83147		25625187	83209	89414	5554184	89420	
14QK392BM	85005	89430	20625775	85014		25625187	89414		57241-004	83110	
14QK392BM	89430		20782199	85072		25625223	83111		57241-006	83111	
14QK392BM2	85321		20863239	85080		25625234	83125		57241-006L	83111	
14QK392BM3	85005	89430	20873442	83050		25625241	83112		57241-4	83110	
14QK392BM3	89430		20874147	83050		25625254	83125		57241004	83110	
14QK392M	85005	89430	20897198	85061	89450	25625635	83045		57241006	83111	
14QK392M	89430		20973993	85061	89450	25625636	83045		57241006L	83111	
14QK393AM	83123	89405	20998401	85014		25625637	83045		572414	83110	
14QK393AM	89405		21002497	85972		25625743	85005	89430	5966-90044025	83209	89414
14QK393M	85010		21010744	83101		25625743	89430		5966-90044025	89414	
14QK396	85005	89430	21154393	83050		25626048	85080		596690044025	83209	89414
14QK396	89430		21155033	83101		25626149	85080		596690044025	89414	
14QK396M	85005	89430	21345868	83066		25626196	83142		60657-007	85072	
14QK396M	89430		21345869	83066		25631922	83007		60657007	85072	
14QK399M	83045		21436094	85927		25632145	85001	89410	60670-006	83147	
14QK399M2	83045		21436096	85061	89450	25632145	89410		60670-006L	83147	
14QK399M3	83045		21462382	85088		25632147	85305		60670006	83147	
14QK410M	83125		21462384	85088		25632561	83209	89414	60670006L	83147	
14QK410M2	83137		21490486	83066		25632561	89414		60675-001	85978	
14QK410M3	83125		21979343	85065		25633154	85906	89407	60675-001L	85978	
14QK411	83007		22202559	85088		25633154	89407		60675-13	85036	89405
14QK411AM	83007		22202560	85088		4103-5000447861	83105		60675-13	89405	
14QK411M	83007		22314111	85036	89405	4103-5000546892	83105		60675001	85978	
14QK413M	83111		22314111	89405		41035000447861	83105		60675001L	85978	
14QK413M4	83110		22662254	83901		41035000546892	83105		6067513	85036	89405
14QK413M6	83111		22662259	83901		446-51-211	85739		6067513	89405	
14QK413M7	83111		23030654	83910		44651211	85739		60680-003	83112	
14QK414M	85906	89407	23145372	83066		471700000426	85014		60680-003L	83112	
14QK414M	89407		23159760	85188		471700000430	89448		60680-004	83143	

**Important Note:** Competitive Interchanges are to be used for stocking purposes only. Where multiple crosses are identified, please reference the applications section of this catalog. / **Remarque importante:** Les interchanges concurrentiels ne s'utilisent qu'aux fins de stocks. Dans le cas de références multiples, consulter la section des applications du catalogue. / **Nota importante:** Dans le cas de referencias multiples, consultar la sección de aplicaciones del catálogo. / **Nota importante:** Se pueden usar intercambios competitivos para propósitos de almacenamiento solamente. Cuando se identifican intercambios múltiples, consulte la sección de aplicaciones de este catálogo.



**COMPETITIVE & O.E.M. INTERCHANGE LIST**  
**Lista de Intercambios contra Competidores y Equipo Original.**  
**Liste dinterchange de produits comptitifs & dquipement original (OEM)**

**Mack... cont'd**

Mack	Gabriel	Upgrade	Mack	Gabriel	Upgrade	Mack	Gabriel	Upgrade	Mack	Gabriel	Upgrade
60680-004L	83143		650107	85316	89426	650405	89415		78530771	83127	
60680-005	83142		650107	89426		650405MT	85023	89415	8083872	85978	
60680-005L	83142		650107MT	85316	89426	650405MT	89415		90045099	85906	89407
60680003	83112		650107MT	89426		650406	85024		90045099	89407	
60680003L	83112		650400MT	85033	89427	650408	85319	89428	H60680004	83143	
60680004	83143		650400MT	89427		650408	89428		H60680005	83142	
60680004L	83143		650402	85311	89424	650408MT	85319	89428	SDA141700000380	85061	89450
60680005	83142		650402	89424		650408MT	89428		SDA471700000431	85066	89448
60680005L	83142		650402MT	85311	89424	651012	83221		SDA471700000431	89448	
64838-002	85933	89454	650402MT	89424		651103	85036	89405	SDA471700002861	85014	
64838-002	89454		650404	85310	89423	651103	89405		V10234121	83105	
64838002	85933	89454	650404	89423		651151	83209	89414	V10242320	83105	
64838002	89454		650404MT	85310	89423	651151	89414				
650102	85001	89410	650404MT	89423		70042	85302	89420			
650102	89410		650405	85023	89415	70042	89420				

**Maeco**

Maeco	Gabriel	Upgrade	Maeco	Gabriel	Upgrade	Maeco	Gabriel	Upgrade	Maeco	Gabriel	Upgrade
1085	83214		16776	89406		70039	89422		70402	85305	
12608	83125		16777	85006		70041	85305		70642	85300	89419
12788	83216		16778	83203	89436	70042	85302	89420	70642	89419	
12866	83207	89407	16778	89436		70042	89420		70644	85334	
12866	89407		16779	83126	89430	70088	85307		70648	89414	
16385	83215		16779	89430		70123	85716		70650	89440	
1668722	85030	89440	16780	83123	89405	70127	85006		70651	85013	89414
1668722	89440		16780	89405		70128	85006		70651	89414	
16720	83107		16781	85006		70162	85716		70652	85030	89440
16767	85013	89414	16787	85030	89440	70163	85302	89420	70652	89440	
16767	89414		16787	89440		70163	89420		70663	85013	89414
16769	83221		16949	83120		70164	85716		70663	89414	
16770	83209	89414	6025	83122	89406	70300	85320	89429	70691	85007	
16770	89414		6025	89406		70300	89429		70720	85934	
16771	83126	89430	6026	83204		70312	85001	89410	70721	83125	
16771	89430		70018	85303	89422	70312	89410		74039	85303	89422
16772	83122	89406	70018	89422		70315	85063		74039	89422	
16772	89406		70021	85303	89422	70317	89402		OE10881	85711	
16773	85005	89430	70021	89422		70331	85314	89425	OE10882	85740	
16773	89430		70029	85308	89422	70331	89425		OE10883	85339	
16774	83215		70029	89422		70332	83314		OE12425	83214	
16775	83207	89407	70034	85302	89420	70334	85316	89426			
16775	89407		70034	89420		70334	89426				
16776	83122	89406	70039	85303	89422	70397	85006				

**MAN Bus**

Man bus	Gabriel	Upgrade	Man bus	Gabriel	Upgrade	Man bus	Gabriel	Upgrade	Man bus	Gabriel	Upgrade
134	85709		81-43701-6539	85708		81437016537	85709		81437016573	85722	
25-1700-106-654	85708		81-43701-6543	85708		81437016538	85708		81437016609	85709	
251700106654	85708		81-43701-6572	85708		81437016539	85708		9020M-1042	85709	
81-43701-6537	85709		81-43701-6573	85722		81437016543	85708		9020M1042	85709	
81-43701-6538	85708		81-43701-6609	85709		81437016572	85708				

**Mandalay Coach**

Mandalay coach	Gabriel	Upgrade	Mandalay coach	Gabriel	Upgrade	Mandalay coach	Gabriel	Upgrade	Mandalay coach	Gabriel	Upgrade
141700131809	85029		16-16873-000	85029		1616737000	83160		481700000490	85900	
141700131810	83160		16-16874-000	83160		1616873000	85029		481700000493	85900	
16-16736-000	85029		16-18103-000	85900		1616874000	83160				
16-16737-000	83160		1616736000	85029		1618103000	85900				

**Important Note:** Competitive Interchanges are to be used for stocking purposes only. Where multiple crosses are identified, please reference the applications section of this catalog. / **Remarque importante:** Les interchanges concurrentiels ne s'utilisent qu'aux fins de stocks. Dans le cas de rferences multiples, consulter la section des applications du catalogue. / **Nota importante:** En el caso de rferencias mltiples, consultar la seccion de aplicaciones del catalogo. / **Nota importante:** Se pueden usar intercambios competitivos para propósitos de almacenamiento solamente. Cuando se identifican intercambios mltiples, consulte la seccion de aplicaciones de este catalogo.

**COMPETITIVE & O.E.M. INTERCHANGE LIST**  
**Lista de Intercambios contra Competidores y Equipo Original.**  
**Liste dinterchange de produits compititifs & dquipement original (OEM)**

**Marathon**

Marathon	Gabriel	Upgrade	Marathon	Gabriel	Upgrade	Marathon	Gabriel	Upgrade	Marathon	Gabriel	Upgrade
43137-MB	83009		58093-MB	89427		58105-MB	85088		58122-MB	89440	
53010-MB	83136		58094-MB	85064		58107-MB	85958		58123-MB	85924	89457
53018-MB	83317		58095-MB	85066	89448	58113-MB	85052		58123-MB	89457	
53019-MB	83456	89447	58095-MB	89448		58114-MB	85934		72014-MB	83128	89436
53019-MB	89447		58096-MB	85067	89451	58115-MB	85937		72014-MB	89436	
53039-MB	85006		58096-MB	89451		58116-MB	85001	89410	72051-MB	83008	
53101-MB	83038		58097-MB	85069	89455	58116-MB	89410		78013-MB	85323	89436
53106-MB	83127		58097-MB	89455		58117-MB	85931	89458	78013-MB	89436	
53108-MB	85029		58098-MB	85045		58117-MB	89458		78015-MB	85724	89443
53109-MB	83125		58099-MB	85062	89408	58118-MB	85003	89411	78015-MB	89443	
58049-MB	85000	89436	58099-MB	89408		58118-MB	89411		78031-MB	85311	89424
58049-MB	89436		58100-MB	85933	89454	58119-MB	85061	89450	78031-MB	89424	
58064-MB	85070	89459	58100-MB	89454		58120-MB	85918	89449	78076-MB	85738	
58064-MB	89459		58101-MB	85938		58120-MB	89449		78077-MB	85310	89423
58085-MB	85072		58102-MB	85012	89413	58121-MB	85013	89414	78077-MB	89423	
58092-MB	85954		58102-MB	89413		58121-MB	89414		78078-MB	85320	89429
58093-MB	85033	89427	58103-MB	85900		58122-MB	85030	89440	78078-MB	89429	

**Marmon**

Marmon	Gabriel	Upgrade	Marmon	Gabriel	Upgrade	Marmon	Gabriel	Upgrade	Marmon	Gabriel	Upgrade
1-7001	83216		37-1-1	89406		51-163-7	83123	89405	511637	89405	
1202-0054	83021		3711	83122	89406	51-163-7	89405		576451	83122	89406
12020054	83021		3711	89406		5113928	85003	89411	576451	89406	
17001	83216		51-139-28	85003	89411	5113928	89411		665147	83216	
37-1-1	83122	89406	51-139-28	89411		511637	83123	89405			

**Matson School Bus**

Matson school bus	Gabriel	Upgrade	Matson school bus	Gabriel	Upgrade	Matson school bus	Gabriel	Upgrade	Matson school bus	Gabriel	Upgrade
5392387	85303	89422	5392387	89422							

**Maxpro**

Maxpro	Gabriel	Upgrade	Maxpro	Gabriel	Upgrade	Maxpro	Gabriel	Upgrade	Maxpro	Gabriel	Upgrade
17E-Z10042	85061	89450									

**Mc Neilus Truck & Man.**

Mc neilus truck & man.	Gabriel	Upgrade	Mc neilus truck & man.	Gabriel	Upgrade	Mc neilus truck & man.	Gabriel	Upgrade	Mc neilus truck & man.	Gabriel	Upgrade
060670-018	83166		1360386 MTM	89436		2034140 MTM	646155		40-6967	85030	89440
1139039 MTM	85334		1367383 MTM	83147		217330	85303	89422	40-6967	89440	
1139046 MTM	83112		1396513 MTM	85959		217330	89422		400242	83312	89409
1139059 MTM	83207	89407	1398980	83127		2173340	85303	89422	400242	89409	
1139059 MTM	89407		1398980 MTM	83127		2173340	89422		4036892	G63605	
1139069 MTM	83209	89414	1404068 MTM	85087		2218640	83009		404845	85304	
1139069 MTM	89414		1410046 MTM	85919		2218640 MTM	83009		404951	85316	89426
1170719	632147		1411765 MTM	83148		26228-A	83122	89406	404951	89426	
1202-0054	83021		1429317 MTM	85919		26228-A	89406		405348	85058	89431
12020054	83021		1431085 MTM	85738		26228A	83122	89406	405348	89431	
12405F	85734		1432386 MTM	85965		26228A	89406		406967	85030	89440
12405F-1	85303	89422	1433009 MTM	85962		2JD137	83119		406967	89440	
12405F-1	89422		1445910	85300	89419	3215395 MTM	83112		4HA569 MTM	85932	89453
12405F1	85303	89422	1445910	89419		3638112	G63183		4HA569 MTM	89453	
12405F1	89422		1468783 MTM	85345		3HR582 MTM	85013	89414	4KP398 MTM	85933	89454
12405FX1	85303	89422	1473224	646155		3HR582 MTM	89414		4KP398 MTM	89454	
12405FX1	89422		1485576 MTM	85979		3HR916 MTM	83207	89407	5353054	85303	89422
12405FX1 MTM	85303	89422	1491909 MTM	83128	89436	3HR916 MTM	89407		5353054	89422	
12405FX1 MTM	89422		1491909 MTM	89436		40-0242	83312	89409	5361994	85734	
1323106 MTM	85305		1573270	83207	89407	40-0242	89409		5HA994 MTM	85916	89430
1333575 MTM	85072		1573270	89407		40-4845	85304		5HA994 MTM	89430	
1340975 MTM	83142		1573280	83221		40-4951	85316	89426			
1340976 MTM	85919		1583470	85051		40-4951	89426				
1340979 MTM	83143		1KK552 MTM	85967		40-5348	85058	89431			
1360386 MTM	85323	89436	2034140	646177		40-5348	89431				

**Important Note:** Competitive Interchanges are to be used for stocking purposes only. Where multiple crosses are identified, please reference the applications section of this catalog. / **Remarque importante:** Les interchanges concurrentiels ne s'utilisent qu'aux fins de stocks. Dans le cas de références multiples, consulter la section des applications du catalogue. / **Nota importante:** Dans le cas de referencias multiples, consultar la sección de aplicaciones del catálogo. / **Nota importante:** Se pueden usar intercambios competitivos para propósitos de almacenamiento solamente. Cuando se identifican intercambios múltiples, consulte la sección de aplicaciones de este catálogo.

**COMPETITIVE & O.E.M. INTERCHANGE LIST**  
**Lista de Intercambios contra Competidores y Equipo Original.**  
**Liste dinterchange de produits comptitifs & dquipement original (OEM)**

**Mc Neilus Truck & Man.... cont'd**

Mc neilus truck & man.	Gabriel	Upgrade	Mc neilus truck & man.	Gabriel	Upgrade	Mc neilus truck & man.	Gabriel	Upgrade	Mc neilus truck & man.	Gabriel	Upgrade
5HB645 MTM	83109		651444	83221		6HB390 MTM	83137		7HS534 MTM	89407	
5KK247 MTM	85977		665040	85303	89422	6HD720 MTM	85909		8KK524 MTM	83168	
600-115994B	632147		665040	89422		6HS773 MTM	83122	89406	90044448	85051	
600-11599M	632147		665060	83122	89406	6HS773 MTM	89406		9HB362 MTM	85976	
600-188206	646155		665060	89406		6KP857 MTM	85000	89436	9KK464 MTM	85079	
60670-018	83166		690049	85303	89422	6KP857 MTM	89436		MB-37737-30	646155	
60670018	83166		690049	89422		7HS237 MTM	83122	89406	P117099	83120	
64442AX MTM	83128	89436	6HA961 MTM	83123	89405	7HS237 MTM	89406		RW24285	83119	
64442AX MTM	89436		6HA961 MTM	89405		7HS534 MTM	85906	89407			

**Meritor**

Meritor	Gabriel	Upgrade	Meritor	Gabriel	Upgrade	Meritor	Gabriel	Upgrade	Meritor	Gabriel	Upgrade
14QK-3100	85739		M83124	83124	89407	M85046	89434		M85732	85732	
14QK3100	85739		M83124	89407		M85047	85047	89435	M85738	85738	
202447	85919		M83125	83125		M85047	89435		M85900	85900	
21227751	87015		M83127	83127		M85052	85052		M85901	85901	
446-51-211	85739		M83128	83128	89436	M85053	85053	89442	M85902	85902	
44651211	85739		M83128	89436		M85053	89442		M85909	85909	
671020	87015		M83130	83130		M85058	85058	89431	M85918	85918	89449
671506	86200		M83135	83135		M85058	89431		M85918	89449	
671507	87015		M83136	83136		M85061	85061	89450	M85919	85919	
671907	85919		M83147	83147		M85062	85062	89408	M85920	85920	89503
680705	85737		M83203	83203	89436	M85062	89408		M85920	89503	
700115	85712		M83203	89436		M85064	85064		M85923	85923	89458
7805-F-1020	86200		M83207	83207	89407	M85066	85066	89448	M85923	89458	
7805F1020	86200		M83207	89407		M85066	89448		M85924	85924	89457
A-3280-M-9711	85919		M83209	83209	89414	M85067	85067	89451	M85924	89457	
A-7805F-1020	86200		M83209	89414		M85067	89451		M85927	85927	
A-7805L-1000	85919		M83215	83215		M85069	85069	89455	M85929	85929	
A-7805L-1026	87015		M83456	83456	89447	M85069	89455		M85931	85931	89458
A-7805P-1030	85737		M83456	89447		M85070	85070	89459	M85931	89458	
A3280M9711	85919		M83613	83613		M85070	89459		M85933	85933	89454
A7805F1020	86200		M85000	85000	89436	M85072	85072		M85933	89454	
A7805L1000	85919		M85000	89436		M85300	85300	89419	M85934	85934	
A7805L1026	87015		M85001	85001	89410	M85300	89419		M85936	85936	89456
A7805P1030	85737		M85001	89410		M85301	85301		M85936	89456	
KIT11210	87015		M85003	85003	89411	M85303	85303	89422	M85937	85937	
KIT11375	86200		M85003	89411		M85303	89422		M85954	85954	
KIT11376	86200		M85005	85005	89430	M85305	85305		M85957	85957	
KIT11389	86200		M85005	89430		M85310	85310	89423	M85964	85964	
KIT11402	86200		M85006	85006		M85310	89423		M89408	89408	
M646155	646155		M85007	85007		M85311	85311	89424	M89410	89410	
M83001	83001		M85012	85012	89413	M85311	89424		M89411	89411	
M83008	83008		M85012	89413		M85316	85316	89426	M89413	89413	
M83009	83009		M85013	85013	89414	M85316	89426		M89414	89414	
M83021	83021		M85013	89414		M85319	85319	89428	M89423	89423	
M83025	83025		M85014	85014		M85319	89428		M89424	89424	
M83028	83028		M85026	85026		M85320	85320	89429	M89427	89427	
M83029	83029		M85029	85029		M85320	89429		M89429	89429	
M83038	83038		M85030	85030	89440	M85323	85323	89436	M89430	89430	
M83041	83041		M85030	89440		M85323	89436		M89436	89436	
M83110	83110		M85033	85033	89427	M85331	85331		M89443	89443	
M83111	83111		M85033	89427		M85333	85333		M89448	89448	
M83112	83112		M85036	85036	89405	M85708	85708		M89449	89449	
M83122	83122	89406	M85036	89405		M85724	85724	89443			
M83122	89406		M85043	85043		M85724	89443				
M83123	83123	89405	M85045	85045		M85727	85727				
M83123	89405		M85046	85046	89434	M85729	85729				

**Important Note:** Competitive Interchanges are to be used for stocking purposes only. Where multiple crosses are identified, please reference the applications section of this catalog. / **Remarque importante:** Les interchanges concurrentiels ne s'utilisent qu'aux fins de stocks. Dans le cas de références multiples, consulter la section des applications du catalogue. / **Nota importante:** En el caso de referencias múltiples, consultar la sección de aplicaciones del catálogo. / **Nota importante:** Se pueden usar intercambios competitivos para propósitos de almacenamiento solamente. Cuando se identifican intercambios múltiples, consulte la sección de aplicaciones de este catálogo.

# COMPETITIVE & O.E.M. INTERCHANGE LIST

## Lista de Intercambios contra Competidores y Equipo Original.

### Liste d'interchange de produits compétitifs & d'équipement original (OEM)

#### Meritor... cont'd

Meritor	Gabriel	Upgrade	Meritor	Gabriel	Upgrade	Meritor	Gabriel	Upgrade	Meritor	Gabriel	Upgrade
M89450	89450		M89451	89451							

#### Mitsubishi Fuso

Mitsubishi fuso	Gabriel	Upgrade	Mitsubishi fuso	Gabriel	Upgrade	Mitsubishi fuso	Gabriel	Upgrade	Mitsubishi fuso	Gabriel	Upgrade
MB161497	G63299		MC114595	G63405		MC813135	83456	89447	MC826268	G63610	
MC091947	83162		MC714595	G63405		MC813135	89447		MK302296	G63610	
MC091950	83162		MC809390	83103		MC814614	85009		MK433638	G63610	

#### Mohawk

Mohawk	Gabriel	Upgrade	Mohawk	Gabriel	Upgrade	Mohawk	Gabriel	Upgrade	Mohawk	Gabriel	Upgrade
01-0100-905	85303	89422	22012082	85702		97-9999-02320	85704		MM6886	83207	89407
01-0100-905	89422		22012114	85700		97220100011	85704		MM6886	89407	
010100905	85303	89422	4968853	83216		97999902320	85704		MM6957	83225	
010100905	89422		6-367-7	85305		MM-6886	83207	89407	MM74029	85308	89422
020273544	83203	89436	63677	85305		MM-6886	89407		MM74029	89422	
020273544	89436		680323	85700		MM-6957	83225				
050134508	85732		680485	85733		MM-74029	85308	89422			
1235233	85736		97-2201-00011	85704		MM-74029	89422				

#### Monaco

Monaco	Gabriel	Upgrade	Monaco	Gabriel	Upgrade	Monaco	Gabriel	Upgrade	Monaco	Gabriel	Upgrade
01809924	83144		9U9Z-18124-A	83209	89414	ASH-25824	83122	89406	AT-620	83209	89414
01809925	85010		9U9Z-18124-A	89414		ASH-25824	89406		AT-620	89414	
1C34-18045-AA	83209	89414	9U9Z-18125-A	83122	89406	ASH-294	83209	89414	AT-621	83122	89406
1C34-18045-AA	89414		9U9Z-18125-A	89406		ASH-294	89414		AT-621	89406	
1C34-18045-JA	83209	89414	9U9Z18124A	83209	89414	ASH1022	83209	89414	AT-766	83209	89414
1C34-18045-JA	89414		9U9Z18124A	89414		ASH1022	89414		AT-766	89414	
1C3418045AA	83209	89414	9U9Z18125A	83122	89406	ASH1023	83122	89406	AT620	83209	89414
1C3418045AA	89414		9U9Z18125A	89406		ASH1023	89406		AT620	89414	
1C3418045JA	83209	89414	ASH-1022	83209	89414	ASH1205	83209	89414	AT621	83122	89406
1C3418045JA	89414		ASH-1022	89414		ASH1205	89414		AT621	89406	
24-153249	85125		ASH-1023	83122	89406	ASH1206	83122	89406	AT766	83209	89414
24-153256	85124		ASH-1023	89406		ASH1206	89406		AT766	89414	
24-186629	85125		ASH-1205	83209	89414	ASH1228	83209	89414	F4-BE5-A832-MO	85125	
24153249	85125		ASH-1205	89414		ASH1228	89414		F4-BE5-B492-HO	85125	
24153256	85124		ASH-1206	83122	89406	ASH1229	83209	89414	F4-BE5-C832-MO	83124	89407
24186629	85125		ASH-1206	89406		ASH1229	89414		F4-BE5-C832-MO	89407	
66153-002	83124	89407	ASH-1228	83209	89414	ASH1230	83122	89406	F4-BE5-F324-HO	85125	
66153-002	89407		ASH-1228	89414		ASH1230	89406		F4-BE5-F325-HO	85124	
66153002	83124	89407	ASH-1229	83209	89414	ASH137	83122	89406	F4BE5A832MO	85125	
66153002	89407		ASH-1229	89414		ASH137	89406		F4BE5B492HO	85125	
9U94-18045-AA	83209	89414	ASH-1230	83122	89406	ASH25822	83209	89414	F4BE5C832MO	83124	89407
9U94-18045-AA	89414		ASH-1230	89406		ASH25822	89414		F4BE5C832MO	89407	
9U94-18080-AA	83122	89406	ASH-137	83122	89406	ASH25823	83209	89414	F4BE5F324HO	85125	
9U94-18080-AA	89406		ASH-137	89406		ASH25823	89414		F4BE5F325HO	85124	
9U9418045AA	83209	89414	ASH-25822	83209	89414	ASH25824	83122	89406	W0005662	85125	
9U9418045AA	89414		ASH-25822	89414		ASH25824	89406		W0005663	85124	
9U9418080AA	83122	89406	ASH-25823	83209	89414	ASH294	83209	89414	W0006254	85125	
9U9418080AA	89406		ASH-25823	89414		ASH294	89414				

#### Monroe

Monroe	Gabriel	Upgrade	Monroe	Gabriel	Upgrade	Monroe	Gabriel	Upgrade	Monroe	Gabriel	Upgrade
1000	82156		139112	G57000		16767	85013	89414	16773	85005	89430
1085	83214		1401	58423		16767	89414		16773	89430	
12608	83125		1401	61531		16769	83221		16774	83215	
12788	83216		1401	81516		16770	83209	89414	16775	83207	89407
12866	83207	89407	16385	83215		16770	89414		16775	89407	
12866	89407		1668722	85030	89440	16771	83126	89430			
12872	83219		1668722	89440		16771	89430				
139104	G57125		16720	83107		16772	83122	89406			
139105	G57023		16721	83125		16772	89406				

**Important Note:** Competitive Interchanges are to be used for stocking purposes only. Where multiple crosses are identified, please reference the applications section of this catalog. / **Remarque importante:** Les interchanges concurrentiels ne s'utilisent qu'aux fins de stocks. Dans le cas de références multiples, consulter la section des applications du catalogue. / **Nota importante:** Dans le cas de referencias multiples, consultar la sección de aplicaciones del catálogo. / **Nota importante:** Se pueden usar intercambios competitivos para propósitos de almacenamiento solamente. Cuando se identifican intercambios múltiples, consulte la sección de aplicaciones de este catálogo.

**COMPETITIVE & O.E.M. INTERCHANGE LIST**  
**Lista de Intercambios contra Competidores y Equipo Original.**  
**Liste dinterchange de produits compititifs & dquipement original (OEM)**

**Monroe... cont'd**

Monroe	Gabriel	Upgrade	Monroe	Gabriel	Upgrade	Monroe	Gabriel	Upgrade	Monroe	Gabriel	Upgrade
16776	83122	89406	171341	G57022		171494	G57649		171957	G56933	
16776	89406		171346	G57080		171495	G57648		171958	G56932	
16777	85006		171347L	G57220		171504	G57064		172103	G57613	
16778	83203	89436	171347R	G57221		171505	G57063		172104	G57612	
16778	89436		171348L	G57027		171525	G57039		172105	G57035	
16779	83126	89430	171348R	G57027		171572L	G56956		172106	G57034	
16779	89430		171351L	G57065		171572R	G56957		172107	G57035	
16780	83123	89405	171351R	G57066		171575	G57397		172108	G57034	
16780	89405		171352L	G57010		171577L	G57007		172113	G57274	
16781	85006		171352R	G57010		171577R	G57008		172114	G57115	
16787	85030	89440	171353	G57282		171578	G56973		172115	G57114	
16787	89440		171358	G57092		171579	G56974		172116	G57357	
16949	83120		171359	G57036		171580	G56975		172117	G57358	
171100	G57146		171361	G57020		171581	G57364		172123L	G57054	
171101L	G57425		171362	G57021		171582	G57363		172123R	G57055	
171101R	G57424		171369	G57015		171584	G57279		172124	G57050	
171102	G57413		171370	G57016		171585	G57278		172125	G57049	
171102	G57647		171371L	G57133		171592	G56965		172130L	G57112	
171103	G57118		171371R	G57134		171593	G57046		172130R	G57113	
171111	G57053		171372	G57056		171594	G57045		172135	G57222	
171114L	G57444		171373L	G57067		171597	G57012		172136	G57223	
171119L	G57123		171373R	G57068		171598	G57011		172138	G57271	
171119R	G57124		171377L	G57083		171615	G56934		172143	G57085	
171124	G57095		171377R	G57083		171615	G56937		172144	G57084	
171125	G57096		171380L	G57086		171616	G56936		172170	G57489	
171126	G57447		171380R	G57087		171661	G57060		172171	G57490	
171128L	G57206		171398	G57019		171662L	G56924		172177	G57141	
171128R	G57206		171400	G57269		171662R	G56925		172179L	G57047	
171130	G57466		171401	G57268		171665	G56929		172179R	G57048	
171131	G57465		171404	G57089		171667	G56963		172185	G57050	
171137L	G57454		171405	G57088		171668	G56962		172186	G57049	
171137R	G57453		171406	G57168		171669	G56964		172191	G57399	
171138	G57172		171407	G57167		171670	G57060		172192	G57398	
171139	G57173		171417	G57059		171671L	G56924		172194	G57400	
171140	G57132		171426	G57031		171671R	G56925		172195	G57270	
171141	G57103		171427	G57030		171672	G56927		172199	G57070	
171266	G56995		171433	G57050		171674	G57559		172199	G57122	
171281	G56938		171433	G57522		171675	G57558		172200	G57069	
171282	G57422		171434	G57049		171678	G56931		172200	G57121	
171291L	G56996		171434	G57521		171679	G56930		172203	G57099	
171291R	G56997		171435	G57140		171680	G56933		172203	G57100	
171292	G56998		171436	G57139		171681	G56932		172205	G57077	
171293	G57057		171437	G57098		171684	G57051		172206	G57076	
171293	G57058		171438	G57097		171685	G57051		172207	G57079	
171299	G56943		171441	G57145		171686	G56928		172208	G57078	
171312	G57036		171442	G57144		171691L	G56991		172209	G57111	
171313	G57026		171451	G57120		171691R	G56992		172210	G57110	
171313	G57075		171452	G57119		171798	G56726		172213	G57153	
171321	G57017		171453	G57106		171920	G56935		172214	G57152	
171322	G63679		171454	G57105		171924	G57013		172219	G57219	
171327	G57159		171461	G57158		171925	G57014		172220	G57218	
171327	G57160		171462	G57157		171933	G57006		172221	G57343	
171340L	G57032		171490	G57042		171945	G56994		172222	G57344	
171340L	G57061		171491	G57041		171946	G56993		172231	G57142	
171340R	G57033		171492	G57044		171953	G56950		172236	G57372	
171340R	G57062		171493	G57043		171954	G56949		172237	G57373	

**Important Note:** Competitive Interchanges are to be used for stocking purposes only. Where multiple crosses are identified, please reference the applications section of this catalog./ **Remarque importante:** Les interchanges concurrentiels ne s'utilisent qu'aux fins de stocks. Dans le cas de rfrences multiples, consulter la section des applications du catalogue./ **Nota importante:** Dans le cas de rfrences multiples, consulter la section des applications du catalogue./ **Nota importante:** Se pueden usar intercambios competitivos para propósitos de almacenamiento solamente. Cuando se identifican intercambios múltiples, consulte la sección de aplicaciones de este catálogo.

**COMPETITIVE & O.E.M. INTERCHANGE LIST**  
**Lista de Intercambios contra Competidores y Equipo Original.**  
**Liste d'interchange de produits compétitifs & d'équipement original (OEM)**

**Monroe... cont'd**

Monroe	Gabriel	Upgrade	Monroe	Gabriel	Upgrade	Monroe	Gabriel	Upgrade	Monroe	Gabriel	Upgrade
172240	G57031		172391	G57369		172600R	G57452		172903	G57060	
172241	G57030		172392	G57162		172604	G57494		172905	G57368	
172242	G57674		172393	G57161		172605	G57493		172906	G57367	
172243	G57673		172398L	G57414		172608	G57474		172907	G57727	
172248	G57071		172398R	G57415		172609	G57473		172908	G57726	
172248	G57072		172400L	G57428		172618	G57518		172919	G57748	
172257	G57082		172400R	G57429		172619	G57517		172942	G57500	
172258	G57081		172401	G57178		172620	G57694		172943	G57499	
172261	G57148		172408	G57071		172621	G57693		172949	G57709	
172267	G57164		172433	G57561		172624	G57456		172950	G57794	
172268	G57163		172434	G57560		172625	G57455		172951	G57795	
172271	G57185		172448	G57126		172626	G57378		172957L	G57597	
172272	G57184		172449	G57127		172627	G57377		172957R	G57598	
172275	G57205		172450	G57128		172647	G57696		172962	G57677	
172276	G57204		172451	G57129		172648	G57695		172963	G57676	
172278	G57142		172471L	G56924		172652L	G57683		172964	G57659	
172281	G57149		172471R	G56925		172652R	G57683		172965	G57658	
172284	G57391		172485	G57484		172653	G57746		172966	G57659	
172285	G57390		172486	G57483		172654	G57747		172967	G57658	
172286	G57391		172489	G57659		172663	G57378		172974	G57606	
172287	G57390		172490	G57658		172664	G57377		172975	G57605	
172292	G57147		172497L	G57416		172670	G57723		172980	G57376	
172295	G57131		172497R	G57682		172671	G57722		172981	G57375	
172296	G57130		172497R	G57691		172678	G57629		172985	G57853	
172297	G57276		172498	G57345		172679	G57628		172986	G57852	
172298	G57275		172499	G57346		172680	G57645		172989	G57544	
172299	G57472		172501	G57423		172681	G57644		172990	G57543	
172300	G57471		172509	G57266		172686	G57340		173032L	G57683	
172305	G57394		172510	G57267		172687	G57339		173032R	G57683	
172306	G57393		172518	G57109		172688	G57739		181100	G57146	
172307	G57191		172522	G57727		172689	G57738		181101L	G57425	
172308	G57190		172523	G57726		172695	G57706		181101R	G57424	
172309	G57193		172526	G57198		172708	G57743		181102	G57646	
172310	G57192		172527	G57197		172709	G57742		181111	G57053	
172311	G57156		172530	G57498		172712	G57690		181119L	G57123	
172311	G57277		172532	G57498		172713	G57689		181119R	G57124	
172332	G57466		172533	G57498		172727	G57495		181124	G57095	
172333	G57465		172536	G57138		172728	G57496		181125	G57096	
172343	G57334		172537	G57137		172729	G57820		181126	G57447	
172344	G57333		172541	G57565		172730	G57819		181128L	G57206	
172345	G57460		172542	G57564		172741	G57193		181128R	G57206	
172346	G57459		172546L	G57749		172742	G57192		181138	G57172	
172351	G57202		172546R	G57825		172743	G57725		181140	G57132	
172352	G57203		172562L	G57417		172744	G57724		181141	G57103	
172357	G57405		172562R	G57418		172763	G57153		181266	G56995	
172363	G57664		172563	G57419		172764	G57152		181274	G56951	
172364	G57663		172565	G57340		172765	G57562		181281	G56938	
172365	G57376		172566	G57339		172766	G57563		181291L	G56996	
172366	G57375		172568	G57456		172780L	G57206		181291R	G56997	
172367	G57177		172569	G57455		172780R	G57206		181292	G56998	
172368	G57176		172596	G57427		172781	G57733		181293	G57057	
172378	G57201		172597	G57330		172782	G57732		181293	G57058	
172379	G57200		172598	G57329		172783	G57731		181299	G56943	
172384	G57190		172599L	G57451		172784	G57730		181312	G57036	
172385	G57192		172599R	G57452		172901	G57546		181313	G57026	
172390	G57370		172600L	G57451		172902	G57545		181321	G57017	

**Important Note:** Competitive Interchanges are to be used for stocking purposes only. Where multiple crosses are identified, please reference the applications section of this catalog. / **Remarque importante:** Les interchanges concurrentiels ne s'utilisent qu'aux fins de stocks. Dans le cas de références multiples, consulter la section des applications du catalogue. / **Nota importante:** Dans le cas de références multiples, consulter la section des applications du catalogue. / **Nota importante:** Se pueden usar intercambios competitivos para propósitos de almacenamiento solamente. Cuando se identifican intercambios múltiples, consulte la sección de aplicaciones de este catálogo.

**COMPETITIVE & O.E.M. INTERCHANGE LIST**  
**Lista de Intercambios contra Competidores y Equipo Original.**  
**Liste dinterchange de produits comptitifs & dquipement original (OEM)**

**Monroe... cont'd**

Monroe	Gabriel	Upgrade	Monroe	Gabriel	Upgrade	Monroe	Gabriel	Upgrade	Monroe	Gabriel	Upgrade
181322	G57018		181577R	G57008		182138	G57271		182321	G57324	
181327	G57159		181578	G56973		182143	G57085		182351	G57203	
181340L	G57061		181579	G56974		182144	G57084		182352	G57202	
181340R	G57062		181580	G56975		182174	G56951		182357	G57405	
181341	G57022		181584	G57279		182177	G57141		182358	G57404	
181346	G57080		181585	G57278		182179L	G57047		182363	G57664	
181347L	G57220		181592	G56965		182179R	G57048		182364	G57663	
181347R	G57221		181593	G57045		182185	G57050		182365	G57376	
181348L	G57027		181594	G57046		182186	G57049		182366	G57375	
181348R	G57027		181597	G57012		182199	G57070		182367	G57464	
181351L	G57065		181598	G57011		182200	G57069		182368	G57463	
181351R	G57066		181615	G56934		182203	G57099		182378	G57201	
181352L	G57010		181615	G56937		182205	G57077		182379	G57200	
181352R	G57010		181616	G56936		182206	G57076		182392	G57162	
181353	G57282		181661	G57060		182207	G57079		182393	G57161	
181358	G57092		181662L	G56924		182208	G57078		182401	G57178	
181361	G57020		181662R	G56925		182209	G57111		182471L	G56924	
181362	G57021		181665	G56929		182210	G57110		182471R	G56925	
181369	G57212		181667	G56963		182215	G57533		182497L	G57416	
181371L	G57133		181668	G56962		182216	G57534		182497R	G57691	
181371R	G57134		181669	G56964		182219	G57219		182509	G57266	
181372	G57056		181670	G57060		182220	G57218		182510	G57267	
181373L	G57067		181671L	G56924		182221	G57343		182518	G57109	
181373R	G57068		181671R	G56925		182222	G57344		182526	G57197	
181380L	G57086		181672	G56927		182231	G57142		182527	G57198	
181380R	G57087		181674	G57559		182236	G57372		182530	G57498	
181398	G57019		181675	G57558		182237	G57373		182536	G57138	
181400	G57269		181678	G56931		182240	G57031		182537	G57137	
181401	G57268		181679	G56930		182241	G57030		182562L	G57207	
181404	G57089		181680	G56933		182248	G57071		182562R	G57208	
181405	G57088		181681	G56932		182257	G57082		182563	G57419	
181406	G57168		181685	G57051		182258	G57081		182596	G57427	
181407	G57167		181686	G56928		182261	G57148		182597	G57329	
181417	G57059		181691L	G56991		182267	G57164		182598	G57330	
181426	G57031		181691R	G56992		182268	G57163		189105	G57023	
181427	G57030		181784	G57125		182271	G57185		250132	81582	
181435	G57140		181920	G56935		182272	G57184		250186	81482	
181436	G57139		181924	G57013		182275	G57205		250194	81750	
181451	G57120		181925	G57014		182276	G57204		250290	81878	
181452	G57119		181945	G56994		182281	G57149		250300	81750	
181453	G57106		181946	G56993		182284	G57391		250302	81912	
181454	G57105		181953	G56950		182285	G57390		250303	81892	
181461	G57158		181954	G56949		182286	G57391		250322	61614	
181462	G57157		181957	G56933		182287	G57390		250984	81934	
181490	G57042		181958	G56932		182292	G57147		271100	G57409	
181491	G57041		182105	G57035		182295	G57131		271102	G57646	
181492	G57044		182106	G57034		182296	G57130		271124	G57095	
181493	G57043		182113	G57274		182297	G57276		271125	G57096	
181494	G57649		182114	G57115		182298	G57275		271128L	G57206	
181495	G57648		182115	G57114		182305	G57394		271128R	G57206	
181504	G57064		182123L	G57054		182306	G57393		271130	G57466	
181505	G57063		182123R	G57055		182307	G57191		271131	G57465	
181525	G57039		182130L	G57112		182308	G57190		271137L	G57454	
181572L	G56956		182130R	G57113		182309	G57193		271137R	G57453	
181572R	G56957		182135	G57223		182310	G57192		271139	G57173	
181577L	G57007		182136	G57222		182311	G57156		271311	G57026	

**Important Note:** Competitive Interchanges are to be used for stocking purposes only. Where multiple crosses are identified, please reference the applications section of this catalog. / **Remarque importante:** Les interchanges concurrentiels ne s'utilisent qu'aux fins de stocks. Dans le cas de rfrences multiples, consulter la section des applications du catalogue. / **Nota importante:** Dans le cas de rfrences multiples, consulter la section des applications du catalogue. / **Nota importante:** Se pueden usar intercambios competitivos para propósitos de almacenamiento solamente. Cuando se identifican intercambios múltiples, consulte la sección de aplicaciones de este catálogo.



**COMPETITIVE & O.E.M. INTERCHANGE LIST**  
**Lista de Intercambios contra Competidores y Equipo Original.**  
**Liste dinterchange de produits comptitifs & dquipement original (OEM)**

**Monroe... cont'd**

Monroe	Gabriel	Upgrade	Monroe	Gabriel	Upgrade	Monroe	Gabriel	Upgrade	Monroe	Gabriel	Upgrade
271326L	G57090		272401	G57607		281131	G57465		32080	81242	
271326R	G57091		272408	G57071		281311	G57026		32103	82130	
271341	G57022		272412	G57635		281426	G57031		32112	81095	
271346	G57080		272413	G57634		281427	G57030		32113	61501	
271353	G57282		272471L	G56924		281616	G56936		32113	61508	
271358	G57092		272471R	G56925		281662L	G56924		32113	81478	
271371L	G57133		272483	G57482		281662R	G56925		32118	82128	
271371R	G57134		272484	G57481		281670	G57060		32126	81340	
271426	G57031		272489	G57484		281678	G56931		32126	82039	
271427	G57030		272490	G57483		281679	G56930		32127	61523	
271435	G57140		272491	G57331		281680	G56933		32127	81096	
271436	G57139		272492	G57332		281681	G56932		32127	81834	
271441	G57145		272501	G57423		281951	G56948		32128	81091	
271442	G57144		272526	G57198		281952	G56948		32132	61529	
271453	G57349		272527	G57197		282257	G57082		32132	81494	
271454	G57350		272532	G57498		282258	G57081		32132	81582	
271525	G57039		272533	G57497		282261	G57148		32132	81750	
271575	G57397		272534	G57496		282275	G57205		32134	81153	
271577L	G57007		272535	G57495		282276	G57204		32143	81495	
271577R	G57008		272562L	G57417		282299	G57472		32164	61519	
271616	G56936		272562R	G57418		282300	G57471		32164	81484	
271662L	G56924		272565	G57340		282307	G57191		32186	61528	
271662R	G56925		272566	G57339		282308	G57190		32186	81482	
271670	G57060		272568	G57456		282491	G57480		32194	61531	
271678	G56931		272569	G57455		282492	G57479		32194	81516	
271679	G56930		272596	G57427		3100	G63907		32196	61535	
271680	G56933		272597	G57330		31000	61500		32196	61615	
271681	G56932		272598	G57329		31000	81147		32196	81548	
271951	G56948		272599L	G57451		31000	82156		32196	81936	
271952	G56948		272599R	G57452		31029	81675		32197	61536	
272162	G57635		272604	G57494		31069	81270		32197	81549	
272163	G57634		272605	G57493		31069	82076		32202	69755	
272213	G57587		272621	G57691		31089	82001		32206	61501	
272214	G57586		272626	G57378		31094	61506		32206	81478	
272215	G57587		272627	G57377		31094	81318		32206	81507	
272216	G57586		272638	G57812		31094	82012		32207	61550	
272257	G57082		272679	G57704		31125	82125		32207	81676	
272258	G57081		272684	G57673		31131	61632		32207	82007	
272261	G57148		272685	G57674		31131	81469		32211	81583	
272275	G57205		272686	G57340		31131	81825		32212	61539	
272276	G57204		272687	G57339		31163	81416		32214	61512	
272288	G57353		272712	G57690		31163	81440		32214	81559	
272289	G57354		272713	G57689		31538	82005		32215	81560	
272297	G57276		272730	G57819		31542	82001		32216	81491	
272298	G57275		272748	G57518		32022	82090		32217	61593	
272305	G57394		272749	G57517		32066	61529		32217	81507	
272306	G57393		272750	G57518		32066	61555		32217	81553	
272307	G57191		272751	G57517		32066	81446		32217	81872	
272308	G57190		272889	G57583		32066	81541		32219	81691	
272309	G57193		272919	G57748		32066	81713		32220	61541	
272345	G57460		272957L	G57792		32066	82099		32220	81583	
272346	G57459		272957R	G57793		32067	82601		32224	61544	
272367	G57463		272974	G57120		32073	82131		32224	81668	
272368	G57464		272975	G57119		32075	61521		32225	61543	
272384	G57192		281100	G57409		32075	81394		32225	81667	
272385	G57192		281130	G57466		32080	61518		32226	61520	

**Important Note:** Competitive Interchanges are to be used for stocking purposes only. Where multiple crosses are identified, please reference the applications section of this catalog. / **Remarque importante:** Les interchanges concurrentiels ne s'utilisent qu'aux fins de stocks. Dans le cas de références multiples, consulter la section des applications du catalogue. / **Nota importante:** Dans le cas de références multiples, consulter la section des applications du catalogue. / **Nota importante:** Se pueden usar intercambios competitivos para propósitos de almacenamiento solamente. Cuando se identifican intercambios múltiples, consulte la sección de aplicaciones de este catálogo.

**COMPETITIVE & O.E.M. INTERCHANGE LIST**  
**Lista de Intercambios contra Competidores y Equipo Original.**  
**Liste d'interchange de produits compititifs & d'equipement original (OEM)**

**Monroe... cont'd**

Monroe	Gabriel	Upgrade	Monroe	Gabriel	Upgrade	Monroe	Gabriel	Upgrade	Monroe	Gabriel	Upgrade
32226	77414		32267	61591		32317	81713		32355	14039	
32226	81490		32267	81744		32318	61512		32356	G63614	
32227	61520		32268	61646		32318	81559		32356	G63622	
32227	81490		32268	81828		32319	61658		32357	58808	
32228	61554		32269	61575		32319	81923		32357	61654	
32228	81710		32269	81891		32321	61658		32358	58809	
32231	61547		32270	61582		32321	81923		32358	61655	
32231	81082		32271	81872		32322	61614		32359	58810	
32231	81710		32272	61608		32323	61614		32359	61656	
32235	61561		32273	G63782		32324	61638		32360	81082	
32235	81744		32274	G63781		32324	81892		32361	G63394	
32237	61533		32275	61625		32325	61612		32362	61685	
32237	61627		32277	61599		32325	81913		32362	81668	
32237	81730		32277	81928		32326	61641		32365	61642	
32237	81917		32278	61600		32326	81920		32365	81921	
32238	61573		32278	81873		32327	61600		32366	61635	
32238	61629		32279	61634		32327	81873		32366	81919	
32238	81540		32279	81919		32327R	81873		32369	G63616	
32238	81905		32280	61520		32328	58803		32370	G63692	
32238	81918		32280	61613		32328	61643		32371	61523	
32239	61530		32280	81490		32328	81922		32371	81096	
32239	81510		32281	82147		32329	81921		32372	61547	
32243	61520		32283	G63510		32330	61626		32372	81082	
32243	81490		32284	G63387		32330	81916		32372	81507	
32245	61552		32285	61521		32332	61614		32373	61542	
32245	81870		32287	G63432		32333	61659		32373	81726	
32247	61510		32288	61614		32333	81924		32375	81342	
32247	81871		32288	81821		32334	G63726		32376	81834	
32249	61593		32290	61605		32335	81910		32377	82007	
32249	81872		32290	81878		32336	61593		32379	G63411	
32250	61601		32292	61606		32336	81872		32380	G63675	
32250	61679		32293	61500		32337	81911		32381	61520	
32250	81836		32294	61700		32338	61664		32381	61546	
32251	61584		32295	61699		32338	81869		32383	61509	
32251	81837		32296	61623		32339	61676		32383	81541	
32252	61535		32296	61626		32339	81926		32385	81091	
32252	81548		32296	81893		32340	61663		32386	81510	
32253	61590		32300	61504		32340	81920		32388	G64027	
32253	61624		32300	81750		32341	61642		32389	G64028	
32253	81890		32301	82003		32341	81921		32390	81933	
32254	61542		32302	61611		32344	61675		32390R	81933	
32254	81726		32302	81912		32344	81930		32391	61691	
32258	61504		32303	61638		32345	61642		32391	61692	
32258	61556		32303	81892		32345	61675		32391	81931	
32258	81750		32303R	81892		32345	81921		32392	81932	
32259	61626		32304	61613		32345	81930		32393	G63607	
32259	81744		32304	81914		32346	61623		32394	G63809	
32260	61595		32305	61612		32346	81893		32395	G63837	
32260	81833		32305	81913		32347	58803		32399	G55821	
32262	81270		32306	61616		32347	61643		32400	77949	
32263	81726		32306	81929		32347	81922		32401	61710	
32264	58638		32314	81318		32348	58930		32401	61716	
32264	61565		32315	G63720		32348	61675		32401	81931	
32265	61687		32316	61560		32348	81930		32402	61712	
32266	61565		32316	81904		32350	61663		32402	61714	
32266R	61543		32317	69675		32350	81925		32403	81934	

**Important Note:** Competitive Interchanges are to be used for stocking purposes only. Where multiple crosses are identified, please reference the applications section of this catalog. / **Remarque importante:** Les interchanges concurrentiels ne s'utilisent qu'aux fins de stocks. Dans le cas de rferences multiples, consulter la section des applications du catalogue. / **Nota importante:** Dans le cas de rferences multiples, consulter la section des applications du catalogue. / **Nota importante:** Se pueden usar intercambios competitivos para propósitos de almacenamiento solamente. Cuando se identifican intercambios múltiples, consulte la sección de aplicaciones de este catálogo.

**COMPETITIVE & O.E.M. INTERCHANGE LIST**  
**Lista de Intercambios contra Competidores y Equipo Original.**  
**Liste dinterchange de produits comptitifs & dquipement original (OEM)**

**Monroe... cont'd**

Monroe	Gabriel	Upgrade	Monroe	Gabriel	Upgrade	Monroe	Gabriel	Upgrade	Monroe	Gabriel	Upgrade
32404	81935		33193	G64040		34677	61643		34761	61646	
32405	61720		33194	70010		34678	61642		34761	G63623	
32406	61734		33195	69589		34678	81873		34763	58638	
32407	61715		33196	G51874		34684	58807		34763	61565	
32545	82032		33197	69575		34684	G63622		34763	61687	
32592	82032		33198	69592		34685	58808		34763MM	61565	
33033	61525		33274	61704		34685	61654		34766	61664	
33033	81039		33274	69909		34685	77808		34768	83209	89414
33049	61592		33275	81937		34685	G63808		34768	89414	
33049	81340		34501	58803		34686	58809		34769	61676	
33049	81495		34501	61643		34686	61655		34770	61713	
33049	81937		34504	58817		34686	G63809		34771	81342	
33049	82034		34504	61663		34687	58810		34774	61512	
33049	82066		34514	G63958		34687	61656		34776	61599	
33049	82155		34515	61691		34687	61682		34777	58662	
33049	G63610		34515	61692		34687	G63810		34777	61600	
33050	82602		34516	81932		34689	61641		34777MM	61600	
33053	82069		34517	G63837		34689	61663		34778	61634	
33053	82126		34518	G63809		34690	61642		34780	81560	
33059	81076		34519	G63837		34690	81921		34781	61642	
33059	82104		34520	G63958		34692	58930		34782	61635	
33074	61516		34521	61710		34692	61675		34782	77674	
33074	81113		34521	61716		34693	61675		34785	61512	
33076	58357		34522	61712		34694	58930		34786	61658	
33076	61517		34522	61714		34694	61642		34787	G63615	
33082	81492		34523	77967		34694	61675		34788	G63616	
33082	81514		34523	G63969		34694	81930		34789	61658	
33084	61524		34524	77968		34721	83103		34790	61601	
33084	81164		34524	77969		34722	83400		34791	G63692	
33086	61522		34525	61680		34729	61520		34793	61520	
33086	81496		34526	61682		34729	61546		34793MM	61520	
33090	82010		34530	61685		34729	G63414		34794	61523	
33101	82010		34534	G64009		34729MM	61520		34796	58929	
33121	81880		34612	83017		34730	61520		34796	61591	
33122	81481		34617	83019		34730	G63386		34796	G63929	
33123	69675		34655	58714		34730MM	61520		34797	61547	
33123	81446		34655	61611		34731	61547		34798	58609	
33127	81446		34655	G63714		34731	61554		34798	58901	
33127	81713		34656	61638		34732	61614		34798	61542	
33128	81495		34656	G63778		34732	G63455		34798	77609	
33136	81495		34656MM	61638		34736	61525		34799	61542	
33137	81794		34657	61613		34740	58423		34800	G64043	
33178	G63884		34657	G63716		34740	61531		34802	83216	
33179	G63879		34657MM	61613		34740	81516		34802MM	83216	
33180	61662		34658	61612		34741	61544		34803	61500	
33181	61506		34671	61614		34750	58359		34803	G63306	
33182	61662		34672	61614		34750	61523		34803MM	61500	
33183	69587		34673	61638		34751	61590		34804	61623	
33184	61717		34673	81892		34751	G63607		34804	77678	
33185	G51807		34674	81913		34756	61543		34804	81893	
33187	69900		34675	61641		34759	61595		34807	61638	
33188	69473		34675MM	61641		34759	G63624		34810	G64148	
33189	69590		34676	58662		34760	58622		34811	G64121	
33190	G64042		34676	61600		34760	61591		34812	G64121	
33191	G63844		34676MM	61600		34760	G63622		34814	G63673	
33192	61704		34677	58803		34761	58623		34817	61525	

**Important Note:** Competitive Interchanges are to be used for stocking purposes only. Where multiple crosses are identified, please reference the applications section of this catalog. / **Remarque importante:** Les interchanges concurrentiels ne s'utilisent qu'aux fins de stocks. Dans le cas de rferences multiples, consulter la section des applications du catalogue. / **Nota importante:** Dans le cas de rferences multiples, consulter la section des applications du catalogue. / **Nota importante:** Se pueden usar intercambios competitivos para propósitos de almacenamiento solamente. Cuando se identifican intercambios múltiples, consulte la sección de aplicaciones de este catálogo.

**COMPETITIVE & O.E.M. INTERCHANGE LIST**  
**Lista de Intercambios contra Competidores y Equipo Original.**  
**Liste dinterchange de produits comptitifs & dquipement original (OEM)**

**Monroe... cont'd**

Monroe	Gabriel	Upgrade	Monroe	Gabriel	Upgrade	Monroe	Gabriel	Upgrade	Monroe	Gabriel	Upgrade
34817	G63355		34985	61543		37068	G63905		37120	G63511	
34821	61547		37011	G63414		37070	G63799		37121	G63490	
34822	G63306		37013	77525		37072	61529		37122	G63678	
34824	61524		37013	G63525		37073	G63419		37122ST	G63678	
34828	G63510		37014	77524		37073	G63907		37123	G63690	
34831	61523		37014	G63524		37073ST	G63907		37125	G63489	
34839	58357		37015	G63614		37074	G63620		37128	58622	
34839	61517		37015ST	G63614		37077	77909		37128	58929	
34853	61632		37016	G63635		37077ST	G63909		37128	G63929	
34895	83207	89407	37018	G63614		37078	77907		37129	G63421	
34895	89407		37019	58421		37080	G63624		37130	G63609	
34900	61521		37019	61504		37081	61535		37130	G63818	
34900	G63386		37019	81750		37081ST	G63424		37131	G63714	
34901	G63387		37021	58422		37082	G63683		37132	G63778	
34904	G63299		37022	G63495		37083	61535		37133	77716	
34905	61500		37022	G63611		37083	81548		37133	G63716	
34905	G63405		37022ST	G63611		37085	G63896		37134	G63715	
34905MM	61500		37024	G63610		37086	77638		37135	G63722	
34906	61521		37026	G63424		37087	G63638		371358	G57092	
34907	G63511		37026	G63721		37089	G63350		371358	G57118	
34910	61516		37027	61536		37090	G63357		37137	G63915	
34910	61522		37027	77425		37091	G63413		37138	G63403	
34910	81496		37028	G63904		37093	G63359		37140	G63403	
34911	61518		37029	G63419		37094	G63353		37144	61614	
34911	G63350		37029	G63492		37095	G63410		37145	G63717	
34912	G63625		37029	G63928		37095	G63414		371453	G57349	
34919	G63411		37030	77479		37096	G63359		371454	G57350	
34920	58412		37031	G63404		37097	G63950		37146	G55821	
34920	61642		37032	77494		37098	G63299		37147	G63778	
34927	61554		37033	G63548		37099	58423		37148	G63715	
34927	G63409		37034	G63414		37100	G63904		37149	G63783	
34928	61546		37035	77607		37102	G63661		37149ST	G63783	
34929	58403		37035	G63607		37103	G63413		37150	58662	
34929	G63403		37036	G63410		37103	G63662		37150	61600	
34930	61530		37037	G63409		37104	G63673		37150	77662	
34934	61528		37038	G63461		37104	G63674		37150	81873	
34944	61516		37039	G63461		37105	G63662		37151	G63803	
34945	58421		37040	G63347		37108	G63707		37151ST	G63803	
34945	61504		37041	77662		37108ST	G63707		37152	G63675	
34945	81750		37044	G63488		37109	G63708		37152ST	G63675	
34953	61509		37045	G63183		37109ST	G63708		37153	77772	
34953	81541		37047	G63813		37110	G63676		37153	G63772	
34953MM	61509		37047	G63902		371102	G57647		37154	G63717	
34958	61519		37048	G63492		37111	G63937		37155	G63676	
34959	G63432		37049	G63355		37112	G63689		37156	G63776	
34960	G63366		37050	G63489		371124	G57095		37156	G63869	
34963	61547		37051	G63490		371128L	G57206		37157	77726	
34964	61530		37053	G63386		371128R	G57206		37159	G63611	
34968	61501		37055	G63455		37113	61700		37160	G63710	
34968	61508		37062	G63818		371130	G57466		37161	G63847	
34972	G63610		37063	61555		371131	G57465		37162	G63829	
34972MM	G63610		37063	77375		371139	G57173		37163	G63783	
34975	G63511		37063	81713		37114	61699		37163	G63817	
34983	58489		37064	77454		37116	G63622		37164	G63675	
34983	61544		37065	G63426		37117	G63623		37166	G63866	
34985	58488		37066	77915		37118	G63414		371662L	G56924	

**Important Note:** Competitive Interchanges are to be used for stocking purposes only. Where multiple crosses are identified, please reference the applications section of this catalog./ **Remarque importante:** Les interchanges concurrentiels ne s'utilisent qu'aux fins de stocks. Dans le cas de rfrences multiples, consulter la section des applications du catalogue./ **Nota importante:** Dans le cas de rfrences multiples, consulter la section des applications du catalogue./ **Nota importante:** Se pueden usar intercambios competitivos para propósitos de almacenamiento solamente. Cuando se identifican intercambios múltiples, consulte la sección de aplicaciones de este catálogo.

**COMPETITIVE & O.E.M. INTERCHANGE LIST**  
**Lista de Intercambios contra Competidores y Equipo Original.**  
**Liste d'interchange de produits comptitifs & d'equipement original (OEM)**

**Monroe... cont'd**

Monroe	Gabriel	Upgrade	Monroe	Gabriel	Upgrade	Monroe	Gabriel	Upgrade	Monroe	Gabriel	Upgrade
371662R	G56925		372490	G57658		37334	G64146		471358	G57092	
37171	61662		37251	G63878		37336	G511122		471377	G57083	
37172	61506		37252	G63883		37338	G64056		471453	G57349	
37177	77678		372526	G57550		37339	G64104		471454	G57350	
37178	58803		372527	G57549		37341	G64216		471662L	G56924	
37178	61643		37253	G63875		37342	G63828		471662R	G56925	
37178	81922		372565	G57340		37352	G511122		472367	G57463	
37181	58817		372566	G57339		37358	G511038		472368	G57464	
37181	61663		372663	G57378		37361	G64163		472401	G57607	
37181	81925		372664	G57377		37361	G64186		472471L	G56924	
37183	G63832		37270	G63885		37363	G511043		472471R	G56925	
37184	G63828		37270	G64029		37367	G64063		472526	G57550	
37187	82035		37270	G64030		37370	G64050		472527	G57549	
37191	G63506		37272	70000		37377	70210		472534	G57496	
37191	G63615		372729	G57745		37379	70213		472535	G57495	
37197	G63506		37273	G64031		37803	G63306		472597	G57330	
37198	G63694		372730	G57744		39002	69996		472598	G57329	
37199	61651		37274	G64033		39004	69677		472653	G57746	
37199	69813		37275	69594		39006	69766		472654	G57747	
37202	61703		37276	69595		39020	69952		472663	G57378	
37203	G63844		37279	G63889		39021	69966		472664	G57377	
37204	G63845		37280	G64006		39027	70024		481311	G57422	
37206	G63958		37281	G64032		39040	70040		482401	G57607	
37207	58412		37282	G51798		39042	70065		482597	G57330	
37207	61692		37283	G51803		39043	70064		482598	G57329	
37208	77947		37284	G51804		39047	70033		550010	G63375	
37217	69900		37284	G51992		39050	70033		550011	69606	
37218	69909		37285	61711		39051	G64046		550016	G63424	
37219	G64049		37286	61696		39052	61777		550017	G63425	
37220	G63905		37287	61697		39102	69946		550018	69574	
372215	G57659		37288	70010		39104	G51891		550018	69575	
372216	G57658		372888	G57583		39105	61690		550019	G63918	
37225	G64027		372889	G57582		39106	G51891		550051	43140	
37226	G64028		37289	G64026		39107	70034		550061	58412	
372297	G57276		37289	G64151		39111	G511001		5504	G51807	
37231	G63720		37290	G64042		39112	G51949		551001	83125	
37232	G63506		37298	G64038		39112	G64101		551002	83122	89406
37233	G63506		37301	G511007		39113	G51746		551002	89406	
37234	G63694		37302	G64037		39114	70031		5511	70052	
372367	G57463		37307	G64071		39130	70038		5518	G51993	
372368	G57464		37308	G64052		39131	G51921		552001	G63959	
37237	69907		37309	G64080		39132	G51920		5521	69590	
37238	G63815		37310	G511004		39133	G51922		5525	G511044	
37239	77815		37313	G64056		39136	G51901		5528	G51799	
37240	G64087		37315	G64040		39138	G51921		5529	G51799	
37241	G63842		37316	70010		39139	G51920		5530	G511078	
37242	61717		37317	G51884		400295	G56887		553002	G56778	
37243	G63610		37318	G64047		400296	G56886		553003	G57802	
37244	G63864		37320	61500		400426	G56672		5532	G511044	
37245	61662		37320	81147		400427	G56671		5540	70207	
37246	61704		37322	70203		40046	49254		555004	G63299	
37247	G63615		37323	70078		400525	G56606		555005	G63689	
372471L	G56924		37326	G51966		400964	G55697		555010	77623	
372471R	G56925		37327	G64111		471128L	G57206		555011	83119	
37248	G63694		37328	G64050		471128R	G57206		555012	G63183	
372489	G57659		37329	G51996		471311	G57075		555019	85069	89455

**Important Note:** Competitive Interchanges are to be used for stocking purposes only. Where multiple crosses are identified, please reference the applications section of this catalog. / **Remarque importante:** Les interchanges concurrentiels ne s'utilisent qu'aux fins de stocks. Dans le cas de références multiples, consulter la section des applications du catalogue. / **Nota importante:** Dans le cas de références multiples, consulter la section des applications du catalogue. / **Nota importante:** Se pueden usar intercambios competitivos para propósitos de almacenamiento solamente. Cuando se identifican intercambios múltiples, consulte la sección de aplicaciones de este catálogo.

**COMPETITIVE & O.E.M. INTERCHANGE LIST**  
**Lista de Intercambios contra Competidores y Equipo Original.**  
**Liste dinterchange de produits comptitifs & dquipement original (OEM)**

**Monroe... cont'd**

Monroe	Gabriel	Upgrade	Monroe	Gabriel	Upgrade	Monroe	Gabriel	Upgrade	Monroe	Gabriel	Upgrade
555019	89455		5602	G51904		572598	G57329		58518	43099	
555026	83124	89407	5603	G51871		572889	G57582		58523	43162	
555026	89407		5605	70060		5751	82026		58567	43048	
555027	83124	89407	5607	70003		5753	82039		58568	43140	
555027	89407		5609	G51807		5754	69600		58574	43049	
555028	83207	89407	5611	G51799		5754	82138		58574	43060	
555028	89407		5612	70086		5756	82070		58578	43111	
555029	83144		5613	69945		5757	82060		58592	43058	
555031	77614		5614	70013		5759	82087		58595	43085	
555031	G63622		5615	70049		5760	82609		58600	43163	
555032	G63623		5616	70045		5762	82615		58601	43167	
555033	G63386		5617	70056		5765	82118		58606	43180	
555034	G63387		5618	70039		5766	82051		58610	43181	
555035	G63357		5621	70036		5777	69585		58612	43180	
555036	77403		5622	70037		5778	69590		58615	43181	
555038	77403		5624	70055		5779	69587		58617	43171	
555041	G63866		5626	70041		5780	69589		58618	43167	
555043	83400		5629	70086		5783	69593		58636	43181	
555045	G63394		5630	70052		5784	69591		58637	43181	
557001	83209	89414	5637	70089		5795	G51812		58654	43181	
557001	85013	89414	5639	70027		5796	69464		5867	69676	
557001	89414		5645	G511002		5797	70086		5867	75676	
557002	83125		5645	G511134		5799	69585		5868	69787	
557004	G63866		5645	G511135		5799	70001		5892	69714	
557005	83136		5646	70068		5801	69675		5892	69811	
557006	83136		5646	70209		5802	69604		5893	69715	
557007	83122	89406	5647	70059		5802	69724		5906	69625	
557007	85010		5647	70204		5803	81340		5928	69757	
557007	89406		5648	70096		5803	82066		5939	69795	
557008	85029		5659	70089		5804	69600		5947	69725	
557009	85007		5662	G51982		5809	82069		5955	69724	
557010	83144		5663	G51971		5809	82126		5959	69632	
557011	83160		5667	G51965		5811	82011		5960	69675	
557012	83204		5668	69587		5815	82601		5961	69606	
557012	85029		5671	70098		5818	69606		5962	69632	
557013	83127		5671	70102		5818	82155		5965	69845	
557014	83126	89430	5672	70095		5819	82004		5966	69724	
557014	89430		5672	70208		5820	69724		5967	69606	
557015	83209	89414	5673	G51990		5820	81514		5968	69898	
557015	89414		5681	70045		5820	82602		5969	61555	
557017	85029		5682	G511037		5823	81491		5969	69675	
557018	83127		5683	G51983		58241	34036		5969	81713	
557020	83123	89405	5685	70053		58253	34058		5971	69962	
557020	89405		5687	70053		5826	81270		5974	69863	
557021	85051		5697	G51983		58263	34073		5975	69901	
557022	85051		5698	G511092		5827	G511142		5980	69903	
557023	83144		5699	G511030		58270	34051		5981	69725	
557026	83127		571128L	G57206		58273	34073		5981	69863	
557027	83144		571128R	G57206		58275	34057		5982	69903	
557028	85010		571377L	G57083		5831	69624		5984	69945	
557031	85010		571377R	G57083		5840	69600		5986	69465	
557033	85900		572367	G57464		58411	43060		5987	69450	
557038	85125		572368	G57463		5845	69755		5988	69863	
557039	85959		572526	G57550		5847	69755		5989	69473	
5600	G51802		572527	G57549		5850	69622		5991	70020	
5601	70028		572597	G57330		58510	43140		5993	69575	

**Important Note:** Competitive Interchanges are to be used for stocking purposes only. Where multiple crosses are identified, please reference the applications section of this catalog./ **Remarque importante:** Les interchanges concurrentiels ne s'utilisent qu'aux fins de stocks. Dans le cas de rfrences multiples, consulter la section des applications du catalogue./ **Nota importante:** Dans le cas de rfrences multiples, consulter la section des applications du catalogue./ **Nota importante:** Se pueden usar intercambios competitivos para propósitos de almacenamiento solamente. Cuando se identifican intercambios múltiples, consulte la sección de aplicaciones de este catálogo.

**COMPETITIVE & O.E.M. INTERCHANGE LIST**  
**Lista de Intercambios contra Competidores y Equipo Original.**  
**Liste dinterchange de produits comptitifs & dquipement original (OEM)**

**Monroe... cont'd**

Monroe	Gabriel	Upgrade	Monroe	Gabriel	Upgrade	Monroe	Gabriel	Upgrade	Monroe	Gabriel	Upgrade
5994	69575		65123	85054		65180	85639		65428	85321	
5996	69420		65124	85053	89442	65181	85650		65429	85030	89440
5998	69863		65124	89442		65183	85181		65429	89440	
6025	83122	89406	65128	85031		65184	85180		65430	85712	
6025	89406		65130	85061	89450	65185	85180		65431	85909	
6026	83204		65133	85935		65186	85637		65432	85910	
63618	143058		65139	85918	89449	65400	85033	89427	65433	85910	
63619	143057		65139	89449		65400	89427		65434	85012	89413
63619	143061		65140	85918	89449	65400MOR	85033	89427	65434	89413	
63620	143058		65140	89449		65400MM	85033	89427	65434MOR	85012	89413
63621	143059		65141	85014		65400MM	89427		65435	85901	
63628	143064		65142	83131		65401	85013	89414	65436	85900	
63630	143058		65143	83163		65401	89414		65436MOR	85900	
63631	143057		65144	85928		65402	85311	89424	65439	85716	
63973	143057		65144MOR	85928		65402	89424		65440	85711	
65101	85062	89408	65145	85671		65402MOR	85311	89424	65441	85704	
65101	89408		65145	85929		65404	85310	89423	65442	85700	
65101MOR	85062	89408	65146	85648		65404	89423		65444	85311	89424
65102	85001	89410	65147	85924	89457	65404MOR	85310	89423	65444	89424	
65102	89410		65147	89457		65405	85023	89415	65444MOR	85311	89424
65102MOR	85001	89410	65147MOR	85924	89457	65405	89415		65448	85700	
65103	85320	89429	65148	85918	89449	65405MOR	85023	89415	65449	85702	
65103	89429		65148	89449		65406	85024		65451	85029	
65103MOR	85320	89429	65148MOR	85918	89449	65407	85736		65452	85733	
65103MM	85320	89429	65153	85921		65408	85319	89428	65453	85043	
65103MM	89429		65155	83175		65408	89428		65454	85030	89440
65105	85026		65156	85005	89430	65409	85003	89411	65454	89440	
65106	83124	89407	65156	89430		65409	89411		65455	85716	
65106	89407		65157	85954		65409MOR	85003	89411	65456	85376	
65107	85316	89426	65158	85954		65410	85300	89419	65457	85909	
65107	89426		65158MOR	85954		65410	89419		65458	85908	
65107MOR	85316	89426	65159	85070	89459	65411	85036	89405	65459	85043	
65108	85030	89440	65159	89459		65411	89405		65461	85059	
65108	89440		65159MOR	85070	89459	65412	83122	89406	65463	85040	
65109	85058	89431	65159MM	85070	89459	65412	89406		65464	85716	
65109	89431		65159MM	89459		65413	83136		65465	85939	
65110	85005	89430	65160	85080		65415	85046	89434	65466	85047	89435
65110	89430		65161	83136		65415	89434		65466	89435	
65110MOR	85005	89430	65162	85959		65416	85000	89436	65467	85054	
65110MM	85005	89430	65162MOR	85959		65416	89436		65468	85069	89455
65110MM	89430		65163	85954		65416MOR	85000	89436	65468	89455	
65111	85006		65164	85649		65416MM	85000	89436	65468MOR	85069	89455
65112	89402		65166	85090		65416MM	89436		65469	85708	
65113	85012	89413	65167	58944		65417	85322		65470	85708	
65113	89413		65167	G63969		65418	85906	89407	65471	85302	89420
65113MOR	85012	89413	65168	77968		65418	89407		65471	89420	
65114	85036	89405	65171	85964		65419	83389	89436	65473	85329	
65114	89405		65172	89413		65419	85000	89436	65474	85712	
65115	85027		65175	85084	89460	65419	89436		65475	85065	
65116	85329		65175	89460		65419MOR	85000	89436	65476	85736	
65116MM	85329		65175MOR	85084	89460	65420	85013	89414	65477	85702	
65118	85001	89410	65176	85084	89460	65420	89414		65478	85058	89431
65118	89410		65176	89460		65420MOR	85013	89414	65478	89431	
65119	85029		65177	85012	89413	65421	85916	89430	65479	83122	89406
65120	85010		65177	89413		65421	89430		65479	89406	
65122	85063		65179	85995		65426	85054		65480	83111	

**Important Note:** Competitive Interchanges are to be used for stocking purposes only. Where multiple crosses are identified, please reference the applications section of this catalog. / **Remarque importante:** Les interchanges concurrentiels ne s'utilisent qu'aux fins de stocks. Dans le cas de références multiples, consulter la section des applications du catalogue. / **Nota importante:** Dans le cas de referencias multiples, consultar la sección de aplicaciones del catálogo. / **Nota importante:** Se pueden usar intercambios competitivos para propósitos de almacenamiento solamente. Cuando se identifican intercambios múltiples, consulte la sección de aplicaciones de este catálogo.



**COMPETITIVE & O.E.M. INTERCHANGE LIST**  
**Lista de Intercambios contra Competidores y Equipo Original.**  
**Liste dinterchange de produits comptitifs & dquipement original (OEM)**

**Monroe... cont'd**

Monroe	Gabriel	Upgrade	Monroe	Gabriel	Upgrade	Monroe	Gabriel	Upgrade	Monroe	Gabriel	Upgrade
65481	85036	89405	65523	85937		66118	83001		66415	G63918	
65481	89405		65523M0R	85937		66120	85006		66418	85918	89449
65482	85006		65524	85936	89456	66121	83047		66418	89449	
65482M0R	85006		65524	89456		66122	83038		66419	85931	89458
65483	85978		65524M0R	85936	89456	66122M0R	83038		66419	89458	
65484	85976		65525	87015		66123	83004		66420	G64164	
65485	85972		65526	85956		66124	83040		66422	83163	
65485MM	85972		65527	85955		66125	83035		66422M0R	83163	
65486	85066	89448	65528	85069	89455	66125M0R	83035		66423	85001	89410
65486	89448		65528	89455		66126	83051		66423	89410	
65486M0R	85066	89448	65528M0R	85069	89455	6613	83123	89405	66423M0R	85001	89410
65487	85927		65530	85932	89453	6613	89405		66424	85310	89423
65488	85656		65530	89453		66131	83062		66424	89423	
65489	85331		65530M0R	85932	89453	66132	83001		66425	85920	89503
65490	85724	89443	65531	85334		66138	619501		66425	89503	
65490	89443		65532	85967		6614	83125		66426	85924	89457
65490M0R	85724	89443	65534	85343		66142	83039		66426	89457	
65492	85931	89458	65535	85954		66143	83007		66428	85033	89427
65492	89458		65536	85965		66145	83008		66428	89427	
65492M0R	85931	89458	65537	85962		66147	83009		66429	85311	89424
65493	85934		65539	85961		66147MM	83009		66429	89424	
65494	85061	89450	65540	85959		66149	83022		66430	83309	
65494M0R	85061	89450	65541	85119		6615	83120		66431	85066	89448
65495	85067	89451	65541M0R	85119		66150	83003		66431	89448	
65495	89451		65542	85102		66152	83012		66432	85319	89428
65495M0R	85067	89451	65543	85724	89443	66157	83015		66432	89428	
65497	85933	89454	65543	89443		66159	83031		66433	85918	89449
65497	89454		65547	85650		66159M0R	83031		66433	89449	
65498	85964		65548	85106		66160	83054		66434	85069	89455
65499	85963		65549	85642		66161	83054		66434	89455	
65500	85738		65552	85188		66162	83025		66435	83219	
65501	85323	89436	65554	85670		66169	83027		66436	85067	89451
65501	89436		6603	83103		66178	83023		66436	89451	
65502	85938		6604	83101		66179	83013		66438	83363	
65503	85919		6605	83613		66181	83025		66439	G64177	
65504	85072		6607	85052		66182	83005		66442	83150	
65504M0R	85072		6608	83128	89436	66189	83041		66443	83150	
65505	83147		6608	89436		66189MM	83041		66445	83135	
65505M0R	83147		6609	83635		66193	83034		66447	83180	
65506	83168		6610	85051		66196	83027		66448	85058	89431
65507	83143		66101	83042		66198	83158		66448	89431	
65508	83142		66101M0R	83042		66199	83048		66451	G64177	
65509	85079		66102	83059		66200	83066		66452	G64177	
65510	85052		66104	83021		66201	83081		66453	G64089	
65511	85939		66105	83044		66201M0R	83081		66454	83166	
65511M0R	85939		66106	83016		66204	83024		66455	83166	
65512	85938		66107	83048		66209	83040		66458	83396	
65512M0R	85938		66108	83028		66400	G63432		66486	85066	89448
65513	85338		66109	83048		66402	83157		66486	89448	
65514	89405		66111	83016		66403	83154		66502	646155	
65515	83125		66112	83017		66405	83154		66502M0R	646155	
65516	85013	89414	66113	83050		66406	85920	89503	66503	646155	
65516	89414		66114	83045		66406	89503		66504	632147	
65519	85060		66115	83045		66407	83134		66506	646155	
65521	85014		66116	83018		66412	83169		66535	85062	89408
65522	85082		66117	83019		66414	G64089		66535	89408	

**Important Note:** Competitive Interchanges are to be used for stocking purposes only. Where multiple crosses are identified, please reference the applications section of this catalog. / **Remarque importante:** Les interchanges concurrentiels ne s'utilisent qu'aux fins de stocks. Dans le cas de rfrences multiples, consulter la section des applications du catalogue. / **Nota importante:** Dans le cas de rfrences multiples, consulter la section des applications du catalogue. / **Nota importante:** Se pueden usar intercambios competitivos para propósitos de almacenamiento solamente. Cuando se identifican intercambios múltiples, consulte la sección de aplicaciones de este catálogo.

**COMPETITIVE & O.E.M. INTERCHANGE LIST**  
**Lista de Intercambios contra Competidores y Equipo Original.**  
**Liste d'interchange de produits complitifs & d'equipement original (OEM)**

**Monroe... cont'd**

Monroe	Gabriel	Upgrade	Monroe	Gabriel	Upgrade	Monroe	Gabriel	Upgrade	Monroe	Gabriel	Upgrade
6658	85009		66661	83123	89405	66861	83309		6811	89409	
66601	83114		66661	89405		66861MM	83309		6811MM	83312	89409
66602	G63610		66664	83215		66863	83314		6811MM	89409	
66603	83103		66665	83109		66868	83219		6817	G63355	
66604	83101		66666	G63671		66871	G63605		6824	G63349	
66605	83613		66668	83312	89409	66878	83221		6828	83219	
66607	85052		66668	89409		66878MOR	83221		6828MM	83219	
66608	83128	89436	66669	83111		66883	83314		6829	83103	
66608	83389	89436	66670	89402		66884	83125		6833	83126	89430
66608	89436		66671	83123	89405	66884MOR	83125		6833	89430	
66608MOR	83128	89436	66671	89405		66886	83124	89407	6839	G63357	
66609	83635		66672	83209	89414	66886	89407		6841	83216	
66610	83130		66672	89414		66886MOR	83124	89407	6860	83308	
66611	83016		66675	83515		66891	83215		6860MM	83308	
66612	83017		66677	83114		66893	83203	89436	6861	83309	
66613	83123	89405	66678	83023		66893	89436		6863	83314	
66613	89405		66679	83013		66893MOR	83203	89436	6868	G63360	
66614	83125		66680	83317		66894	83137		6878	83221	
66615	83120		66681	83025		66897	83126	89430	6886	83124	89407
66616	83018		66682	83005		66897	89430		6886	89407	
66617	83019		66683	83101		66898	83125		6891	83215	
66618	83159		66684	85007		66902	83401		6893	83203	89436
66620	83162		66686	85014		66903	83400		6893	89436	
66623	83004		66692	83120		66913	83303		6894	83209	89414
66624	83141		66693	83034		66921	83318		6894	89414	
66625	83162		66697	83164		66921MM	83318		6895	83204	
66626	85071		66699	83113		66922	83301		6897	83126	89430
66627	85045		66701	83215		66923	83456	89447	6897	89430	
66627MOR	85045		66707	83215		66923	89447		6898	83125	
66628	83136		66710	83209	89414	66924	83244		6900	G63386	
66629	83107		66710	89414		66924	83317		6901	G63387	
66630	83216		66710MOR	83209	89414	66924MM	83317		6901MM	G63387	
66631	83140		66713	83105		66956	83101		6902	83401	
66632	83006		66714	83216		66957	83225		6903	83400	
66633	83127		66714MM	83216		66966	85740		6910	G63413	
66634	83203	89436	66715	85026		66969	83126	89430	6911	G63350	
66634	89436		66717	83515		66969	89430		6913	83303	
66634MOR	83203	89436	66717	85716		6701	83215		6916	83123	89405
66636	83127		66717MM	83515		6707	83215		6916	89405	
66636MOR	83127		66719	83242		6710	83209	89414	6920	G63411	
66638	83123	89405	66720	85003	89411	6710	89414		6921	83318	
66638	89405		66720	89411		6712	85040		6921MM	83318	
66639	G63610		66721	83391		6713	83105		6922	83301	
66642	G63866		66722	83518		6714	83216		6923	83456	89447
66643	83007		66811	83312	89409	6715	85026		6923	89447	
66645	83008		66811	89409		6717	G63616		6927	G63409	
66646	83308		66813	83303		6718	85024		6945	G63421	
66647	83009		66828	83159		6719	83242		6956	83101	
66648	83112		66829	83103		6720	85003	89411	6957	83225	
66650	83003		66833	83126	89430	6720	89411		6960	G63366	
66653	83515		66833	89430		6721	83103		6969	83126	89430
66656	83110		66841	83216		672526	G57198		6969	89430	
66657	83015		66841MM	83216		672527	G57197		6994	83122	89406
66658	85009		66858	G63183		6803	G63907		6994	89406	
66659	83002		66860	83308		6803MM	G63907		70018	85303	89422
66660	85059		66860MM	83308		6811	83312	89409	70018	89422	

**Important Note:** Competitive Interchanges are to be used for stocking purposes only. Where multiple crosses are identified, please reference the applications section of this catalog. / **Remarque importante:** Les interchanges concurrentiels ne s'utilisent qu'aux fins de stocks. Dans le cas de références multiples, consulter la section des applications du catalogue. / **Nota importante:** Dans le cas de références multiples, consulter la section des applications du catalogue. / **Nota importante:** Se pueden usar intercambios competitivos para propósitos de almacenamiento solamente. Cuando se identifican intercambios múltiples, consulte la sección de aplicaciones de este catálogo.

**COMPETITIVE & O.E.M. INTERCHANGE LIST**  
**Lista de Intercambios contra Competidores y Equipo Original.**  
**Liste d'interchange de produits compititifs & d'equipement original (OEM)**

**Monroe... cont'd**

Monroe	Gabriel	Upgrade	Monroe	Gabriel	Upgrade	Monroe	Gabriel	Upgrade	Monroe	Gabriel	Upgrade
70021	85303	89422	71115	G51825		71377	G56807		71661	G55948	
70021	89422		71119	G51855		71379	G51794		71662	G55949	
70029	85308	89422	71120	G51849		71390	G51746		71669	G55856	
70029	89422		71124	G56838		71391	G52276		71670	G55948	
70034	85302	89420	71125	G56839		71398	G51723		71671	G55949	
70034	89420		71126	G51863		71404	G56540		71678	G56514	
70039	85303	89422	71128	G52131		71405	G56539		71679	G56506	
70039	89422		71130	G52118		71406	G56641		71680	G55676	
70041	85305		71131	G52117		71407	G56640		71681	G55675	
70042	85302	89420	71133	G56598		71417	G51714		71684	G56509	
70042	89420		71135	G52248		71424	G56633		71685	G56509	
70088	85307		71136	G52247		71425	G56634		71698	G55820	
70123	85716		71137	G51937		71426	G56672		71728	G56700	
70127	85006		71138	G51860		71427	G56671		71803	G55551	
70128	85006		71139	G51861		71433	G56622		71822	G56718	
70162	85716		71140	G51865		71434	G56621		71852	G55772	
70163	85302	89420	71141	G51864		71435	G56561		71857	G55591	
70163	89420		71142	G51738		71436	G56562		71858	G55591	
70164	85716		71146	G51838		71437	G55994		71875	G55774	
70166	85301		71254	G56591		71438	G55993		71951	G55999	
70300	85320	89429	71256	G55804		71441	G56688		71952	G55999	
70300	89429		71272	G51742		71442	G56687		71953	G55662	
70312	85001	89410	71281	G55825		71451	G56758		71954	G55661	
70312	89410		71292	G55910		71452	G56759		71962	G55681	
70315	85063		71293	G51087		71453	G56581		71964	G55697	
70317	89402		71304	G51097		71454	G56582		71973	G55698	
70331	85314	89425	71307	G51729		71485	G56802		72114	G56660	
70331	89425		71309	G51759		71486	G56791		72115	G56661	
70332	83314		71311	G51268		71488	G56792		72116	G52014	
70334	85316	89426	71321	G51722		71494	G56680		72117	G52013	
70334	89426		71322	G51724		71495	G56679		72122	G56655	
70397	85006		71327	G51727		71496	G56680		72135	G52113	
70402	85305		71331	G51740		71497	G56679		72136	G52112	
70642	85300	89419	71332	69586		71505	G56516		72138	G56817	
70642	89419		71334	G51742		71525	G56606		72139	G56635	
70644	85334		71340	G51700		71547	G56571		72140	G56636	
70651	85013	89414	71341	G51718		71548	G56637		72141	G56894	
70651	89414		71343	G56597		71551	G52336		72142	G56894	
70652	85030	89440	71346	G51887		71553	G56529		72143	G56799	
70652	89440		71347	G51477		71554	G56530		72144	G56800	
70663	85013	89414	71348	G51477		71565	G51267		72179	G56810	
70663	89414		71350	69998		71572	G56620		72203	G56809	
70691	85007		71351	G51077		71573	G56616		72205	G56722	
70720	85934		71352	G51077		71574	G56615		72206	G56721	
70721	83125		71353	G51850		71577	G51728		72207	G56729	
71100	G51815		71356	G51841		71580	G55892		72208	G56728	
71101	G51858		71358	G51715		71581	G52238		72209	G56774	
71102	G51766		71361	G51704		71582	G52237		72210	G56773	
71103	G51765		71362	G51703		71588	G56537		72211	G56731	
71105	G51854		71364	G51899		71589	G56538		72212	G56730	
71106	G51853		71367	G51773		71592	G55896		72213	G56735	
71109	G511055		71369	G51719		71593	G56568		72214	G56734	
71110	G511054		71370	G51729		71594	G56601		72215	G56733	
71111	G51758		71371	G51739		71599	G56565		72216	G56732	
71112	G51881		71372	G51738		71632	G56701		72217	G52027	
71113	G51767		71373	G51736		71639	G55911		72218	G52026	

**Important Note:** Competitive Interchanges are to be used for stocking purposes only. Where multiple crosses are identified, please reference the applications section of this catalog. / **Remarque importante:** Les interchanges concurrentiels ne s'utilisent qu'aux fins de stocks. Dans le cas de rfrences multiples, consulter la section des applications du catalogue. / **Nota importante:** Dans le cas de rfrences multiples, consulter la section des applications du catalogue. / **Nota importante:** Se pueden usar intercambios competitivos para propósitos de almacenamiento solamente. Cuando se identifican intercambios múltiples, consulte la sección de aplicaciones de este catálogo.

**COMPETITIVE & O.E.M. INTERCHANGE LIST**  
**Lista de Intercambios contra Competidores y Equipo Original.**  
**Liste dinterchange de produits comptitifs & dquipement original (OEM)**

**Monroe... cont'd**

Monroe	Gabriel	Upgrade	Monroe	Gabriel	Upgrade	Monroe	Gabriel	Upgrade	Monroe	Gabriel	Upgrade
72219	G56820		72304	G52162		72399	G51908		72545	G52256	
72220	G56819		72305	G52157		72400	G51852		72547	G52200	
72221	G56821		72306	G52156		72401	G51842		72548	G52199	
72222	G56822		72309	G52104		72408	G51760		72549	G56899	
72229	G52141		72310	G52103		72408	G51761		72562	G51877	
72230	G52140		72311	G56899		72408	G51947		72562	G51878	
72231	G52025		72312	G52301		72408	G51948		72563	G51892	
72236	G52108		72312	G56899		72423	G52185		72567	G51910	
72236	G56797		72313	G52143		72424	G52184		72585	G52330	
72237	G52107		72314	G52142		72433	G52250		72586	G52329	
72237	G56798		72315	G52275		72434	G52249		72587	G52437	
72240	G56672		72316	G52274		72437	G52300		72588	G52438	
72241	G56671		72321	G52116		72438	G52299		72596	G51896	
72244	G51774		72324	G51847		72443	G52261		72596	G51897	
72245	G52098		72327	G52176		72444	G52260		72597	G52246	
72248	G51760		72328	G52175		72445	G52183		72598	G52245	
72248	G51947		72331	G51863		72446	G52182		72599	G51898	
72248	G51948		72332	G52118		72471	G52244		72604	G52383	
72249	G51761		72333	G52117		72476	G52349		72605	G52382	
72250	G51814		72337	G52280		72477	G52348		72606	G52171	
72251	G51813		72338	G51916		72478	G51928		72607	G52170	
72257	G56837		72339	G52145		72480	G52298		72608	G52174	
72258	G56836		72340	G52144		72481	G52297		72609	G52173	
72261	G51859		72341	G51832		72482	G51934		72610	G52110	
72263	G52006		72342	G51833		72483	G52202		72611	G52111	
72263	G52450		72343	G52151		72484	G52201		72622	G56529	
72264	G52005		72344	G52150		72485	G52204		72623	G56530	
72264	G52449		72347	G52169		72486	G52203		72635	G52172	
72265	G52165		72348	G52168		72491	G52188		72647	G52361	
72266	G52164		72359	G52396		72492	G52187		72648	G52360	
72267	G52009		72360	G52395		72493	G52210		72659	G52153	
72268	G52008		72363	G52106		72494	G52209		72660	G52152	
72269	G56841		72363	G52108		72497	G51879		72670	G52265	
72270	G56840		72364	G52105		72506	G51926		72671	G52264	
72271	G52033		72364	G52107		72507	G51925		72678	G52375	
72272	G52032		72365	G52106		72508	G51908		72679	G52374	
72275	G52007		72365	G52108		72509	G52149		72688	G52332	
72276	G52004		72366	G52105		72510	G52148		72689	G52331	
72278	G55948		72366	G52107		72511	G51848		72692	G51919	
72281	G51806		72367	G52082		72518	G52125		72695	G51961	
72288	G56843		72368	G52081		72524	G52256		72706	G52354	
72289	G56842		72371	G56893		72525	G52255		72707	G52353	
72290	G52153		72372	G56892		72526	G52128		72708	G52440	
72290	G52283		72373	G52018		72527	G52127		72709	G52439	
72291	G52152		72374	G52017		72528	G52279		72731	G52314	
72291	G52282		72378	G52095		72529	G52278		72733	G52314	
72292	G51856		72379	G52094		72530	G52129		72734	G52314	
72295	G56887		72384	G52104		72531	G52130		72747	G51900	
72296	G56886		72385	G52103		72532	G52398		72755	G52143	
72297	G52155		72390	G52097		72533	G52399		72756	G52142	
72298	G52154		72391	G52096		72538	G51849		72763	G56735	
72299	G52159		72392	G52122		72539	G51849		72764	G56734	
72300	G52158		72393	G52121		72540	G52406		72778	G52256	
72301	G52161		72394	G51795		72541	G52254		72779	G52255	
72302	G52160		72397	G51883		72542	G52253		72780	G52131	
72303	G52163		72398	G51880		72544	G52255		72888	G52352	

**Important Note:** Competitive Interchanges are to be used for stocking purposes only. Where multiple crosses are identified, please reference the applications section of this catalog. / **Remarque importante:** Les interchanges concurrentiels ne s'utilisent qu'aux fins de stocks. Dans le cas de références multiples, consulter la section des applications du catalogue. / **Nota importante:** Se pueden usar intercambios competitivos para propósitos de almacenamiento solamente. Cuando se identifican intercambios múltiples, consulte la sección de aplicaciones de este catálogo.

**COMPETITIVE & O.E.M. INTERCHANGE LIST**  
**Lista de Intercambios contra Competidores y Equipo Original.**  
**Liste d'interchange de produits compititifs & d'equipement original (OEM)**

**Monroe... cont'd**

Monroe	Gabriel	Upgrade	Monroe	Gabriel	Upgrade	Monroe	Gabriel	Upgrade	Monroe	Gabriel	Upgrade
72889	G52351		74069	85301		74441	85339		801728	G56700	
72894	G51848		74070	85716		74442	85727		801803	G55551	
72895	G51848		74073	85320	89429	74451	85711		801822	G56718	
72896	G51848		74073	89429		74452	85740		801857	G55591	
72905	G52122		74074	85722		74453	85339		801858	G55591	
72906	G52121		74075	85712		74454	85314	89425	801875	G55774	
72917	G52258		74078	85027		74454	89425		801897	G51267	
72918	G52257		74079	85708		74454MM	85314	89425	801951	G55999	
72920	G52261		74080	85332		74454MM	89425		801952	G55999	
72921	G52260		74081	85727		74464	85318		801953	G55662	
72922	G51901		74400	85700		74465	85708		801954	G55661	
72934	G52494		74402	85711		74466	85318		801962	G55681	
72935	G52495		74402MM	85711		74467	85723		801964	G55697	
72936	G52525		74405	85300	89419	74469	85345		801973	G55698	
72937	G52524		74405	89419		74471	85736		802179	G56810	
72950	G52082		74405MM	85300	89419	74472	85303	89422	802236	G56797	
72951	G52081		74405MM	89419		74472	89422		802248	G51760	
72952	G51842		74406	85712		74473	85716		802248	G51761	
72955	G52171		74408	85702		74474	85916	89430	802275	G52007	
72956	G52170		74409	85310	89423	74474	89430		802276	G52004	
72957	G51972		74409	89423		74480	85351		872526	G57198	
72974	G56758		74412	85704		75934	G52495		872527	G57197	
72975	G56759		74412MM	85704		75935	G52494		901904	142444	
72976	G55948		74413	85700		801256	G55804		901908	142933	
72977	G55948		74414	85723		801281	G55825		901922	142530	
72980	G52106		74415	85318		801292	G55910		901933	142850	
72981	G52105		74416	85705	89447	801293	G51087		901940	142230	
72984	G511003		74416	89447		801311	G51268		901940	142419	
72991	G51898		74417	85311	89424	801340	G51700		901940	143030	
72997	G52174		74417	89424		801341	G51718		901940	143423	
72998	G52173		74418	85709		801347	G51477		901941	142251	
73029	G51916		74418MM	85709		801347	G51477		901941	142251	
73030	G51975		74420	85003	89411	801351	G51077		901942	142195	
73045	G52188		74420	89411		801352	G51077		901952	142173	
73046	G52187		74421	85708		801358	G51715		901958	142249	
73074	G52410		74421	85708		801377	G56807		901964	142245	
73075	G52411		74422	85733		801426	G56672		901965	142135	
7315	G64040		74422	85712		801427	G56671		901966	142252	
73226	G52281		74424	85308	89422	801433	G56622		901975	143277	
73264	G44461		74424	89422		801434	G56621		901975	143277	
74001	85307		74425	85724	89443	801437	G55994		901999	142852	
74003	85314	89425	74425	89443		801438	G55993		902906	142444	
74003	89425		74426	85333		801504	G56517		902923	142419	
74004	85315		74427	85308	89422	801505	G56516		902924	143492	
74006	85304		74427	89422		801525	G56606		902926	142561	
74012	85736		74429	85919		801556	G51267		902946	143320	
74024	85308	89422	74430	85340		801572	G56620		902953	142843	
74024	89422		74431	85341		801580	G55892		902954	142402	
74025	85303	89422	74432	85970		801592	G55896		902954	142843	
74025	89422		74433	85331		801616	G55901		902958	142329	
74028	85302	89420	74434	85711		801661	G55948		902968	143071	
74028	89420		74435	85736		801662	G55949		902968	143074	
74029	85308	89422	74436	85334		801669	G55856		902969	143072	
74029	89422		74438	85734		801678	G56514		902969	143073	
74039	85303	89422	74439	85728		801678	G56514		902973	142526	
74039	89422		74439	85728		801679	G56506		902984	142625	
			74439MM	85728		801680	G55676		902991	143063	
			74440	85729		801681	G55675		9039005	142569	

**Important Note:** Competitive Interchanges are to be used for stocking purposes only. Where multiple crosses are identified, please reference the applications section of this catalog. / **Remarque importante:** Les interchanges concurrentiels ne s'utilisent qu'aux fins de stocks. Dans le cas de références multiples, consulter la section des applications du catalogue. / **Nota importante:** En el caso de referencias múltiples, consultar la sección de aplicaciones del catálogo. / **Nota importante:** Se pueden usar intercambios competitivos para propósitos de almacenamiento solamente. Cuando se identifican intercambios múltiples, consulte la sección de aplicaciones de este catálogo.

**COMPETITIVE & O.E.M. INTERCHANGE LIST**  
**Lista de Intercambios contra Competidores y Equipo Original.**  
**Liste dinterchange de produits comptitifs & dquipement original (OEM)**

**Monroe... cont'd**

Monroe	Gabriel	Upgrade	Monroe	Gabriel	Upgrade	Monroe	Gabriel	Upgrade	Monroe	Gabriel	Upgrade
903902	142828		905945	143394		911034	G63410		911181	G63817	
903903	142649		905948	143089		911035	77679		911183	G63832	
903906	142650		905953	143418		911038	77461		911184	G63828	
903910	142546		905966	143369		911039	G63456		911186	77954	
903911	142547		905966	143468		911043	G63609		911187	G63961	
903918	143082		905969	143335		911044	58488		911187	G63962	
903924	143256		905980	143363		911044	61543		911188	G63848	
903926	142932		905983	143342		911044	81667		911190	G63609	
903928	142930		905985	143455		911050	58489		911192	77675	
903932	143459		906914	142937		911050	61544		911193	61635	
903954	142938		906917	143321		911050	81668		911194	G63808	
903967	142746		906918	143318		911055	77455		911195	58809	
903968	142747		906919	143353		911080	G63624		911195	61655	
903977	142755		906920	143353		911085	G63896		911195	77809	
903986	143466		906927	143319		911086	G63897		911196	77810	
903987	143465		906936	142556		911096	G63360		911198	G63673	
903991	142836		906958	143336		911099	77423		911220	G63905	
903995	143367		906959	143496		911102	77661		911221	77949	
904900	143325		906962	143415		911103	G63662		911222	77950	
904903	143191		906967	143477		911104	77673		911223	77948	
904904	143191		906968	143416		911128	77608		911226	G64028	
904905	142651		906969	143410		911131	77714		911228	G63882	
904909	142653		906970	143409		911132	G63778		911229	G63884	
904909	143380		906977	143458		911133	G63716		911230	G63879	
904912	143059		906980	143365		911134	G63715		911251	G63878	
904918	143197		906980	143422		911140	77403		911252	G63883	
904932	143204		906981	143531		911144	61614		911253	G63875	
904935	143201		906982	143412		911145	77717		911255	61684	
904954	143218		906983	143404		911149	61641		911256	61683	
904955	143209		906990	143422		911149	81920		911257	G63895	
904957	143087		906996	143390		911150	58662		911258	61718	
904973	143317		906997	143391		911150	61600		911259	G64016	
904974	143244		907923	143339		911150	81873		911260	61734	
904975	143315		907925	143325		911151	G63803		911261	G63870	
904980	143227		907932	143359		911152	58412		911262	G63867	
904984	143464		907937	143360		911152	61642		911265	61713	
904988	143194		907940	143361		911152	81921		911266	77951	
904989	143202		907943	143406		911152MM	G63675		911268	G63888	
904990	143094		907944	143357		911161	77847		911268	G63888	
905904	143305		907947	143345		911163	61641		911270	G63885	
905906	143239		907949	143344		911163	81920		911270	G64029	
905907	143323		907986	143366		911164	G63675		911270	G64030	
905908	143355		907986	143486		911166	58930		911273	G64031	
905909	143354		907990	143425		911166	61675		911274	G64033	
905910	143316		907991	143460		911166	81930		911276	69594	
905912	143281		907994	143495		911166	77953		911277	G63890	
905913	143385		908900	143564		911167	G63675		911277	G63891	
905914	143324		908910	143491		911168	G63813		911278	G64012	
905915	143341		908944	143398		911171	G63492		911279	G63889	
905916	143397		908946	143349		911172	G63492		911298	G64038	
905922	143364		908953	143089		911173	77807		911298	G64038	
905923	143419		908993	143474		911173	G63607		911300	G64043	
905930	143408		908995	143473		911174	G63607		911302	G64079	
905936	143388		909957	143201		911175	G63809		911303	G64121	
905937	143387		911021	77422		911176	77837		911304	G511000	
905944	143088		911030	G63479		911178	58803		911304	G511038	
						911178	61643		911330	G51980	
						911178	81922		911331	G63867	

**Important Note:** Competitive Interchanges are to be used for stocking purposes only. Where multiple crosses are identified, please reference the applications section of this catalog. / **Remarque importante:** Les interchanges concurrentiels ne s'utilisent qu'aux fins de stocks. Dans le cas de rferences multiples, consulter la section des applications du catalogue. / **Nota importante:** Dans le cas de rferences multiples, consulter la section des applications du catalogue. / **Nota importante:** Se pueden usar intercambios competitivos para propósitos de almacenamiento solamente. Cuando se identifican intercambios múltiples, consulte la sección de aplicaciones de este catálogo.

**COMPETITIVE & O.E.M. INTERCHANGE LIST**  
**Lista de Intercambios contra Competidores y Equipo Original.**  
**Liste d'interchange de produits compititifs & d'equipement original (OEM)**

**Monroe... cont'd**

Monroe	Gabriel	Upgrade	Monroe	Gabriel	Upgrade	Monroe	Gabriel	Upgrade	Monroe	Gabriel	Upgrade
911331	G64157		AMS65157	85954		AMS66138	619501		MA764	49218	
911332	G64079		AMS65159	85070	89459	AMS66162	83025		MA765	49226	
911334	G64157		AMS65162	85959		AMS66403	83154		MA768	49221	
911335	G64079		AMS65179	85995		AMS66424	85310	89423	MA769	49223	
911447	G64148		AMS65400	85033	89427	AMS66445	83135		MA776	49232	
911501	77803		AMS65402	85311	89424	AMS66502	646155		MA777	49178	
911502	77412		AMS65404	85310	89423	AMS66603	83103		MA779	49231	
911503	77783		AMS65405	85023	89415	AMS66605	83613		MA784	49369	
911504	77662		AMS65409	85003	89411	AMS66607	85052		MA785	49304	
911505	77803		AMS65410	85300	89419	AMS66608	83128	89436	MA789	49334	
911506	77953		AMS65411	85036	89405	AMS66613	83123	89405	MA803	49307	
911506	77975		AMS65416	85000	89436	AMS66615	83120		MA805	49203	
911507	77817		AMS65419	85000	89436	AMS66624	83141		MA812	49311	
911508	G64000		AMS65420	85013	89414	AMS66627	85045		MA815	49205	
911509	77971		AMS65431	85909		AMS66628	83136		MA817	49212	
911510	61717		AMS65434	85012	89413	AMS66634	83203	89436	MA819	49131	
911511	77609		AMS65435	85901		AMS66636	83127		MA822	49228	
911512	77488		AMS65436	85900		AMS66648	83112		MA822	49255	
911513	77489		AMS65444	85311	89424	AMS66683	83101		MA824	49230	
911514	77423		AMS65451	85029		AMS66710	83209	89414	MA828	49235	
911517	77422		AMS65459	85043		AMS66828	83159		MA829	49237	
911521	77715		AMS65468	85069	89455	AMS66833	83126	89430	MA834	49235	
911522	77847		AMS65480	83111		AMS66861	83309		MONRS55042	77951	
911523	77829		AMS65481	85036	89405	AMS66878	83221		MONRS55274	77412	
911525	77683		AMS65482	85006		AMS66884	83125		MONRS55288	77817	
911527	G64001		AMS65483	85978		AMS66886	83124	89407	MONSC2955	6828SE	
911528	77983		AMS65484	85976		AMS66891	83215		OE10881	85711	
911529	G63813		AMS65486	85066	89448	AMS66893	83203	89436	OE10882	85740	
911530	77907		AMS65487	85927		AMS66897	83126	89430	OE10883	85339	
911533	77976		AMS65489	85331		AMS66923	83456	89447	OE12425	83214	
911534	77980		AMS65490	85724	89443	AMS66924	83317		SA1930	6802SE	
911535	G64013		AMS65492	85931	89458	AMS66956	83101		SC2911	6804SE	
911536	77981		AMS65492MM	85931	89458	AMS66969	83126	89430	SC2912	6802SE	
911538	77973		AMS65493	85934		AMS74405	85300	89419	SC2913	14017	
911539	77973		AMS65494	85061	89450	AMS74439	85728		SC2913	6804SE	
911540	77978		AMS65495	85067	89451	AMS74465	85708		SC2915	6802SE	
911545	77975		AMS65499	85963		MA700	49205		SC2928	14040	
911546	77975		AMS65500	85738		MA702	49131		SC2928	6804SE	
972526	G57198		AMS65501	85323	89436	MA704	49110		SC2936	6801SE	
972527	G57197		AMS65502	85938		MA705	49105		SC2937	6801SE	
AMS65101	85062	89408	AMS65503	85919		MA706	49157		SC2953	6804SE	
AMS65102	85001	89410	AMS65504	85072		MA708	49135		SC2955	6828SE	
AMS65103	85320	89429	AMS65505	83147		MA711	49122		SC2961	6850SE	
AMS65106	83124	89407	AMS65511	85939		MA717	49152		SC2961	6854SE	
AMS65108	85030	89440	AMS65512	85938		MA719	49128		SC2961	6855SE	
AMS65118	85001	89410	AMS65519	85060		MA726	49173		SC2962	14071	
AMS65124	85053	89442	AMS65522	85082		MA730	49127		SC2963	6803SE	
AMS65128	85031		AMS65523	85937		MA733	49149		SC2963	6853SE	
AMS65140	85918	89449	AMS65528	85069	89455	MA743	49155		SC2964	6847SE	
AMS65142	83131		AMS65530	85932	89453	MA751	49131		SC2965	6856SE	
AMS65143	83163		AMS66104	83021		MA757	49106		SC2967	14072	
AMS65147	85924	89457	AMS66115	83045		MA758	49215		SC2970	14074	
AMS65148	85918	89449	AMS66122	83038		MA759	49213		SC2975	6828SE	
AMS65155	83175		AMS66126	83051		MA762	49152				

**Important Note:** Competitive Interchanges are to be used for stocking purposes only. Where multiple crosses are identified, please reference the applications section of this catalog. / **Remarque importante:** Les interchanges concurrentiels ne s'utilisent qu'aux fins de stocks. Dans le cas de références multiples, consulter la section des applications du catalogue. / **Nota importante:** En el caso de referencias múltiples, consultar la sección de aplicaciones del catálogo. / **Nota importante:** Se pueden usar intercambios competitivos para propósitos de almacenamiento solamente. Cuando se identifican intercambios múltiples, consulte la sección de aplicaciones de este catálogo.



**COMPETITIVE & O.E.M. INTERCHANGE LIST**  
**Lista de Intercambios contra Competidores y Equipo Original.**  
**Liste dinterchange de produits comptitifs & dquipement original (OEM)**

**Mor-Ryde Suspension**

Mor-ryde suspension	Gabriel	Upgrade	Mor-ryde suspension	Gabriel	Upgrade	Mor-ryde suspension	Gabriel	Upgrade	Mor-ryde suspension	Gabriel	Upgrade
U0109-006	G63866		U0109-014	83400		U0109006	G63866		U0109014	83400	
U0109-007	G63183		U0109-018	G63866		U0109007	G63183		U0109018	G63866	

**Motor Coach Industries**

Motor coach industries	Gabriel	Upgrade	Motor coach industries	Gabriel	Upgrade	Motor coach industries	Gabriel	Upgrade	Motor coach industries	Gabriel	Upgrade
01-205219	85727		12051103	85341		12J571	85733		196013	85340	
01205219	85727		12051137	85340		12J59	85700		22012067	85700	
12-05-1021	85340		12051138	85970		12L-4-170	83158		22024061	85704	
12-05-1022	85970		12051139	85341		12L-5-100	85727		22045526	85702	
12-05-1023	85341		12051142	85340		12L-5-114	85727		22052014	85702	
12-05-1101	85340		12051146	85340		12L-5-58	85728		3178157	85700	
12-05-1102	85970		12051147	85341		12L-5-67	85728		63-0127GS	85303	89422
12-05-1103	85341		12051148	85970		12L-5-69	85700		63-0127GS	89422	
12-05-1137	85340		12051150	85711		12L-5-70	85700		630127GS	85303	89422
12-05-1138	85970		12051165	85711		12L-5-71	85708		630127GS	89422	
12-05-1139	85341		12051166	85341		12L-5-72	85709		6314933	85708	
12-05-1142	85340		12051170	85340		12L-5-88	85729		654789	83158	
12-05-1146	85340		12051176	85728		12L-5-89	85729		680232	85733	
12-05-1147	85341		12051177	85729		12L-5-96	85728		680322	85704	
12-05-1148	85970		12051178	85339		12L-5-97	85728		680323	85700	
12-05-1150	85711		12051179	85727		12L-5-98	85339		680333	85708	
12-05-1165	85711		12051188	85970		12L-5-99	85339		680369	85708	
12-05-1166	85341		12051194	85339		12L4170	83158		680374	85728	
12-05-1170	85340		12051199	85729		12L5100	85727		680441	85729	
12-05-1176	85728		12051228	85711		12L5114	85727		680452	85339	
12-05-1177	85729		12051242	85728		12L558	85728		680462	85728	
12-05-1178	85339		12051243	85729		12L567	85728		680470	85713	
12-05-1179	85727		12051244	85727		12L569	85700		680482	85727	
12-05-1188	85970		12051260	85728		12L570	85700		680485	85733	
12-05-1194	85339		12051261	85729		12L571	85708		680544	85711	
12-05-1199	85729		12051262	85727		12L572	85709		680546	85339	
12-05-1228	85711		12051264	85727		12L588	85729		680602	85339	
12-05-1242	85728		12051327	85728		12L589	85729		680677	85728	
12-05-1243	85729		12051328	85729		12L596	85728		680680	85729	
12-05-1244	85727		12051329	85727		12L597	85728		680681	85727	
12-05-1260	85728		12056000	85711		12L598	85339		690029	85700	
12-05-1261	85729		12056001	85740		12L599	85339		695125	85704	
12-05-1262	85727		12056002	85339		12T-1-13	85303	89422	85729	85729	
12-05-1264	85727		12056033	85339		12T-1-13	89422		90-2587	85339	
12-05-1327	85728		12056053	85711		12T113	85303	89422	97-2201-00151	85700	
12-05-1328	85729		12056054	85740		12T113	89422		97-2210-00164	85708	
12-05-1329	85727		12056055	85339		12TA-01-013	85303	89422	97-9999-02514	85700	
12-05-6000	85711		12056068	85727		12TA-01-013	89422		97-9999-02585	85723	
12-05-6001	85740		1251G	85700		12TA01013	85303	89422	97-9999-02634	85733	
12-05-6002	85339		1251GS	85700		12TA01013	89422		97220100151	85700	
12-05-6033	85339		12B-5-1-G	85700		1497628	85711		97221000164	85708	
12-05-6053	85711		12B-5-1-GS	85700		1497835	85711		97999902514	85700	
12-05-6054	85740		12B51G	85700		1497993	85740		97999902585	85723	
12-05-6055	85339		12B51GS	85700		1498200	85740		97999902634	85733	
12-05-6068	85727		12G-5-1	85700		1498358	85339		G1011822	85702	
12-5-1-G	85700		12G51	85700		1498565	85339		G1101590	85713	
12-5-1-GS	85700		12J-5-10	85733		1509681	85339		G1101590GS	85713	
12051021	85340		12J-5-10GS	85733		1516986	85711		G1201339	85702	
12051022	85970		12J-5-71	85733		1517351	85740		G5008069	85700	
12051023	85341		12J-5-9	85700		1517716	85339		OE10086S	85702	
12051101	85340		12J510	85733		1522465	85727		OE10881	85711	
12051102	85970		12J510GS	85733		19507669	85340		OE10882	85740	

**Important Note:** Competitive Interchanges are to be used for stocking purposes only. Where multiple crosses are identified, please reference the applications section of this catalog. / **Remarque importante:** Les interchanges concurrentiels ne s'utilisent qu'aux fins de stocks. Dans le cas de références multiples, consulter la section des applications du catalogue. / **Nota importante:** Dans le cas de referencias multiples, consultar la sección de aplicaciones del catálogo. / **Nota importante:** Se pueden usar intercambios competitivos para propósitos de almacenamiento solamente. Cuando se identifican intercambios múltiples, consulte la sección de aplicaciones de este catálogo.

**COMPETITIVE & O.E.M. INTERCHANGE LIST**  
**Lista de Intercambios contra Competidores y Equipo Original.**  
**Liste dinterchange de produits comptitifs & dquipement original (OEM)**

**Motor Coach Industries... cont'd**

Motor coach industries	Gabriel	Upgrade	Motor coach industries	Gabriel	Upgrade	Motor coach industries	Gabriel	Upgrade	Motor coach industries	Gabriel	Upgrade
OE10883	85339		T14-1048	85302	89420	T14-1082	85727		T141080	85728	
T12-1208	85727		T14-1048	89420		T141045GS	85700		T141081	85729	
T121208	85727		T14-1080	85728		T141048	85302	89420	T141082	85727	
T14-1045GS	85700		T14-1081	85729		T141048	89420				

**Motorcraft**

Motorcraft	Gabriel	Upgrade	Motorcraft	Gabriel	Upgrade	Motorcraft	Gabriel	Upgrade	Motorcraft	Gabriel	Upgrade
AA-229	G63773		ASH-1205	83209	89414	ASH-24659	85181		ASH-706	G63614	
AA-450	G63773		ASH-1205	89414		ASH-24660	85180		ASH-707	G63614	
AA-456	G63772		ASH-1206	83122	89406	ASH-24667	G63676		ASH-712	69575	
AA-457	G63678		ASH-1206	89406		ASH-24676	G511001		ASH-759	G51729	
AA-483	G63837		ASH-121	G63607		ASH-24741	G51860		ASH-787	G63870	
AA-484	G63837		ASH-122	G63614		ASH-25	83309		ASH-791	G51724	
AA-485	G63837		ASH-12221	70052		ASH-252	G63929		ASH-795	G63867	
AA-486	G63607		ASH-12222	70052		ASH-257	G51703		ASH-797	G63867	
AA-494	83131		ASH-12277	69574		ASH-25822	83209	89414	ASH-820	G51723	
AA-500	G63809		ASH-1228	83209	89414	ASH-25822	89414		ASH-824	G63929	
AA-501	G63809		ASH-1228	89414		ASH-25823	83209	89414	ASH-864	G63929	
AA-502	G63614		ASH-1230	83122	89406	ASH-25823	89414		ASH-967	G51719	
AA-503	G63614		ASH-1230	89406		ASH-25824	83122	89406	ASHV-1	G63678	
AA-504	G63614		ASH-12322	G51861		ASH-25824	89406		ASHV-1000	G63608	
AA-615	83135		ASH-12326	G51861		ASH-25825	83122	89406	ASHV-1000	G63614	
AA-616	83175		ASH-12335	G51861		ASH-25825	89406		ASHV-1014	69845	
AA-617	85928		ASH-12336	G51861		ASH-26	85006		ASHV-1015	G63622	
AD1002	143318		ASH-1255	70096		ASH-2737	G51860		ASHV-1025	G63623	
AD1043	143360		ASH-1256	70096		ASH-29	83314		ASHV-1028	G63778	
AD1050	143415		ASH-132	G63614		ASH-294	83209	89414	ASHV-1031	G63692	
AD962	143318		ASH-137	83122	89406	ASH-294	89414		ASHV-1038	69675	
AS-1086	G63678		ASH-137	89406		ASH-32	83125		ASHV-1039	69898	
AS-413	G63414		ASH-163	G51724		ASH-322	77969		ASHV-1046	G63772	
AS-485G	G63622		ASH-172	G51704		ASH-324	77968		ASHV-1047	G63607	
AS-498G	G63608		ASH-224	G51704		ASH-335	G63969		ASHV-1048	G63525	
AS-500G	G63624		ASH-23406	G56838		ASH-36	85716		ASHV-1049	G63524	
AS1020G	G63386		ASH-23407	G56839		ASH-362	G63607		ASHV-1050	G63608	
AS105	69606		ASH-23415	G63969		ASH-363	G63525		ASHV-1051	G63837	
AS1055G	G63490		ASH-23454	G63614		ASH-364	G63524		ASHV-1056	G51722	
AS200	G63350		ASH-23458	G63614		ASH-365	G63772		ASHV-1056	G51723	
AS310	G63524		ASH-23460	G63714		ASH-366	G63608		ASHV-12	69962	
AS954G	G63299		ASH-23465	G511001		ASH-37	85712		ASHV-13	G63676	
ASH-1022	83209	89414	ASH-24397	G63716		ASH-38	85314	89425	ASHV-14	G63837	
ASH-1022	89414		ASH-24401	G63809		ASH-38	89425		ASHV-3	G63714	
ASH-1023	83122	89406	ASH-24402	85928		ASH-386	G63717		ASHV-4	G63716	
ASH-1023	89406		ASH-24407	G63867		ASH-387	G63809		ASHV-6	G63809	
ASH-1028	69592		ASH-24408	G63717		ASH-39	85001	89410	ASHV-7	69464	
ASH-1113	69593		ASH-24411	G63717		ASH-39	89410		ASHV-8	69465	
ASH-1121	G63873		ASH-24425	G63624		ASH-391	G63809		ASHV-864	G63929	
ASH-1129	14072		ASH-24433	G63837		ASH-394	G63614		ASHV-865	G63808	
ASH-1130	G63622		ASH-24434	G63607		ASH-397	83131		ASHV-866	G63810	
ASH-1131	G63622		ASH-24438	6828SE		ASH-398	85928		ASHV-867	G63455	
ASH-1132	G63622		ASH-24478	G56838		ASH-4	G63716		ASHV-871	G63809	
ASH-1135	G63623		ASH-24492	83175		ASH-407	G63809		ASHV-879	G63455	
ASH-1136	G63623		ASH-24495	G63870		ASH-408	G63809		ASHV-9	G63375	
ASH-1154	G63622		ASH-245	69900		ASH-487	G63867		ASHV-992	G63679	
ASH-1155	G63623		ASH-24531	G51887		ASH-51	G63773		ASHV-995	G63414	
ASH-1159	G64037		ASH-24533	G51888		ASH-678	G63717				
ASH-1160	G64037		ASH-24538	69575		ASH-684	G63623				
ASH-119	G63809		ASH-24539	69574		ASH-69	83175				
ASH-120	G63837		ASH-24548	G64111		ASH-701	G51888				

**Important Note:** Competitive Interchanges are to be used for stocking purposes only. Where multiple crosses are identified, please reference the applications section of this catalog./ **Remarque importante:** Les interchanges concurrentiels ne s'utilisent qu'aux fins de stocks. Dans le cas de rferences multiples, consulter la section des applications du catalogue./ **Nota importante:** Dans le cas de rferences multiples, consultar la section des applications du catalogue./ **Nota importante:** Se pueden usar intercambios competitivos para propósitos de almacenamiento solamente. Cuando se identifican intercambios múltiples, consulte la sección de aplicaciones de este catálogo.

**COMPETITIVE & O.E.M. INTERCHANGE LIST**  
**Lista de Intercambios contra Competidores y Equipo Original.**  
**Liste dinterchange de produits comptitifs & dquipement original (OEM)**

**Motorcraft... cont'd**

Motorcraft	Gabriel	Upgrade	Motorcraft	Gabriel	Upgrade	Motorcraft	Gabriel	Upgrade	Motorcraft	Gabriel	Upgrade
ASHV-997	G63678		AT-557	G63714		CAHL-405	85300	89419	CAT-930	G63461	
AST-115	G56517		AT-568	G63622		CAHL-405	89419		CAT-935	G63424	
AST-159	G51859		AT-579	G63809		CAHL-406	85004		CAT-936	G63425	
AST-162	G51859		AT-610	G63461		CAHL-409	85310	89423	CAT-944	G63347	
AST-177	69591		AT-611	G63461		CAHL-409	89423		CAT-945	G63421	
AST-233	G56655		AT-620	83209	89414	CAHL-417	85311	89424	CAT-948	G63909	
AST-235	G51849		AT-620	89414		CAHL-417	89424		CAT-953	G63375	
AST-236	G51849		AT-621	83122	89406	CAT-722	83400		CAT-953	G63903	
AST-260	G63929		AT-621	89406		CAT-729	G63414		CAT-955	G63454	
AST-266	G52110		AT-682	G63678		CAT-730	G63386		CAT-958	G63377	
AST-268	G52111		AT-683	G63679		CAT-731	G63409		CAT-960	G63366	
AST-284	G56836		AT-684	G63679		CAT-732	G63455		CAT-963	G63525	
AST-291	G56837		AT-685	G63679		CAT-736	G63394		CAT-964	G63456	
AST-311	G64047		AT-696	83140		CAT-740	G63423		CAT-972	G63610	
AST-369	G52129		AT-710	G63809		CAT-741	G63489		CAT-975	G63511	
AST-383	G56817		AT-713	G63614		CAT-745	G63608		CAT-976	G63490	
AST-385	G56817		AT-715	G63614		CAT-745	G63614		CAT-977	G63915	
AST-405	G52130		AT-716	G63809		CAT-750	G63359		CAT-983	G63489	
AST-422	G51897		AT-764	G63678		CAT-751	G63607		CAT-984	G63609	
AST-423	G51896		AT-765	G63772		CAT-758	G63909		CAT-984	G63818	
AST-424	G51897		AT-766	83209	89414	CAT-759	G63624		CAT-985	G63488	
AST-443	G52130		AT-766	89414		CAT-760	G63622		CAT-986	G63489	
AST-449	G56817		AT-811	83135		CAT-761	G63623		CAX-001	85307	
AST-451	G56817		AT619G	G63410		CAT-762	G63638		CAX-707	83215	
AST-472	G52399		AX-267A	83309		CAT-768	83209	89414	CAX-707	85001	89410
AST-474	G52399		AX-269A	83308		CAT-768	89414		CAX-707	89410	
AST-477	G52398		AX-269A	83312	89409	CAT-776	G63661		CAX-710	83209	89414
AST-66	G56516		AX-269A	89409		CAT-777	G63662		CAX-710	89414	
AST-867	G52352		AX-277A	83219		CAT-778	G63673		CAX-720	85003	89411
AST-867	G56841		AX-282A	85010		CAT-793	G63414		CAX-720	89411	
AST-868	G52351		AX-310	83215		CAT-802	G63419		CAX-811	83312	89409
AST-868	G56840		AX-327	G63773		CAT-803	G63306		CAX-811	89409	
AST-871	G56841		AX-332	85928		CAT-817	G63355		CAX-828	83207	89407
AST-872	G56840		AX-79A	83221		CAT-824	G63349		CAX-828	85012	89413
AST-900	G52406		AX-79A	85030	89440	CAT-828	G63494		CAX-828	89407	
AST-902	G52406		AX-79A	89440		CAT-831	G63359		CAX-828	89413	
AST-903	G52406		AX-85A	83219		CAT-832	G63353		CAX-833	83303	
AST-904	G52406		AX-97A	83122	89406	CAT-839	G63357		CAX-833	85005	89430
AST-905	G52255		AX-97A	85005	89430	CAT-853	G63183		CAX-833	89430	
AST-906	G52256		AX-97A	89406		CAT-868	G63360		CAX-841	83216	
AST-910	G52351		AX-97A	89430		CAT-895	83207	89407	CAX-860	83308	
AST-911	G52351		CAH-001	85307		CAT-895	89407		CAX-861	83309	
AST-913	G52352		CAH-001	85711		CAT-900	G63386		CAX-863	83314	
AST-914	G52352		CAH-003	83215		CAT-901	G63387		CAX-878	83221	
ASTV-25	G55681		CAH-006	85304		CAT-904	G63299		CAX-886	83207	89407
ASTV-31	G55901		CAH-012	85736		CAT-905	G63405		CAX-886	85014	
AT-110	G63387		CAH-025	85007		CAT-907	G63511		CAX-886	89407	
AT-147	G63350		CAH-028	85302	89420	CAT-910	G63413		CAX-891	83215	
AT-163G	G63622		CAH-028	89420		CAT-911	G63350		CAX-891	85314	89425
AT-164G	G63623		CAH-029	85308	89422	CAT-912	G63625		CAX-891	89425	
AT-504G	G63679		CAH-029	89422		CAT-919	G63411		CAX-893	83203	89436
AT-506G	G63679		CAH-069	83219		CAT-920	G63675		CAX-893	85000	89436
AT-507G	G63607		CAH-069	85301		CAT-926	G63410		CAX-893	85043	
AT-546	G63678		CAHL-400	85303	89422	CAT-927	G63409		CAX-893	89436	
AT-547	G63775		CAHL-400	85700		CAT-928	G63410		CAX-894	83209	89414
AT-554	85305		CAHL-400	89422		CAT-929	G63403		CAX-894	85005	89430

**Important Note:** Competitive Interchanges are to be used for stocking purposes only. Where multiple crosses are identified, please reference the applications section of this catalog. / **Remarque importante:** Les interchanges concurrentiels ne s'utilisent qu'aux fins de stocks. Dans le cas de références multiples, consulter la section des applications du catalogue. / **Nota importante:** Dans le cas de referencias multiples, consultar la sección de aplicaciones del catálogo. / **Nota importante:** Se pueden usar intercambios competitivos para propósitos de almacenamiento solamente. Cuando se identifican intercambios múltiples, consulte la sección de aplicaciones de este catálogo.

# COMPETITIVE & O.E.M. INTERCHANGE LIST

## Lista de Intercambios contra Competidores y Equipo Original.

### Liste d'interchange de produits compititifs & d'equipement original (OEM)

#### Motorcraft... cont'd

Motorcraft	Gabriel	Upgrade	Motorcraft	Gabriel	Upgrade	Motorcraft	Gabriel	Upgrade	Motorcraft	Gabriel	Upgrade
CAX-894	85013	89414	CAX-916	83123	89405	CAX-923	89447		CLT-109	G63614	
CAX-894	89414		CAX-916	85036	89405	CAX-924	83317		CLT-112	G63525	
CAX-894	89430		CAX-916	89405		CAX-957	83225		CLT-113	G63524	
CAX-898	83125		CAX-921	83318		CAX-969	83221		CLT-114	G63635	
CAX-898	85006		CAX-923	83102		CAX-969	85030	89440	CLT-116	G63902	
CAX-913	83303		CAX-923	83456	89447	CAX-969	89440		CLT-124	G63610	

#### Muncie Reclamation

Muncie reclamation	Gabriel	Upgrade	Muncie reclamation	Gabriel	Upgrade	Muncie reclamation	Gabriel	Upgrade	Muncie reclamation	Gabriel	Upgrade
665459	89447		H53-21144-004	85045		MR1763	89419		MR3306	85705	89447
665568	85051		H5320415006	85051		MR1765	85713		MR3306	89447	
665569	85045		H5321144004	85045		MR25767	85702		MR6394	85723	
680334	85709		MR1623	85700		MR2960	85702		MR6535	85708	
97-2210-00164	85708		MR1710	85713		MR2996	85704		MR6536	85722	
97221000164	85708		MR1751	85713		MR3303	85709				
H53-20415-006	85051		MR1763	85300	89419	MR3304H	85709				

#### National RV Inc.

National rv inc.	Gabriel	Upgrade	National rv inc.	Gabriel	Upgrade	National rv inc.	Gabriel	Upgrade	National rv inc.	Gabriel	Upgrade
1C34-18045-AA	83209	89414	9U9Z18125A	83122	89406	ASH-25823	83209	89414	AT-766	83209	89414
1C34-18045-AA	89414		9U9Z18125A	89406		ASH-25823	89414		AT-766	89414	
1C34-18045-JA	83209	89414	ASH-1022	83209	89414	ASH-25824	83122	89406	AT621	83122	89406
1C34-18045-JA	89414		ASH-1022	89414		ASH-25824	89406		AT621	89406	
24-153249	85125		ASH-1023	83122	89406	ASH-294	83209	89414	C800853	83207	89407
24-153256	85124		ASH-1023	89406		ASH-294	89414		C800853	89407	
24-186629	85125		ASH-1205	83209	89414	ASH1023	83122	89406	F4-BE5-A832-MO	85125	
24153249	85125		ASH-1205	89414		ASH1023	89406		F4-BE5-B492-HO	85125	
24153256	85124		ASH-1206	83122	89406	ASH1206	83122	89406	F4-BE5-F324-HO	85125	
24186629	85125		ASH-1206	89406		ASH1206	89406		F4-BE5-F325-HO	85124	
9U94-18045-AA	83209	89414	ASH-1228	83209	89414	ASH1230	83122	89406	F4BE5A832MO	85125	
9U94-18045-AA	89414		ASH-1228	89414		ASH1230	89406		F4BE5B492HO	85125	
9U94-18080-AA	83122	89406	ASH-1229	83209	89414	ASH137	83122	89406	F4BE5F324HO	85125	
9U94-18080-AA	89406		ASH-1229	89414		ASH137	89406		F4BE5F325HO	85124	
9U9418080AA	83122	89406	ASH-1230	83122	89406	ASH25824	83122	89406	W0005662	85125	
9U9418080AA	89406		ASH-1230	89406		ASH25824	89406		W0005663	85124	
9U9Z-18124-A	83209	89414	ASH-137	83122	89406	AT-620	83209	89414	W0006254	85125	
9U9Z-18124-A	89414		ASH-137	89406		AT-620	89414				
9U9Z-18125-A	83122	89406	ASH-25822	83209	89414	AT-621	83122	89406			
9U9Z-18125-A	89406		ASH-25822	89414		AT-621	89406				

#### NAVISTAR

Navistar	Gabriel	Upgrade	Navistar	Gabriel	Upgrade	Navistar	Gabriel	Upgrade	Navistar	Gabriel	Upgrade
H60665011	85967		H60675002	85979		H65992001	85955				
H60670007	83144		H60675006	85909							

#### Neoplan Bus

Neoplan bus	Gabriel	Upgrade	Neoplan bus	Gabriel	Upgrade	Neoplan bus	Gabriel	Upgrade	Neoplan bus	Gabriel	Upgrade
24-1700-106-149	83216		AA1002002	85705	89447	AC1002003	85705	89447	DZ1002002	85705	89447
24-1700-999-362	85009		AA1002002	89447		AC1002003	89447		DZ1002002	89447	
241700106149	83216		AA1002003	85705	89447	BN1002002	85009		GJ1002003	85705	89447
241700999362	85009		AA1002003	89447		BT1002011	83216		GJ1002003	89447	
25-1700-101-426	85705	89447	AA1802002	85705	89447	CI 1002003	85705	89447	MM1002002	85705	89447
25-1700-101-426	89447		AA1802002	89447		CI 1002003	89447		MM1002002	89447	
251700101426	85705	89447	AC1002002	85705	89447	CL1002003	85705	89447	MM1002003	85705	89447
251700101426	89447		AC1002002	89447		CL1002003	89447		MM1002003	89447	
680307	85705	89447	AC1002002GS	85705	89447	DT1802002	85705	89447			
680307	89447		AC1002002GS	89447		DT1802002	89447				

#### New Flyer

New flyer	Gabriel	Upgrade	New flyer	Gabriel	Upgrade	New flyer	Gabriel	Upgrade	New flyer	Gabriel	Upgrade
009863	85722		015915	85711							
015813	85708		016415	85722							

**Important Note:** Competitive Interchanges are to be used for stocking purposes only. Where multiple crosses are identified, please reference the applications section of this catalog. / **Remarque importante:** Les interchanges concurrentiels ne s'utilisent qu'aux fins de stocks. Dans le cas de rferences multiples, consulter la section des applications du catalogue. / **Nota importante:** Dans le cas de rferences multiples, consulter la section des applications du catalogue. / **Nota importante:** Se pueden usar intercambios competitivos para propósitos de almacenamiento solamente. Cuando se identifican intercambios múltiples, consulte la sección de aplicaciones de este catálogo.

**COMPETITIVE & O.E.M. INTERCHANGE LIST**  
**Lista de Intercambios contra Competidores y Equipo Original.**  
**Liste dinterchange de produits comptitifs & dquipement original (OEM)**

**New Flyer... cont'd**

New flyer	Gabriel	Upgrade	New flyer	Gabriel	Upgrade	New flyer	Gabriel	Upgrade	New flyer	Gabriel	Upgrade
064845	85711		680346	85722		68050640Y	85732		69536640Y	85732	
152959	85708		680352	85711		680671	85708		97-2210-00164	85708	
6322882	85713		68037840B	85720		690102	85711		97221000164	85708	
68027440Y	85716		68050440X	85716		69536140Y	87016				

**Newmar Corp.**

Newmar corp.	Gabriel	Upgrade	Newmar corp.	Gabriel	Upgrade	Newmar corp.	Gabriel	Upgrade	Newmar corp.	Gabriel	Upgrade
141700131809	85029		1616736000	85029		90045455	85909		ASH-25823	89414	
141700131810	83160		1616737000	83160		ASH-1229	83209	89414	ASH-25824	83122	89406
16-16736-000	85029		1616874000	83160		ASH-1229	89414		ASH-25824	89406	
16-16737-000	83160		1618103000	85900		ASH-25822	83209	89414	ASH25824	83122	89406
16-16874-000	83160		481700000490	85900		ASH-25822	89414		ASH25824	89406	
16-18103-000	85900		481700000493	85900		ASH-25823	83209	89414			

**Nexus RV**

Nexus rv	Gabriel	Upgrade	Nexus rv	Gabriel	Upgrade	Nexus rv	Gabriel	Upgrade	Nexus rv	Gabriel	Upgrade
ASH-1136	G63623		ASH-25822	83209	89414	ASH-25824	83122	89406	ASH25824	89406	
ASH-1154	G63622		ASH-25822	89414		ASH-25824	89406				
ASH-1229	83209	89414	ASH-25823	83209	89414	ASH1154	G63622				
ASH-1229	89414		ASH-25823	89414		ASH25824	83122	89406			

**Nissan**

Nissan	Gabriel	Upgrade	Nissan	Gabriel	Upgrade	Nissan	Gabriel	Upgrade	Nissan	Gabriel	Upgrade
54302-4W925	G56688		56101Z5014	83162		56110-EA825	G51766		56200-7Z285	61506	
54302-4W926	G56688		56101Z5017	83162		56110-EB025	G51766		56200-8Z425	61506	
54302-4W985	G56616		56110-01G27	G63909		56110-EG025	G51925		56200-8Z625	61506	
54302-5Z025	G52033		56110-1Z626	G63813		56110-F400A	G63902		56200-8Z825	61506	
54302-5Z026	G52033		56110-1Z627	G63813		56110-T8123	G63432		56200-8Z826	61506	
54302-7Y426	G56672		56110-1Z628	G63813		56110-T8129	G63432		56200-8Z827	61506	
54302-8J025	G56672		56110-30Z02	G63610		56110-Z5008	83114		56200-9FF0B	G63883	
54302-8J026	G57030		56110-3S526	G63909		56110-Z5011	G63610		56200-9FG0A	G63878	
54302-8J127	G56672		56110-3S527	G63813		56110-Z5014	83162		56200-9FG0B	G63878	
54302-9PB0A	G52525		56110-4S125	G63813		56110-Z5017	83162		56200-9Z825	61506	
54302-CA025	G52009		56110-7S026	G51715		56110-ZC00A	G51715		56200-EA025	69594	
54302-CA125	G52009		56110-7S125	G51715		56110-ZC025	G51715		56200-EA026	69594	
54302-CB125	G52009		56110-7S126	G51715		56110-ZC085	G51715		56200-EA027	69594	
54302-ZB125	G56672		56110-7S225	G51715		56110-ZP025	G51766		56200-EA285	69595	
54303-4W925	G56687		56110-7S226	G51715		56110T8123	G63432		56200-EA286	69595	
54303-4W926	G56687		56110-7S325	G51715		56110T8129	G63432		56200-EA287	69595	
54303-4W985	G56615		56110-7S326	G51715		56110Z5008	83114		56200-EA525	G64033	
54303-5Z025	G52032		56110-7Z025	G63813		56110Z5014	83162		56200-EA585	G64033	
54303-5Z026	G52032		56110-7Z225	G63813		56110Z5017	83162		56200-EB025	G64031	
54303-7Y426	G56671		56110-8Z425	G63813		56111-EG025	G51926		56200-FB085	G64031	
54303-8J025	G56671		56110-8Z426	G63813		56200-0B027	G63299		56200-F400A	G63907	
54303-8J026	G56671		56110-8Z427	G63813		56200-0B028	G63299		56200-ZC00A	G63875	
54303-8J127	G56671		56110-8Z428	G63813		56200-1B026	G63299		56200-ZP025	G64031	
54303-9PB0A	G52524		56110-8Z625	G63813		56200-1W225	G63712		56200-ZR00A	G63878	
54303-CA025	G52008		56110-8Z825	G63813		56200-1Z625	61506		56200-ZV50A	G63875	
54303-CA125	G52008		56110-8Z826	G63813		56200-1Z626	61506		56200-ZV60A	G63875	
54303-CB125	G52008		56110-8Z828	G63813		56200-2Z325	G63299		56200-ZZ90A	G63875	
54303-EJ026	G57031		56110-9Z325	G63813		56200-6B025	G63299		56210-10G27	G63907	
54303-ZB125	G56671		56110-9Z425	G63813		56200-7B025	G63299		56210-31U25	G51087	
54322-4U01A	142937		56110-CD027	G51814		56200-7B085	G63299		56210-31U27	G51087	
54322-CG00A	142937		56110-CD028	G51813		56200-7S023	G63875		56210-43U27	G51087	
56100-ZP02A	G51766		56110-EA025	G51765		56200-7S225	G63883		56210-5Y025	G51727	
56101-30Z02	G63610		56110-EA026	G51765		56200-7S226	G63883		56210-5Y026	G51727	
56101-Z5008	83114		56110-EA027	G51765		56200-7S325	G63878				
56101-Z5014	83162		56110-EA028	G51765		56200-7S326	G63878				
56101-Z5017	83162		56110-EA525	G51765		56200-7Z025	61506				
56101Z5008	83114		56110-EA526	G51765		56200-7Z225	61506				

**Important Note:** Competitive Interchanges are to be used for stocking purposes only. Where multiple crosses are identified, please reference the applications section of this catalog. / **Remarque importante:** Les interchanges concurrentiels ne s'utilisent qu'aux fins de stocks. Dans le cas de rferences multiples, consulter la section des applications du catalogue. / **Nota importante:** Dans le cas de rferences multiples, consulter la section des applications du catalogue. / **Nota importante:** Se pueden usar intercambios competitivos para propósitos de almacenamiento solamente. Cuando se identifican intercambios múltiples, consulte la sección de aplicaciones de este catálogo.

**COMPETITIVE & O.E.M. INTERCHANGE LIST**  
**Lista de Intercambios contra Competidores y Equipo Original.**  
**Liste dinterchange de produits complitifs & dquipement original (OEM)**

**Nissan... cont'd**

Nissan	Gabriel	Upgrade	Nissan	Gabriel	Upgrade	Nissan	Gabriel	Upgrade	Nissan	Gabriel	Upgrade
56210-5Z025	G51803		E43021-AA0C	G52171		E4C02-4W92J-NW	G56616		E6200-9FG1A	G63878	
56210-5Z026	G51803		E43021-AA0D	G52171		E4C02-7Y42J-NW	G56672		E6200-ET000	70027	
56210-6Y325	G51727		E43021-AA0F	G52171		E4C02-CA02J-NW	G52009		E6200-ET80A	70027	
56210-6Y425	G51727		E43021-AA1A	G52171		E4C02-ET81J-NW	G52095		E6200-ET81B	70027	
56210-7Y027	G51802		E43021-AA1B	G52171		E4C02-JA02J-NW	G52122		E6200-EZ71B	G63878	
56210-7Y427	G51802		E43021-AA1C	G52171		E4C02-JM00J-NW	G52174		E6200-EZ81A	G63878	
56210-CA025	G51798		E4303-1AA0B	G52170		E4C02-ZM70J-NW	G52033		E6200-ZJ60A	70027	
56210-CA026	G51798		E4303-1AA0C	G52170		E4C03-1AA0J-NW	G52170		E6200-ZL02A	G64031	
56210-CB025	G51798		E4303-1AA0D	G52170		E4C03-4W92J-NW	G56615		E6200-ZL10A	G64033	
56210-CB026	G51798		E4303-1AA0F	G52170		E4C03-7Y42J-NW	G56671		E6200-ZL40A	G64031	
56210-CB825	G51798		E4303-1AA1A	G52170		E4C03-CA02J-NW	G52008		E6200-ZL60A	G64031	
56210-Z6003	85308	89422	E4303-1AA1B	G52170		E4C03-ET81J-NW	G52094		E6200-ZN90A	70041	
56210-Z6003	89422		E4303-1AA1C	G52170		E4C03-JA02J-NW	G52121		E6200-ZP50A	G64031	
56210Z6003	85308	89422	E4303-1JA0B	G52355		E4C03-JM00J-NW	G52173		E6200-ZR00B	G63883	
56210Z6003	89422		E4303-1JA0B	G52356		E4C03-ZM70J-NW	G52032		E6200-ZR40A	G63878	
56217-61L10	142547		E4303-1JA0C	G52356		E6110-4KH4A	G51766		E6200-ZR40B	G63878	
56218-61L10	142547		E4303-1JA0J-NW	G52355		E6110-9FE0A	G51715		E6200-ZR50A	G63878	
66400	G63432		E4303-3KA0A	G52524		E6110-9FE0B	G51715		E6200-ZR51A	G63878	
E4302-1JA0C	G52355		E4303-3NA0C	G52524		E6110-9FE1B	G51715		E6200-ZS61B	G64033	
E4302-1JA0J-NW	G52356		E4303-3NF1A	G52524		E6110-9FE4A	G51715		E6200-ZV90B	70041	
E4302-3KA0A	G52525		E4303-3W485	G56615		E6110-9FE4B	G51715		E6200-ZV9XB	70041	
E4302-3W485	G56616		E4303-4BA1C	G52411		E6110-9FG0A	G51715		E6210-1AA0B	G51884	
E4302-4BA1C	G52410		E4303-4BF1C	G52411		E6110-CD02J-NW	G51814		E6210-1AA0C	G51884	
E4302-4BF1C	G52410		E4303-4W92J-NW	G56687		E6110-EB025	G51766		E6210-1AA1A	G51884	
E4302-4W92J-NW	G56688		E4303-7Y01B	G56671		E6110-ZL10A	G51765		E6210-1HKXB	G51990	
E4302-7Y01B	G56672		E4303-9DA0A	G52382		E6110-ZL40A	G51766		E6210-1TZ0A	G51884	
E4302-9DA0A	G52383		E4303-9DA0J-NW	G52382		E6110-ZL60A	G51766		E6210-1TZ0B	G51884	
E4302-9DA0J-NW	G52383		E4303-9DC0A	G52382		E6110-ZL60J	G51766		E6210-3AN0C	G51990	
E4302-9DF0C	G52383		E4303-9DF0C	G52382		E6110-ZP02A	G51766		E6210-3JA0B	G511043	
E4302-9DF0C	G52383		E4303-9N00D	G52382		E6110-ZP90A	G51766		E6210-3JV0B	G511043	
E4302-9N20D	G52383		E4303-9N20D	G52382		E6110-ZQ00C	G51715		E6210-3KA0A	G511043	
E4302-9PB0A	G52525		E4303-9PB0A	G52524		E6110-ZQ20C	G51715		E6210-3LM0B	G64146	
E4302-9PB0B	G52525		E4303-CB00J	G52008		E6110-ZR00A	G51715		E6210-3LN0A	G64146	
E4302-CB00J	G52009		E4303-CB025	G52008		E6110-ZR00B	G51715		E6210-3LN0J-NW	G64146	
E4302-CB025	G52009		E4303-CB10A	G52008		E6110-ZR01B	G51715		E6210-3SH0C	G511044	
E4302-CB10A	G52009		E4303-ET00B	G52094		E6110-ZR40A	G51715		E6210-3TA1B	G51874	
E4302-ET00B	G52095		E4303-ET02B	G52094		E6110-ZR40B	G51715		E6210-4AF0A	G511044	
E4302-ET02B	G52095		E4303-ET81A	G52094		E6110-ZR50A	G51715		E6210-4BA0C	G64050	
E4302-ET81A	G52095		E4303-ET81B	G52094		E6110-ZR51A	G51715		E6210-4BA1C	G64050	
E4302-ET81B	G52095		E4303-ET82B	G52094		E6110-ZS30A	G51765		E6210-5AA0C	G51884	
E4302-ET82B	G52095		E4303-JA01B	G52121		E6110-ZS60A	G51765		E6210-5HA0B	G64050	
E4302-JA01B	G52122		E4303-JA02A	G52121		E6110-ZZ50A	G51715		E6210-5Y025	G51727	
E4302-JA02A	G52122		E4303-JA11A	G52121		E6110-ZZ50B	G51715		E6210-9AM0A	G511044	
E4302-JA11A	G52122		E4303-JA12A	G52121		E6110-ZZ51A	G51715		E6210-9AN0A	G511044	
E4302-JA12A	G52122		E4303-JB12A	G52121		E6110-ZZ51B	G51715		E6210-9KN0A	G51990	
E4302-JB12A	G52122		E4303-JB12B	G52121		E6200-0W025	G63712		E6210-9LE0B	G51990	
E4302-JB12B	G52122		E4303-JM00A	G52173		E6200-1PA0D	G64164		E6210-9MB0A	G51990	
E4302-JM00A	G52174		E4303-ZB02B	G57031		E6200-1PA1A	G64164		E6210-9N60B	70089	
E4302-ZB02B	G57030		E4303-ZB03A	G57031		E6200-1PB0A	G64164		E6210-9N60J-NW	70089	
E4302-ZB03B	G57030		E4303-ZB03B	G56671		E6200-2W525	G63845		E6210-9NF0A	G511043	
E4302-ZB70A	G57030		E4303-ZB70A	G57031		E6200-4W000	G63845		E6210-CB800	G51798	
E4302-ZJ60A	G52095		E4303-ZJ60A	G52094		E6200-4W025	G63845		E6210-EM30C	70041	
E4302-ZM70A	G52033		E4303-ZM70A	G52032		E6200-9FF0A	G63883		E6210-JA00D	G51874	
E4302-ZX00A	G52122		E4303-ZX00A	G52121		E6200-9FF0B	G63883		E6210-JA01A	G51874	
E4302-ZX10A	G52122		E4303-ZX10A	G52121		E6200-9FG0A	G63878		E6210-JA11A	G51874	
E43021-AA0B	G52171		E4C02-1AA0J-NW	G52171		E6200-9FG0B	G63878		E6210-JA12D	G51874	

**Important Note:** Competitive Interchanges are to be used for stocking purposes only. Where multiple crosses are identified, please reference the applications section of this catalog. / **Remarque importante:** Les interchanges concurrentiels ne s'utilisent qu'aux fins de stocks. Dans le cas de rfrances multiples, consulter la section des applications du catalogue. / **Nota importante:** Dans le cas de rfrances multiples, consulter la section des applications du catalogue. / **Nota importante:** Se pueden usar intercambios competitivos para propósitos de almacenamiento solamente. Cuando se identifican intercambios múltiples, consulte la sección de aplicaciones de este catálogo.

# COMPETITIVE & O.E.M. INTERCHANGE LIST

## Lista de Intercambios contra Competidores y Equipo Original.

### Liste d'interchange de produits compétitifs & d'équipement original (OEM)

#### Nissan... cont'd

Nissan	Gabriel	Upgrade	Nissan	Gabriel	Upgrade	Nissan	Gabriel	Upgrade	Nissan	Gabriel	Upgrade
E6210-JA80B	G51874		E6A10-CD70B	G51813		E6B00-7S32J-NW	G63878		E6B10-CA02J-NW	G51798	
E6210-JM01A	G64050		E6A10-EA02J-NW	G51765		E6B00-EA02J-NW	69595		E6B10-EL00A	70041	
E6210-ZM70A	G51803		E6A10-EA82J-NW	G51766		E6B00-EA28J-NW	69594		E6B10-JA01J-NW	G51874	
E6210-ZX00A	G51874		E6A10-EG00D	G51926		E6B00-EB02J-NW	G64031		E6B10-ZM01J-NW	G64050	
E6210-ZX10A	G51874		E6A11-EG00D	G51925		E6B00-ZC01J-NW	G63875		E6B10-ZM70J-NW	G51803	
E6A10-01G2J-NW	G63909		E6B00-0W02J-NW	G63712		E6B10-10G2J-NW	G63907		E6B1M-EL00J-NW	70041	
E6A10-1Z62J-NW	G63813		E6B00-1B02J-NW	G63299		E6B10-1AA1J-NW	G51884		E6B20-EA52J-NW	G64033	
E6A10-7S32J-NW	G51715		E6B00-1Z62J-NW	G63492		E6B10-31U2J-NW	G51087		E6B20-ET00J-NW	70027	
E6A10-CD02J-NW	G51813		E6B00-4W02J-NW	G63845		E6B10-6Y42J-NW	G51727				
E6A10-CD70A	G51814		E6B00-7S22J-NW	G63883		E6B10-7Y02J-NW	G51802				

#### North American Bus Industries

North american bus industries	Gabriel	Upgrade	North american bus industries	Gabriel	Upgrade	North american bus industries	Gabriel	Upgrade	North american bus industries	Gabriel	Upgrade
4160003214700	85708		481700124382	85708							

#### Nova Bus

Nova bus	Gabriel	Upgrade	Nova bus	Gabriel	Upgrade	Nova bus	Gabriel	Upgrade	Nova bus	Gabriel	Upgrade
12J-5-10	85733		680323	85700		97220100151	85700		G1203223	85702	
12J510	85733		680326	85700		97999902514	85700		G5008070	85700	
22045526	85702		680470	85713		G1011822	85702		N22212	85700	
22052014	85702		97-2201-00151	85700		G1101590	85713		OE 10086S	85702	
680232	85733		97-9999-02514	85700		G1201339	85702				

#### Orion Bus Industries

Orion bus industries	Gabriel	Upgrade	Orion bus industries	Gabriel	Upgrade	Orion bus industries	Gabriel	Upgrade	Orion bus industries	Gabriel	Upgrade
010134501-4	85307		0501345-11	85732		060131508	87016		695343	85732	
0101345014	85307		050134501-4	85716		070131502	87016		695347	85732	
010134508-4	85732		0501345014	85716		070131506	87016		695366	85732	
0101345084	85732		0501345024	85732		070231514	85729		695389	87016	
010234503-4	85308	89422	050134506-4	85732		070231527	85729		695420	85729	
010234503-4	89422		0501345064	85732		20117501	85720		695421	87016	
0102345034	85308	89422	050134508	85732		20117504	85720		695440	85729	
0102345034	89422		050134509	85732		20117505	85720		97-9999-02635	85732	
020117503-4	85720		050134510	85732		6430645	85729		97-9999-02636	85716	
0201175034	85720		050134511	85732		680091	85303	89422	97999902635	85732	
020117504	85720		050134513	85732		680091	89422		97999902636	85716	
020273541	83203	89436	050230501	85716		680102	85712		A-4890	85712	
020273541	89436		050231501-4	85716		680274	85716		A4890	85712	
020273541-4	85000	89436	0502315014	85716		680352	85711		OB020570	85711	
020273541-4	89436		050231502-4	85716		680378	85720		OB020764	85716	
0202735414	85000	89436	0502315024	85716		680504	85716		OB3166657	85700	
0202735414	89436		050231505	85716		680506	85732				
020273544	83203	89436	050231507	85716		690102	85711				
020273544	89436		060131507	87016		695327	85732				

#### Oshkosh Motors

Oshkosh motors	Gabriel	Upgrade	Oshkosh motors	Gabriel	Upgrade	Oshkosh motors	Gabriel	Upgrade	Oshkosh motors	Gabriel	Upgrade
060670-018	83166		1573270	83207	89407	2JD137	83119		4036892	G63605	
1202-0054	83021		1573270	89407		3638112	G63183		404845	85304	
12020054	83021		1573280	83221		40-0242	83312	89409	404951	85316	89426
12405F	85734		1583470	85051		40-0242	89409		404951	89426	
12405F-1	85303	89422	1745500	89430		40-4845	85304		405348	85058	89431
12405F-1	89422		2034140	646177		40-4951	85316	89426	405348	89431	
12405F1	85303	89422	2173340	85303	89422	40-4951	89426		406967	85030	89440
12405F1	89422		2173340	89422		40-5348	85058	89431	406967	89440	
12405FX1	85303	89422	2218640	83009		40-5348	89431		5353054	85303	89422
12405FX1	89422		26228-A	83122	89406	40-6967	85030	89440	5353054	89422	
1398980	83127		26228-A	89406		40-6967	89440		5361994	85734	
1445910	85300	89419	26228A	83122	89406	400242	83312	89409	60670-018	83166	
1445910	89419		26228A	89406		400242	89409		60670018	83166	

**Important Note:** Competitive Interchanges are to be used for stocking purposes only. Where multiple crosses are identified, please reference the applications section of this catalog. / **Remarque importante:** Les interchanges concurrentiels ne s'utilisent qu'aux fins de stocks. Dans le cas de références multiples, consulter la section des applications du catalogue. / **Nota importante:** Dans le cas de références multiples, consulter la section des applications du catalogue. / **Nota importante:** Se pueden usar intercambios competitivos para propósitos de almacenamiento solamente. Cuando se identifican intercambios múltiples, consulte la sección de aplicaciones de este catálogo.



# COMPETITIVE & O.E.M. INTERCHANGE LIST

## Lista de Intercambios contra Competidores y Equipo Original.

### Liste d'interchange de produits compititifs & d'equipement original (OEM)

#### Oshkosh Motors... cont'd

Oshkosh motors	Gabriel	Upgrade	Oshkosh motors	Gabriel	Upgrade	Oshkosh motors	Gabriel	Upgrade	Oshkosh motors	Gabriel	Upgrade
651444	83221		665060	83122	89406	690049		89422	RW24285	83119	
665040	85303	89422	665060		89406	90044448		85051			
665040	89422		690049	85303	89422	P117099		83120			

#### Osterlund Truck

Osterlund truck	Gabriel	Upgrade	Osterlund truck	Gabriel	Upgrade	Osterlund truck	Gabriel	Upgrade	Osterlund truck	Gabriel	Upgrade
220-S5-10	85712		59011	83214		680117		89419			
220S510	85712		680117	85300	89419						

#### Ottawa Truck

Ottawa truck	Gabriel	Upgrade	Ottawa truck	Gabriel	Upgrade	Ottawa truck	Gabriel	Upgrade	Ottawa truck	Gabriel	Upgrade
53540451	85300	89419	680117	85300	89419	90013787		89423	9007342		89422
53540451	89419		680117	89419		90027577		85720			
59011	83214		90013787	85310	89423	9007342		85303	89422		

#### PACCAR

Paccar	Gabriel	Upgrade	Paccar	Gabriel	Upgrade	Paccar	Gabriel	Upgrade	Paccar	Gabriel	Upgrade
03-04176PLUS-2	85308	89422	665633	85033	89427	671656-2		85985			
08849AE	85989		665633	89427		C71-1014PLUS		85936	89456		

#### Pacific Truck & Trailer

Pacific truck & trailer	Gabriel	Upgrade	Pacific truck & trailer	Gabriel	Upgrade	Pacific truck & trailer	Gabriel	Upgrade	Pacific truck & trailer	Gabriel	Upgrade
507202C1	85030	89440	507202C1		89440						

#### Page Suspension

Page suspension	Gabriel	Upgrade	Page suspension	Gabriel	Upgrade	Page suspension	Gabriel	Upgrade	Page suspension	Gabriel	Upgrade
1080099	83203	89436	1081933	83204		665133		89436	A-2212		85029
1080099	89436		665133	83203	89436	665267		85029	A2212		85029

#### PAI Corp.

Pai corp.	Gabriel	Upgrade	Pai corp.	Gabriel	Upgrade	Pai corp.	Gabriel	Upgrade	Pai corp.	Gabriel	Upgrade
HSA-5067	85305		HSA-5095	83215		HSA5080		83221			
HSA-5080	83221		HSA5067	85305		HSA5095		83215			

#### Peerless Trailer

Peerless trailer	Gabriel	Upgrade	Peerless trailer	Gabriel	Upgrade	Peerless trailer	Gabriel	Upgrade	Peerless trailer	Gabriel	Upgrade
120-1	83125		1201	83125		72-61		83125	7261		83125

#### Peterbilt

Peterbilt	Gabriel	Upgrade	Peterbilt	Gabriel	Upgrade	Peterbilt	Gabriel	Upgrade	Peterbilt	Gabriel	Upgrade	
02-00376	85302	89420	02-02737		89408	02-02741		85012	89413	0202061	85013	89414
02-00376	89420		02-02737-2	85062	89408	02-02741		89413		0202061		89414
02-00495	85302	89420	02-02737-2	89408		02-02741-2		85012	89413	0202142	85036	89405
02-00495	89420		02-02737PLUS	85062	89408	02-02741-2		89413		0202142		89405
02-01759	83312	89409	02-02737PLUS	89408		02-02742		85062	89408	0202225	85012	89413
02-01759	89409		02-02737PLUS-2	85062	89408	02-02742		89408		0202225		89413
02-01787	85062	89408	02-02737PLUS-2	89408		02-02742-2		85062	89408	0202736	85302	89420
02-01787	89408		02-02738	85012	89413	02-02742-2		89408		0202736		89420
02-01890	85012	89413	02-02738	89413		02-03020		85910		02027362	85302	89420
02-01890	89413		02-02738-2	85012	89413	02-04010		85012	89413	02027362		89420
02-02061	85013	89414	02-02738-2	89413		02-04010		89413		0202736PLUS	85302	89420
02-02061	89414		02-02738PLUS	85012	89413	02-04010-2		85012	89413	0202736PLUS		89420
02-02142	85036	89405	02-02738PLUS	89413		02-04010-2		89413		0202736PLUS2	85302	89420
02-02142	89405		02-02738PLUS-2	85012	89413	02-0739PLUS-2		85013	89414	0202736PLUS2		89420
02-02225	85012	89413	02-02738PLUS-2	89413		02-0739PLUS-2		89414		0202736PLUS2	89420	
02-02225	89413		02-02739	85013	89414	0200376		85302	89420	0202737	85062	89408
02-02736	85302	89420	02-02739	89414		0200376		89420		0202737		89408
02-02736	89420		02-02739-2	85013	89414	0200495		85302	89420	02027372	85062	89408
02-02736-2	85302	89420	02-02739-2	89414		0200495		89420		02027372		89408
02-02736-2	89420		02-02739PLUS	85013	89414	0201759		83312	89409	0202737PLUS	85062	89408
02-02736PLUS	85302	89420	02-02739PLUS	89414		0201759		89409		0202737PLUS		89408
02-02736PLUS	89420		02-02740	85036	89405	0201787		85062	89408	0202737PLUS2	85062	89408
02-02736PLUS-2	85302	89420	02-02740	89405		0201787		89408				
02-02736PLUS-2	89420		02-02740-2	85036	89405	0201890		85012	89413			
02-02737	85062	89408	02-02740-2	89405		0201890		89413				

**Important Note:** Competitive Interchanges are to be used for stocking purposes only. Where multiple crosses are identified, please reference the applications section of this catalog. / **Remarque importante:** Les interchanges concurrentiels ne s'utilisent qu'aux fins de stocks. Dans le cas de références multiples, consulter la section des applications du catalogue. / **Nota importante:** Dans le cas de referencias multiples, consultar la sección de aplicaciones del catálogo. / **Nota importante:** Se pueden usar intercambios competitivos para propósitos de almacenamiento solamente. Cuando se identifican intercambios múltiples, consulte la sección de aplicaciones de este catálogo.

**COMPETITIVE & O.E.M. INTERCHANGE LIST**  
**Lista de Intercambios contra Competidores y Equipo Original.**  
**Liste dinterchange de produits comptitifs & dquipement original (OEM)**

**Peterbilt... cont'd**

Peterbilt	Gabriel	Upgrade	Peterbilt	Gabriel	Upgrade	Peterbilt	Gabriel	Upgrade	Peterbilt	Gabriel	Upgrade
0202737PLUS2	89408		03-07421	89424		03074232	89427		16-13947-000PLUS-2	89428	
0202738	85012	89413	03-07421PLUS	85311	89424	0307423PLUS	85033	89427	1613947000PLUS	85319	89428
0202738	89413		03-07421PLUS	89424		0307423PLUS	89427		1613947000PLUS	89428	
02027382	85012	89413	03-07421PLUS-2	85311	89424	0307423PLUS2	85033	89427	1613947000PLUS2	85319	89428
02027382	89413		03-07421PLUS-2	89424		0307423PLUS2	89427		1613947000PLUS2	89428	
0202738PLUS	85012	89413	03-07421SPL	85311	89424	0307424	85311	89424	16725-01	83126	89430
0202738PLUS	89413		03-07421SPL	89424		0307424	89424		16725-01	89430	
0202738PLUS2	85012	89413	03-07423	85033	89427	0307424PLUS	85311	89424	1672501	83126	89430
0202738PLUS2	89413		03-07423	89427		0307424PLUS	89424		1672501	89430	
0202739	85013	89414	03-07423-2	85033	89427	0308350	85343		1707378PAC	85182	
0202739	89414		03-07423-2	89427		03083502	85343		19495-01	83126	89430
02027392	85013	89414	03-07423PLUS	85033	89427	0308781	85069	89455	19495-01	89430	
02027392	89414		03-07423PLUS	89427		0308781	89455		1949501	83126	89430
0202739PLUS	85013	89414	03-07423PLUS-2	85033	89427	03087812	85069	89455	1949501	89430	
0202739PLUS	89414		03-07423PLUS-2	89427		03087812	89455		20-16755	83042	
0202740	85036	89405	03-07424	85311	89424	10-12032-002PLUS	85320	89429	2016755	83042	
0202740	89405		03-07424	89424		10-12032-002PLUS	89429		2016755	83042	
02027402	85036	89405	03-07424PLUS	85311	89424	10-12032-002PLUS-2	85320	89429	2018987C1PLUS	85003	89411
02027402	89405		03-07424PLUS	89424		10-12032-002PLUS-2	89429		2018987C1PLUS	89411	
0202741	85012	89413	03-08350	85343		10-12032-002PLUS-2	89429		2018987C1PLUS-2	85003	89411
0202741	89413		03-08350-2	85343		10-12542-000PLUS	85901		2018987C1PLUS-2	89411	
02027412	85012	89413	03-08781	85069	89455	1012032002PLUS	85320	89429	2018987C1PLUS2	85003	89411
02027412	89413		03-08781	89455		1012032002PLUS	89429		2018987C1PLUS2	89411	
0202742	85062	89408	03-08781-2	85069	89455	1012032002PLUS2	85320	89429	23-08233	85308	89422
0202742	89408		03-08781-2	89455		1012032002PLUS2	89429		23-08233	89422	
02027422	85062	89408	0301635	85308	89422	1012542000PLUS	85901		23-10393	85308	89422
02027422	89408		0301635	89422		11418	646177		23-10393	89422	
0203020	85910		0304176	85308	89422	11418WAC	646177		23-12262	85012	89413
0204010	85012	89413	0304176	89422		1201-0012	83023		23-12262	89413	
0204010	89413		0304176PLUS	85308	89422	1201-0054	83021		2308233	85308	89422
02040102	85012	89413	0304176PLUS	89422		1201-8001	83908		2308233	89422	
02040102	89413		0304629	85311	89424	1201-8002	83081		2310393	85308	89422
020739PLUS2	85013	89414	0304629	89424		1201-8006	83081		2310393	89422	
020739PLUS2	89414		0305106	85033	89427	12010012	83023		2312262	85012	89413
03-01635	85308	89422	0305106	89427		12010054	83021		2312262	89413	
03-01635	89422		0305384	85033	89427	12018001	83908		25523002	83908	
03-04176	85308	89422	0305384	89427		12018002	83081		25523024	83081	
03-04176	89422		0306084	85033	89427	12018006	83081		29-02455	83008	
03-04176PLUS	85308	89422	0306084	89427		1202-0012	83023		29-06005	83035	
03-04176PLUS	89422		0306084PLUS	85033	89427	1202-0032	83016		29-06032	83035	
03-04176PLUS-2	85308	89422	0306084PLUS	89427		1202-0054	83021		2902455	83008	
03-04629	85311	89424	0306084PLUS2	85033	89427	1202-1044	83025		2906005	83035	
03-04629	89424		0306084PLUS2	89427		12020012	83023		2906032	83035	
03-05106	85033	89427	0307281	85311	89424	12020032	83016		471700004420	85109	
03-05106	89427		0307281	89424		12020054	83021		471700004423	85109	
03-05384	85033	89427	0307421	85311	89424	12021044	83025		471700013186	85109	
03-05384	89427		0307421	89424		12887-01	85013	89414	47902-13PLUS	83122	89406
03-06084	85033	89427	0307421PLUS	85311	89424	12887-01	89414		47902-13PLUS	89406	
03-06084	89427		0307421PLUS	89424		12887-02	85013	89414	47902-13PLUS-2	83122	89406
03-06084PLUS	85033	89427	0307421PLUS2	85311	89424	12887-02	89414		47902-13PLUS-2	89406	
03-06084PLUS	89427		0307421PLUS2	89424		1288701	85013	89414	4790213PLUS	83122	89406
03-06084PLUS-2	85033	89427	0307421SPL	85311	89424	1288701	89414		4790213PLUS	89406	
03-06084PLUS-2	89427		0307421SPL	89424		1288702	85013	89414	60670-005PLUS	83137	
03-07281	85311	89424	0307423	85033	89427	1288702	89414		60670-005PLUS-2	83137	
03-07281	89424		0307423	89427		16-13947-000PLUS	85319	89428	60670-008	83123	89405
03-07421	85311	89424	03074232	85033	89427	16-13947-000PLUS	89428		60670-008	89405	
						16-13947-000PLUS-2	85319	89428	60670-008L	83123	89405

**Important Note:** Competitive Interchanges are to be used for stocking purposes only. Where multiple crosses are identified, please reference the applications section of this catalog. / **Remarque importante:** Les interchanges concurrentiels ne s'utilisent qu'aux fins de stocks. Dans le cas de rferences multiples, consulter la section des applications du catalogue. / **Nota importante:** Dans le cas de rferences multiples, consulter la section des applications du catalogue. / **Nota importante:** Se pueden usar intercambios competitivos para propósitos de almacenamiento solamente. Cuando se identifican intercambios múltiples, consulte la sección de aplicaciones de este catálogo.

**COMPETITIVE & O.E.M. INTERCHANGE LIST**  
**Lista de Intercambios contra Competidores y Equipo Original.**  
**Liste dinterchange de produits comptitifs & dquipement original (OEM)**

**Peterbilt... cont'd**

Peterbilt	Gabriel	Upgrade	Peterbilt	Gabriel	Upgrade	Peterbilt	Gabriel	Upgrade	Peterbilt	Gabriel	Upgrade
60670-008L	89405		665762	85012	89413	671963	85937		90044025PLUS	89414	
60670-008PLUS	83123	89405	665762	89413		680026	85302	89420	90044089PLUS	83124	89407
60670-008PLUS	89405		665783	83123	89405	680026	89420		90044089PLUS	89407	
60670-008PLUS-2	83123	89405	665783	89405		680027	85308	89422	90044089PLUS-2	83124	89407
60670-008PLUS-2	89405		665784	83122	89406	680027	89422		90044089PLUS-2	89407	
60670005PLUS	83137		665784	89406		680185	85308	89422	90045132	85909	
60670008	83123	89405	665785	83137		680185	89422		90045605	85109	
60670008	89405		665788	85000	89436	680237	85303	89422	90045803	85109	
60670008L	83123	89405	665788	89436		680237	89422		90045812	85109	
60670008L	89405		665788-2	85000	89436	680239	85310	89423	96027-1054	83011	
60670008PLUS	83123	89405	665788-2	89436		680239	89423		960271054	83011	
60670008PLUS	89405		665826	85069	89455	680240	85302	89420	ACHB966	83136	
60680-003	83112		665826	89455		680240	89420		B71-1000	85031	
60680-003L	83112		665844	85069	89455	680241	85311	89424	B71-1001	85070	89459
60680-004	83143		665844	89455		680241	89424		B71-1001	89459	
60680-004L	83143		665858	85070	89459	680242	85308	89422	B71-1002	85001	89410
60680-005	83142		665858	89459		680242	89422		B71-1002	89410	
60680-005L	83142		665858-2	85070	89459	680253	85314	89425	B71-1003	83312	89409
60680003	83112		665858-2	89459		680253	89425		B71-1003	89409	
60680003L	83112		6658582	85070	89459	680261	85062	89408	B71-6000	85959	
60680004	83143		6658582	89459		680261	89408		B71-6000-2	85959	
60680004L	83143		665876	85959		680261-2	85062	89408	B71-6002	85012	89413
60680005	83142		665918	85900		680261-2	89408		B71-6002	89413	
60680005L	83142		665926	85047	89435	6802612	85062	89408	B71-6002-2	85012	89413
654782	83008		665926	89435		6802612	89408		B71-6002-2	89413	
654812	83042		665927	85901		680279	83209	89414	B71-6003	85029	
654919	83035		665928	85062	89408	680279	89414		B71-6003-2	85029	
665133	83203	89436	665928	89408		680280	85906	89407	B71-6004	85084	89460
665133	89436		665930	85001	89410	680280	89407		B71-6004	89460	
665174	85060		665930	89410		680281	85003	89411	B71-6005	85084	89460
665565PLUS	85007		665931	83312	89409	680281	89411		B71-6005	89460	
665565PLUS-2	85007		665931	89409		680303	85007		B71-6006	85084	89460
665565PLUS2	85007		665932	85012	89413	680348	85012	89413	B71-6006	89460	
665617	85031		665932	89413		680348	89413		B71-6007	85062	89408
665617-2	85031		665945	85902		680425	85320	89429	B71-6007	89408	
6656172	85031		665945-2	85902		680425	89429		B71-6008	83312	89409
665632	85013	89414	665950	85902		680435	85033	89427	B71-6008	89409	
665632	89414		671052	85070	89459	680435	89427		B71-6009	83219	
665633	85033	89427	671052	89459		680457	85302	89420	B71-6009	85062	89408
665633	89427		671052-2	85070	89459	680457	89420		B71-6009	89408	
665655	85062	89408	671052-2	89459		680459	85311	89424	B71-6010	85023	89415
665655	89408		6710522	85070	89459	680459	89424		B71-6010	89415	
665656	85012	89413	6710522	89459		680473	85319	89428	B71-6011	85062	89408
665656	89413		671091	85069	89455	680473	89428		B71-6011	89408	
665657	85013	89414	671091	89455		680586	85311	89424	B71-6012	85119	
665657	89414		671092	85012	89413	680586	89424		B71-6013	85012	89413
665658	85036	89405	671092	89413		70701PLUS	85900		B71-6013	89413	
665658	89405		671654	85936	89456	800670	85060		B71-6015	85012	89413
665660	85033	89427	671654	89456		8086053PLUS	85047	89435	B71-6015	89413	
665660	89427		671699	85937		8086053PLUS	89435		B71-6016	85012	89413
665662	85012	89413	671794	85067	89451	85013AOC	85013	89414	B71-6016	89413	
665662	89413		671794	89451		85013AOC	89414		B71-6016A	85012	89413
665738	85910		671962PLUS	85936	89456	85013ac0	85013	89414	B71-6016A	89413	
665738-2	85910		671962PLUS	89456		85013ac0	89414		B71-6017	85910	
665752	85067	89451	671962SPL	85936	89456	90044011	85004		B71-6018	85012	89413
665752	89451		671962SPL	89456		90044025PLUS	83209	89414	B71-6018	89413	

**Important Note:** Competitive Interchanges are to be used for stocking purposes only. Where multiple crosses are identified, please reference the applications section of this catalog. / **Remarque importante:** Les interchanges concurrentiels ne s'utilisent qu'aux fins de stocks. Dans le cas de références multiples, consulter la section des applications du catalogue. / **Nota importante:** En el caso de referencias múltiples, consultar la sección de aplicaciones del catálogo. / **Nota importante:** Se pueden usar intercambios competitivos para propósitos de almacenamiento solamente. Cuando se identifican intercambios múltiples, consulte la sección de aplicaciones de este catálogo.

# COMPETITIVE & O.E.M. INTERCHANGE LIST

## Lista de Intercambios contra Competidores y Equipo Original.

### Liste d'interchange de produits compétitifs & d'équipement original (OEM)

#### Peterbilt... cont'd

Peterbilt	Gabriel	Upgrade	Peterbilt	Gabriel	Upgrade	Peterbilt	Gabriel	Upgrade	Peterbilt	Gabriel	Upgrade
B71-6019	85989		B716017	85910		C711002	85067	89451	K374-27-2	89410	
B71-6020	85989		B716018	85012	89413	C711002	89451		K374-28PLUS	85314	89425
B711000	85031		B716018	89413		C7110022	85067	89451	K374-28PLUS	89425	
B711001	85070	89459	B716019	85989		C7110022	89451		K374-29PLUS	85310	89423
B711001	89459		B716020	85989		C711002PLUS	85067	89451	K374-29PLUS	89423	
B711002	85001	89410	BFRG 072	85182		C711002PLUS	89451		K374-33-2	83312	89409
B711002	89410		C71-1002	85067	89451	C711002PLUS2	85067	89451	K374-33-2	89409	
B711003	83312	89409	C71-1002	89451		C711002PLUS2	89451		K374-33PLUS	83312	89409
B711003	89409		C71-1002-2	85067	89451	C711011	85069	89455	K374-33PLUS	89409	
B716000	85959		C71-1002-2	89451		C711011	89455		K374-33PLUS-2	83312	89409
B716002	85012	89413	C71-1002PLUS	85067	89451	C711011PLUS	85069	89455	K374-33PLUS-2	89409	
B716002	89413		C71-1002PLUS	89451		C711011PLUS	89455		K374102	83215	
B7160022	85012	89413	C71-1002PLUS-2	85067	89451	C711011PLUS2	85069	89455	K37426PLUS	85001	89410
B7160022	89413		C71-1002PLUS-2	89451		C711011PLUS2	89455		K37426PLUS	89410	
B716003	85029		C71-1011	85069	89455	C711011SPL	85069	89455	K37426PLUS2	85001	89410
B716004	85084	89460	C71-1011	89455		C711011SPL	89455		K37426PLUS2	89410	
B716004	89460		C71-1011PLUS	85069	89455	C711013	85985		K374272	85001	89410
B716005	85084	89460	C71-1011PLUS	89455		C711014	85936	89456	K374272	89410	
B716005	89460		C71-1011PLUS-2	85069	89455	C711014	89456		K37428PLUS	85314	89425
B716006	85084	89460	C71-1011PLUS-2	89455		C711016	85067	89451	K37428PLUS	89425	
B716006	89460		C71-1011SPL	85069	89455	C711016	89451		K37429PLUS	85310	89423
B716007	85062	89408	C71-1011SPL	89455		C711017	85069	89455	K37429PLUS	89423	
B716007	89408		C71-1013	85985		C711017	89455		K37433PLUS	83312	89409
B716008	83312	89409	C71-1014	85936	89456	C716000	85067	89451	K37433PLUS	89409	
B716008	89409		C71-1014	89456		C716000	89451		PP1058870	83059	
B716009	83219		C71-1016	85067	89451	C7160002	85067	89451	PP2582870	83012	
B716009	85062	89408	C71-1016	89451		C7160002	89451		R71-1004	83049	
B716009	89408		C71-1017	85069	89455	C716002	85311	89424	R71-1005	83024	
B716010	85023	89415	C71-1017	89455		C716002	89424		R71-6005	83042	
B716010	89415		C71-6000	85067	89451	C716003	85988		R71-6007	83008	
B716011	85062	89408	C71-6000	89451		C716004	85343		R71-6008	83035	
B716011	89408		C71-6000-2	85067	89451	C716005	85069	89455	R71-6009	83081	
B716012	85119		C71-6000-2	89451		C716005	89455		R711004	83049	
B716013	85012	89413	C71-6002	85311	89424	C716015	85067	89451	R711005	83024	
B716013	89413		C71-6002	89424		C716015	89451		R716005	83042	
B716015	85012	89413	C71-6003	85988		K374-10-2	83215		R716007	83008	
B716015	89413		C71-6004	85343		K374-26PLUS	85001	89410	R716008	83035	
B716016	85012	89413	C71-6005	85069	89455	K374-26PLUS	89410		R716009	83081	
B716016	89413		C71-6005	89455		K374-26PLUS-2	85001	89410	TK19679	83126	89430
B716016A	85012	89413	C71-6015	85067	89451	K374-26PLUS-2	89410		TK19679	89430	
B716016A	89413		C71-6015	89451		K374-27-2	85001	89410			

#### Phoenix Cruiser RV

Phoenix cruiser rv	Gabriel	Upgrade	Phoenix cruiser rv	Gabriel	Upgrade	Phoenix cruiser rv	Gabriel	Upgrade	Phoenix cruiser rv	Gabriel	Upgrade
ASH-1136	G63623		ASH-1154	G63622							

#### Pierce Manufacturing Inc.

Pierce manufacturing inc.	Gabriel	Upgrade	Pierce manufacturing inc.	Gabriel	Upgrade	Pierce manufacturing inc.	Gabriel	Upgrade	Pierce manufacturing inc.	Gabriel	Upgrade
060665-013	85965		1445910	89419		1860766000	83040		40-0242	89409	
060665-013L	85965		18-41762-000	83038		1860767000	83039		40-3089	83312	89409
060665013	85965		18-47349-000	83039		1943267	85962		40-3089	89409	
10-13592-000	85959		18-47350-000	83040		2034140	646177		40-3135	85030	89440
10-13760-000	85959		18-60764-000	83038		2509223C91	83054		40-3135	89440	
10-13809-000	85958		18-60766-000	83040		2509223C92	83054		40-4845	85304	
1013760000	85959		18-60767-000	83039		3514952C1	85976		40-4951	85316	89426
1013809000	85958		1841762000	83038		3576464C2	85957				
1201-9008	83054		1847349000	83039		3626571C2	85072				
12019008	83054		1847350000	83040		3868265C1	85995				
1445910	85300	89419	1860764000	83038		40-0242	83312	89409			

**Important Note:** Competitive Interchanges are to be used for stocking purposes only. Where multiple crosses are identified, please reference the applications section of this catalog. / **Remarque importante:** Les interchanges concurrentiels ne s'utilisent qu'aux fins de stocks. Dans le cas de références multiples, consulter la section des applications du catalogue. / **Nota importante:** Dans le cas de referencias multiples, consultar la sección de aplicaciones del catálogo. / **Nota importante:** Se pueden usar intercambios competitivos para propósitos de almacenamiento solamente. Cuando se identifican intercambios múltiples, consulte la sección de aplicaciones de este catálogo.

**COMPETITIVE & O.E.M. INTERCHANGE LIST**  
**Lista de Intercambios contra Competidores y Equipo Original.**  
**Liste dinterchange de produits comptitifs & dquipement original (OEM)**

**Pierce Manufacturing Inc.... cont'd**

Pierce manufacturing inc.	Gabriel	Upgrade	Pierce manufacturing inc.	Gabriel	Upgrade	Pierce manufacturing inc.	Gabriel	Upgrade	Pierce manufacturing inc.	Gabriel	Upgrade
40-4951	89426		471700002991	85959		60680-005	83142		ASH-85927	77986	
40-5348	85058	89431	471700003920	85958		60680-005L	83142		ASH-866127	77986	
40-5348	89431		60657-003	85072		60680004	83143		ASH-866139	77986	
40-6967	85030	89440	60657-003L	85072		60680004L	83143		H60657003	85072	
40-6967	89440		60657003	85072		60680005	83142		H60675-003	85976	
400242	83312	89409	60657003L	85072		60680005L	83142		H60675003	85976	
400242	89409		60665-013	85965		6127088C1	83163		HC3Z-18125-EP	77986	
404845	85304		60665-013L	85965		6127713C2	85656		HC3Z-18125-X	77986	
404951	85316	89426	60665013	85965		6127714C1	85928		HDR60680-005	83142	
404951	89426		60675-003	85976		680401	85307		HDR60680005	83142	
405348	85058	89431	60675-003L	85976		814903003482	83040		LC3Z-18125-J	77986	
405348	89431		60675003	85976		814903003483	83039		LC3Z-18125-W	77986	
406967	85030	89440	60675003L	85976		814903003528	83038		SD-15165	85304	
406967	89440		60680-004	83143		9HE302	85919		SDA471700002991	85959	
471700000440	85959		60680-004L	83143		ASH-85789	77986				

**Powerhouse Coach Inc.**

Powerhouse coach inc.	Gabriel	Upgrade	Powerhouse coach inc.	Gabriel	Upgrade	Powerhouse coach inc.	Gabriel	Upgrade	Powerhouse coach inc.	Gabriel	Upgrade
141700005838	85061	89450	20551628	89448		471700000443	89448		64838-003	89454	
20433424	85061	89450	20973993	85061	89450	471700003830	85933	89454	64838-003L	85933	89454
20485632	85933	89454	21137330	85933	89454	471700003830	89454		64838-003L	89454	
20485632	89454		21137330	89454		471700003832	85933	89454	64838003	85933	89454
20485633	85933	89454	21436086	85061	89450	471700003832	89454		64838003	89454	
20485633	89454		21462380	85088		471700006040	85088		64838003L	85933	89454
20551628	85066	89448	471700000443	85066	89448	64838-003	85933	89454	64838003L	89454	

**Powerpacker**

Powerpacker	Gabriel	Upgrade	Powerpacker	Gabriel	Upgrade	Powerpacker	Gabriel	Upgrade	Powerpacker	Gabriel	Upgrade
PP1058870	83059										

**Prevost**

Prevost	Gabriel	Upgrade	Prevost	Gabriel	Upgrade	Prevost	Gabriel	Upgrade	Prevost	Gabriel	Upgrade
01-0100-905	85303	89422	19501669	85339		481700999390	85736		631013	85329	
01-0100-905	89422		19502711	85702		52001	85708		650407	85736	
010100905	85303	89422	19506846	85339		63-1013	85329		680323	85700	
010100905	89422		19507669	85340		630001	85713		680422	85329	
0822045526	85702		196013	85340		630080	85713		680492	85713	
12L-5-89	85729		196533	85708		630091	85736		690060	85713	
12L589	85729		3166657	85700		630103	85329		74939852	85308	89422
12T-1-13	85303	89422	481700000207	85329		630127	85736		74939852	89422	
12T-1-13	89422		481700000209	85713		630134	85329		G1011822	85702	
12T113	85303	89422	481700000210	85329		630161	85736		G5008070	85700	
12T113	89422		481700000210	85713		630234	85329		N22212	85700	
19501288	85729		481700999376	85329		630236	85329				
19501289	85728		481700999380	85329		630252	85329				
19501547	85740		481700999386	85736		630253	85713				

**ProPar**

ProPar	Gabriel	Upgrade	ProPar	Gabriel	Upgrade	ProPar	Gabriel	Upgrade	ProPar	Gabriel	Upgrade
PROSH646155	646155		PROSH85003	89411		PROSH85062	85062	89408	PROSH85321	85321	
PROSH83027	83027		PROSH85005	85005	89430	PROSH85062	89408		PROSH85322	85322	
PROSH83042	83042		PROSH85005	89430		PROSH85069	85069	89455	PROSH85323	85323	89436
PROSH83122	83122	89406	PROSH85006	85006		PROSH85069	89455		PROSH85323	89436	
PROSH83122	89406		PROSH85012	85012	89413	PROSH85070	85070	89459	PROSH85338	85338	
PROSH83125	83125		PROSH85012	89413		PROSH85070	89459		PROSH85919	85919	
PROSH83127	83127		PROSH85030	85030	89440	PROSH85310	85310	89423	PROSH85923	85923	89458
PROSH83128	83128	89436	PROSH85030	89440		PROSH85310	89423		PROSH85923	89458	
PROSH83128	89436		PROSH85045	85045		PROSH85311	85311	89424			
PROSH83130	83130		PROSH85052	85052		PROSH85311	89424				
PROSH85000	85000	89436	PROSH85053	85053	89442	PROSH85316	85316	89426			
PROSH85000	89436		PROSH85053	89442		PROSH85316	89426				

**Important Note:** Competitive Interchanges are to be used for stocking purposes only. Where multiple crosses are identified, please reference the applications section of this catalog. / **Remarque importante:** Les interchanges concurrentiels ne s'utilisent qu'aux fins de stocks. Dans le cas de rferences multiples, consulter la section des applications du catalogue. / **Nota importante:** Dans le cas de rferences multiples, consulter la section des aplicaciones du catalogue. / **Nota importante:** Se pueden usar intercambios competitivos para propósitos de almacenamiento solamente. Cuando se identifican intercambios múltiples, consulte la sección de aplicaciones de este catálogo.

**COMPETITIVE & O.E.M. INTERCHANGE LIST**  
**Lista de Intercambios contra Competidores y Equipo Original.**  
**Liste dinterchange de produits comptitifs & dquipement original (OEM)**

**ProPar... cont'd**

ProPar	Gabriel	Upgrade	ProPar	Gabriel	Upgrade	ProPar	Gabriel	Upgrade	ProPar	Gabriel	Upgrade
PROSH85924	85924	89457	PROSH85932	85932	89453	PROSH85936	85936	89456	PROSH85954	85954	
PROSH85924	89457		PROSH85932	89453		PROSH85936	89456		PROSH89437	89437	

**PRT (ADD)**

Prt (add)	Gabriel	Upgrade	Prt (add)	Gabriel	Upgrade	Prt (add)	Gabriel	Upgrade	Prt (add)	Gabriel	Upgrade
141251	G52174		170740	81076		173293	81446		173617	61546	
170129	85303	89422	170996	81270		173296	82125		173618	61625	
170129	85320	89429	171295	83137		173328	70000		173619	61664	
170129	89422		171376	81924		173436	61659		173619	81869	
170129	89429		171384	81096		173436	61777		173620	61676	
170130	85001	89410	171430	82126		173436	81924		173620	81926	
170130	89410		172127	61651		173471	69591		173621	61635	
170132	85724	89443	172127	69813		173493	G64111		173621	61714	
170132	89443		172131	61606		173504	61544		173622	61599	
170133	85060		172131	G51077		173504	61555		173622	81928	
170133	85959		172174	69585		173504	61685		173623	61638	
170139	85003	89411	172174	70001		173504	81668		173623	81892	
170139	89411		172193	61560		173504	81713		173624	61613	
170140	85014		172193	81904		173505	61543		173624	81914	
170146	83207	89407	172289	81495		173505	61565		173625	61641	
170146	89407		172293	G63845		173505	81667		173625	81920	
170148	83456	89447	172321	69587		173506	61601		173626	61654	
170148	89447		172331	61592		173506	81836		173627	61656	
170198	81744		172331	81937		173509	61504		173627	61682	
170207	81510		172358	61651		173509	61601		173628	61626	
170211	85058	89431	172358	69813		173509	81516		173628	81916	
170211	89431		172359	61651		173509	81750		173650	G64027	
170213	85054		172359	69813		173509	81836		173651	G64028	
170215	85918	89449	172371	69676		173510	61512		173655	61528	
170215	85920	89503	172371	81481		173510	61542		173655	81482	
170215	89449		172372	69464		173510	61555		173656	61662	
170215	89503		172372	81935		173510	81559		173680	81091	
170217	83163		172373	69473		173510	81713		173681	81484	
170221	85921		172404	69606		173510	81726		173682	81691	
170222	83175		172404	81495		173523	61535		173684	81559	
170225	83136		172405	61717		173523	81548		173686	G63387	
170228	G63969		172412	G51077		173542	61536		173687	81744	
170237	83136		172413	69589		173542	81549		173688	61704	
170243	85069	89455	172436	G64052		173564	69900		173688	69909	
170243	89455		172452	61690		173575	61655		173690	61591	
170245	83122	89406	172453	G63872		173579	61623		173690	81744	
170245	89406		172461	70027		173579	81893		173691	61595	
170246	83123	89405	172480	G51807		173581	61591		173691	81833	
170246	89405		172704	69606		173581	81744		173692	61703	
170247	85006		172704	81495		173582	61646		173693	61658	
170248	83137		173001	61506		173582	81828		173693	81923	
170248	85976		173001	81318		173583	61626		173694	61643	
170249	85927		173070	82156		173583	61627		173694	81922	
170257	G64177		173098	61508		173583	81917		173695	81930	
170262	83159		173098	81507		173584	61542		173696	61641	
170263	85071		173099	81494		173584	61555		173696	61663	
170264	83515		173170	61605		173584	81726		173696	81920	
170296	69755		173170	81878		173585	61611		173696	81921	
170335	G63717		173176	61506		173585	81912		173696	81922	
170366	61529		173176	81318		173586	61600		173696	81925	
170464	81492		173196	G63720		173586	81873		173697	61642	
170469	G63809		173228	61500		173616	81496		173697	61675	

**Important Note:** Competitive Interchanges are to be used for stocking purposes only. Where multiple crosses are identified, please reference the applications section of this catalog. / **Remarque importante:** Les interchanges concurrentiels ne s'utilisent qu'aux fins de stocks. Dans le cas de références multiples, consulter la section des applications du catalogue. / **Nota importante:** Dans le cas de références multiples, consulter la section des applications du catalogue. / **Nota importante:** Se pueden usar intercambios competitivos para propósitos de almacenamiento solamente. Cuando se identifican intercambios múltiples, consulte la sección de aplicaciones de este catálogo.

**COMPETITIVE & O.E.M. INTERCHANGE LIST**  
**Lista de Intercambios contra Competidores y Equipo Original.**  
**Liste dinterchange de produits comptitifs & dquipement original (OEM)**

**PRT (ADD)... cont'd**

Prt (add)	Gabriel	Upgrade	Prt (add)	Gabriel	Upgrade	Prt (add)	Gabriel	Upgrade	Prt (add)	Gabriel	Upgrade
173697	81921		173821	G63918		173932	G64079		175452	61690	
173697	81930		173823	61712		173933	61713		175454	69595	
173698	61642		173823	81933		173934	G64071		175456	69594	
173698	61675		173824	61675		173935	G51980		175457	G64031	
173698	61691		173824	81930		173935	G64042		175458	61675	
173698	61692		173825	61714		173936	G51812		175458	81930	
173698	81921		173826	61641		173937	G64050		177083	61605	
173698	81930		173826	61663		173938	G64104		177083	81878	
173698	81931		173826	81920		173939	G64043		177085	61675	
173700	69898		173826	81925		173941	70078		177085	81930	
173700	81794		173827	G63870		173942	69590		190008	70095	
173701	61615		173828	G63867		173943	G64111		190008	70102	
173701	81936		173828	G64157		173944	G64121		192404	69606	
173704	61614		173830	61700		173945	G64042		192404	81495	
173705	61658		173831	G51850		173946	70010		192409	61734	
173705	81923		173831	G63879		173961	G64163		192411	61720	
173708	61500		173831	G63882		173962	70203		193206	61608	
173708	81147		173832	61565		173985	82128		193208	G63707	
173725	61679		173833	G63889		174044	G63306		193574	69901	
173727	61593		173839	61643		174072	61531		193575	61655	
173727	81872		173839	61683		174072	81516		193576	G63726	
173728	81911		173839	81922		174072	81750		193577	61565	
173729	61616		173840	G63844		174088	81484		193577	61687	
173729	81929		173841	61684		174244	61523		193580	61624	
173730	69675		173841	61685		174244	81096		193580	81890	
173730	81446		173842	G64032		174283	61643		193581	61591	
173731	61510		173843	G51812		174283	81922		193581	81744	
173731	81871		173851	G63873		174303	61523		193582	61646	
173733	69962		173857	G63918		174303	81096		193582	81828	
173735	61565		173858	61704		174315	81710		193583	81891	
173735	61687		173859	61680		174340	81582		193598	70098	
173736	61522		173860	61685		174386	G64033		193598	70208	
173736	81496		173862	61777		174408	G63404		193655	61528	
173738	81091		173863	61654		174441	61642		193655	81482	
173739	81164		173886	61662		174441	81921		193657	61539	
173741	61629		173887	69587		174442	81922		193695	61675	
173741	81918		173888	81507		174546	61715		193695	81930	
173766	69962		173889	G64026		174575	61638		193697	61675	
173769	61634		173890	G64048		174575	81892		193698	81921	
173769	81919		173892	61711		174576	61612		193702	G63782	
173800	81932		173893	70060		174576	81913		193703	G63781	
173802	61692		173894	61687		175075	81039		193706	G63809	
173802	61710		173895	81676		175093	81730		193707	G63815	
173802	61716		173896	G64037		175357	61642		193724	81318	
173803	G63884		173898	69592		175357	81921		193805	G63815	
173804	G63879		173898	69593		175366	G63832		193818	G63837	
173804	G63882		173899	G64087		175367	G63828		193819	61663	
173806	G63885		173900	70039		175404	G63864		193820	G64000	
173806	G64029		173901	61696		175407	G63883		193834	G63607	
173806	G64030		173901	61697		175408	G63878		194267	61642	
173813	G64087		173903	61655		175409	61718		194267	81921	
173814	G64006		173904	G64080		175441	61710		194432	81667	
173815	61612		173912	69591		175442	G63875		194506	61676	
173815	81913		173913	82602		175448	61682		194506	81926	
173816	G51802		173924	G511001		175449	61713		194510	69575	
173817	G51814		173928	G64040		175450	81744		194511	G63625	

**Important Note:** Competitive Interchanges are to be used for stocking purposes only. Where multiple crosses are identified, please reference the applications section of this catalog./ **Remarque importante:** Les interchanges concurrentiels ne s'utilisent qu'aux fins de stocks. Dans le cas de rfrences multiples, consulter la section des applications du catalogue./ **Nota importante:** Dans le cas de rfrences multiples, consulter la section des applications du catalogue./ **Nota importante:** Se pueden usar intercambios competitivos para propósitos de almacenamiento solamente. Cuando se identifican intercambios múltiples, consulte la sección de aplicaciones de este catálogo.



**COMPETITIVE & O.E.M. INTERCHANGE LIST**  
**Lista de Intercambios contra Competidores y Equipo Original.**  
**Liste dinterchange de produits comptitifs & dquipement original (OEM)**

**PRT (ADD)... cont'd**

Prt (add)	Gabriel	Upgrade	Prt (add)	Gabriel	Upgrade	Prt (add)	Gabriel	Upgrade	Prt (add)	Gabriel	Upgrade
194539	69574		372364	70052		373313	70089		375033	G51861	
194539	69575		372366	G51905		373314	G51884		375034	G51864	
194564	81869		372370	70055		373315	G511055		375037	G51865	
194574	69575		372382	70056		373316	G511054		375038	G51865	
194580	G51904		372387	G51759		373317	G51848		390107	70052	
343162	G51804		373111	G51714		373318	G51863		392226	70033	
349058	G51077		373123	G55825		373319	70059		392226	70038	
349076	G51887		373124	G51767		373319	70204		392352	G51746	
349122	G64046		373139	G51881		373320	70053		392383	G511001	
370018	G64148		373142	G51700		373330	G51799		392393	G511001	
370087	G51920		373150	G55821		373333	G51825		393171	G51477	
370088	G51921		373162	G51804		373348	G51856		393338	G51922	
370100	70041		373192	G56597		373352	69420		394058	G51077	
370126	G51879		373193	G51738		373358	G511002		394075	G51887	
370439	69966		373194	69907		373358	G511134		394076	G51888	
370480	G51738		373195	G51858		373367	G511122		394091	G51477	
370504	G511043		373198	G51739		373368	G511122		414649	G56735	
370523	G51848		373201	G51799		373373	G51933		414909	G56733	
370716	70052		373201	G56899		373374	G64049		470110	G55910	
370796	70065		373202	G51983		373376	G51961		470401	G52248	
370797	G51937		373204	G51850		373380	G51898		470402	G52247	
370816	82011		373206	G51798		373382	G51972		470405	G52163	
371019	69946		373207	G51803		373385	G511044		470406	G52162	
371090	69450		373213	G51783		373386	G64216		470407	G52332	
371176	81934		373223	G51842		373804	G51850		470408	G52331	
371231	G51965		373227	G51736		374067	G51704		470409	G52204	
371305	G511092		373231	G56598		374070	G51719		470410	G52203	
372046	G56591		373238	G51805		374070	G51860		470411	G52118	
372060	69945		373242	G51716		374071	G51729		470412	G52117	
372095	69945		373244	G511004		374074	G51723		470427	G52131	
372095	81934		373247	G51849		374078	G51703		470455	G51774	
372161	G51727		373248	G64038		374085	G51849		470465	G52183	
372184	G51795		373250	G51721		374086	G51849		470466	G52182	
372221	69863		373251	G51883		374090	G51477		470467	G52103	
372236	70040		373253	G52037		374091	G51477		470468	G52104	
372237	70020		373254	G52036		374110	G56838		470470	G52103	
372288	70036		373255	70045		374111	G56839		470475	G52210	
372291	70003		373256	70013		374112	G51937		470476	G52209	
372294	G51794		373257	G51880		374113	G51855		470489	G52176	
372295	G51794		373259	G51854		374116	69998		470490	G52175	
372298	69586		373260	G51853		374117	G51742		470767	G52103	
372304	70028		373269	G51879		374126	G51861		471045	G51097	
372313	70055		373271	70034		374128	G51900		471055	G55999	
372316	70036		373276	70037		374130	G51916		471056	G55999	
372320	G51971		373278	G51898		374130	G51975		471288	G55772	
372333	70041		373280	70086		375007	69998		471385	G52161	
372336	G51807		373284	G51898		375022	G51724		471386	G52160	
372337	G51838		373288	70089		375023	G51722		472057	G56540	
372340	G51908		373289	G51898		375024	G51715		472058	G56539	
372345	G51727		373297	G51993		375027	G51928		472079	G52354	
372349	69465		373301	G51832		375028	G51870		472080	G52353	
372350	G51910		373303	G51966		375028	G51891		472101	G51859	
372351	G51908		373305	G51833		375028	G51949		472102	G51859	
372360	70056		373307	70037		375030	G51765		472119	G511003	
372361	G51852		373308	G51847		375031	G51766		473003	G56514	
372362	G51841		373312	G64056		375032	G51860		473004	G56506	

**Important Note:** Competitive Interchanges are to be used for stocking purposes only. Where multiple crosses are identified, please reference the applications section of this catalog. / **Remarque importante:** Les interchanges concurrentiels ne s'utilisent qu'aux fins de stocks. Dans le cas de rferences multiples, consulter la section des applications du catalogue. / **Nota importante:** Dans le cas de rferences multiples, consulter la section des applications du catalogue. / **Nota importante:** Se pueden usar intercambios competitivos para propósitos de almacenamiento solamente. Cuando se identifican intercambios múltiples, consulte la sección de aplicaciones de este catálogo.

**COMPETITIVE & O.E.M. INTERCHANGE LIST**  
**Lista de Intercambios contra Competidores y Equipo Original.**  
**Liste d'interchange de produits compititifs & d'equipement original (OEM)**

**PRT (ADD)... cont'd**

Prt (add)	Gabriel	Upgrade	Prt (add)	Gabriel	Upgrade	Prt (add)	Gabriel	Upgrade	Prt (add)	Gabriel	Upgrade
473073	G55662		474103	G52128		474410	G52274		474850	G52237	
473074	G55661		474104	G52026		474416	G56655		474851	G52238	
473206	G51806		474104	G52127		474431	G52188		474863	G56568	
473340	G51268		474121	G56802		474432	G52187		474864	G56601	
473402	G56894		474133	G52165		474433	G52155		474885	G55993	
473403	G52098		474133	G52298		474433	G52188		474886	G55994	
473407	G51814		474134	G52164		474434	G52154		474887	G56635	
473408	G51813		474134	G52297		474462	G56817		474888	G56636	
473439	G56529		474135	G55676		474468	G51267		474907	G56680	
473440	G56530		474136	G55675		474480	G51097		474907	G56731	
473453	G51815		474177	G56517		474482	G51740		474908	G56679	
473454	G51806		474178	G56516		474485	G56581		474908	G56730	
473465	G51878		474209	G52106		474486	G56582		474909	G56733	
473466	G51877		474210	G52105		474513	G52006		474910	G56732	
473485	70068		474215	G52265		474514	G52005		474910	G56734	
473485	70209		474215	G56821		474517	G52155		474917	G56672	
473671	G56893		474216	G52264		474518	G52154		474918	G56671	
473672	G56892		474216	G56822		474545	G56758		474923	G56722	
473685	G51714		474241	G52106		474546	G56759		474924	G56721	
473719	G55999		474242	G52105		474547	G56660		474929	G52033	
473720	G55999		474243	G56841		474548	G56661		474930	G52032	
473761	G56887		474244	G56840		474553	G56894		474931	G52111	
473762	G56886		474247	G52246		474557	G56820		474932	G52110	
473817	G52018		474248	G52245		474558	G56819		474933	G56843	
473818	G52017		474249	G52122		474577	G52009		474934	G56842	
473821	G56529		474250	G52121		474578	G52008		474937	G52157	
473822	G56530		474251	G52174		474579	G56581		474938	G52156	
473851	G51926		474252	G52173		474580	G56582		474939	G52185	
473852	G51925		474257	G52171		474583	G52014		474940	G52184	
473859	G52095		474258	G52170		474584	G52013		474941	G52082	
473860	G52094		474261	G52246		474587	G56735		474942	G52081	
473863	G52283		474262	G52245		474588	G56734		474947	G52007	
473864	G52282		474274	G52131		474588	G56735		474948	G52004	
473879	G51859		474283	G52202		474607	G51760		474955	G52104	
473880	G51859		474284	G52201		474608	G51761		474956	G52103	
473885	G51806		474305	G52238		474617	G52108		474963	G52104	
473897	70049		474306	G52237		474617	G56797		474964	G52103	
473899	G51718		474311	G56633		474618	G52107		474969	G56810	
473901	G51911		474312	G56634		474618	G56798		474970	G56810	
473909	G51897		474317	G52300		474621	G51097		474981	G52274	
473910	G51896		474318	G52299		474635	G56729		474982	G52275	
473911	G51892		474319	G55772		474636	G56728		474989	G52097	
473911	G51919		474321	G51267		474650	G56734		474990	G52096	
473913	G51097		474323	G55856		474653	G56773		474991	G56809	
473915	G51815		474354	G55896		474654	G56774		474992	G56809	
473919	G52153		474363	G52261		474659	G52141		475033	G52314	
473920	G52152		474364	G52260		474660	G52140		475034	G52314	
473925	G56887		474368	G51728		474704	G51758		475071	G56537	
473926	G56886		474381	G55892		474705	G51758		475071	G56538	
473935	G51980		474385	G52108		474729	G55697		475071	G56633	
473944	G64121		474386	G52107		474743	G56622		475072	G56538	
474008	G52025		474397	G55901		474744	G56621		475072	G56634	
474008	G55948		474399	G55901		474772	G56802		475077	G55681	
474015	G52244		474403	G55698		474776	G56606		475078	G56509	
474015	G55949		474407	G56620		474805	G56641		475084	G56807	
474103	G52027		474409	G52275		474806	G56640		475091	G56616	

**Important Note:** Competitive Interchanges are to be used for stocking purposes only. Where multiple crosses are identified, please reference the applications section of this catalog. / **Remarque importante:** Les interchanges concurrentiels ne s'utilisent qu'aux fins de stocks. Dans le cas de rfrences multiples, consulter la section des applications du catalogue. / **Nota importante:** Dans le cas de rfrences multiples, consulter la section des applications du catalogue. / **Nota importante:** Se pueden usar intercambios competitivos para propósitos de almacenamiento solamente. Cuando se identifican intercambios múltiples, consulte la sección de aplicaciones de este catálogo.

**COMPETITIVE & O.E.M. INTERCHANGE LIST**  
**Lista de Intercambios contra Competidores y Equipo Original.**  
**Liste dinterchange de produits comptitifs & dquipement original (OEM)**

**PRT (ADD)... cont'd**

Prt (add)	Gabriel	Upgrade	Prt (add)	Gabriel	Upgrade	Prt (add)	Gabriel	Upgrade	Prt (add)	Gabriel	Upgrade
475091	G56688		475725	G56841		478313	G52006		710413	G57000	
475092	G56615		475726	G52351		478314	G52005		710415	G57080	
475092	G56687		475726	G56840		478323	G52396		710416	G57173	
475097	G56726		475915	G52128		478324	G52395		710419	G57683	
475107	G56700		475916	G52127		478479	G52330		710420	G57683	
475123	G56616		476007	G56778		478480	G52329		710423	G57573	
475123	G56688		476517	G52157		478587	G52383		710424	G57572	
475124	G56615		476518	G52156		478588	G52382		710475	G57080	
475124	G56687		476555	G52143		478675	G51947		710761	G57173	
475139	G56791		476556	G52142		478675	G51948		710771	G57706	
475139	G56792		476557	G52128		492117	70031		710787	G57683	
475149	G52145		476558	G52127		493923	G51921		710788	G57683	
475150	G52144		476565	G52125		493924	G51920		710793	G57415	
475211	G56561		476615	G52149		496629	G51871		710794	G57414	
475212	G56562		476616	G52148		583052	6850SE		710797	G57453	
475215	G56821		476617	G52294		583053	6847SE		710798	G57454	
475216	G56822		476618	G52293		583059	6847SE		710863	G57703	
475217	G51799		476619	G52254		583060	6853SE		710864	G57794	
475217	G56899		476620	G52253		584027	6856SE		710871	G57453	
475219	G51799		476621	70096		710002	G57118		710872	G57454	
475219	G56899		476623	G56837		710077	G57026		710875	G57134	
475239	G56688		476624	G56516		710077	G57075		710876	G57133	
475240	G56687		476624	G56836		710078	G57103		710877	G57683	
475267	G52159		476625	70096		710079	G57087		710878	G57683	
475268	G52158		476665	G52375		710080	G57086		710879	G57683	
475277	G52113		476666	G52374		710081	G57132		710880	G57683	
475278	G52112		476733	G52258		710082	G57132		710970	G57000	
475279	G52250		476734	G52257		710083	G57108		710970	G57023	
475280	G52249		476739	G52361		710084	G57107		710974	G57067	
475281	G55948		476740	G52360		710098	G57282		710983	G57068	
475283	G56509		476743	G52525		710099	G57027		710984	G57067	
475287	G52169		476744	G52524		710103	G57178		711010	G56943	
475288	G52168		476745	G52356		710103	G57607		711011	G57703	
475289	G52151		476746	G52355		710139	G57425		711016	G57057	
475290	G52150		476751	G52330		710140	G57424		711077	G57075	
475297	G52200		476752	G52329		710150L	G57416		711193	G57092	
475298	G52199		476755	G52128		710150R	G57682		711349	G57134	
475303	G52025		476756	G52127		710251	G57282		711350	G57133	
475303	G55948		476757	G52399		710252	G57092		711388	G57413	
475305	G52130		476758	G52398		710307	G57092		711388	G57646	
475306	G52129		476761	G52383		710310	G57423		711389	G57075	
475309	G52281		476762	G52382		710311	G57598		711392	G57423	
475310	G52280		476767	G52406		710312	G57597		712006	G57036	
475311	G52244		476793	G52301		710315	G57647		712161	G57159	
475315	G52113		476821	G52440		710317	G57646		712161	G57160	
475316	G52112		476822	G52439		710362	G57421		713002	G57010	
475321	G56799		476851	G52349		710370	G57675		713005	G57062	
475322	G56800		476852	G52348		710371	G57703		713006	G57061	
475323	G56791		477103	G52256		710373	G57429		713111L	G57090	
475323	G56792		477104	G52255		710374	G57428		713111R	G57091	
475327	G56799		477213	G51738		710375	G57646		713123	G56938	
475328	G56800		477701	G51738		710377	G57452		713171L	G57027	
475331	G56778		478281	G52330		710378	G57451		713171R	G57027	
475347	G52116		478282	G52329		710410	G57023		713193	G57056	
475697	G511000		478289	G56758		710411	G57036		713198L	G57133	
475725	G52352		478290	G56759		710412	G57579		713198R	G57134	

**Important Note:** Competitive Interchanges are to be used for stocking purposes only. Where multiple crosses are identified, please reference the applications section of this catalog. / **Remarque importante:** Les interchanges concurrentiels ne s'utilisent qu'aux fins de stocks. Dans le cas de références multiples, consulter la section des applications du catalogue. / **Nota importante:** Dans le cas de références multiples, consulter la section des applications du catalogue. / **Nota importante:** Se pueden usar intercambios competitivos para propósitos de almacenamiento solamente. Cuando se identifican intercambios múltiples, consulte la sección de aplicaciones de este catálogo.

**COMPETITIVE & O.E.M. INTERCHANGE LIST**  
**Lista de Intercambios contra Competidores y Equipo Original.**  
**Liste d'interchange de produits compititifs & d'equipement original (OEM)**

**PRT (ADD)... cont'd**

Prt (add)	Gabriel	Upgrade	Prt (add)	Gabriel	Upgrade	Prt (add)	Gabriel	Upgrade	Prt (add)	Gabriel	Upgrade
713223	G57607		810414	G57658		814135	G56933		814773	G57158	
713278L	G57451		810415	G57677		814136	G56932		814774	G57157	
713278R	G57452		810416	G57676		814139	G56928		814797	G57042	
713318	G57447		810425	G57659		814177	G57064		814798	G57041	
713391	G57573		810426	G57658		814178	G57063		814805	G57168	
713392	G57572		810473	G57191		814231	G57460		814806	G57167	
713397	G57598		810474	G57190		814232	G57459		814879	G56933	
713398	G57597		811021	G56726		814241	G57376		814879	G57044	
714004	G57019		811045L	G57135		814241	G57666		814880	G56932	
714009	G57124		811045R	G57136		814242	G57375		814880	G57043	
714009	G57221		811046L	G56991		814242	G57665		814907	G57151	
714010	G57123		811046R	G56992		814243	G57583		814908	G57150	
714010	G57220		812057	G57089		814244	G57582		814909	G57153	
714058L	G57065		812058	G57088		814251	G57474		814910	G57152	
714058R	G57066		812102	G57148		814252	G57473		814917	G57031	
714067	G57020		813003	G56931		814319	G56928		814918	G57030	
714068	G57021		813004	G56930		814323	G56964		814923	G57077	
714071	G57016		813073	G56950		814354	G56965		814924	G57076	
714075	G57080		813074	G56949		814368L	G57007		814961	G57070	
714078	G57021		813258L	G56993		814368R	G57008		814961	G57122	
714087	G57015		813258R	G56994		814381	G56975		814962	G57069	
714087	G57212		813331	G57022		814385	G57664		814962	G57121	
714088	G57095		813338	G57014		814386	G57663		814989	G57370	
714089	G57096		813453	G57146		814405	G57012		814990	G57369	
714109	G57023		813487	G57409		814406	G57011		815007	G57085	
714109	G57125		813491	G57035		814407L	G56956		815008	G57084	
715022	G57018		813492	G57034		814407R	G56957		815009	G57046	
715023	G57017		813493	G57048		814413	G57127		815010	G57045	
715029	G57172		813494	G57047		814414	G57126		815010	G57046	
715101	G57173		813497	G56997		814423	G57006		815011	G57051	
740098	G57282		813498	G56996		814433	G57276		815013	G57053	
745297	G52200		813653	G57397		814434	G57275		815017	G57039	
810071	G57466		813681	G57013		814523	G57342		815019	G57649	
810072	G57465		813685	G57059		814524	G57341		815020	G57648	
810110	G56998		813781	G57203		814525	G57158		815023	G56925	
810121	G57039		813782	G57202		814526	G57157		815024	G56924	
810145	G57354		813845	G57456		814545	G57120		815025	G56925	
810146	G57353		813846	G57455		814546	G57119		815026	G56924	
810147	G57645		813859	G57201		814547	G57115		815027	G57075	
810148	G57644		813860	G57200		814548	G57114		815029	G57613	
810161	G57391		813863	G57542		814557	G57219		815030	G57612	
810162	G57390		813864	G57541		814558	G57218		815037	G57026	
810163	G57635		813919	G57604		814579	G57106		815037	G57075	
810164	G57634		813920	G57603		814580	G57105		815041	G57145	
810173	G56933		814008	G56925		814587	G57534		815042	G57144	
810174	G56932		814008	G57060		814588	G57533		815043	G57497	
810199	G57500		814009	G57038		814635	G57077		815044	G57497	
810200	G57499		814010	G57037		814635	G57079		815047	G57153	
810407	G57739		814015L	G56924		814636	G57076		815048	G57152	
810408	G57738		814015R	G56925		814636	G57078		815049	G57747	
810409	G57484		814043	G56936		814743	G57050		815051	G57747	
810410	G57483		814078	G56936		814743	G57522		815052	G57746	
810410	G57658		814079	G56934		814744	G57049		815078	G56929	
810411	G57466		814079	G56937		814744	G57521		815123	G57145	
810412	G57465		814121	G57040		814765	G57279		815124	G57144	
810413	G57659		814128	G56927		814766	G57278		815165	G56935	

**Important Note:** Competitive Interchanges are to be used for stocking purposes only. Where multiple crosses are identified, please reference the applications section of this catalog./ **Remarque importante:** Les interchanges concurrentiels ne s'utilisent qu'aux fins de stocks. Dans le cas de rfrences multiples, consulter la section des applications du catalogue./ **Nota importante:** Dans le cas de rfrences multiples, consulter la section des applications du catalogue./ **Nota importante:** Se pueden usar intercambios competitivos para propósitos de almacenamiento solamente. Cuando se identifican intercambios múltiples, consulte la sección de aplicaciones de este catálogo.

**COMPETITIVE & O.E.M. INTERCHANGE LIST**  
**Lista de Intercambios contra Competidores y Equipo Original.**  
**Liste d'interchange de produits compétitifs & d'équipement original (OEM)**

**PRT (ADD)... cont'd**

Prt (add)	Gabriel	Upgrade	Prt (add)	Gabriel	Upgrade	Prt (add)	Gabriel	Upgrade	Prt (add)	Gabriel	Upgrade
815187	G56963		815967	G57578		816634	G57192		816957	G57109	
815187	G56964		815968	G57465		816635	G57191		816957	G57314	
815188	G56962		815968	G57577		816635	G57540		816959	G57324	
815188	G56963		815981	G57332		816636	G57190		817011	G57490	
815211	G57140		815981	G57480		816636	G57539		817012	G57489	
815212	G57139		815982	G57331		816637	G57191		817021	G57702	
815213	G57050		815982	G57479		816638	G57190		817022	G57701	
815214	G57049		816053	G56931		816639	G57060		817025	G57702	
815215	G57344		816054	G56930		816639	G57142		817026	G57701	
815216	G57343		816057	G56948		816643	G57129		817029	G57391	
815219	G57156		816058	G56948		816644	G57128		817030	G57390	
815219	G57277		816083	G57516		816645	G57131		817033	G57725	
815289	G57334		816084	G57515		816646	G57130		817034	G57724	
815290	G57333		816089	G57205		816651	G57111		817037	G57060	
815299	G57060		816090	G57204		816651	G57536		817041	G57725	
815299	G57142		816091	G57405		816652	G57110		817042	G57724	
815365	G57141		816092	G57404		816652	G57535		817059	G57142	
815367	G57193		816101	G56925		816653	G57113		817109	G57578	
815368	G57192		816102	G56924		816654	G57112		817110	G57577	
815373	G57397		816125	G57145		816657	G57138		817111	G57346	
815377	G57055		816126	G57144		816658	G57137		817112	G57345	
815378	G57054		816131	G57472		816679	G57099		817129	G57496	
815395	G57496		816132	G57471		816679	G57100		817130	G57495	
815396	G57495		816225	G57008		816681	G57206		817131	G57340	
815457	G57115		816226	G57007		816682	G57206		817132	G57339	
815458	G57114		816329	G57051		816705	G57149		817135	G57747	
815480	G57105		816333	G57035		816715	G57391		817136	G57746	
815881	G57559		816334	G57034		816716	G57390		817137	G57629	
815882	G57558		816335	G57193		816735	G57163		817137	G57705	
815883	G57373		816336	G57192		816736	G57164		817138	G57628	
815883	G57664		816339	G57142		816753	G57270		817138	G57704	
815884	G57372		816339	G57498		816769	G57733		817143	G57373	
815884	G57663		816340	G57497		816770	G57732		817144	G57372	
815907	G57274		816343	G57709		816773	G57427		817151	G57698	
815913	G57394		816345	G57022		816783	G57031		817152	G57697	
815914	G57393		816348	G57192		816784	G57030		817153	G57583	
815915	G57198		816385	G57151		816787	G57208		817157	G57496	
815915	G57323		816386	G57150		816788	G57207		817158	G57495	
815916	G57197		816387	G57582		816799	G57323		817163	G57418	
815916	G57198		816509	G57276		816800	G57322		817164	G57417	
815916	G57322		816510	G57275		816809	G57185		817177	G57378	
815917	G57567		816549	G57482		816810	G57184		817178	G57377	
815918	G57566		816550	G57481		816839	G57269		817487	G57378	
815925	G57106		816551	G57674		816840	G57268		817488	G57377	
815926	G57105		816552	G57673		816841	G57271		817895	G57518	
815937	G57427		816553	G57484		816937	G57419		817896	G57517	
815939	G57330		816554	G57483		816947	G57162		818050	G57746	
815940	G57329		816615	G57267		816947	G57368		818065	G57804	
815943	G57198		816615	G57751		816948	G57161		818066	G57803	
815944	G57197		816616	G57266		816948	G57367		818187	G57659	
815949	G57422		816616	G57750		816949	G57223		818188	G57658	
815953	G57550		816631	G57068		816950	G57222		818207	G57735	
815954	G57549		816631	G57358		816951	G57082		818208	G57734	
815959	G57148		816632	G57067		816952	G57081		818215	G57340	
815959	G57270		816632	G57357		816955	G57177		818216	G57339	
815967	G57466		816633	G57193		816956	G57176		818217	G57692	

**Important Note:** Competitive Interchanges are to be used for stocking purposes only. Where multiple crosses are identified, please reference the applications section of this catalog. / **Remarque importante:** Les interchanges concurrentiels ne s'utilisent qu'aux fins de stocks. Dans le cas de références multiples, consulter la section des applications du catalogue. / **Nota importante:** Dans le cas de références multiples, consulter la section des applications du catalogue. / **Nota importante:** Se pueden usar intercambios competitivos para propósitos de almacenamiento solamente. Cuando se identifican intercambios múltiples, consulte la sección de aplicaciones de este catálogo.

**COMPETITIVE & O.E.M. INTERCHANGE LIST**  
**Lista de Intercambios contra Competidores y Equipo Original.**  
**Liste dinterchange de produits comptitifs & dquipement original (OEM)**

**PRT (ADD)... cont'd**

Prt (add)	Gabriel	Upgrade	Prt (add)	Gabriel	Upgrade	Prt (add)	Gabriel	Upgrade	Prt (add)	Gabriel	Upgrade
818218	G57691		818689	G57474		819567	G57323		920216	G57781	
818219	G57659		818690	G57473		819567	G57550		920229	G57337	
818220	G57658		818691	G57378		819568	G57197		920230	G57338	
818221	G57378		818692	G57377		819568	G57322		920239	G57359	
818222	G57377		818693	G56933		819568	G57549		920240	G57360	
818289	G57606		818694	G56932		819569	G57198		920241	G57497	
818290	G57605		818695	G57565		819569	G57323		920242	G57498	
818297	G57690		818696	G57564		819570	G57197		920243	G57764	
818298	G57689		818885	G57098		819570	G57322		920244	G57765	
818305	G57120		818886	G57097		819573	G57031		920245	G57724	
818306	G57119		818891	G57561		819574	G57030		920246	G57725	
818307	G56951		818892	G57560		819575	G57140		920249	G57444	
818315	G57587		818899	G57812		819576	G57139		920250	G57444	
818316	G57586		818903	G57696		819579	G57330		920273	G57222	
818325	G56925		818904	G57695		819580	G57329		920274	G57223	
818326	G56924		818905	G57733		819581	G57330		920279	G57161	
818327	G57401		818906	G57732		819582	G57329		920280	G57162	
818328	G57400		818907	G57546		819583	G57350		920281	G57076	
818329	G57399		818908	G57545		819584	G57349		920282	G57077	
818330	G57398		818909	G57727		819587	G57463		920283	G57720	
818345	G57456		818910	G57726		819588	G57464		920284	G57721	
818345	G57595		818913	G57472		819789	G57498		920285	G57689	
818346	G57455		818914	G57471		819790	G57498		920286	G57690	
818346	G57594		818917	G57694		819931	G56974		920295	G57772	
818587	G57494		818918	G57693		819932	G56973		920296	G57773	
818588	G57493		818919	G57700		920009	G57635		920297	G57716	
818591	G57162		818920	G57699		920010	G57634		920298	G57717	
818592	G57161		818925	G57494		920020	G57635		920305	G57780	
818595	G57544		818926	G57493		920021	G57634		920306	G57781	
818596	G57543		818929	G57812		920041	G57518		920319	G57220	
818609	G57482		818931	G57083		920042	G57517		920320	G57221	
818610	G57481		818932	G57083		920059	G57748		920325	G57720	
818611	G57340		818933	G57690		920076	G57748		920326	G57721	
818612	G57339		818934	G57689		920081	G57690		920331	G57772	
818613	G57463		818941	G57206		920082	G57689		920332	G57773	
818614	G57464		818942	G57206		920101	G57765		920344	G57420	
818615	G57206		818945	G57083		920102	G57764		920345	G57800	
818616	G57206		818949	G57083		920103	G57765		920346	G57801	
818617	G57498		818961	G57518		920104	G57764		920347	G57799	
818618	G57497		818962	G57517		920118	G57421		920348	G57752	
818625	G57463		818983	G57206		920132	G57703		920349	G57753	
818626	G57464		818985	G57206		920134	G57156		920350	G57697	
818629	G57198		818986	G57206		920135	G57156		920351	G57698	
818630	G57197		818991	G57206		920136	G57156		920416	G57450	
818653	G57147		818992	G57206		920159	G57764		920417	G57449	
818667	G57649		819363	G57071		920161	G57734		920419	G57775	
818668	G57648		819363	G57072		920162	G57735		920420	G57774	
818669	G57039		819379	G57713		920165	G57803		920770	G57364	
818671	G57051		819380	G57712		920166	G57804		920771	G57363	
818675	G57194		819565	G57198		920169	G57784		925000	83002	
818675	G57195		819565	G57323		920170	G57785		925001	83008	
818677	G57148		819565	G57550		920181	G57772		925002	83011	
818679	G57203		819566	G57197		920182	G57773		925003	83012	
818680	G57202		819566	G57322		920200	G57716		925004	83016	
818683	G57563		819566	G57549		920201	G57717		925005	83017	
818684	G57562		819567	G57198		920215	G57780		925006	83021	

**Important Note:** Competitive Interchanges are to be used for stocking purposes only. Where multiple crosses are identified, please reference the applications section of this catalog. / **Remarque importante:** Les interchanges concurrentiels ne s'utilisent qu'aux fins de stocks. Dans le cas de rfrences multiples, consulter la section des applications du catalogue. / **Nota importante:** Dans le cas de rfrences multiples, consulter la section des applications du catalogue. / **Nota importante:** Se pueden usar intercambios competitivos para propósitos de almacenamiento solamente. Cuando se identifican intercambios múltiples, consulte la sección de aplicaciones de este catálogo.

**COMPETITIVE & O.E.M. INTERCHANGE LIST**  
**Lista de Intercambios contra Competidores y Equipo Original.**  
**Liste dinterchange de produits comptitifs & dquipement original (OEM)**

**PRT (ADD)... cont'd**

Prt (add)	Gabriel	Upgrade	Prt (add)	Gabriel	Upgrade	Prt (add)	Gabriel	Upgrade	Prt (add)	Gabriel	Upgrade
925007	83023		925066	G63622		925113	85047	89435	925158	89426	
925008	83024		925067	G63623		925113	89435		925159	85319	89428
925009	83025		925068	83180		925114	85054		925159	89428	
925010	83027		925069	83207	89407	925115	85055	89439	925160	85320	89429
925011	83028		925069	89407		925115	89439		925160	89429	
925012	83029		925070	83209	89414	925116	85058	89431	925161	85329	
925013	83035		925070	89414		925116	89431		925162	85331	
925014	83038		925071	83215		925118	85061	89450	925163	85335	
925015	83039		925072	83216		925119	85062	89408	925165	85343	
925016	83040		925073	83219		925119	89408		925166	85376	
925017	83041		925074	83221		925120	85063		925167	85637	
925018	83042		925075	83225		925121	85065		925168	85639	
925019	83044		925076	83303		925122	85066	89448	925169	85642	
925021	83047		925078	83308		925122	89448		925173	85716	
925022	83048		925079	83309		925123	85067	89451	925174	85722	
925024	83050		925080	83312	89409	925123	89451		925175	85724	89443
925025	83051		925080	89409		925124	85069	89455	925175	89443	
925026	83053		925081	83314		925124	89455		925178	85900	
925027	83054		925082	83317		925125	85070	89459	925179	85906	89407
925028	83056		925083	83364		925125	89459		925179	89407	
925029	83062		925084	83391		925126	85071		925180	85909	
925030	83065		925085	83395		925127	85072		925181	85918	89449
925033	83081		925086	83400		925128	85080		925181	89449	
925034	83101		925088	83518		925129	85081		925182	85919	
925035	83103		925089	83519		925130	85082		925183	85920	89503
925036	83107		925090	83613		925131	85084	89460	925183	89503	
925037	83109		925091	83901		925131	89460		925184	85656	
925038	83112		925093	83906		925132	85086		925185	85927	
925039	83114		925094	85001	89410	925133	85088		925186	85928	
925040	83120		925094	89410		925134	85090		925187	85932	89453
925041	83122	89406	925095	85004		925135	85061	89450	925187	89453	
925041	89406		925096	85005	89430	925136	85102		925188	85956	
925042	83123	89405	925096	89430		925137	85106		925189	85958	
925042	89405		925097	85006		925138	85109		925190	85959	
925043	83124	89407	925098	85007		925139	85119		925191	85965	
925043	89407		925099	85009		925142	85124		925192	85967	
925044	83125		925100	85012	89413	925143	85125		925193	85976	
925045	83126	89430	925100	89413		925145	85180		925194	89402	
925045	89430		925101	85013	89414	925146	85181		925199	G63306	
925046	83131		925101	89414		925148	85301		925208	G63610	
925047	83134		925102	85014		925149	85302	89420	925209	85736	
925048	83135		925103	85023	89415	925149	89420		925210	85902	
925049	83136		925103	89415		925150	85303	89422	925211	85921	
925050	83137		925104	85024		925150	89422		925212	85923	89458
925051	83140		925105	85026		925151	85304		925212	89458	
925052	83141		925106	85029		925152	85307		925213	85924	89457
925053	83142		925107	85030	89440	925153	85308	89422	925213	89457	
925054	83143		925107	89440		925153	89422		925214	85931	89458
925055	83147		925108	85031		925154	85310	89423	925214	89458	
925057	83154		925109	85033	89427	925154	89423		925215	85933	89454
925059	83159		925109	89427		925155	85311	89424	925215	89454	
925060	83160		925110	85036	89405	925155	89424		925216	85936	89456
925061	83162		925110	89405		925156	85314	89425	925216	89456	
925063	83166		925111	85043		925156	89425		925217	85937	
925064	83169		925112	85046	89434	925157	85315		925218	85954	
925065	83175		925112	89434		925158	85316	89426	925219	85957	

**Important Note:** Competitive Interchanges are to be used for stocking purposes only. Where multiple crosses are identified, please reference the applications section of this catalog. / **Remarque importante:** Les interchanges concurrentiels ne s'utilisent qu'aux fins de stocks. Dans le cas de rferences multiples, consulter la section des applications du catalogue. / **Nota importante:** Dans le cas de rferences multiples, consulter la section des applications du catalogue. / **Nota importante:** Se pueden usar intercambios competitivos para propósitos de almacenamiento solamente. Cuando se identifican intercambios múltiples, consulte la sección de aplicaciones de este catálogo.



**COMPETITIVE & O.E.M. INTERCHANGE LIST**  
**Lista de Intercambios contra Competidores y Equipo Original.**  
**Liste dinterchange de produits comptitifs & dquipement original (OEM)**

**PRT (ADD)... cont'd**

Prt (add)	Gabriel	Upgrade	Prt (add)	Gabriel	Upgrade	Prt (add)	Gabriel	Upgrade	Prt (add)	Gabriel	Upgrade
925220	85963		925267	89436		925306	85702		925373	83242	
925221	85964		925268	83401		925307	85704		925377	85700	
925222	85972		925269	83456	89447	925308	85708		925378	85705	89447
925224	85985		925269	89447		925309	85709		925378	89447	
925226	85988		925270	83635		925310	85711		925379	85732	
925227	85989		925271	85000	89436	925311	85712		925380	89437	
925228	85994		925271	89436		925314	85723		925397	81744	
925229	85995		925272	85003	89411	925315	85727		925406	85979	
925231	83001		925272	89411		925316	85728		925449	G63456	
925232	83003		925273	85010		925317	85729		925525	61682	
925233	83004		925274	85027		925318	85733		925531	61685	
925235	83006		925275	85040		925319	85734		925547	81318	
925236	83009		925276	85045		925321	89432		925562	G63889	
925238	83018		925277	85051		925330	85737		925563	G63889	
925239	83019		925278	85052		925331	85738		925566	61711	
925241	83022		925279	85053	89442	925332	85739		925567	61713	
925242	83031		925279	89442		925333	85740		925579	81920	
925243	83102		925281	85064		925334	85901		925607	83007	
925244	83105		925282	85078		925336	85908		930201	G51934	
925245	83110		925283	85079		925337	85910		930202	G51934	
925246	83111		925284	85087		925338	85911		930228	G52172	
925247	83113		925286	85300	89419	925339	85916	89430	930288	81676	
925249	83119		925286	89419		925339	89430		930293	G51921	
925250	83127		925287	85305		925340	85648		930294	G51920	
925251	83128	89436	925288	85318		925341	85929		930532	70040	
925251	89436		925289	85321		925342	85934		930665	G52295	
925252	83130		925290	85322		925343	85935		930754	G511037	
925254	83144		925291	85323	89436	925344	85938		930792	70040	
925255	83148		925291	89436		925345	85939		930799	G51965	
925256	83149		925292	85332		925346	85955		930848	14072	
925257	83150		925293	85333		925347	85961		932801	70096	
925258	83158		925294	85334		925348	85962		932803	61655	
925259	83164		925295	85337		925349	85970		932805	G51721	
925260	83168		925296	85338		925353	87015		932806	G51901	
925261	83203	89436	925297	85339		925355	87018		932819	G52495	
925261	89436		925298	85340		925363	83015		932820	G52494	
925262	83214		925299	85341		925364	83026		932845	G511044	
925264	83301		925301	85345		925365	83030		932855	69952	
925265	83318		925302	85351		925367	83034		932874	85007	
925266	83363		925303	85382		925368	83059		990002	49255	
925267	83389	89436	925304	85638		925372	83204				

**Rameriz Trailer**

Rameriz trailer	Gabriel	Upgrade	Rameriz trailer	Gabriel	Upgrade	Rameriz trailer	Gabriel	Upgrade	Rameriz trailer	Gabriel	Upgrade
18165-01	85006		1816501	85006							

**Raydan Manufacturing**

Raydan manufacturing	Gabriel	Upgrade	Raydan manufacturing	Gabriel	Upgrade	Raydan manufacturing	Gabriel	Upgrade	Raydan manufacturing	Gabriel	Upgrade
14QK-3100	85739		446-51-211	85739		700115	85712				
14QK3100	85739		44651211	85739							

**Red Lion Trailer**

Red lion trailer	Gabriel	Upgrade	Red lion trailer	Gabriel	Upgrade	Red lion trailer	Gabriel	Upgrade	Red lion trailer	Gabriel	Upgrade
90044978	85059		90044989	85059							

**Renegade RV**

Renegade rv	Gabriel	Upgrade	Renegade rv	Gabriel	Upgrade	Renegade rv	Gabriel	Upgrade	Renegade rv	Gabriel	Upgrade
10-13760-000	85959		10-13976-000	89449		1013976000	85918	89449	16-16764-000	85724	89443
10-13809-000	85958		1013760000	85959		1013976000	89449		16-16764-000	89443	
10-13976-000	85918	89449	1013809000	85958		141700005838	85061	89450	16-18708-000	85724	89443

**Important Note:** Competitive Interchanges are to be used for stocking purposes only. Where multiple crosses are identified, please reference the applications section of this catalog./ **Remarque importante:** Les interchanges concurrentiels ne s'utilisent qu'aux fins de stocks. Dans le cas de rfrences multiples, consulter la section des applications du catalogue./ **Nota importante:** Dans le cas de rfrences multiples, consulter la section des applications du catalogue./ **Nota importante:** Se pueden usar intercambios competitivos para propósitos de almacenamiento solamente. Cuando se identifican intercambios múltiples, consulte la sección de aplicaciones de este catálogo.

**COMPETITIVE & O.E.M. INTERCHANGE LIST**  
**Lista de Intercambios contra Competidores y Equipo Original.**  
**Liste dinterchange de produits comptitifs & dquipement original (OEM)**

**Renegade RV... cont'd**

Renegade rv	Gabriel	Upgrade	Renegade rv	Gabriel	Upgrade	Renegade rv	Gabriel	Upgrade	Renegade rv	Gabriel	Upgrade
16-18708-000	89443		20551628	85066	89448	471700000443	89448		SDA471700002809	89443	
1616764000	85724	89443	20551628	89448		471700002991	85959		SDA471700002991	85959	
1616764000	89443		20973993	85061	89450	471700003920	85958		SDA471700003920	85958	
1618708000	85724	89443	21436086	85061	89450	471700006040	85088				
1618708000	89443		21462380	85088		SDA471400003920	85958				
20433424	85061	89450	471700000443	85066	89448	SDA471700002809	85724	89443			

**Rex Mixer**

Rex mixer	Gabriel	Upgrade	Rex mixer	Gabriel	Upgrade	Rex mixer	Gabriel	Upgrade	Rex mixer	Gabriel	Upgrade
102-13441-10	646155										

**Reyco Suspension**

Reyco suspension	Gabriel	Upgrade	Reyco suspension	Gabriel	Upgrade	Reyco suspension	Gabriel	Upgrade	Reyco suspension	Gabriel	Upgrade
12885-01	85300	89419	1714601	83209	89414	1880001	89436		2352401	85738	
12885-01	89419		1714601	89414		19495-01	83126	89430	23553-01	85938	
12885-03	85300	89419	17358-01	83126	89430	19495-01	89430		2355301	85938	
12885-03	89419		17358-01	89430		1949501	83126	89430	24392-01	85051	
1288501	85300	89419	1735801	83126	89430	1949501	89430		2439201	85051	
1288501	89419		1735801	89430		19623-01	83123	89405	665519	89414	
1288503	85300	89419	17403-01	83122	89406	19623-01	89405		665748	85086	
1288503	89419		17403-01	89406		1962301	83123	89405	665813	85051	
12886-01	85334		1740301	83122	89406	1962301	89405		665830	85045	
1288601	85334		1740301	89406		19824-01	85006		665833	85052	
12887-01	85013	89414	17408-01	85005	89430	1982401	85006		671707	85323	89436
12887-01	89414		17408-01	89430		20125-01	85030	89440	671707	89436	
12887-02	85013	89414	1740801	85005	89430	20125-01	89440		680551	85738	
12887-02	89414		1740801	89430		2012501	85030	89440	680552	85938	
1288701	85013	89414	17794-01	83215		2012501	89440		680700	85938	
1288701	89414		1779401	83215		20126-01	89440		700098-01	83128	89436
1288702	85013	89414	18163-01	83207	89407	20129-01	85007		700098-01	89436	
1288702	89414		18163-01	89407		2012901	85007		700098-03	85052	
16230-01	85702		1816301	83207	89407	20960-01	83204		70009801	83128	89436
1623001	85702		1816301	89407		2096001	83204		70009801	89436	
16725-01	83126	89430	18164-01	83122	89406	21310-01	85307		70009803	85052	
16725-01	89430		18164-01	89406		2131001	85307		701071-01	665937	
1672501	83126	89430	1816401	83122	89406	21497-01	85005	89430	702135-01	85045	
1672501	89430		1816401	89406		21497-01	89430		70213501	85045	
16824-01	85006		18165-01	85006		2149701	85005	89430	702136-01	85052	
1682401	85006		1816501	85006		2149701	89430		70213601	85052	
17142-01	85001	89410	18166-01	85704		22062-01	85007		702209-01	85014	
17142-01	89410		1816601	85704		2206201	85007		70220901	85014	
1714201	85001	89410	18286-01	89414		23106-01	89430		704672-01	85938	
1714201	89410		18800-01	83203	89436	23523-01	85086		70467201	85938	
17146-01	83209	89414	18800-01	89436		2352301	85086				
17146-01	89414		1880001	83203	89436	23524-01	85738				

**Ridewell Corp.**

Ridewell corp.	Gabriel	Upgrade	Ridewell corp.	Gabriel	Upgrade	Ridewell corp.	Gabriel	Upgrade	Ridewell corp.	Gabriel	Upgrade
1250005	85901		1265157B000	85712		1270789B000	85014		665267	85029	
1250546B000	85006		1265478B000	85736		1275813B000	85704		665526	85014	
1250563B000	85000	89436	1266009B000	83130		1275943B	85005	89430	680101	85702	
1250563B000	89436		1267120B000	85734		1275943B	89430		70654	85000	89436
1250789B000	85014		1267249B000	85712		1310002	665937		70654	89436	
1252607B000	85702		1267395B000	85302	89420	1310004	665937		90-1813	85712	
1253069B000	85005	89430	1267395B000	89420		1317570B001	646155		901813	85712	
1253069B000	89430		1270007	85045		57645	85005	89430	AS 4025B	85712	
1254025B000	85712		1270563B000	85000	89436	57645	89430		AS30698	85005	89430
1254190B000	85302	89420	1270563B000	89436		665198	85005	89430	AS30698	89430	
1254190B000	89420		1270563B003	85934		665198	89430		AS3069B	85005	89430

**Important Note:** Competitive Interchanges are to be used for stocking purposes only. Where multiple crosses are identified, please reference the applications section of this catalog. / **Remarque importante:** Les interchanges concurrentiels ne s'utilisent qu'aux fins de stocks. Dans le cas de références multiples, consulter la section des applications du catalogue. / **Nota importante:** Dans le cas de referencias multiples, consultar la sección de aplicaciones del catálogo. / **Nota importante:** Se pueden usar intercambios competitivos para propósitos de almacenamiento solamente. Cuando se identifican intercambios múltiples, consulte la sección de aplicaciones de este catálogo.

**COMPETITIVE & O.E.M. INTERCHANGE LIST**  
**Lista de Intercambios contra Competidores y Equipo Original.**  
**Liste dinterchange de produits comptitifs & dquipement original (OEM)**

**Ridewell Corp.... cont'd**

Ridewell corp.	Gabriel	Upgrade	Ridewell corp.	Gabriel	Upgrade	Ridewell corp.	Gabriel	Upgrade	Ridewell corp.	Gabriel	Upgrade
AS3069B	89430		AS789B	85014		S5813B	85704		S7172B	83207	89407
AS546B	85006		AS789B000	85014		S5878B	83207	89407	S7172B	89407	
AS563B	83203	89436	S2607B	85702		S5878B	89407		S7249B	85307	
AS563B	89436		S4025B	85712		S6009B	83203	89436	S7365B	85305	
AS575B	85005	89430	S5477B	85307		S6009B	89436				
AS575B	89430		S5478B	85307		S7120B	85304				

**RIG TOUGH**

Rig tough	Gabriel	Upgrade	Rig tough	Gabriel	Upgrade	Rig tough	Gabriel	Upgrade	Rig tough	Gabriel	Upgrade
0202737RTB	85062	89408	0307421RTB	85311	89424	C711002RTB	85067	89451			
0202738RTB	85012	89413	0307423RTB	85033	89427	C711011RTB	85069	89455			

**Roadmaster (Monaco)**

Roadmaster (monaco)	Gabriel	Upgrade	Roadmaster (monaco)	Gabriel	Upgrade	Roadmaster (monaco)	Gabriel	Upgrade	Roadmaster (monaco)	Gabriel	Upgrade
90045132	85909		90045188	85910							

**Sabo**

Sabo	Gabriel	Upgrade	Sabo	Gabriel	Upgrade	Sabo	Gabriel	Upgrade	Sabo	Gabriel	Upgrade
8901020	85300	89419	8901025	85000	89436	8901029	89428		890120	85300	89419
8901020	89419		8901025	89436		8901029	89443		890120	89419	
8901021	85320	89429	8901026	85064		8901030	85323	89436	890414	85323	89436
8901021	89429		8901027	85310	89423	8901030	89436		890414	89436	
8901023	85066	89448	8901027	89423		8901031	85900		890449	85300	89419
8901023	89448		8901028	85316	89426	8901032	85901		890449	89419	
8901024	85314	89425	8901028	89426		8901033	85918	89449	895315	83009	
8901024	89425		8901029	85319	89428	8901033	89449		895316	83002	
8901025	83128	89436	8901029	85724	89443	8901156	G63299				

**Sachs**

Sachs	Gabriel	Upgrade	Sachs	Gabriel	Upgrade	Sachs	Gabriel	Upgrade	Sachs	Gabriel	Upgrade
030 086	G51759		030 255	G63418		030 760	G63443		031 267	G56571	
030 094	G51888		030 257	G63455		030 767	G63671		031 279	G56640	
030 095	G51887		030 261	G63490		030 768	G63411		031 280	G56641	
030 098	G56655		030 262	G63492		030 777	G63623		031 289	G63864	
030 100	G56817		030 262	G63928		030 780	G63638		031 295	G51716	
030 202	G63357		030 265	G63915		030 780	G63896		031 304	G51838	
030 204	G63375		030 266	G63950		030 798	G63722		031 336	G56731	
030 204	G63894		030 267	69625		030 814	69473		031 337	G56730	
030 205	G63386		030 281	G51871		030 817	G63837		031 338	G56735	
030 209	G63421		030 282	G51904		030 838	G63848		031 339	G56734	
030 210	G63422		030 296	G51704		030 844	G63879		031 347	G51714	
030 211	G63423		030 297	G63867		030 848	G63773		031 350	G63815	
030 212	G63424		030 297	G64157		030 854	69962		031 351	G63815	
030 212	G63721		030 298	G51703		030 872	69590		031 363	G56636	
030 214	G63454		030 299	G63870		030 875	G63958		031 364	G56635	
030 215	G63461		030 314	69574		030 877	G63962		031 365	G52013	
030 218	G63607		030 315	69575		030 878	G63810		031 366	G52014	
030 219	G63608		030 320	G51722		030 879	G63808		031 367	G51736	
030 219	G63614		030 321	G51724		030 881	G64087		031 374	70001	
030 221	G63609		030 334	G56809		030 980	49228		031 383	G52168	
030 221	G63818		030 335	G56809		030 980	49255		031 384	G52169	
030 222	G63907		030 645	G55697		031 084	G63494		031 388	G51802	
030 226	69600		030 660	G55772		031 085	G63404		031 392	70028	
030 229	69675		030 667	G51267		031 091	G63548		031 393	G52098	
030 230	69676		030 669	G55820		031 095	G63616		031 422	G51849	
030 243	G63350		030 671	G55901		031 098	G63903		033 011	G56927	
030 244	G63353		030 676	G56701		031 103	G63782		033 020	G56935	
030 245	G63360		030 699	G55896		031 105	G63707				
030 247	G63377		030 729	69845		031 106	G63708				
030 248	G63387		030 731	69898		031 110	G63726				
030 252	G63409		030 747	G51268		031 257	G56565				

**Important Note:** Competitive Interchanges are to be used for stocking purposes only. Where multiple crosses are identified, please reference the applications section of this catalog./ **Remarque importante:** Les interchanges concurrentiels ne s'utilisent qu'aux fins de stocks. Dans le cas de rfrences multiples, consulter la section des applications du catalogue./ **Nota importante:** Dans le cas de rfrences multiples, consulter la section des applications du catalogue./ **Nota importante:** Se pueden usar intercambios competitivos para propósitos de almacenamiento solamente. Cuando se identifican intercambios múltiples, consulte la sección de aplicaciones de este catálogo.

**COMPETITIVE & O.E.M. INTERCHANGE LIST**  
**Lista de Intercambios contra Competidores y Equipo Original.**  
**Liste dinterchange de produits comptitifs & dquipement original (OEM)**

**Sachs... cont'd**

Sachs	Gabriel	Upgrade	Sachs	Gabriel	Upgrade	Sachs	Gabriel	Upgrade	Sachs	Gabriel	Upgrade
033 023	G57064		170 823	69903		310 225	G63775		311 409	70045	
033 024	G57063		170 828	69903		310 227	G63679		311 410	70045	
033 036	G56957		230 048	G63799		310 231	G63414		311 538	G51773	
033 037	G56956		230 303	G51841		310 235	G63778		311 543	G52276	
033 044	G56997		230 709	G56517		310 249	69606		311 750	70039	
033 045	G56996		230 710	G56516		310 253	G63715		311 752	70040	
033 046	G56998		280 325	G63781		310 261	G63525		311 753	70040	
033 054	G56948		280 355	69465		310 272	G63676		311 801	69909	
033 055	G56948		280 523	69450		310 272	G63873		311 820	69585	
033 056	G56949		280 757	G64028		310 273	G52314		311 821	G63717	
033 057	G56950		280 867	G63832		310 274	G52314		311 823	G63714	
033 088	G57178		280 869	G63828		310 277	G63776		311 944	G56688	
033 089	G57176		280499	85300	89419	310 277	G63869		311 945	G56687	
033 090	G57177		280499	89419		310 284	G63489		311 946	G56688	
033 103	G56991		290 005	G64027		310 287	G63488		311 947	G56687	
033 103	G56992		290 074	G55999		310 291	G55698		311229	85918	89449
033 105	G56943		290 075	G55999		310 312	G63783		311229	89449	
033 107	G57054		290 078	G55662		310 315	G63355		311230	85956	
033 107	G57055		290 079	G55661		310 315	G63366		311631	85906	89407
033 108	G57056		290 082	G55591		310 317	G63349		311631	89407	
033 113	G57114		290 083	G55591		310 322	G52025		311632	85909	
033 114	G57115		290 236	G52165		310 325	G63662		311633	85900	
033 317	G63878		290 237	G52164		310 325	G63675		311634	85001	89410
101 471	69787		290 238	G51881		310 325	G63959		311634	89410	
101 705	69996		290 239	G52145		310 328	G63803		311635	85030	89440
101892	85708		290 240	G52144		310 328	G63893		311635	89440	
101968	85708		290 379	G63918		310 343	G63813		311793	85916	89430
105 828	69901		290 561	G56591		310 350	G63299		311793	89430	
106 798	69677		290 780	G55911		310 425	G51900		312 130	G51718	
106282	85722		290 781	G55911		310 684	G56616		312 131	G63842	
106884	85708		290 949	G52237		310 685	G56615		312 134	G51738	
106885	85722		290 950	G52238		310 688	G63845		312 138	G56758	
112885	85709		290146	85012	89413	310 706	69813		312 139	G56759	
115 906	G56778		290146	89413		310 718	G52199		312 154	70000	
124 390	69952		290460	85005	89430	310 719	G52200		312 170	G51883	
124693	85708		290460	89430		310 720	70034		312 178	G56672	
141700000370	89450		290465	83125		310 838	G52275		312 179	G56671	
141700000373	85061	89450	290488	85040		310 839	G52274		312 184	G51727	
141700000378	83160		300 138	G56791		310 842	G51841		312 186	G52009	
141700000380	85061	89450	303 903	70041		310 897	G63712		312 187	G52008	
141700000440	85066	89448	310 027	69946		310 950	G51799		312 188	G51798	
141700000440	89448		310 032	G51087		310 985	G52142		312 209	G51767	
141700000443	85066	89448	310 173	G63413		310 986	G52143		312 214	G51739	
141700000443	89448		310 175	G63905		311 013	G56899		312 215	G63885	
141700002626	85061	89450	310 178	G63661		311 041	69604		312 215	G64029	
141700002630	89450		310 183	G63359		311 041	69724		312 215	G64030	
141700005838	85061	89450	310 190	G63683		311 120	G63958		312 218	G51804	
141700005839	85061	89450	310 191	G63425		311 120	G64043		312 222	G52108	
141700131809	85029		310 202	G56620		311 121	G63961		312 222	G56798	
141700131810	83160		310 203	G63426		311 122	G51728		312 223	G52107	
141700131975	83160		310 203	G63690		311 123	G63844		312 223	G56797	
141700131980	83160		310 218	G63622		311 212	G63817		312 278	G44461	
152C030010	83317		310 218	G63929		311 233	G64046		312 280	G44461	
152E030030	85014		310 219	G63624		311 237	G63720		312 326	G56539	
170 811	G51097		310 224	G63716		311 312	G56729		312 327	G56540	
170 819	G51742		310 225	G63678		311 313	G56728		312 473	G64016	

**Important Note:** Competitive Interchanges are to be used for stocking purposes only. Where multiple crosses are identified, please reference the applications section of this catalog. / **Remarque importante:** Les interchanges concurrentiels ne s'utilisent qu'aux fins de stocks. Dans le cas de références multiples, consulter la section des applications du catalogue. / **Nota importante:** Dans le cas de références multiples, consulter la section des applications du catalogue. / **Nota importante:** Se pueden usar intercambios competitivos para propósitos de almacenamiento solamente. Cuando se identifican intercambios múltiples, consulte la sección de aplicaciones de este catálogo.

**COMPETITIVE & O.E.M. INTERCHANGE LIST**  
**Lista de Intercambios contra Competidores y Equipo Original.**  
**Liste dinterchange de produits comptitifs & dquipement original (OEM)**

**Sachs... cont'd**

Sachs	Gabriel	Upgrade	Sachs	Gabriel	Upgrade	Sachs	Gabriel	Upgrade	Sachs	Gabriel	Upgrade
312 475	G63892		313 455	G52184		314 038	G52173		315 197	G51908	
312 485	G52110		313 456	G52185		314 044	G64050		315 227	G51807	
312 486	G52111		313 474	G63884		314 125	G52295		315 251	G52383	
312 587	G56568		313 475	G63882		314 166	69714		315 252	G52382	
312 588	G56601		313 477	G63875		314 167	69795		315 278	G56773	
312 589	69900		313 517	G52154		314 168	69811		315 279	G56774	
312 702	G63847		313 518	G52155		314 220	69622		315 280	G51870	
312 703	G63829		313 520	G52257		314 225	69755		315 306	G56562	
312 739	G52018		313 521	G52258		314 226	G55856		315 307	G56561	
312 740	G52017		313 522	G64071		314 243	G63673		315 308	69907	
312 743	G56893		313 523	G511054		314 258	G63710		315 641	G52148	
312 744	G56892		313 524	G511055		314 259	G55994		315 642	G52149	
312 782	70024		313 526	70078		314 260	G63937		315 644	G52117	
312 784	69586		313 527	G52160		314 261	G63620		315 645	G52118	
312 880	G56680		313 528	G52161		314 270	G55993		315 646	G51863	
312 881	G56679		313 588	G56633		314 288	G63904		315 785	G51815	
312 901	G56733		313 589	G56634		314 288	G63909		315 786	G51855	
312 902	G56732		313 620	G56841		314 299	G63495		315 787	G64038	
312 929	G51795		313 621	G56840		314 299	G63611		315 790	G51910	
312 932	G51814		313 622	G64037		314 300	69715		315 792	G51858	
312 933	G51813		313 624	G63889		314 355	69587		315 793	70010	
312 963	G51812		313 624	G64006		314 356	69589		315 796	G52253	
312 984	G52082		313 625	G64009		314 423	G63890		315 797	G52254	
312 985	G52081		313 625	G64011		314 423	G63891		315 801	G51919	
312 986	G51842		313 626	G56537		314 461	G52348		315 804	G51860	
312724	85311	89424	313 627	G56538		314 462	G52349		315 805	G51861	
312724	89424		313 660	G52282		314 463	G51928		315 809	G52182	
313 093	G56660		313 661	G52283		314 469	G64032		315 810	G52183	
313 094	G56661		313 663	G51833		314 621	69464		315 826	G51911	
313 096	G55774		313 665	G52275		314 660	G52335		315 854	70040	
313 097	G55774		313 667	G52274		314 661	G52336		315 897	G51983	
313 123	G63610		313 669	70056		314 752	G51783		315 898	G51983	
313 202	G52175		313 671	69595		314 754	70036		315 918	G52129	
313 203	G52176		313 672	69594		314 757	G56842		315 919	G52130	
313 237	G52095		313 738	G52297		314 758	G56843		315 924	G52131	
313 238	G52094		313 739	G52298		314 766	G56886		315 925	G64042	
313 239	70027		313 741	G51934		314 767	G56887		315389	85090	
313 243	G52122		313 767	G56799		314 845	G52007		315390	85918	89449
313 244	G52121		313 768	G56800		314 846	G52004		315390	89449	
313 245	70089		313 785	G64033		314 863	G64026		315391	85956	
313 252	G51993		313 808	G56581		314 894	G52439		315392	85007	
313 254	G52142		313 809	G56582		314 895	G52440		315392	85329	
313 255	G52143		313 849	G56894		314 994	G56819		315393	85331	
313 258	G51723		313 854	G51859		314 995	G56820		315394	85921	
313 262	69592		313 854	G51897		314 996	G56822		315395	85724	89443
313 262	69593		313 855	G51859		314 997	G56821		315395	89443	
313 263	G56807		313 855	G51896		315 087	G56606		315396	85335	
313 264	G64012		313 856	69591		315 127	G56810		315397	83120	
313 265	G51715		313 861	G51794		315 128	G56810		315398	85058	89431
313 277	G56514		313 880	G511004		315 129	G63872		315398	89431	
313 278	G56506		313 881	G52300		315 129	G64015		315399	85005	89430
313 279	G55676		313 882	G52299		315 129	G64140		315399	89430	
313 280	G55675		313 977	G51841		315 148	G51850		315400	85006	
313 411	G52005		313 983	G63883		315 150	70052		315401	85331	
313 415	G52006		314 007	70098		315 171	G52162		315402	85900	
313 419	70003		314 037	G52174		315 172	G52163		315403	85919	

**Important Note:** Competitive Interchanges are to be used for stocking purposes only. Where multiple crosses are identified, please reference the applications section of this catalog./ **Remarque importante:** Les interchanges concurrentiels ne s'utilisent qu'aux fins de stocks. Dans le cas de rfrences multiples, consulter la section des applications du catalogue./ **Nota importante:** Dans le cas de rfrences multiples, consulter la section des applications du catalogue./ **Nota importante:** Se pueden usar intercambios competitivos para propósitos de almacenamiento solamente. Cuando se identifican intercambios múltiples, consulte la sección de aplicaciones de este catálogo.

**COMPETITIVE & O.E.M. INTERCHANGE LIST**  
**Lista de Intercambios contra Competidores y Equipo Original.**  
**Liste dinterchange de produits comptitifs & dquipement original (OEM)**

Sachs... cont'd

Sachs	Gabriel	Upgrade	Sachs	Gabriel	Upgrade	Sachs	Gabriel	Upgrade	Sachs	Gabriel	Upgrade
315404	85900		315551	85310	89423	315659	83047		316 561	G52245	
315406	85918	89449	315551	89423		315660	83009		316 562	G52246	
315406	89449		315552	83389	89436	315661	85932	89453	316 563	G51898	
315411	83128	89436	315552	85000	89436	315661	89453		316 578	G51864	
315411	89436		315552	89436		315840	83126	89430	316 579	G51865	
315412	85106		315553	85900		315840	89430		316 580	G64079	
315413	85932	89453	315554	83125		316 39	83215		316 589	70068	
315413	89453		315555	83001		316 396	G52127		316 595	G51806	
315414	85959		315556	83215		316 397	G52128		316 596	G51806	
315415	85933	89454	315558	85062	89408	316 398	G56837		316 597	G52439	
315415	89454		315558	89408		316 399	G56836		316 598	G52440	
315416	85003	89411	315593	85029		316 402	G52204		316 624	G51805	
315416	89411		315594	85029		316 403	G52203		316 625	G52106	
315417	85923	89458	315597	85959		316 404	G52202		316 626	G52105	
315417	85931	89458	315598	85933	89454	316 405	G52201		316 629	G56679	
315417	89458		315598	89454		316 408	G52188		316 630	G56680	
315418	83456	89447	315599	85109		316 409	G52187		316 633	G51765	
315418	89447		315600	85918	89449	316 410	G51878		316 638	G63886	
315420	85014		315600	89449		316 411	G51877		316 638	G63969	
315421	85088		315601	85959		316 412	G51892		316 639	G52152	
315422	85708		315603	83134		316 413	G64008		316 641	G51905	
315423	83127		315604	85053	89442	316 414	G64040		316 645	G52033	
315424	85067	89451	315604	89442		316 415	G52125		316 646	G52032	
315424	89451		315606	85061	89450	316 416	G52248		316 647	G51803	
315426	85007		315607	85061	89450	316 417	G52247		316 651	G52209	
315427	85713		315608	85061	89450	316 419	G52104		316 652	G52210	
315431	85014		315608	85066	89448	316 420	G52103		316 653	G64056	
315432	83209	89414	315608	89448		316 421	G52116		316 654	G52260	
315432	85013	89414	315609	85066	89448	316 422	G52157		316 655	G52261	
315432	89414		315609	89448		316 423	G52156		316 662	70060	
315434	85065		315610	83026		316 424	G52250		316 664	G52293	
315435	85088		315611	85006		316 425	G52249		316 665	G52294	
315536	85086		315612	85006		316 426	G64003		316 666	G51933	
315540	83613		315613	85030	89440	316 426	G64080		316 667	70096	
315541	85052		315613	85909		316 427	G52141		316 668	G51926	
315542	83122	89406	315613	89440		316 428	G52140		316 669	G51925	
315542	85005	89430	315614	83125		316 434	G51884		316 674	G52150	
315542	89406		315615	83027		316 438	70053		316 675	G52151	
315542	89430		315616	83038		316 439	G52331		316 679	G52026	
315543	85734		315617	85918	89449	316 440	G52332		316 680	G52027	
315544	83124	89407	315617	89449		316 441	G64048		316 686	G52112	
315544	85014		315618	83160		316 442	G51852		316 687	G52113	
315544	89407		315619	83160		316 443	G52096		316 707	G51990	
315545	85316	89426	315620	85080		316 444	G52097		316 747	70013	
315545	85333		315621	85080		316 445	G52158		316 749	G51853	
315545	89426		315622	85081		316 446	G52159		316 750	G51854	
315546	85005	89430	315623	85918	89449	316 447	G52264		316 772	G51891	
315546	89430		315623	89449		316 448	G52265		316 774	G51891	
315547	85924	89457	315624	85959		316 462	G63888		316 775	G63866	
315547	89457		315626	85933	89454	316 463	G64111		316 777	G63866	
315548	85070	89459	315626	89454		316 467	G52375		316 842	G56721	
315548	89459		315654	85070	89459	316 468	G51961		316 843	G56722	
315549	85033	89427	315654	89459		316 469	G52374		316 881	G51972	
315549	89427		315655	85937		316 496	G56509		316 923	G51766	
315550	85311	89424	315656	83040		316 497	G51832		316 924	G64031	
315550	89424		315657	83039		316 498	G51880		316302	83163	

**Important Note:** Competitive Interchanges are to be used for stocking purposes only. Where multiple crosses are identified, please reference the applications section of this catalog. / **Remarque importante:** Les interchanges concurrentiels ne s'utilisent qu'aux fins de stocks. Dans le cas de rferences multiples, consulter la section des applications du catalogue. / **Nota importante:** Dans le cas de rferences multiples, consulter la section des applications du catalogue. / **Nota importante:** Se pueden usar intercambios competitivos para propósitos de almacenamiento solamente. Cuando se identifican intercambios múltiples, consulte la sección de aplicaciones de este catálogo.

**COMPETITIVE & O.E.M. INTERCHANGE LIST**  
**Lista de Intercambios contra Competidores y Equipo Original.**  
**Liste dinterchange de produits comptitifs & dquipement original (OEM)**

**Sachs... cont'd**

Sachs	Gabriel	Upgrade	Sachs	Gabriel	Upgrade	Sachs	Gabriel	Upgrade	Sachs	Gabriel	Upgrade
316303	83136		316829	83041		317936	85030	89440	410057	83137	
316305	83219		316830	85051		317936	89440		410057	85013	89414
316305	85023	89415	316831	85043		317937	83148		410057	89414	
316305	89415		316832	83120		317938	85012	89413	410058	83122	89406
316306	85319	89428	316833	83112		317938	89413		410058	89406	
316306	89428		316834	85058	89431	317939	83314		410068	85030	89440
316307	85036	89405	316834	89431		317940	85053	89442	410068	85054	
316307	89405		316835	83110		317940	89442		410068	89440	
316308	85321		316836	85055	89439	317941	85302	89420	471700000426	85014	
316309	85901		316836	89439		317941	89420		471700000428	85006	
316310	85311	89424	316837	83312	89409	317943	85979		471700000430	85066	89448
316310	89424		316837	89409		317944	87015		471700000430	89448	
316311	85047	89435	316838	83309		317945	83515		471700000431	85066	89448
316311	89435		316839	83215		317953	85301		471700000431	89448	
316312	83136		316840	83126	89430	317955	632147		471700000436	85030	89440
316313	85061	89450	316840	85030	89440	317956	83025		471700000436	89440	
316314	85064		316840	89430		317957	83225		471700000440	85959	
316314	85938		316840	89440		317957	85007		471700000443	85066	89448
316316	85936	89456	316841	85303	89422	317958	83308		471700000443	89448	
316316	89456		316841	89422		317959	83400		471700000445	85080	
316318	85045		317 966	G63183		317960	85054		471700000447	85919	
316318	85052		317529	83154		317961	85338		471700000449	85918	89449
316319	83130		317530	646155		317962	85311	89424	471700000449	89449	
316320	85030	89440	317531	83048		317962	89424		471700000450	85080	
316320	89440		317532	83051		317963	85740		471700000450	85918	89449
316321	83317		317533	85052		317964	85029		471700000450	85919	
316322	85300	89419	317534	85084	89460	317965	83163		471700000450	89449	
316322	89419		317534	85989		317966	G63183		471700000451	85080	
316478	85331		317534	89460		40A850	85708		471700000458	85014	
316485	85959		317535	83008		410009	83102		471700000459	85030	89440
316488	85919		317536	85738		410010	83317		471700000459	89440	
316490	85010		317772	83029		410021	83125		471700000460	85090	
316491	85013	89414	317773	85656		410022	85006		471700000460	89414	
316491	89414		317774	83122	89406	410024	85302	89420	471700000460	89440	
316493	85010		317774	89406		410024	89420		471700000461	89414	
316814	85026		317776	83209	89414	410025	83215		471700000464	85090	
316815	85030	89440	317776	89414		410026	85918	89449	471700000466	85959	
316815	89440		317777	85648		410026	89449		471700000470	85918	89449
316816	85012	89413	317778	83045		410032	85001	89410	471700000470	89449	
316816	89413		317779	85045		410032	89410		471700002627	85066	89448
316817	85954		317779	85939		410035	85001	89410	471700002627	89448	
316818	85046	89434	317780	83030		410035	85337		471700002630	85066	89448
316818	89434		317781	83035		410035	89410		471700002630	89448	
316819	85055	89439	317782	83207	89407	410036	85061	89450	471700002726	85918	89449
316819	89439		317782	89407		410037	85081		471700002726	89449	
316820	85012	89413	317783	85024		410040	85909		471700002727	85959	
316820	89413		317928	646177		410042	85310	89423	471700002730	85918	89449
316821	83111		317929	83019		410042	89423		471700002730	85959	
316822	85978		317930	83025		410043	85957		471700002730	89449	
316823	85072		317931	83049		410044	85031		471700002809	85724	89443
316824	85069	89455	317932	83101		410046	83136		471700002809	89443	
316824	89455		317933	83103		410047	85071		471700002810	85724	89443
316825	83021		317934	83123	89405	410048	85014		471700002810	89443	
316826	83031		317934	89405		410056	83389	89436	471700002861	85014	
316827	83002		317935	83142		410056	85000	89436	471700002919	85106	
316828	83041		317936	83144		410056	89436		471700002920	85106	

**Important Note:** Competitive Interchanges are to be used for stocking purposes only. Where multiple crosses are identified, please reference the applications section of this catalog. / **Remarque importante:** Les interchanges concurrentiels ne s'utilisent qu'aux fins de stocks. Dans le cas de références multiples, consulter la section des applications du catalogue. / **Nota importante:** En el caso de referencias múltiples, consultar la sección de aplicaciones del catálogo. / **Nota importante:** Se pueden usar intercambios competitivos para propósitos de almacenamiento solamente. Cuando se identifican intercambios múltiples, consulte la sección de aplicaciones de este catálogo.



**COMPETITIVE & O.E.M. INTERCHANGE LIST**  
**Lista de Intercambios contra Competidores y Equipo Original.**  
**Liste d'interchange de produits complitifs & d'equpement original (OEM)**

**Sachs... cont'd**

Sachs	Gabriel	Upgrade	Sachs	Gabriel	Upgrade	Sachs	Gabriel	Upgrade	Sachs	Gabriel	Upgrade
471700002990	85007		471700131920	89454		610 018	G63479		802 536	143473	
471700002991	85959		471700131921	85933	89454	610 018	G63547		802 540	143422	
471700002992	85331		471700131921	89454		610 023	G63405		802 582	143495	
471700002993	85921		471700131970	85029		610 078	G63403		802 583	143318	
471700002994	83134		471700131974	85029		610 092	G63772		802 585	143391	
471700002995	83134		481700000207	85329		613 640	G52153		802 586	143390	
471700002996	85335		481700000209	85713		802 003	142135		802 590	143415	
471700003000	85335		481700000210	85329		802 061	142444		802 594	143363	
471700003009	85006		481700000210	85713		802 070	142651		802 595	143462	
471700003010	89431		481700000477	85900		802 094	142230		802 596	143461	
471700003011	85058	89431	481700000480	85900		802 107	143191		802 598	143460	
471700003011	89431		481700000490	85900		802 143	142249		802 609	143342	
471700003830	85933	89454	481700000493	85900		802 145	143281		802 615	143406	
471700003830	89454		481700125969	85956		802 186	143082		802 657	143366	
471700003832	85933	89454	481700125970	85956		802 196	142653		802 657	143486	
471700003832	89454		481700131438	85919		802 250	143404		802 680	143409	
471700003920	85958		481700131440	85919		802 289	142930		802 680	143410	
471700004420	85109		481700131919	85900		802 291	142625		802 689	143397	
471700004423	85109		481700131920	85900		802 292	143204		802 722	142852	
471700005079	85005	89430	481700999376	85329		802 297	142419		802 739	142546	
471700005079	89430		481700999380	85329		802 298	143367		802 747	142245	
471700005080	89430		481700999386	85376		802 299	142649		802 767	142329	
471700006039	85088		481700999386	85736		802 300	142650		802 780	143209	
471700006040	85088		481700999390	85376		802 304	143492		802 782	142843	
471700006269	85932	89453	510 007	85705	89447	802 306	143201		802 791	143458	
471700006269	89453		510 009	85711		802 346	143465		802 844	142828	
471700006270	85932	89453	510001	85303	89422	802 347	143466		802 849	143197	
471700006270	89453		510001	89422		802 349	143087		802 850	143325	
471700009646	85088		510002	85302	89420	802 358	142937		802 853	142561	
471700009647	85088		510002	89420		802 360	143202		802 854	142836	
471700009650	85088		510003	85004		802 377	142252		802 861	142530	
471700011530	85181		510004	85307		802 379	143191		802 863	143459	
471700011531	85180		510005	85303	89422	802 399	143239		802 885	142938	
471700013186	85109		510005	89422		802 432	143218		802 887	143244	
471700014316	85061	89450	510006	85705	89447	802 435	143418		802 893	142932	
471700014318	85188		510006	89447		802 437	143388		802 895	143256	
471700131155	85918	89449	510017	85323	89436	802 438	143387		802 896	143315	
471700131155	89449		510017	85738		802 444	143491		802 906	143464	
471700131160	85918	89449	510017	89436		802 453	142195		802 909	143423	
471700131160	89449		510018	85724	89443	802 458	143191		802 929	143244	
471700131256	85065		510018	89443		802 458	143365		803 020	143349	
471700131258	85081		510019	85916	89430	802 476	143317		803 022	143305	
471700131260	85081		510019	89430		802 477	143354		803 085	143088	
471700131330	85932	89453	510023	85316	89426	802 478	143355		803 097	143339	
471700131330	89453		510023	89426		802 479	143323		814903003480	83039	
471700131331	85932	89453	553 870	70033		802 486	143416		814903003480	83040	
471700131331	89453		553 871	G56792		802 487	143419		814903003482	83040	
471700131545	85006		554 041	G56802		802 490	143398		814903003483	83039	
471700131646	85918	89449	554 046	G56802		802 492	143455		814903003486	83047	
471700131646	89449		556 271	69420		802 497	143089		814903003496	83009	
471700131650	85918	89449	556 271	69945		802 501	143385		814903003500	83026	
471700131650	89449		556 277	69946		802 502	143324		814903003501	83027	
471700131775	85006		556 882	69863		802 503	143364		814903003528	83038	
471700131778	85331		557 833	G51097		802 504	143369		814903003530	83038	
471700131780	85331		558 301	G51740		802 504	143468		820 690	143477	
471700131920	85933	89454	566 281	G51799		802 513	143408		900 002	143057	

**Important Note:** Competitive Interchanges are to be used for stocking purposes only. Where multiple crosses are identified, please reference the applications section of this catalog. / **Remarque importante:** Les interchanges concurrentiels ne s'utilisent qu'aux fins de stocks. Dans le cas de rferences multiples, consulter la section des applications du catalogue. / **Nota importante:** Dans le cas de rferences multiples, consulter la section des applications du catalogue. / **Nota importante:** Se pueden usar intercambios competitivos para propósitos de almacenamiento solamente. Cuando se identifican intercambios múltiples, consulte la sección de aplicaciones de este catálogo.

**COMPETITIVE & O.E.M. INTERCHANGE LIST**  
**Lista de Intercambios contra Competidores y Equipo Original.**  
**Liste dinterchange de produits compititifs & dquipement original (OEM)**

**SAF Holland**

Saf holland	Gabriel	Upgrade	Saf holland	Gabriel	Upgrade	Saf holland	Gabriel	Upgrade	Saf holland	Gabriel	Upgrade
47170000436	85030	89440	90044081	89436		90045001	85323	89436	90045572	85045	
47170000436	89440		90044086	85000	89436	90045001	89436		90045574	83130	
47170000458	85014		90044086	89436		90045002	85906	89407	90045575	85051	
47170000459	85030	89440	90044089	83124	89407	90045002	89407		90045576	83150	
47170000459	89440		90044089	89407		90045003	85323	89436	90045605	85109	
47170000460	85014		90044089C	83124	89407	90045003	89436		90045607	83150	
47170000460	89414		90044089C	89407		90045040	83130		90045608	83363	
47170000460	89440		90044095	83203	89436	90045053	85908		90045665	85029	
47170000461	89414		90044095	89436		90045054	85051		90045666	83130	
48170000483	89430		90044162	83128	89436	90045075	85911		90045666	85051	
48170000485	89430		90044162	89436		90045083	85910		90045667	85060	
57639	85000	89436	90044448	85051		90045096	85916	89430	90045669	83389	89436
57639	89436		90044625	83125		90045096	89430		90045669	89436	
57643	85013	89414	90044626	83126	89430	90045099	85906	89407	90045803	85109	
57643	89414		90044626	89430		90045099	89407		90045812	85109	
6025	83122	89406	90044642	83127		90045110	83137		90045813	85030	89440
6025	89406		90044679	83122	89406	90045132	85909		90045813	89440	
6026	83204		90044679	89406		90045138	85910		AR-1008	85006	
632155	646177		90044680	83125		90045175	85916	89430	AR-1141	83204	
646201	646177		90044681	83204		90045175	89430		AR-1141-C	83204	
665002	85004		90044682	83209	89414	90045188	85910		AR-1202	85300	89419
665003	85300	89419	90044682	89414		90045207	89405		AR-1202	89419	
665003	89419		90044683	83122	89406	90045277	85030	89440	AR-134-C	85005	89430
665197	85051		90044683	89406		90045277	89440		AR-134-C	89430	
665454	85045		90044684	83124	89407	90045298	83363		AR-1404	85301	
665514	83127		90044684	89407		90045299	83389	89436	AR-1425	85301	
665969	89430		90044685	83389	89436	90045299	89436		AR-1434	83203	89436
671921	85916	89430	90044685	89436		90045331	646155		AR-1434	89436	
671921	89430		90044686	85051		90045336	85014		AR-1654	83209	89414
671922	89405		90044687	83125		90045337	85911		AR-1654	89414	
671923	89440		90044688	83122	89406	90045338	85060		AR-1822	85304	
671931	85916	89430	90044688	89406		90045381	83150		AR-2451	83203	89436
671931	89430		90044769	83207	89407	90045384	85916	89430	AR-2451	89436	
680234	85906	89407	90044769	89407		90045384	89430		AR-2598	83123	89405
680234	89407		90044770	83207	89407	90045418	85916	89430	AR-2598	89405	
680268	85323	89436	90044770	89407		90045418	89430		AR-718-C	83203	89436
680268	89436		90044794	83127		90045419	89405		AR-718-C	89436	
680298	85321		90044833	85052		90045420	89440		AR-718-C-HD	85000	89436
680645	85321		90044834	85052		90045432	85321		AR-718-C-HD	89436	
6898	83125		90044868	85045		90045433	85916	89430	AR-781	83203	89436
90044001	85005	89430	90044878	83635		90045433	89430		AR-781	89436	
90044001	89430		90044907	83635		90045455	85909		AR-958	83207	89407
90044008	85000	89436	90044915	83127		90045466	89406		AR-958	89407	
90044008	89436		90044978	85059		90045471	85078		AR-995	85734	
90044011	85004		90044979	83113		90045500	89430		AR1008	85006	
90044012	85006		90044981	85000	89436	90045503	89430		AR1141	83204	
90044016	85300	89419	90044981	89436		90045504	85030	89440	AR1141C	83204	
90044016	89419		90044982	85000	89436	90045504	89440		AR1202	85300	89419
90044017	83204		90044982	89436		90045532	85030	89440	AR1202	89419	
90044025	83209	89414	90044989	85059		90045532	89440		AR134C	85005	89430
90044025	89414		90044991	85000	89436	90045534	85014		AR134C	89430	
90044046	83123	89405	90044991	89436		90045536	89414		AR1404	85301	
90044046	89405		90044992	85000	89436	90045563	85014		AR1425	85301	
90044071	85000	89436	90044992	89436		90045564	83128	89436	AR1434	83203	89436
90044071	89436		90045000	85906	89407	90045564	89436		AR1434	89436	
90044081	85000	89436	90045000	89407		90045568	85060		AR1654	83209	89414

**Important Note:** Competitive Interchanges are to be used for stocking purposes only. Where multiple crosses are identified, please reference the applications section of this catalog./ **Remarque importante:** Les interchanges concurrentiels ne s'utilisent qu'aux fins de stocks. Dans le cas de rfrences multiples, consulter la section des applications du catalogue./ **Nota importante:** Dans le cas de rfrences multiples, consulter la section des applications du catalogue./ **Nota importante:** Se pueden usar intercambios competitivos para propósitos de almacenamiento solamente. Cuando se identifican intercambios múltiples, consulte la sección de aplicaciones de este catálogo.

**COMPETITIVE & O.E.M. INTERCHANGE LIST**  
**Lista de Intercambios contra Competidores y Equipo Original.**  
**Liste dinterchange de produits comptitifs & dquipement original (OEM)**

**SAF Holland... cont'd**

Saf holland	Gabriel	Upgrade	Saf holland	Gabriel	Upgrade	Saf holland	Gabriel	Upgrade	Saf holland	Gabriel	Upgrade
AR1654	89414		AR2598	89405		AR781	83203	89436	SAF83166SAF	83166	
AR1822	85304		AR718C	83203	89436	AR781	89436		XB-SPN-053-36	83125	
AR2451	83203	89436	AR718C	89436		AR958	83207	89407	XBSPN05336	83125	
AR2451	89436		AR718CHD	85000	89436	AR958	89407				
AR2598	83123	89405	AR718CHD	89436		AR995	85734				

**Safari Motor Coach**

Safari motor coach	Gabriel	Upgrade	Safari motor coach	Gabriel	Upgrade	Safari motor coach	Gabriel	Upgrade	Safari motor coach	Gabriel	Upgrade
B462092	83126	89430	B462092	89430		B462093	89431				
B462092	85910		B462093	85058	89431						

**Seagrave Fire Apparatus LLC**

Seagrave fire apparatus llc	Gabriel	Upgrade	Seagrave fire apparatus llc	Gabriel	Upgrade	Seagrave fire apparatus llc	Gabriel	Upgrade	Seagrave fire apparatus llc	Gabriel	Upgrade
680117	85300	89419	P0025500	85300	89419	P2598000	85712				
680117	89419		P0025500	89419							

**Shasta RV**

Shasta rv	Gabriel	Upgrade	Shasta rv	Gabriel	Upgrade	Shasta rv	Gabriel	Upgrade	Shasta rv	Gabriel	Upgrade
8C24-18045-DA	G63622		8C2Z-18124-D	G63622		ASH-1136	G63623		AT-163G	G63622	
8C24-18080-DB	G63623		8C2Z-18125-D	G63623		ASH-1154	G63622		AT-164G	G63623	
8C2418045DA	G63622		8C2Z18124D	G63622		ASH1136	G63623		AT163G	G63622	
8C2418080DB	G63623		8C2Z18125D	G63623		ASH1154	G63622		AT164G	G63623	

**Sicard**

Sicard	Gabriel	Upgrade	Sicard	Gabriel	Upgrade	Sicard	Gabriel	Upgrade	Sicard	Gabriel	Upgrade
3166657	85700										

**Spartan Motors**

Spartan motors	Gabriel	Upgrade	Spartan motors	Gabriel	Upgrade	Spartan motors	Gabriel	Upgrade	Spartan motors	Gabriel	Upgrade
0272-SS5	85712		2502B46	85013	89414	60665014L	85962		B461725	85029	
0272SS5	85712		2502B46	89414		60665025L	85036	89405	B461725	85910	
0346-SS5	85013	89414	471700000456	85959		60665025L	89405		B461731	85909	
0346-SS5	85030	89440	471700000460	85959		78068	85304		B461732	85030	89440
0346-SS5	89414		58913-009	85959		AS 4025B	85712		B461732	89440	
0346-SS5	89440		58913-009L	85959		B46-1594	85013	89414	B462150	85909	
0346SS5	85013	89414	58913009	85959		B46-1594	85030	89440	B462151	85007	
0346SS5	85030	89440	58913009L	85959		B46-1594	89414		B462151	85030	89440
0346SS5	89414		59011	83214		B46-1594	89440		B462151	89440	
0346SS5	89440		60665-014	85962		B46-1725	85029		B462385	85030	89440
0377-SS5	85029		60665-014L	85962		B46-2151	85007		B462385	89440	
0377SS5	85029		60665-025	85036	89405	B461593	85909		B462502	85013	89414
1300B46	85029		60665-025	89405		B461594	85013	89414	B462502	85030	89440
21310-01	85307		60665-025L	85036	89405	B461594	85030	89440	B462502	89414	
2131001	85307		60665-025L	89405		B461594	89414		B462502	89440	
2200201	85007		60665014	85962		B461594	89440		S2607B	85702	

**Spring Valley**

Spring valley	Gabriel	Upgrade	Spring valley	Gabriel	Upgrade	Spring valley	Gabriel	Upgrade	Spring valley	Gabriel	Upgrade
632155	646177										

**Starcraft Bus Co.**

Starcraft bus co.	Gabriel	Upgrade	Starcraft bus co.	Gabriel	Upgrade	Starcraft bus co.	Gabriel	Upgrade	Starcraft bus co.	Gabriel	Upgrade
3578858C1	85656		4C4Z-18125-DA	85656		ASH-1136	G63623		FC44-18045-BB	85181	
3578858C2	85656		4C4Z18124JB	85928		ASH-1154	G63622		FC44-18080-AB	85180	
3584116C1	83175		4C4Z18124QA	83175		ASH-24658	85181		FC4418045BB	85181	
3584116C2	83175		4C4Z18124RA	85928		ASH-24659	85181		FC4418080AB	85180	
3584118C2	85928		4C4Z18125B	83317		ASH-24660	85180		FC4Z-18124-A	85181	
471700011530	85181		4C4Z18125DA	85656		ASH24658	85181		FC4Z-18124-B	85181	
471700011531	85180		501906C92	83317		ASH24659	85181		FC4Z-18125-A	85180	
4C4Z-18124-JB	85928		AA-616	83175		ASH24660	85180		FC4Z18124A	85181	
4C4Z-18124-QA	83175		AA-617	85928		ASH24661	83317		FC4Z18124B	85181	
4C4Z-18124-RA	85928		AA616	83175		AT-812	85928		FC4Z18125A	85180	
4C4Z-18125-B	83317		AA617	85928		AT812	85928				

**Important Note:** Competitive Interchanges are to be used for stocking purposes only. Where multiple crosses are identified, please reference the applications section of this catalog. / **Remarque importante:** Les interchanges concurrentiels ne s'utilisent qu'aux fins de stocks. Dans le cas de rferences multiples, consulter la section des applications du catalogue. / **Nota importante:** Dans le cas de rferences multiples, consulter la section des applications du catalogue. / **Nota importante:** Se pueden usar intercambios competitivos para propósitos de almacenamiento solamente. Cuando se identifican intercambios múltiples, consulte la sección de aplicaciones de este catálogo.

**COMPETITIVE & O.E.M. INTERCHANGE LIST**  
**Lista de Intercambios contra Competidores y Equipo Original.**  
**Liste dinterchange de produits comptitifs & dquipement original (OEM)**

Starcraft Bus Co.... cont'd

**Stellantis**

Stellantis	Gabriel	Upgrade	Stellantis	Gabriel	Upgrade	Stellantis	Gabriel	Upgrade	Stellantis	Gabriel	Upgrade
0489 5466AC	G51948		478 2732AE	G57071		5170 297AG	G57053		6802 6159AD	G52117	
0489 5467AC	G51947		478 2732AE	G57072		5170 298AG	G57053		6802 6528AD	G52118	
05168284AC	85649		4782 644AD	G57194		5170 298AH	G57053		6802 6529AD	G52117	
05168295AB	85649		4782 644AD	G57195		5171 093AC	143336		6803 3950AB	G52131	
05168296AA	85650		4782 732AE	G57194		5171 122AC	143336		6803 9638AF	G52149	
2174 915AG	G57053		4782 732AE	G57195		5174 300AH	G57053		6803 9639AF	G52148	
2516 009	G63183		4782 733AD	G57194		5174 563AF	G57146		6803 9640AB	G52149	
2516009	G63183		4782 733AD	G57195		5174 915AH	G57053		6803 9640AE	G52149	
2960 707	G63183		4782 734AD	G57194		5174 997AD	G51758		6803 9641AB	G52148	
2960707	G63183		4782 734AD	G57195		518 0998AA	G57071		6803 9641AE	G52148	
2961 043	G63183		4886 509AI	61536		518 0998AA	G57072		6803 9642AF	G52149	
2961043	G63183		489 5747AA	G57071		5180 998AA	G57194		6803 9643AF	G52148	
3633 643	G63183		489 5747AA	G57072		5180 998AA	G57195		6804 0880AG	G64011	
3633 744	G63183		489 5748AB	G57071		52038134	81559		6804 0882AD	G64011	
3633643	G63183		489 5748AB	G57072		52038135	81559		6804 2864AC	G52131	
3633744	G63183		4895 000AE	G55856		52038910	81837		6804 3990AB	G52149	
3638 112	G63183		4895 516AC	G57194		52038912	81837		6804 3991AB	G52148	
3638 631	G63605		4895 516AC	G57195		52038914	81837		6804 6314AB	G57007	
3638112	G63183		4897 412AD	81548		52039302	81560		6804 6314AC	G57007	
3638631	G63605		4897 412AH	61535		52039303	81560		6804 6314AD	G57007	
4036 892	G63605		4897 413AA	81691		5208 7777AF	61536		6804 6318AB	G57007	
4036892	G63605		4897 413AG	81548		5208 777AF	81549		6804 7812AD	G64008	
4443 482	81825		4897 414AG	61535		5208 7948AF	61536		6804 7814AB	G63966	
4656 439AH	69473		4897 414AG	81691		5208 7948AF	81549		6805 3860AA	14040	
4656 449AD	G55896		4897 443AD	81928		5208 8221AG	81926		6805 7374AA	G64043	
4656 612AH	69473		4897 451AA	G55697		5208 8235AE	81926		6805 8866AA	G51842	
4670 468AA	143385		4897 472AD	81919		5208 8654AB	81929		6806 7325AA	G64043	
4684 681AB	81878		4897 567AA	81936		5208 9751AL	61715		6806 7516AF	G63967	
4684 682AB	81878		5014 730AA	81869		52087901	81891		6806 7516AF	G64008	
4684 770	69632		5014 732AG	81869		5210 6928AB	81923		6808 7339AA	G52131	
4684 777	69632		5015 442AD	81836		5210 6955AB	81923		6808 7359AF	G64008	
4684 779	69632		5016 354AB	81836		5210 9912AD	G63844		6808 7362AD	G63967	
4694 773	69632		5066 334AA	G56620		5211 0211AB	81931		6808 7363AC	G63967	
4721 686AE	G64042		5066 336AA	G56620		5211 0214AB	81931		6809 2726AA	G64042	
4721 687AB	G64042		5073 263AC	81932		5272 325AE	G55892		6811 1104AB	85649	
4743 125	G63426		5073 265AC	81932		5272 612AK	G51863		6811 1104AB-001	85649	
4743 127	G63426		5085 461AB	143495		5272 613AL	G51863		6811 1104AB001	85649	
4743 128	G63426		5103 514AC	81933		5272 706AE	G57178		6811 1105AC	85649	
4743 224AA	61605		5105 096AG	G57177		5272 706AH	G57178		6811 1105AC-001	85649	
4743 225AA	61605		5105 097AG	G57176		5285 5333AF	G63892		6811 1105AC001	85649	
4743 229AA	61605		5105 105AF	G57178		5285 5334AD	G63892		6811 1107AA	85650	
4743 413AC	81878		5105 170AF	G57177		6800 1151AB	61720		6811 1107AA-001	85650	
4743 866AD	G51848		5105 170AH	G57177		6800 3952AC	G51728		6811 1107AA001	85650	
4764 523AA	G51267		5105 171AF	G57176		6800 3954AB	G51728		6813 8247AC	G64042	
4766 053AF	G51863		5105 171AH	G57176		6802 6140AD	G52118		6813 8247AE	G64042	
4766 124	G63426		5105 790AL	G51863		6802 6141AD	G52117		6813 8775AB	G64008	
4766 957AD	G51848		5114 318AB	81936		6802 6142AC	G52118		6813 9381AA	61712	
4766 958AD	G51848		5135 538AA	G56620		6802 6142AD	G52118		6814 4549AE	G64042	
478 2643AD	G57194		5135 573AJ	G56807		6802 6143AC	G52117		6814 8548AC	G52149	
478 2643AD	G57195		5161 265AC	G57146		6802 6143AD	G52117		6814 8549AC	G52148	
478 2731AE	G57071		5161 273AC	G57146		6802 6148AD	G52118		6815 5259AC	G57007	
478 2731AE	G57072		5161 274AB	G57146		6802 6149AC	G52117		6815 6980AB	G52131	
478 2731AE	G57194		5166 820AI	G56807		6802 6149AD	G52117		6815 7795AD	G57800	
478 2731AE	G57195		5168 236AB	143336		6802 6158AD	G52118		6815 7795AD	G57801	

**Important Note:** Competitive Interchanges are to be used for stocking purposes only. Where multiple crosses are identified, please reference the applications section of this catalog. / **Remarque importante:** Les interchanges concurrentiels ne s'utilisent qu'aux fins de stocks. Dans le cas de références multiples, consulter la section des applications du catalogue. / **Nota importante:** Dans le cas de références multiples, consulter la section des applications du catalogue. / **Nota importante:** Se pueden usar intercambios competitivos para propósitos de almacenamiento solamente. Cuando se identifican intercambios múltiples, consulte la sección de aplicaciones de este catálogo.

**COMPETITIVE & O.E.M. INTERCHANGE LIST**  
**Lista de Intercambios contra Competidores y Equipo Original.**  
**Liste dinterchange de produits comptitifs & dquipement original (OEM)**

**Stellantis... cont'd**

Stellantis	Gabriel	Upgrade	Stellantis	Gabriel	Upgrade	Stellantis	Gabriel	Upgrade	Stellantis	Gabriel	Upgrade
6817 0198AB	G51856		6822 4858AD	G511038		6827 0280AA	G57801		MB910496	G55820	
6817 0199AB	G51856		6822 4861AD	G511038		G0060043	81834		SG23086	81496	
6818 5556AE	G57800		6823 4553AD	61712		MB109561	G63950		SG23095	69632	
6818 5556AE	G57801		6824 5775AA	G57800		MB111216	G63419		SG23127	81096	
6821 0451AA	G64008		6824 5775AA	G57801		MB242146	81147				
6821 0452AA	G63966		6827 0280AA	G57800		MB515371	81147				

**Sterling Truck**

Sterling truck	Gabriel	Upgrade	Sterling truck	Gabriel	Upgrade	Sterling truck	Gabriel	Upgrade	Sterling truck	Gabriel	Upgrade
05168284AC	85649		57241-2	83109		E7XZ-18124-A	G63386		F5HZ18125B	89410	
05168295AB	85649		572412	83109		E7XZ-18125-B	G63387		F6HT-18045-AA	85054	
05168296AA	85650		58913-003	85932	89453	E7XZ18124A	G63386		F6HT-18045-AC	85054	
10-12388-000	85920	89503	58913-003	89453		E7XZ18125B	G63387		F6HT-18045-BC	85047	89435
10-12388-000	89503		58913-003L	85932	89453	E9HZ-18124-A	83309		F6HT-18045-BC	89435	
10-12390-000	85920	89503	58913-003L	89453		E9HZ18124A	83309		F6HT-18045-CC	85055	89439
10-12390-000	89503		58913003	85932	89453	F0HZ-18124-B	85006		F6HT-18045-CC	89439	
10-13205-000	85918	89449	58913003	89453		F0HZ18124B	85006		F6HT-18045-EB	85055	89439
10-13205-000	89449		58913003L	85932	89453	F1HZ-18124-A	83309		F6HT-18045-EB	89439	
1012388000	85920	89503	58913003L	89453		F1HZ-18124-B	83308		F6HT-18045-EC	85055	89439
1012388000	89503		6803230300	85006		F1HZ-18124-D	85006		F6HT-18045-EC	89439	
1012390000	85920	89503	6803260000	83120		F1HZ-18124-E	85006		F6HT-18045-GB	85030	89440
1012390000	89503		680339	85724	89443	F1HZ-18124-H	85040		F6HT-18045-GB	89440	
1013205000	85918	89449	680339	89443		F1HZ-18124-J	83308		F6HT-18045-GC	85030	89440
1013205000	89449		680611	85724	89443	F1HZ-18124-K	89402		F6HT-18045-GC	89440	
1202-1043	83025		680611	89443		F1HZ18124A	83309		F6HT-18045-HB	85054	
12021043	83025		6811 1104AB	85649		F1HZ18124B	83308		F6HT-18045-HC	85054	
16-13957-000	85724	89443	6811 1104AB-001	85649		F1HZ18124D	85006		F6HT-18045-JB	89402	
16-13957-000	89443		6811 1104AB001	85649		F1HZ18124E	85006		F6HT-18045-JC	89402	
16-15770-000	85956		6811 1105AC	85649		F1HZ18124H	85040		F6HT-18045-KA	89402	
16-15817-000	85724	89443	6811 1105AC-001	85649		F1HZ18124J	83308		F6HT-18045-LA	85376	
16-15817-000	89443		6811 1105AC001	85649		F1HZ18124K	89402		F6HT-18080-B	83109	
1613957000	85724	89443	6811 1107AA	85650		F2HZ-18124-A	85376		F6HT-18080-CA	85314	89425
1613957000	89443		6811 1107AA-001	85650		F2HZ-18124-B	85301		F6HT-18080-CA	89425	
1615770000	85956		6811 1107AA001	85650		F2HZ18124A	85376		F6HT-18080-DA	83109	
1615817000	85724	89443	6E7Z-18125-A	83364		F2HZ18124B	85301		F6HT-18080-EA	85906	89407
1615817000	89443		6E7Z18125A	83364		F4HT-18080-AB	85314	89425	F6HT-18080-EA	89407	
18-45067-000	83034		90045099	85906	89407	F4HT-18080-AB	89425		F6HT-18080-FC	85013	89414
1845067000	83034		90045099	89407		F4HT-18080-BA	85001	89410	F6HT-18080-FC	89414	
471700002810	85724	89443	AT-560	G63809		F4HT-18080-BA	89410		F6HT-18124-JC	89402	
471700002810	89443		AT560	G63809		F4HT18080AB	85314	89425	F6HT-18124-KA	89402	
471700131331	85932	89453	AX-267A	83309		F4HT18080AB	89425		F6HT18045AA	85054	
471700131331	89453		AX-310	83215		F4HT18080BA	85001	89410	F6HT18045AC	85054	
471700131646	85918	89449	AX267A	83309		F4HT18080BA	89410		F6HT18045BC	85047	89435
471700131646	89449		AX310	83215		F5HZ-18124-A	83314		F6HT18045BC	89435	
471700131650	85918	89449	C4HZ-18124-E	83309		F5HZ-18124-B	83107		F6HT18045CC	85055	89439
471700131650	89449		C4HZ18124E	83309		F5HZ-18124-C	85063		F6HT18045CC	89439	
47902-28	85013	89414	C4TZ-18124-AB	83308		F5HZ-18124-D	83125		F6HT18045EB	85055	89439
47902-28	89414		C4TZ18124AB	83308		F5HZ-18125-A	85314	89425	F6HT18045EB	89439	
4790228	85013	89414	D8HZ-18124-A	85301		F5HZ-18125-A	89425		F6HT18045EC	85055	89439
4790228	89414		D8HZ18124A	85301		F5HZ-18125-B	85001	89410	F6HT18045EC	89439	
481700006850	85724	89443	E6HZ-18124-A	85301		F5HZ-18125-B	89410		F6HT18045GB	85030	89440
481700006850	89443		E6HZ-18124-D	85301		F5HZ18124A	83314		F6HT18045GB	89440	
481700125969	85956		E6HZ-18125-D	83215		F5HZ18124B	83107		F6HT18045GC	85030	89440
481700125970	85956		E6HZ18124A	85301		F5HZ18124C	85063		F6HT18045GC	89440	
4C4Z-18124-N	85957		E6HZ18124D	85301		F5HZ18124D	83125				
4C4Z-18125-DA	85656		E6HZ18125D	83215		F5HZ18125A	85314	89425			
4C4Z18124N	85957		E7HZ-18124-A	85301		F5HZ18125A	89425				
4C4Z18125DA	85656		E7HZ18124A	85301		F5HZ18125B	85001	89410			

**Important Note:** Competitive Interchanges are to be used for stocking purposes only. Where multiple crosses are identified, please reference the applications section of this catalog. / **Remarque importante:** Les interchanges concurrentiels ne s'utilisent qu'aux fins de stocks. Dans le cas de rferences multiples, consulter la section des applications du catalogue. / **Nota importante:** Dans le cas de rferences multiples, consulter la section des aplicaciones du catalogue. / **Nota importante:** Se pueden usar intercambios competitivos para propósitos de almacenamiento solamente. Cuando se identifican intercambios múltiples, consulte la sección de aplicaciones de este catálogo.

**COMPETITIVE & O.E.M. INTERCHANGE LIST**  
**Lista de Intercambios contra Competidores y Equipo Original.**  
**Liste dinterchange de produits comptitifs & dquipement original (OEM)**

**Sterling Truck... cont'd**

Sterling truck	Gabriel	Upgrade	Sterling truck	Gabriel	Upgrade	Sterling truck	Gabriel	Upgrade	Sterling truck	Gabriel	Upgrade
F6HT18045HB	85054		F6HT18124KA	89402		F6HZ-18125-D	85013	89414	F6HZ18124J	89402	
F6HT18045HC	85054		F6HZ-18124-A	85054		F6HZ-18125-D	89414		F6HZ18125B	83109	
F6HT18045JB	89402		F6HZ-18124-B	83308		F6HZ-5K407-AB	83034		F6HZ18125D	85013	89414
F6HT18045JC	89402		F6HZ-18124-C	85055	89439	F6HZ18124A	85054		F6HZ18125D	89414	
F6HT18045KA	89402		F6HZ-18124-C	89439		F6HZ18124B	83308		F6HZ5K407AB	83034	
F6HT18045LA	85376		F6HZ-18124-D	85055	89439	F6HZ18124C	85055	89439	F81A-18045-AGB	G63809	
F6HT18080B	83109		F6HZ-18124-D	89439		F6HZ18124C	89439		F81A18045AGB	G63809	
F6HT18080CA	85314	89425	F6HZ-18124-E	85055	89439	F6HZ18124D	85055	89439	XC45-18045-AA	83216	
F6HT18080CA	89425		F6HZ-18124-E	89439		F6HZ18124D	89439		XC45-18080-BA	85724	89443
F6HT18080DA	83109		F6HZ-18124-F	85055	89439	F6HZ18124E	85055	89439	XC45-18080-BA	89443	
F6HT18080EA	85906	89407	F6HZ-18124-F	89439		F6HZ18124E	89439		XC4518045AA	83216	
F6HT18080EA	89407		F6HZ-18124-G	85054		F6HZ18124F	85055	89439	XC4518080BA	85724	89443
F6HT18080FC	85013	89414	F6HZ-18124-H	85054		F6HZ18124F	89439		XC4518080BA	89443	
F6HT18080FC	89414		F6HZ-18124-J	89402		F6HZ18124G	85054				
F6HT18124JC	89402		F6HZ-18125-B	83109		F6HZ18124H	85054				

**Stoughton Trailers Inc.**

Stoughton trailers inc.	Gabriel	Upgrade	Stoughton trailers inc.	Gabriel	Upgrade	Stoughton trailers inc.	Gabriel	Upgrade	Stoughton trailers inc.	Gabriel	Upgrade
HTA20001	83389	89436	HTA20002	89436		NW90044448	85051		RT18165-01	85006	
HTA20001	89436		NW90044162	83128	89436	NW90044978	85059		RT1816501	85006	
HTA20002	85000	89436	NW90044162	89436		NW90044979	83113				

**Suspensions Inc.**

Suspensions inc.	Gabriel	Upgrade	Suspensions inc.	Gabriel	Upgrade	Suspensions inc.	Gabriel	Upgrade	Suspensions inc.	Gabriel	Upgrade
200188	646155										

**Suspensys**

Suspensys	Gabriel	Upgrade	Suspensys	Gabriel	Upgrade	Suspensys	Gabriel	Upgrade	Suspensys	Gabriel	Upgrade
218004872	85737										

**Terex Corp.**

Terex corp.	Gabriel	Upgrade	Terex corp.	Gabriel	Upgrade	Terex corp.	Gabriel	Upgrade	Terex corp.	Gabriel	Upgrade
12111	646155										

**The Binkley Company**

The binkley company	Gabriel	Upgrade	The binkley company	Gabriel	Upgrade	The binkley company	Gabriel	Upgrade	The binkley company	Gabriel	Upgrade
16965	85006		6898	83125							

**Thomas**

Thomas	Gabriel	Upgrade	Thomas	Gabriel	Upgrade	Thomas	Gabriel	Upgrade	Thomas	Gabriel	Upgrade
00614966	85307		3000614966	85307		61310102	85308	89422	6803260000	83120	
10-13211-000	85918	89449	471700131545	85006		61310102	89422		70445	85014	
10-13211-000	89449		471700131550	85006		61310103	85308	89422	728802	85736	
10-13634-000	85918	89449	60670-006	83147		61310103	89422		87002	85736	
10-13634-000	89449		60670-006L	83147		61310104	85713		8C24-18045-DA	G63622	
1013211000	85918	89449	60670006	83147		61310232	85000	89436	8C24-18080-DB	G63623	
1013211000	89449		60670006L	83147		61310232	89436		8C2Z-18124-D	G63622	
1013634000	85918	89449	60998-001	85006		61310434	85724	89443	8C2Z-18125-D	G63623	
1013634000	89449		60998-003	85006		61310434	89443		90045504	85030	89440
128745	83102		60998001	85006		61310478	85724	89443	90045504	89440	
16-15817-000	85724	89443	60998003	85006		61310478	89443		A-4890	85712	
16-15817-000	89443		6130-0114	89437		614974	85304		A4890	85712	
16-18708-000	85724	89443	61300112	83613		63-0001	85713		ASH-1136	G63623	
16-18708-000	89443		61300219	85014		630001	85713		ASH-1154	G63622	
16-19138-000	85058	89431	61300222	85014		651442	83102		AT-163G	G63622	
16-19138-000	89431		61300223	85014		659287	83102		AT-164G	G63623	
1615817000	85724	89443	61300224	85918	89449	680-323-0300	85006		GBL651442	83102	
1615817000	89443		61300224	89449		680-326-0000	83120		GBL654725	83120	
1618708000	85724	89443	61300240	85918	89449	680010	85304		GBL665538	85006	
1618708000	89443		61300240	89449		680054	85307				
1619138000	85058	89431	61300285	83102		680088	85713				
1619138000	89431		6130029	85712		680102	85712				
300-0614966	85307		61310101	85736		6803230300	85006				

**Important Note:** Competitive Interchanges are to be used for stocking purposes only. Where multiple crosses are identified, please reference the applications section of this catalog. / **Remarque importante:** Les interchanges concurrentiels ne s'utilisent qu'aux fins de stocks. Dans le cas de rferences multiples, consulter la section des applications du catalogue. / **Nota importante:** Dans le cas de rferences multiples, consulter la section des applications du catalogue. / **Nota importante:** Se pueden usar intercambios competitivos para propósitos de almacenamiento solamente. Cuando se identifican intercambios múltiples, consulte la sección de aplicaciones de este catálogo.

**COMPETITIVE & O.E.M. INTERCHANGE LIST**  
**Lista de Intercambios contra Competidores y Equipo Original.**  
**Liste dinterchange de produits comptitifs & dquipement original (OEM)**

**Thomas... cont'd**

Thomas	Gabriel	Upgrade	Thomas	Gabriel	Upgrade	Thomas	Gabriel	Upgrade	Thomas	Gabriel	Upgrade
TBB128745	83102										

**Thor Motor Coach**

Thor motor coach	Gabriel	Upgrade	Thor motor coach	Gabriel	Upgrade	Thor motor coach	Gabriel	Upgrade	Thor motor coach	Gabriel	Upgrade
01-205219	85727		12051101	85340		12J571	85733		1616764000	85724	89443
01205219	85727		12051102	85970		12J59	85700		1616764000	89443	
10-13976-000	85918	89449	12051103	85341		12L-4-170	83158		1616873000	85029	
10-13976-000	89449		12051137	85340		12L-5-100	85727		1616874000	83160	
1013976000	85918	89449	12051138	85970		12L-5-114	85727		1618103000	85900	
1013976000	89449		12051139	85341		12L-5-58	85728		19507669	85340	
12-05-1021	85340		12051142	85340		12L-5-67	85728		196013	85340	
12-05-1022	85970		12051146	85340		12L-5-69	85700		1C34-18045-AA	83209	89414
12-05-1023	85341		12051147	85341		12L-5-70	85700		1C34-18045-AA	89414	
12-05-1101	85340		12051148	85970		12L-5-71	85708		1C34-18045-JA	83209	89414
12-05-1102	85970		12051150	85711		12L-5-72	85709		1C34-18045-JA	89414	
12-05-1103	85341		12051165	85711		12L-5-88	85729		1C3418045AA	83209	89414
12-05-1137	85340		12051166	85341		12L-5-89	85729		1C3418045AA	89414	
12-05-1138	85970		12051170	85340		12L-5-96	85728		1C3418045JA	83209	89414
12-05-1139	85341		12051176	85728		12L-5-97	85728		1C3418045JA	89414	
12-05-1142	85340		12051177	85729		12L-5-98	85339		22012067	85700	
12-05-1146	85340		12051178	85339		12L-5-99	85339		22024061	85704	
12-05-1147	85341		12051179	85727		12L4170	83158		22045526	85702	
12-05-1148	85970		12051188	85970		12L5100	85727		22052014	85702	
12-05-1150	85711		12051194	85339		12L5114	85727		3166657	85700	
12-05-1165	85711		12051199	85729		12L558	85728		3178157	85700	
12-05-1166	85341		12051228	85711		12L567	85728		3192333	85700	
12-05-1170	85340		12051242	85728		12L569	85700		481700000490	85900	
12-05-1176	85728		12051243	85729		12L570	85700		481700000493	85900	
12-05-1177	85729		12051244	85727		12L571	85708		63-0127GS	85303	89422
12-05-1178	85339		12051260	85728		12L572	85709		63-0127GS	89422	
12-05-1179	85727		12051261	85729		12L588	85729		630127GS	85303	89422
12-05-1188	85970		12051262	85727		12L589	85729		630127GS	89422	
12-05-1194	85339		12051264	85727		12L596	85728		6314933	85708	
12-05-1199	85729		12051327	85728		12L597	85728		654789	83158	
12-05-1228	85711		12051328	85729		12L598	85339		680232	85733	
12-05-1242	85728		12051329	85727		12L599	85339		680322	85704	
12-05-1243	85729		12056000	85711		12T-1-13	85303	89422	680323	85700	
12-05-1244	85727		12056001	85740		12T-1-13	89422		680333	85708	
12-05-1260	85728		12056002	85339		12T113	85303	89422	680369	85708	
12-05-1261	85729		12056033	85339		12T113	89422		680374	85728	
12-05-1262	85727		12056053	85711		12TA-01-013	85303	89422	680441	85729	
12-05-1264	85727		12056054	85740		12TA-01-013	89422		680452	85339	
12-05-1327	85728		12056055	85339		12TA01013	85303	89422	680462	85728	
12-05-1328	85729		12056068	85727		12TA01013	89422		680470	85713	
12-05-1329	85727		1251G	85700		141700131809	85029		680482	85727	
12-05-6000	85711		1251GS	85700		141700131810	83160		680485	85733	
12-05-6001	85740		12B-5-1-G	85700		1497835	85711		680544	85711	
12-05-6002	85339		12B-5-1-GS	85700		1498200	85740		680546	85339	
12-05-6033	85339		12B51G	85700		1498565	85339		680602	85339	
12-05-6053	85711		12B51GS	85700		16-16736-000	85029		680677	85728	
12-05-6054	85740		12G-5-1	85700		16-16737-000	83160		680680	85729	
12-05-6055	85339		12G51	85700		16-16764-000	85724	89443	680681	85727	
12-05-6068	85727		12J-5-10	85733		16-16764-000	89443		690029	85700	
12-5-1-G	85700		12J-5-10GS	85733		16-16873-000	85029		695125	85704	
12-5-1-GS	85700		12J-5-71	85733		16-16874-000	83160				
12051021	85340		12J-5-9	85700		16-18103-000	85900				
12051022	85970		12J510	85733		1616736000	85029				
12051023	85341		12J510GS	85733		1616737000	83160				

**Important Note:** Competitive Interchanges are to be used for stocking purposes only. Where multiple crosses are identified, please reference the applications section of this catalog. / **Remarque importante:** Les interchanges concurrentiels ne s'utilisent qu'aux fins de stocks. Dans le cas de rferences multiples, consulter la section des applications du catalogue. / **Nota importante:** Dans le cas de rferences multiples, consulter la section des applications du catalogue. / **Nota importante:** Se pueden usar intercambios competitivos para propósitos de almacenamiento solamente. Cuando se identifican intercambios múltiples, consulte la sección de aplicaciones de este catálogo.



**COMPETITIVE & O.E.M. INTERCHANGE LIST**  
**Lista de Intercambios contra Competidores y Equipo Original.**  
**Liste dinterchange de produits comptitifs & dquipement original (OEM)**

**Thor Motor Coach... cont'd**

Thor motor coach	Gabriel	Upgrade	Thor motor coach	Gabriel	Upgrade	Thor motor coach	Gabriel	Upgrade	Thor motor coach	Gabriel	Upgrade
85729	85729		9U9Z18125A	89406		ASH1023	83122	89406	AT-621	89406	
8C24-18045-DA	G63622		ASH-1022	83209	89414	ASH1023	89406		AT-766	83209	89414
8C24-18080-DB	G63623		ASH-1022	89414		ASH1136	G63623		AT-766	89414	
8C2418045DA	G63622		ASH-1023	83122	89406	ASH1154	G63622		AT163G	G63622	
8C2418080DB	G63623		ASH-1023	89406		ASH1161	85006		AT164G	G63623	
8C2Z-18124-D	G63622		ASH-1136	G63623		ASH1162	85005	89430	AT620	83209	89414
8C2Z-18125-D	G63623		ASH-1154	G63622		ASH1162	89430		AT620	89414	
8C2Z18124D	G63622		ASH-1161	85006		ASH1205	83209	89414	AT621	83122	89406
8C2Z18125D	G63623		ASH-1162	85005	89430	ASH1205	89414		AT621	89406	
90-2587	85339		ASH-1162	89430		ASH1206	83122	89406	AT766	83209	89414
97-2201-00151	85700		ASH-1205	83209	89414	ASH1206	89406		AT766	89414	
97-2210-00164	85708		ASH-1205	89414		ASH1228	83209	89414	G1011822	85702	
97-9999-02514	85700		ASH-1206	83122	89406	ASH1228	89414		G1101590	85713	
97-9999-02585	85723		ASH-1206	89406		ASH1229	83209	89414	G1101590GS	85713	
97-9999-02634	85733		ASH-1228	83209	89414	ASH1229	89414		G1201339	85702	
97220100151	85700		ASH-1228	89414		ASH1230	83122	89406	G5008069	85700	
97221000164	85708		ASH-1229	83209	89414	ASH1230	89406		OE10086S	85702	
97999902514	85700		ASH-1229	89414		ASH137	83122	89406	OE10881	85711	
97999902585	85723		ASH-1230	83122	89406	ASH137	89406		OE10882	85740	
97999902634	85733		ASH-1230	89406		ASH25820	85005	89430	OE10883	85339	
9U94-18045-AA	83209	89414	ASH-137	83122	89406	ASH25820	89430		T12-1208	85727	
9U94-18045-AA	89414		ASH-137	89406		ASH25821	85006		T121208	85727	
9U94-18080-AA	83122	89406	ASH-25820	85005	89430	ASH25822	83209	89414	T14-1045GS	85700	
9U94-18080-AA	89406		ASH-25820	89430		ASH25822	89414		T14-1048	85302	89420
9U9418045AA	83209	89414	ASH-25821	85006		ASH25823	83209	89414	T14-1048	89420	
9U9418045AA	89414		ASH-25822	83209	89414	ASH25823	89414		T14-1080	85728	
9U9418080AA	83122	89406	ASH-25822	89414		ASH25824	83122	89406	T14-1081	85729	
9U9418080AA	89406		ASH-25823	83209	89414	ASH25824	89406		T14-1082	85727	
9U9Z-18124-A	83209	89414	ASH-25823	89414		ASH294	83209	89414	T141045GS	85700	
9U9Z-18124-A	89414		ASH-25824	83122	89406	ASH294	89414		T141048	85302	89420
9U9Z-18125-A	83122	89406	ASH-25824	89406		AT-163G	G63622		T141048	89420	
9U9Z-18125-A	89406		ASH-294	83209	89414	AT-164G	G63623		T141080	85728	
9U9Z18124A	83209	89414	ASH-294	89414		AT-620	83209	89414	T141081	85729	
9U9Z18124A	89414		ASH1022	83209	89414	AT-620	89414		T141082	85727	
9U9Z18125A	83122	89406	ASH1022	89414		AT-621	83122	89406			

**Tiffin Motorhomes Inc.**

Tiffin motorhomes inc.	Gabriel	Upgrade	Tiffin motorhomes inc.	Gabriel	Upgrade	Tiffin motorhomes inc.	Gabriel	Upgrade	Tiffin motorhomes inc.	Gabriel	Upgrade
10-13976-000	85918	89449	1013976000	89449		1616764000	85724	89443	58913-009L	85959	
10-13976-000	89449		16-16764-000	85724	89443	1616764000	89443		58913009	85959	
1013976000	85918	89449	16-16764-000	89443		58913-009	85959		58913009L	85959	

**Timbren Industries**

Timbren industries	Gabriel	Upgrade	Timbren industries	Gabriel	Upgrade	Timbren industries	Gabriel	Upgrade	Timbren industries	Gabriel	Upgrade
665804	85939										

**Trailmobile Canada Corp.**

Trailmobile canada corp.	Gabriel	Upgrade	Trailmobile canada corp.	Gabriel	Upgrade	Trailmobile canada corp.	Gabriel	Upgrade	Trailmobile canada corp.	Gabriel	Upgrade
43-4-235	85051		43-6-028	85000	89436	43-8-011	83207	89407	434237	85000	89436
43-4-236	85029		43-6-028	89436		43-8-011	89407		434237	89436	
43-4-237	85000	89436	43-6-118	85000	89436	43-8-013	85000	89436	434239	83207	89407
43-4-237	89436		43-6-118	89436		43-8-013	89436		434239	89407	
43-4-239	83207	89407	43-6-137	85006		43-8-014	85013	89414	434241	85006	
43-4-239	89407		43-6-158	85013	89414	43-8-014	89414		434277	85000	89436
43-4-241	85006		43-6-158	89414		43-8-015	85006		434277	89436	
43-4-277	85000	89436	43-6-164	83207	89407	43-8-022	83225		434278	85059	
43-4-277	89436		43-6-164	89407		43-8-031	85029		434279	83204	
43-4-278	85059		43-8-002	83209	89414	434235	85051		436028	85000	89436
43-4-279	83204		43-8-002	89414		434236	85029		436028	89436	

**Important Note:** Competitive Interchanges are to be used for stocking purposes only. Where multiple crosses are identified, please reference the applications section of this catalog. / **Remarque importante:** Les interchanges concurrentiels ne s'utilisent qu'aux fins de stocks. Dans le cas de rfrences multiples, consulter la section des applications du catalogue. / **Nota importante:** Dans le cas de rfrences multiples, consulter la section des applications du catalogue. / **Nota importante:** Se pueden usar intercambios competitivos para propósitos de almacenamiento solamente. Cuando se identifican intercambios múltiples, consulte la sección de aplicaciones de este catálogo.

# COMPETITIVE & O.E.M. INTERCHANGE LIST

## Lista de Intercambios contra Competidores y Equipo Original.

### Liste dinterchange de produits comptitifs & dquipement original (OEM)

#### Trailmobile Canada Corp.... cont'd

Trailmobile canada corp.	Gabriel	Upgrade	Trailmobile canada corp.	Gabriel	Upgrade	Trailmobile canada corp.	Gabriel	Upgrade	Trailmobile canada corp.	Gabriel	Upgrade
436118	85000	89436	438002	89414		438022	83225		90044992	85000	89436
436118	89436		438011	83207	89407	438031	85029		90044992	89436	
436137	85006		438011	89407		90044089	83124	89407	90045054	85051	
436158	85013	89414	438013	85000	89436	90044089	89407		A-2212	85029	
436158	89414		438013	89436		90044625	83125		A2212	85029	
436164	83207	89407	438014	85013	89414	90044642	83127				
436164	89407		438014	89414		90044978	85059				
438002	83209	89414	438015	85006		90044979	83113				

#### Transportation Mfg. Corp.

Transportation mfg. corp.	Gabriel	Upgrade	Transportation mfg. corp.	Gabriel	Upgrade	Transportation mfg. corp.	Gabriel	Upgrade	Transportation mfg. corp.	Gabriel	Upgrade
12-05-6000	85711		12J-5-9	85700		12T-1-13	85303	89422	1498358	85339	
12-05-6002	85339		12J510	85733		12T-1-13	89422		1509681	85339	
12-05-6033	85339		12J59	85700		12T113	85303	89422	22045526	85702	
12056000	85711		12L-5-69	85700		12T113	89422		22052014	85702	
12056002	85339		12L-5-70	85700		12TA-01-13	85303	89422	680349	85702	
12056033	85339		12L-5-99	85339		12TA-01-13	89422		680470	85713	
12G-5-1	85700		12L569	85700		12TA0113	85303	89422	G1011822	85702	
12G51	85700		12L570	85700		12TA0113	89422		G1101590	85713	
12J-5-10	85733		12L599	85339		1497628	85711				

#### TRIANGLE GROUP

Triangle group	Gabriel	Upgrade	Triangle group	Gabriel	Upgrade	Triangle group	Gabriel	Upgrade	Triangle group	Gabriel	Upgrade
F65101	85062	89408	F65400	85033	89427	F65495	85067	89451	F65528	85069	89455

#### TRP

Trp	Gabriel	Upgrade	Trp	Gabriel	Upgrade	Trp	Gabriel	Upgrade	Trp	Gabriel	Upgrade
89402GSK	89402		89440GSK	89440		HS 85005	89430		HS 85320	85320	89429
89405GSK	89405		89442GSK	89442		HS 85006	85006		HS 85320	89429	
89406GSK	89406		89443GSK	89443		HS 85012	85012	89413	HS 85323	85323	89436
89407GSK	89407		89448GSK	89448		HS 85012	89413		HS 85323	89436	
89408GSK	89408		89449GSK	89449		HS 85029	85029		HS 85724	85724	89443
89409GSK	89409		89450GSK	89450		HS 85033	85033	89427	HS 85724	89443	
89410GSK	89410		89451GSK	89451		HS 85033	89427		HS 85738	85738	
89411GSK	89411		89456GSK	89456		HS 85047	85047	89435	HS 85900	85900	
89413GSK	89413		89459GSK	89459		HS 85047	89435		HS 85918	85918	89449
89414GSK	89414		HS 646155	646155		HS 85052	85052		HS 85918	89449	
89415GSK	89415		HS 727603	83203	89436	HS 85058	85058	89431	HS 85919	85919	
89419GSK	89419		HS 727603	89436		HS 85058	89431		HS 85920	85920	89503
89420GSK	89420		HS 727607	83207	89407	HS 85061	85061	89450	HS 85920	89503	
89422GSK	89422		HS 727607	89407		HS 85062	85062	89408	HS 85924	85924	89457
89423GSK	89423		HS 83008	83008		HS 85062	89408		HS 85924	89457	
89424GSK	89424		HS 83009	83009		HS 85066	85066	89448	HS 85931	85931	89458
89426GSK	89426		HS 83038	83038		HS 85066	89448		HS 85931	89458	
89427GSK	89427		HS 83125	83125		HS 85067	85067	89451	HS 85933	85933	89454
89428GSK	89428		HS 83128	83128	89436	HS 85067	89451		HS 85933	89454	
89429GSK	89429		HS 83128	89436		HS 85069	85069	89455	HS 85934	85934	
89430GSK	89430		HS 83147	83147		HS 85069	89455		HS 85936	85936	89456
89431GSK	89431		HS 83147	83147		HS 85069	89455		HS 85936	89456	
89432GSK	89432		HS 85000	85000	89436	HS 85070	85070	89459	HS 85936	89456	
89432GSK	89432		HS 85000	89436		HS 85070	89459		HS 85938	85938	
89434GSK	89434		HS 85001	85001	89410	HS 85070	89459		HS 85954	85954	
89435GSK	89435		HS 85001	89410		HS 85088	85088		HS 85958	85958	
89436GSK	89436		HS 85001	89410		HS 85310	85310	89423			
89437GSK	89437		HS 85003	85003	89411	HS 85310	89423				
89439GSK	89439		HS 85003	89411		HS 85311	85311	89424			
			HS 85005	85005	89430	HS 85311	89424				

#### Truckmaster

Truckmaster	Gabriel	Upgrade	Truckmaster	Gabriel	Upgrade	Truckmaster	Gabriel	Upgrade	Truckmaster	Gabriel	Upgrade
665632	85013	89414	665633	89427		665784	83122	89406			
665632	89414		665783	83123	89405	665784	89406				
665633	85033	89427	665783	89405							

**Important Note:** Competitive Interchanges are to be used for stocking purposes only. Where multiple crosses are identified, please reference the applications section of this catalog. / **Remarque importante:** Les interchanges concurrentiels ne s'utilisent qu'aux fins de stocks. Dans le cas de rferences multiples, consulter la section des applications du catalogue. / **Nota importante:** Dans le cas de rferences multiples, consultar la seccion de aplicaciones del catalogo. / **Nota importante:** Se pueden usar intercambios competitivos para propósitos de almacenamiento solamente. Cuando se identifican intercambios múltiples, consulte la seccion de aplicaciones de este catalogo.

**COMPETITIVE & O.E.M. INTERCHANGE LIST**  
**Lista de Intercambios contra Competidores y Equipo Original.**  
**Liste dinterchange de produits comptitifs & dquipement original (OEM)**

**Truckmaster... cont'd**

Truckmaster	Gabriel	Upgrade	Truckmaster	Gabriel	Upgrade	Truckmaster	Gabriel	Upgrade	Truckmaster	Gabriel	Upgrade
665785	83137		671052	85070	89459	680242	89422		680348	89413	
665844	85069	89455	671052	89459		680243	85001	89410	680385	85311	89424
665844	89455		671654	85936	89456	680243	89410		680385	89424	
665918	85900		671654	89456		680253	85314	89425	680425	85320	89429
665926	85047	89435	671699	85937		680253	89425		680425	89429	
665926	89435		671794	85067	89451	680261	85062	89408	680435	85033	89427
665927	85901		671794	89451		680261	89408		680435	89427	
665928	85062	89408	680237	85303	89422	680279	83209	89414	680473	85319	89428
665928	89408		680237	89422		680279	89414		680473	89428	
665930	85001	89410	680239	85310	89423	680280	85906	89407	680586	85311	89424
665930	89410		680239	89423		680280	89407		680586	89424	
665931	83312	89409	680240	85302	89420	680281	85003	89411	680601	85012	89413
665931	89409		680240	89420		680281	89411		680601	89413	
665932	85012	89413	680241	85311	89424	680283	85740				
665932	89413		680241	89424		680303	85007				
665950	85902		680242	85308	89422	680348	85012	89413			

**Turtletop Bus**

Turtletop bus	Gabriel	Upgrade	Turtletop bus	Gabriel	Upgrade	Turtletop bus	Gabriel	Upgrade	Turtletop bus	Gabriel	Upgrade
ASH-1136	G63623		ASH-1154	G63622							

**Tuthill Technologies**

Tuthill technologies	Gabriel	Upgrade	Tuthill technologies	Gabriel	Upgrade	Tuthill technologies	Gabriel	Upgrade	Tuthill technologies	Gabriel	Upgrade
1085	83214		17142-01	89410		18164-01	89406		20126-01	89440	
12885-01	85300	89419	1714201	85001	89410	1816401	83122	89406	20129-01	85007	
12885-01	89419		1714201	89410		1816401	89406		2012901	85007	
12885-03	85300	89419	17146-01	83209	89414	18165-01	85006		20960-01	83204	
12885-03	89419		17146-01	89414		1816501	85006		2096001	83204	
1288501	85300	89419	1714601	83209	89414	18166-01	85704		21497-01	85005	89430
1288501	89419		1714601	89414		1816601	85704		21497-01	89430	
1288503	85300	89419	17358-01	83126	89430	18286-01	89414		2149701	85005	89430
1288503	89419		17358-01	89430		18800-01	83203	89436	2149701	89430	
12887-01	85013	89414	1735801	83126	89430	18800-01	89436		23524-01	85738	
12887-01	89414		1735801	89430		1880001	83203	89436	2352401	85738	
12887-02	85013	89414	17403-01	83122	89406	1880001	89436		23553-01	85938	
12887-02	89414		17403-01	89406		19495-01	83126	89430	2355301	85938	
1288701	85013	89414	1740301	83122	89406	19495-01	89430		24392-01	85051	
1288701	89414		1740301	89406		1949501	83126	89430	2439201	85051	
1288702	85013	89414	17408-01	85005	89430	1949501	89430		2697	85712	
1288702	89414		17408-01	89430		19623-01	83123	89405	66502	646155	
16230-01	85702		1740801	85005	89430	19623-01	89405		680162	85300	89419
1623001	85702		1740801	89430		1962301	83123	89405	680162	89419	
16725-01	83126	89430	17794-01	83215		1962301	89405		702135-01	85045	
16725-01	89430		1779401	83215		19824-01	85006		70213501	85045	
1672501	83126	89430	18163-01	83207	89407	1982401	85006		702136-01	85052	
1672501	89430		18163-01	89407		20125-01	85030	89440	70213601	85052	
16824-01	85006		1816301	83207	89407	20125-01	89440		702209-01	85014	
1682401	85006		1816301	89407		2012501	85030	89440	70220901	85014	
17142-01	85001	89410	18164-01	83122	89406	2012501	89440		OE12425	83214	

**Twin Coach**

Twin coach	Gabriel	Upgrade	Twin coach	Gabriel	Upgrade	Twin coach	Gabriel	Upgrade	Twin coach	Gabriel	Upgrade
90044089	83124	89407	90044162	83128	89436	AR-958	83207	89407	AR958	83207	89407
90044089	89407		90044162	89436		AR-958	89407		AR958	89407	
90044089C	83124	89407	AR-718-C-HD	85000	89436	AR718CHD	85000	89436			
90044089C	89407		AR-718-C-HD	89436		AR718CHD	89436				

**UD**

Ud	Gabriel	Upgrade	Ud	Gabriel	Upgrade	Ud	Gabriel	Upgrade	Ud	Gabriel	Upgrade
561000T825	83515		56101-Z5008	83114							
56101-30Z02	G63610		56101-Z5014	83162							

**Important Note:** Competitive Interchanges are to be used for stocking purposes only. Where multiple crosses are identified, please reference the applications section of this catalog. / **Remarque importante:** Les interchanges concurrentiels ne s'utilisent qu'aux fins de stocks. Dans le cas de références multiples, consulter la section des applications du catalogue. / **Nota importante:** Dans le cas de referencias multiples, consultar la sección de aplicaciones del catálogo. / **Nota importante:** Se pueden usar intercambios competitivos para propósitos de almacenamiento solamente. Cuando se identifican intercambios múltiples, consulte la sección de aplicaciones de este catálogo.

**COMPETITIVE & O.E.M. INTERCHANGE LIST**  
**Lista de Intercambios contra Competidores y Equipo Original.**  
**Liste dinterchange de produits comptitifs & dquipement original (OEM)**

**UD... cont'd**

Ud	Gabriel	Upgrade	Ud	Gabriel	Upgrade	Ud	Gabriel	Upgrade	Ud	Gabriel	Upgrade
56101-Z5017	83162		56110-T8123	G63432		56110T8123	G63432		66400	G63432	
56101Z5008	83114		56110-T8129	G63432		56110T8129	G63432		E61000T825	83515	
56101Z5014	83162		56110-Z5008	83114		56110Z5008	83114				
56101Z5017	83162		56110-Z5014	83162		56110Z5014	83162				
56110-30Z02	G63610		56110-Z5017	83162		56110Z5017	83162				

**United Manufacturing**

United manufacturing	Gabriel	Upgrade	United manufacturing	Gabriel	Upgrade	United manufacturing	Gabriel	Upgrade	United manufacturing	Gabriel	Upgrade
K-96-41	85304		K9641	85304							

**Universal Coach**

Universal coach	Gabriel	Upgrade	Universal coach	Gabriel	Upgrade	Universal coach	Gabriel	Upgrade	Universal coach	Gabriel	Upgrade
12-05-1199	85729		12051199	85729		680777	85729				

**UPS Truck**

Ups truck	Gabriel	Upgrade	Ups truck	Gabriel	Upgrade	Ups truck	Gabriel	Upgrade	Ups truck	Gabriel	Upgrade
P117099	83120										

**Utility Trailer Manufacturing Company**

Utility trailer manufacturing company	Gabriel	Upgrade	Utility trailer manufacturing company	Gabriel	Upgrade	Utility trailer manufacturing company	Gabriel	Upgrade	Utility trailer manufacturing company	Gabriel	Upgrade
B-23361	85911		B-24125	85323	89436	B24023	85738		S-24088	83389	89436
B-23566	85000	89436	B-24125	89436		B24088	83389	89436	S-24088	85000	89436
B-23566	89436		B-24579	85939		B24088	85000	89436	S-24088	89436	
B-23651	85045		B-25515	85338		B24088	89436		S24088	83389	89436
B-24023	85738		B23361	85911		B24125	85323	89436	S24088	85000	89436
B-24088	83389	89436	B23566	85000	89436	B24125	89436		S24088	89436	
B-24088	85000	89436	B23566	89436		B24579	85939				
B-24088	89436		B23651	85045		B25515	85338				

**Van Hool**

Van hool	Gabriel	Upgrade	Van hool	Gabriel	Upgrade	Van hool	Gabriel	Upgrade	Van hool	Gabriel	Upgrade
6243-13790	85708		624313790	85708		665562	85708				
6243-14040	85708		624314040	85708		665563	85708				

**Volvo**

Volvo	Gabriel	Upgrade	Volvo	Gabriel	Upgrade	Volvo	Gabriel	Upgrade	Volvo	Gabriel	Upgrade
02-7005976	83400		1091364	89409		1201-0012	83023		20469001	89454	
02-7005977	83400		1091365	83400		12010012	83023		20469002	85933	89454
027005976	83400		1091366	83401		1202-0012	83023		20469002	89454	
027005977	83400		1091367	85000	89436	1202-0032	83016		20485632	85933	89454
03-1106460	85005	89430	1091367	89436		12020012	83023		20485632	89454	
03-1106460	89430		1091368	85003	89411	12020032	83016		20485633	85933	89454
031106460	85005	89430	1091368	89411		141700000370	85061	89450	20485633	89454	
031106460	89430		1091370	85006		141700000370	89450		20496215	83048	
1091347	83125		1091371	85300	89419	141700000373	85061	89450	20496217	83029	
1091348	83122	89406	1091371	89419		141700005838	85061	89450	20513881	85061	89450
1091348	89406		1091372	85301		14QK-429M2	85072		20551628	85066	89448
1091349	83204		1091373	85302	89420	1505190	85722		20551628	89448	
1091350	83207	89407	1091373	89420		1591501	85722		20704334	83048	
1091350	89407		1091374	85303	89422	1593843	83215		20707753	85030	89440
1091351	83209	89414	1091374	89422		1716824	85304		20707753	85906	89407
1091351	89414		1091375	85304		19501669	85339		20707753	89407	
1091353	83215		1091376	85305		19502711	85702		20707753	89440	
1091354	83216		1091377	85307		19506846	85339		20721254	83048	
1091357	83219		1091378	85308	89422	20353932	85081		20782199	85072	
1091358	83456	89447	1091378	89422		20414440	85081		20863239	85080	
1091358	89447		1091379	85310	89423	20433424	85061	89450	20874147	83050	
1091359	83123	89405	1091379	89423		20433425	85066	89448	20973993	85061	89450
1091359	89405		1093100	85027		20433425	89448		21137330	85933	89454
1091360	83303		1093176	85024		20433426	85081				
1091362	83309		1093178	85026		20433427	85065				
1091363	83221		1093180	85030	89440	20434880	85081				
1091364	83312	89409	1093180	89440		20469001	85933	89454			

**Important Note:** Competitive Interchanges are to be used for stocking purposes only. Where multiple crosses are identified, please reference the applications section of this catalog. / **Remarque importante:** Les interchanges concurrentiels ne s'utilisent qu'aux fins de stocks. Dans le cas de rferences multiples, consulter la section des applications du catalogue. / **Nota importante:** Dans le cas de rferences multiples, consulter la section des applications du catalogue. / **Nota importante:** Se pueden usar intercambios competitivos para propósitos de almacenamiento solamente. Cuando se identifican intercambios múltiples, consulte la sección de aplicaciones de este catálogo.

**COMPETITIVE & O.E.M. INTERCHANGE LIST**  
**Lista de Intercambios contra Competidores y Equipo Original.**  
**Liste d'interchange de produits compititifs & d'equpement original (OEM)**

**Volvo... cont'd**

Volvo	Gabriel	Upgrade	Volvo	Gabriel	Upgrade	Volvo	Gabriel	Upgrade	Volvo	Gabriel	Upgrade
21137330	89454		3199946	89427		3199990	85003	89411	373010018	85005	89430
21368411	83905		3199947	85013	89414	3199990	89411		373010018	89430	
21368413	83048		3199947	89414		3199991	85708		373010021	85026	
21391412	83048		3199948	85311	89424	3199992	85733		373013201	85027	
21391413	83048		3199948	89424		3199993	85712		373013202	85026	
21436086	85061	89450	3199949	85310	89423	3199994	85308	89422	3915917	85319	89428
21462378	85088		3199949	89423		3199994	89422		3915917	89428	
21462380	85088		3199950	85023	89415	35901-0001	83209	89414	3915947	85001	89410
22012065	85304		3199950	89415		35901-0001	89414		3915947	89410	
22046483	85304		3199951	85024		35901-0003	85301		3915948	85311	89424
22052336	85304		3199952	85736		35901-0004	83219		3915948	89424	
22314111	85036	89405	3199953	85319	89428	35901-0005	83219		3916352	85013	89414
22314111	89405		3199953	89428		35901-0008	85060		3916352	89414	
22662125	83048		3199954	85003	89411	35901-0011	83123	89405	3919055	85007	
22662224	83048		3199954	89411		35901-0011	89405		3919056	83203	89436
22662230	83905		3199955	85300	89419	35901-0017	83314		3919056	89436	
22662235	83905		3199955	89419		35901-0022	83635		3919057	83225	
22662237	83905		3199956	85036	89405	35901-3201	85024		3919526	83314	
22866844	83048		3199956	89405		35901-3406	85305		3919561	85314	89425
23159761	85188		3199957	83122	89406	35901-3409	85304		3919561	89425	
23159763	85188		3199957	89406		35901-3410	85307		3919565	83103	
23288402	85061	89450	3199959	85323	89436	35901-3413	85006		3919567	83613	
23288403	85061	89450	3199959	89436		35901-3420	85303	89422	3919569	85052	
23567823	85072		3199960	85322		35901-3420	89422		3919570	83128	89436
23568046	85036	89405	3199961	85307		359010001	83209	89414	3919570	89436	
23568046	89405		3199962	85314	89425	359010001	89414		3919571	83635	
25624698	83041		3199962	89425		359010003	85301		3919572	83130	
25624730	85005	89430	3199963	85315		359010004	83219		3919573	83123	89405
25624730	89430		3199965	85736		359010005	83219		3919573	89405	
25625008	83019		3199966	85303	89422	359010008	85060		3919574	85006	
2562558	85060		3199966	89422		359010011	83123	89405	3919575	83120	
3082284	83400		3199967	85302	89420	359010011	89405		3919582	83215	
3092842	85061	89450	3199967	89420		359010017	83314		3919585	83209	89414
31200386	70040		3199968	85308	89422	359010022	83635		3919585	89414	
31200599	143191		3199968	89422		359013201	85024		3919587	83105	
31200754	70040		3199972	85320	89429	359013406	85305		3919588	83216	
31262173	70040		3199972	89429		359013409	85304		3919589	85026	
3130140	85315		3199973	85722		359013410	85307		3919591	83515	
3171696	85307		3199974	85712		359013413	85006		3919592	85024	
3172948	85303	89422	3199975	85700		359013420	85303	89422	3919593	83242	
3172948	89422		3199976	85711		359013420	89422		3919594	85003	89411
3199937	85316	89426	3199977	85711		37001-5	83401		3919594	89411	
3199937	89426		3199978	85712		370015	83401		3919598	83312	89409
3199938	85030	89440	3199979	85702		37301-0001	85013	89414	3919598	89409	
3199938	89440		3199980	85310	89423	37301-0001	89414		3919900	85012	89413
3199939	85058	89431	3199980	89423		37301-0008	83400		3919900	89413	
3199939	89431		3199983	85704		37301-0016	85026		3919901	83103	
3199940	85005	89430	3199984	85314	89425	37301-0018	85005	89430	3919902	83126	89430
3199940	89430		3199984	89425		37301-0018	89430		3919902	89430	
3199941	85006		3199985	85723		37301-0021	85026		3919903	83216	
3199942	89402		3199986	85318		37301-3201	85027		3919904	G63183	
3199943	85012	89413	3199987	85705	89447	37301-3202	85026		3919906	83308	
3199943	89413		3199987	89447		373010001	85013	89414	3919907	83309	
3199944	85006		3199988	85311	89424	373010001	89414		3919909	G63605	
3199945	85027		3199988	89424		373010008	83400		3919910	83221	
3199946	85033	89427	3199989	85709		373010016	85026		3919911	83124	89407

**Important Note:** Competitive Interchanges are to be used for stocking purposes only. Where multiple crosses are identified, please reference the applications section of this catalog. / **Remarque importante:** Les interchanges concurrentiels ne s'utilisent qu'aux fins de stocks. Dans le cas de références multiples, consulter la section des applications du catalogue. / **Nota importante:** Dans le cas de références multiples, consulter la section des applications du catalogue. / **Nota importante:** Se pueden usar intercambios competitivos para propósitos de almacenamiento solamente. Cuando se identifican intercambios múltiples, consulte la sección de aplicaciones de este catálogo.

**COMPETITIVE & O.E.M. INTERCHANGE LIST**  
**Lista de Intercambios contra Competidores y Equipo Original.**  
**Liste dinterchange de produits comptitifs & dquipement original (OEM)**

**Volvo... cont'd**

Volvo	Gabriel	Upgrade	Volvo	Gabriel	Upgrade	Volvo	Gabriel	Upgrade	Volvo	Gabriel	Upgrade
3919911	89407		3919949	89423		3945811	89409		530596	85308	89422
3919912	83215		3919950	83219		3945812	89423		530596	89422	
3919913	83203	89436	3919951	83309		3945813	89428		5322338	83214	
3919913	89436		3919952	85736		3945814	89424		5513989	83216	
3919914	83209	89414	3919953	85319	89428	3945815	89406		5531435	85307	
3919914	89414		3919953	89428		3945816	89430		5531436	85307	
3919915	83127		3919954	85003	89411	3945817	89422		5531437	85307	
3919916	83126	89430	3919954	89411		3945818	89415		5534430	85303	89422
3919916	89430		3919955	85300	89419	3945819	89411		5534430	89422	
3919917	83125		3919955	89419		3945820	89413		5534447	85303	89422
3919918	83401		3919956	85036	89405	3945821	89419		5534447	89422	
3919919	G63625		3919956	89405		3945842	83009		5549899	83207	89407
3919920	83303		3919957	83122	89406	3946210	83103		5549899	89407	
3919921	83123	89405	3919957	89406		3946217	83125		5549925	85304	
3919921	89405		3919958	85046	89434	3946219	83400		5554959	83401	
3919922	83318		3919958	89434		3946239	85724	89443	57241-3	83112	
3919923	83301		3919959	85000	89436	3946239	89443		572413	83112	
3919924	83456	89447	3919959	89436		3949240	85047	89435	60657-007	85072	
3919924	89447		3919960	85322		3949240	89435		60657007	85072	
3919925	83317		3919961	85302	89420	3949241	85061	89450	60675-001	85978	
3919926	G63403		3919961	89420		3953643	85040		60675-001L	85978	
3919927	83101		3919962	85700		3971703	83112		60675-13	85036	89405
3919928	83225		3919964	85304		3972662	85976		60675-13	89405	
3919931	83126	89430	3919965	85702		41700014316	85061	89450	60675001	85978	
3919931	89430		3919966	85736		471700000443	85066	89448	60675001L	85978	
3919932	85062	89408	3919967	85302	89420	471700000443	89448		6067513	85036	89405
3919932	89408		3919967	89420		471700002627	85066	89448	6067513	89405	
3919933	85001	89410	3919968	85736		471700002627	89448		60680-003	83112	
3919933	89410		3919972	85320	89429	471700002630	85066	89448	60680-003L	83112	
3919934	85320	89429	3919972	89429		471700002630	89448		60680-004	83143	
3919934	89429		3919973	85956		471700003830	85933	89454	60680-004L	83143	
3919935	85026		3919974	85712		471700003830	89454		60680-005	83142	
3919936	83207	89407	3919975	85700		471700003832	85933	89454	60680-005L	83142	
3919936	89407		3919976	85033	89427	471700003832	89454		60680003	83112	
3919937	85316	89426	3919976	89427		471700004420	85109		60680003L	83112	
3919937	89426		3919977	85033	89427	471700004423	85109		60680004	83143	
3919938	85030	89440	3919977	89427		471700006038	85088		60680004L	83143	
3919938	89440		3919978	85702		471700006040	85088		60680005	83142	
3919939	85058	89431	3919979	85702		471700013186	85109		60680005L	83142	
3919939	89431		3919980	85702		471700014316	85061	89450	629398	85307	
3919940	85005	89430	3919983	85704		471700014318	85188		629501	85307	
3919940	89430		3919984	85700		471700131256	85065		635869	83004	
3919941	85006		3919985	85723		471700131258	85081		646220	85734	
3919942	89402		3919988	85311	89424	471700131260	85081		64838-001	85933	89454
3919943	85012	89413	3919988	89424		471700131920	85933	89454	64838-001	89454	
3919943	89413		3919989	85709		471700131920	89454		64838-002	85933	89454
3919944	85036	89405	3919990	85003	89411	471700131921	85933	89454	64838-002	89454	
3919944	89405		3919990	89411		471700131921	89454		64838-003	85933	89454
3919945	85027		3919991	85708		47902-24	83137		64838-003	89454	
3919946	85033	89427	3919992	85733		4790224	83137		64838-003L	85933	89454
3919946	89427		3919993	85712		494-660	83219		64838-003L	89454	
3919947	85013	89414	3919994	85310	89423	4940640	83216		64838001	85933	89454
3919947	89414		3919994	89423		494660	83219		64838001	89454	
3919948	85311	89424	3945808	89407		4975479	83400		64838002	85933	89454
3919948	89424		3945809	89410		4975480	83400		64838002	89454	
3919949	85310	89423	3945810	89420		4975549	83216		64838003	85933	89454

**Important Note:** Competitive Interchanges are to be used for stocking purposes only. Where multiple crosses are identified, please reference the applications section of this catalog. / **Remarque importante:** Les interchanges concurrentiels ne s'utilisent qu'aux fins de stocks. Dans le cas de rferences multiples, consulter la section des applications du catalogue. / **Nota importante:** Dans le cas de rferences multiples, consulter la section des applications du catalogue. / **Nota importante:** Se pueden usar intercambios competitivos para propósitos de almacenamiento solamente. Cuando se identifican intercambios múltiples, consulte la sección de aplicaciones de este catálogo.

**COMPETITIVE & O.E.M. INTERCHANGE LIST**  
**Lista de Intercambios contra Competidores y Equipo Original.**  
**Liste dinterchange de produits comptitifs & dquipement original (OEM)**

**Volvo... cont'd**

Volvo	Gabriel	Upgrade	Volvo	Gabriel	Upgrade	Volvo	Gabriel	Upgrade	Volvo	Gabriel	Upgrade
64838003	89454		8169859	85047	89435	83176226	85067	89451	E0HT-18080-AA	83215	
64838003L	85933	89454	8169859	89435		83176226	89451		E0HT18080AA	83215	
64838003L	89454		8174749	85906	89407	83176227	85069	89455	RC SA3041	83041	
66010-0007	83004		8174749	89407		83176227	89455		RC SA3045	83045	
66010-0008	83004		83176191	83019		83176228	85070	89459	RC SA3048	83048	
660100007	83004		83176192	83041		83176228	89459		RC SA3103	83103	
660100008	83004		83176193	83045		83176229	85303	89422	RC SA3111	83111	
662211401	83215		83176194	83048		83176229	89422		RC SA3112	83112	
665410	85027		83176195	83103		83176230	85310	89423	RC SA3124	83124	89407
665539	85026		83176196	83110		83176230	89423		RC SA3124	89407	
665607	85047	89435	83176197	83111		83176231	85311	89424	RC SA3125	83125	
665607	89435		83176198	83112		83176231	89424		RC SA3127	83127	
665623	85046	89434	83176199	83123	89405	83176232	85320	89429	RC SA3128	83128	89436
665623	89434		83176199	89405		83176232	89429		RC SA3128	89436	
665739	85047	89435	83176200	83124	89407	83176233	85321		RC SA3136	83136	
665739	89435		83176200	89407		83176234	85323	89436	RC SA3148	83148	
668302	83216		83176201	83125		83176234	89436		RC SA3203	83203	89436
676081	83401		83176202	83126	89430	83176235	85724	89443	RC SA3203	89436	
676082	83401		83176202	89430		83176235	89443		RC SA3216	83216	
6771501	85040		83176203	83127		83176236	85900		RC SA5000	85000	89436
6772218	85040		83176204	83128	89436	83176237	85916	89430	RC SA5000	89436	
6775411	85040		83176204	89436		83176237	89430		RC SA5001	85001	89410
6775412	85040		83176205	83136		83176238	85918	89449	RC SA5001	89410	
6790756	83215		83176206	83148		83176238	89449		RC SA5003	85003	89411
6794358	85040		83176207	83203	89436	83176239	85933	89454	RC SA5003	89411	
6857668	83105		83176207	89436		83176239	89454		RC SA5005	85005	89430
6876828	83105		83176208	83209	89414	83176240	646155		RC SA5005	89430	
70042	85302	89420	83176208	89414		85104186	85006		RC SA5047	85047	89435
70042	89420		83176209	83215		85104221	85066	89448	RC SA5047	89435	
8026658	85046	89434	83176210	83216		85104221	89448		RC SA5052	85052	
8026658	89434		83176211	85000	89436	85105667	83128	89436	RC SA5061	85061	89450
8056892	85023	89415	83176211	89436		85105667	89436		RC SA5062	85062	89408
8056892	89415		83176212	85001	89410	85106580	85918	89449	RC SA5062	89408	
8060026	85065		83176212	89410		85106580	89449		RC SA5066	85066	89448
8065787	85026		83176213	85003	89411	85107095	83009		RC SA5066	89448	
8071524	85024		83176213	89411		85107238	85976		RC SA5067	85067	89451
8071881	85061	89450	83176214	85005	89430	85134402	85061	89450	RC SA5067	89451	
8073212	85065		83176214	89430		85137234	83125		RC SA5070	85070	89459
8075257	85065		83176215	85023	89415	85137420	85000	89436	RC SA5070	89459	
8075287	85065		83176215	89415		85137420	89436		RC SA5310	85310	89423
8077874	85047	89435	83176216	85026		8667252	G56802		RC SA5310	89423	
8077874	89435		83176217	85033	89427	8667253	G56802		RC SA5320	85320	89429
8077874-P01	85047	89435	83176217	89427		90045132	85906	89407	RC SA5320	89429	
8077874-P01	89435		83176218	85036	89405	90045132	85909		RC SA5724	85724	89443
8077874P01	85047	89435	83176218	89405		90045132	89407		RC SA5724	89443	
8077874P01	89435		83176219	85045		90045605	85109		RC SA5900	85900	
8078195	85061	89450	83176220	85046	89434	90045803	85109		RC SA5918	85918	89449
8078546	83028		83176220	89434		90045812	85109		RC SA5918	89449	
8078547	83029		83176221	85047	89435	ASH-24446	83215		RC SA5933	85933	89454
8083872	85978		83176221	89435		ASH24446	83215		RC SA5933	89454	
8086053	85047	89435	83176222	85052		AX-310	83215		RC SA6155	646155	
8086053	89435		83176223	85061	89450	AX310	83215		SA3019	83019	
8086651	85066	89448	83176224	85062	89408	D7HT-18080-AA	83215		SA3041	83041	
8086651	89448		83176224	89408		D7HT-18080-DA	83215		SA3045	83045	
8162662	83004		83176225	85066	89448	D7HT18080AA	83215		SA3048	83048	
8168617	83030		83176225	89448		D7HT18080DA	83215		SA3103	83103	

**Important Note:** Competitive Interchanges are to be used for stocking purposes only. Where multiple crosses are identified, please reference the applications section of this catalog./ **Remarque importante:** Les interchanges concurrentiels ne s'utilisent qu'aux fins de stocks. Dans le cas de rfrences multiples, consulter la section des applications du catalogue./ **Nota importante:** Dans le cas de rfrences multiples, consultar la section des applications du catalogue./ **Nota importante:** Se pueden usar intercambios competitivos para propósitos de almacenamiento solamente. Cuando se identifican intercambios múltiples, consulte la sección de aplicaciones de este catálogo.



**COMPETITIVE & O.E.M. INTERCHANGE LIST**  
**Lista de Intercambios contra Competidores y Equipo Original.**  
**Liste dinterchange de produits comptitifs & dquipement original (OEM)**

**Volvo... cont'd**

Volvo	Gabriel	Upgrade	Volvo	Gabriel	Upgrade	Volvo	Gabriel	Upgrade	Volvo	Gabriel	Upgrade
SA3110	83110		SA5001	89410		SA5061	85061	89450	SA5320	89429	
SA3111	83111		SA5003	85003	89411	SA5062	85062	89408	SA5321	85321	
SA3112	83112		SA5003	89411		SA5062	89408		SA5323	85323	89436
SA3123	83123	89405	SA5005	85005	89430	SA5066	85066	89448	SA5323	89436	
SA3123	89405		SA5005	89430		SA5066	89448		SA5724	85724	89443
SA3124	83124	89407	SA5023	85023	89415	SA5067	85067	89451	SA5724	89443	
SA3124	89407		SA5023	89415		SA5067	89451		SA5900	85900	
SA3125	83125		SA5026	85026		SA5069	85069	89455	SA5916	85916	89430
SA3126	83126	89430	SA5033	85033	89427	SA5069	89455		SA5916	89430	
SA3126	89430		SA5033	89427		SA5070	85070	89459	SA5918	85918	89449
SA3127	83127		SA5036	85036	89405	SA5070	89459		SA5918	89449	
SA3128	83128	89436	SA5036	89405		SA5303	85303	89422	SA5933	85933	89454
SA3128	89436		SA5045	85045		SA5303	89422		SA5933	89454	
SA3136	83136		SA5046	85046	89434	SA5310	85310	89423	SA6155	646155	
SA3148	83148		SA5046	89434		SA5310	89423		SDA471700131258	85081	
SA5000	85000	89436	SA5047	85047	89435	SA5311	85311	89424			
SA5000	89436		SA5047	89435		SA5311	89424				
SA5001	85001	89410	SA5052	85052		SA5320	85320	89429			

**Volvo RoadChoice**

Volvo roadchoice	Gabriel	Upgrade	Volvo roadchoice	Gabriel	Upgrade	Volvo roadchoice	Gabriel	Upgrade	Volvo roadchoice	Gabriel	Upgrade
SA3008	83008		SA3203	83203	89436	SA5036	89405		SA5311	85311	89424
SA3019	83019		SA3203	89436		SA5045	85045		SA5311	89424	
SA3038	83038		SA3209	83209	89414	SA5046	85046	89434	SA5320	85320	89429
SA3041	83041		SA3209	89414		SA5046	89434		SA5320	89429	
SA3045	83045		SA3215	83215		SA5047	85047	89435	SA5321	85321	
SA3048	83048		SA3216	83216		SA5047	89435		SA5323	85323	89436
SA3066	83066		SA3905	83905		SA5052	85052		SA5323	89436	
SA3103	83103		SA5000	85000	89436	SA5061	85061	89450	SA5724	85724	89443
SA3110	83110		SA5000	89436		SA5062	85062	89408	SA5724	89443	
SA3111	83111		SA5001	85001	89410	SA5062	89408		SA5900	85900	
SA3112	83112		SA5001	89410		SA5066	85066	89448	SA5916	85916	89430
SA3123	83123	89405	SA5003	85003	89411	SA5066	89448		SA5916	89430	
SA3123	89405		SA5003	89411		SA5067	85067	89451	SA5918	85918	89449
SA3124	83124	89407	SA5005	85005	89430	SA5067	89451		SA5918	89449	
SA3124	89407		SA5005	89430		SA5069	85069	89455	SA5931	85931	89458
SA3125	83125		SA5012	85012	89413	SA5069	89455		SA5931	89458	
SA3126	83126	89430	SA5012	89413		SA5070	85070	89459	SA5933	85933	89454
SA3126	89430		SA5023	85023	89415	SA5070	89459		SA5933	89454	
SA3127	83127		SA5023	89415		SA5088	85088		SA5934	85934	
SA3128	83128	89436	SA5026	85026		SA5303	85303	89422	SA5958	85958	
SA3128	89436		SA5033	85033	89427	SA5303	89422		SA6155	646155	
SA3136	83136		SA5033	89427		SA5310	85310	89423	SA83203	83203	89436
SA3148	83148		SA5036	85036	89405	SA5310	89423				

**Wabash National**

Wabash national	Gabriel	Upgrade	Wabash national	Gabriel	Upgrade	Wabash national	Gabriel	Upgrade	Wabash national	Gabriel	Upgrade
202447	85919		FLL85000-071	85000	89436	FRUUCE1295-901	89419		HENS-20002	85000	89436
203447	85919		FLL85000-071	89436		FRUUCE12951	85300	89419	HENS-20002	89436	
DANSR1VJ100	85078		FLL85000071	85000	89436	FRUUCE12951	89419		HENS-20126	85323	89436
FLL83203-071	83203	89436	FLL85000071	89436		FRUUCE1295901	85300	89419	HENS-20126	89436	
FLL83203-071	89436		FLL85030-071	85030	89440	FRUUCE1295901	89419		HENS-21292	85052	
FLL83203071	83203	89436	FLL85030-071	89440		FRUUCE2983-1	85322		HENS-23566	85000	89436
FLL83203071	89436		FLL85030071	85030	89440	FRUUCE29831	85322		HENS-23566	89436	
FLL83207-071	83207	89407	FLL85030071	89440		FRUUCF8339-1	85321		HENS-24088	83389	89436
FLL83207-071	89407		FRUUCE1295-1	85300	89419	FRUUCF83391	85321		HENS-24088	85000	89436
FLL83207071	83207	89407	FRUUCE1295-1	89419		HENS-20001	83389	89436	HENS-24088	89436	
FLL83207071	89407		FRUUCE1295-901	85300	89419	HENS-20001	89436		HENS20001	83389	89436

**Important Note:** Competitive Interchanges are to be used for stocking purposes only. Where multiple crosses are identified, please reference the applications section of this catalog. / **Remarque importante:** Les interchanges concurrentiels ne s'utilisent qu'aux fins de stocks. Dans le cas de références multiples, consulter la section des applications du catalogue. / **Nota importante:** Dans le cas de referencias multiples, consultar la sección de aplicaciones del catálogo. / **Nota importante:** Se pueden usar intercambios competitivos para propósitos de almacenamiento solamente. Cuando se identifican intercambios múltiples, consulte la sección de aplicaciones de este catálogo.

**COMPETITIVE & O.E.M. INTERCHANGE LIST**  
**Lista de Intercambios contra Competidores y Equipo Original.**  
**Liste dinterchange de produits comptitifs & dquipement original (OEM)**

**Wabash National... cont'd**

Wabash national	Gabriel	Upgrade	Wabash national	Gabriel	Upgrade	Wabash national	Gabriel	Upgrade	Wabash national	Gabriel	Upgrade
HENS20001	89436		NEW900-44-089	89407		NEW900-45-054	85051		NEW90044642	83127	
HENS20002	85000	89436	NEW900-44-162	83128	89436	NEW900-45-298	83128	89436	NEW90044794	83127	
HENS20002	89436		NEW900-44-162	89436		NEW900-45-298	89436		NEW90044868	85045	
HENS20126	85323	89436	NEW900-44-625	83125		NEW900-45-299	85000	89436	NEW90044978	85059	
HENS20126	89436		NEW900-44-626	83126	89430	NEW900-45-299	89436		NEW90044979	83113	
HENS21292	85052		NEW900-44-626	89430		NEW90044089	83124	89407	NEW90045040	83130	
HENS23566	85000	89436	NEW900-44-642	83127		NEW90044089	89407		NEW90045054	85051	
HENS23566	89436		NEW900-44-794	83127		NEW90044162	83128	89436	NEW90045298	83363	
HENS24088	83389	89436	NEW900-44-868	85045		NEW90044162	89436		NEW90045299	85000	89436
HENS24088	85000	89436	NEW900-44-978	85059		NEW90044625	83125		NEW90045299	89436	
HENS24088	89436		NEW900-44-979	83113		NEW90044626	83126	89430			
NEW900-44-089	83124	89407	NEW900-45-040	83130		NEW90044626	89430				

**Watson & Chalin Mfg. Inc.**

Watson & chalin mfg. inc.	Gabriel	Upgrade	Watson & chalin mfg. inc.	Gabriel	Upgrade	Watson & chalin mfg. inc.	Gabriel	Upgrade	Watson & chalin mfg. inc.	Gabriel	Upgrade
10147	83203	89436	17186	85323	89436	19603	85939		727603	83203	89436
10147	89436		17186	89436		3946219	83400		727603	89436	
10147HD	85000	89436	17186-01	85323	89436	53000070-001	646177		727604	83204	
10147HD	89436		17186-01	89436		665724	85000	89436	A-20345	85345	
10148	83204		1718601	85323	89436	665724	89436		A20345	85345	
10634	G63357		1718601	89436		665727	85005	89430	B-23649	85064	
11418	646155		17218	85029		665727	89430		B-23650	85052	
11418	646177		17297	85064		665728	85060		B-23651	85045	
11604	83125		17300	85052		665769	85052		B-23743	85938	
11724	83123	89405	17306	85938		665770	85064		B23649	85064	
11724	89405		17382	85014		665862	85000	89436	B23650	85052	
12128	85005	89430	17430	85321		665862	89436		B23651	85045	
12128	89430		17474	85009		680547	85323	89436	B23743	85938	
17069	632147		19036	85934		680547	89436				
17079	85300	89419	19249	85939		680584	85938				
17079	89419		19250	85382		680714	85934				

**Western Star**

Western star	Gabriel	Upgrade	Western star	Gabriel	Upgrade	Western star	Gabriel	Upgrade	Western star	Gabriel	Upgrade
02-7005976	83400		16-18708-000	85724	89443	350664413	83122	89406	37301-3405	89442	
02-7005977	83400		16-18708-000	89443		350664413	89406		37301-3409	85053	89442
027005976	83400		1615770000	85956		35901-0001	83209	89414	37301-3409	89442	
027005977	83400		1615817000	85724	89443	35901-0001	89414		37301-3412	85053	89442
04-9041375	85315		1615817000	89443		35901-3406	85305		37301-3412	89442	
049041375	85315		1618331000	85053	89442	35901-3409	85304		373013401	85053	89442
10-13684-000	85918	89449	1618331000	89442		35901-3410	85307		373013401	89442	
10-13684-000	89449		1618706000	85331		35901-3413	85006		373013404	85053	89442
10-13809-000	85958		1618708000	85724	89443	35901-3420	85303	89422	373013404	89442	
1011839	83216		1618708000	89443		35901-3420	89422		373013405	85053	89442
1013684000	85918	89449	16725-01	83126	89430	35901-4403	85060		373013405	89442	
1013684000	89449		16725-01	89430		359010001	83209	89414	373013409	85053	89442
1013809000	85958		1672501	83126	89430	359010001	89414		373013409	89442	
1201-0012	83023		1672501	89430		359013406	85305		373013412	85053	89442
12010012	83023		18-60772-000	83026		359013409	85304		373013412	89442	
1202-0012	83023		18-60773-000	83027		359013410	85307		37390-4401	85053	89442
1202-0032	83016		1860772000	83026		359013413	85006		37390-4401	89442	
12020012	83023		1860773000	83027		359013420	85303	89422	37390-4402	85053	89442
12020032	83016		19495-01	83126	89430	359013420	89422		37390-4402	89442	
16-15770-000	85956		19495-01	89430		359014403	85060		37390-4403	85053	89442
16-15817-000	85724	89443	1949501	83126	89430	37301-3401	85053	89442	37390-4403	89442	
16-15817-000	89443		1949501	89430		37301-3401	89442				
16-18331-000	85053	89442	28R010	83216		37301-3404	85053	89442			
16-18331-000	89442		35066-4413	83122	89406	37301-3404	89442				
16-18706-000	85331		35066-4413	89406		37301-3405	85053	89442			

**Important Note:** Competitive Interchanges are to be used for stocking purposes only. Where multiple crosses are identified, please reference the applications section of this catalog. / **Remarque importante:** Les interchanges concurrentiels ne s'utilisent qu'aux fins de stocks. Dans le cas de rferences multiples, consulter la section des applications du catalogue. / **Nota importante:** Dans le cas de rferences multiples, consultar la section des aplicaciones du catalogue. / **Nota importante:** Se pueden usar intercambios competitivos para propósitos de almacenamiento solamente. Cuando se identifican intercambios múltiples, consulte la sección de aplicaciones de este catálogo.

# COMPETITIVE & O.E.M. INTERCHANGE LIST

## Lista de Intercambios contra Competidores y Equipo Original.

### Liste d'interchange de produits compétitifs & d'équipement original (OEM)

#### Western Star... cont'd

Western star	Gabriel	Upgrade	Western star	Gabriel	Upgrade	Western star	Gabriel	Upgrade	Western star	Gabriel	Upgrade
373904401	85053	89442	4790213	89406		58913012L	85932	89453	66010-3407	83065	
373904401	89442		4790224	83137		58913012L	89453		660103402	83022	
373904402	85053	89442	479028	83122	89406	60657-003	85072		660103403	83022	
373904402	89442		479028	89406		60657-003L	85072		660103404	83022	
373904403	85053	89442	481700006848	85724	89443	60657003	85072		660103405	83026	
373904403	89442		481700006848	89443		60657003L	85072		660103406	83027	
471700000470	85918	89449	481700125969	85956		60675-002	85979		660103407	83065	
471700000470	89449		481700125970	85956		60675-002L	85979		665682	85053	89442
471700002809	85724	89443	57241-1	83111		60675002	85979		665682	89442	
471700002809	89443		572411	83111		60675002L	85979		676081	83401	
471700002810	85724	89443	57252	85308	89422	60680-003	83112		676082	83401	
471700002810	89443		57252	89422		60680-003L	83112		680611	85724	89443
471700003920	85958		57905-1	85976		60680-004	83143		680611	89443	
471700004420	85109		57905-2	85006		60680-004L	83143		81-4903003500	83026	
471700004423	85109		579051	85976		60680-005	83142		814903003500	83026	
471700006269	85932	89453	579052	85006		60680-005L	83142		814903003501	83027	
471700006269	89453		58913-003	85932	89453	60680003	83112		90044025	83209	89414
471700006270	85932	89453	58913-003	89453		60680003L	83112		90044025	89414	
471700006270	89453		58913-003L	85932	89453	60680004	83143		90044907	83635	
471700013186	85109		58913-003L	89453		60680004L	83143		90045099	85906	89407
471700131330	85932	89453	58913-012	85932	89453	60680005	83142		90045099	89407	
471700131330	89453		58913-012	89453		60680005L	83142		90045605	85109	
471700131331	85932	89453	58913-012L	85932	89453	615016	83401		90045803	85109	
471700131331	89453		58913-012L	89453		617547	83022		90045812	85109	
47902-13	83122	89406	58913003	85932	89453	654846	83027		CP-5222	85315	
47902-13	89406		58913003	89453		66010-3402	83022		CP5222	85315	
47902-24	83137		58913003L	85932	89453	66010-3403	83022		GBL 654916	83026	
47902-8	83122	89406	58913003L	89453		66010-3404	83022		SDA471700002809	85724	89443
47902-8	89406		58913012	85932	89453	66010-3405	83026		SDA471700002809	89443	
4790213	83122	89406	58913012	89453		66010-3406	83027		SDA481700125969	85956	

#### Western Unit Stabiliaire Suspension

Western unit stabiliaire suspension	Gabriel	Upgrade	Western unit stabiliaire suspension	Gabriel	Upgrade	Western unit stabiliaire suspension	Gabriel	Upgrade	Western unit stabiliaire suspension	Gabriel	Upgrade
101030	85307		4939967	85308	89422	80370	85304		80600	89419	
101364	85305		4939967	89422		80600	85300	89419			

#### Westport Axle Corp.

Westport axle corp.	Gabriel	Upgrade	Westport axle corp.	Gabriel	Upgrade	Westport axle corp.	Gabriel	Upgrade	Westport axle corp.	Gabriel	Upgrade
143699-0185	646177		646124	646177							

#### Wheeled Coach Ind.

Wheeled coach ind.	Gabriel	Upgrade	Wheeled coach ind.	Gabriel	Upgrade	Wheeled coach ind.	Gabriel	Upgrade	Wheeled coach ind.	Gabriel	Upgrade
ASH-1136	G63623		ASH-1154	G63622		ASH1136	G63623		ASH1154	G63622	

#### Winnebago

Winnebago	Gabriel	Upgrade	Winnebago	Gabriel	Upgrade	Winnebago	Gabriel	Upgrade	Winnebago	Gabriel	Upgrade
141700131809	85029		1C34-18045-JA	89414		66153002	83124	89407	9U9418045AA	83209	89414
141700131810	83160		1C3418045AA	83209	89414	66153002	89407		9U9418045AA	89414	
16-16736-000	85029		1C3418045AA	89414		8C24-18045-DA	G63622		9U9418080AA	83122	89406
16-16737-000	83160		1C3418045JA	83209	89414	8C24-18080-DB	G63623		9U9418080AA	89406	
16-16873-000	85029		1C3418045JA	89414		8C2418045DA	G63622		9U9Z-18124-A	83209	89414
16-16874-000	83160		24-153249	85125		8C2418080DB	G63623		9U9Z-18124-A	89414	
16-18103-000	85900		24-153256	85124		8C2Z-18124-D	G63622		9U9Z-18125-A	83122	89406
1616736000	85029		24-186629	85125		8C2Z-18125-D	G63623		9U9Z-18125-A	89406	
1616737000	83160		24153249	85125		8C2Z18124D	G63622		9U9Z-18125-B	83122	89406
1616873000	85029		24153256	85124		8C2Z18125D	G63623		9U9Z-18125-B	89406	
1616874000	83160		24186629	85125		90045455	85909		9U9Z18124A	83209	89414
1618103000	85900		481700000490	85900		9U94-18045-AA	83209	89414			
1C34-18045-AA	83209	89414	481700000493	85900		9U94-18045-AA	89414				
1C34-18045-AA	89414		66153-002	83124	89407	9U94-18080-AA	83122	89406			
1C34-18045-JA	83209	89414	66153-002	89407		9U94-18080-AA	89406				

**Important Note:** Competitive Interchanges are to be used for stocking purposes only. Where multiple crosses are identified, please reference the applications section of this catalog. / **Remarque importante:** Les interchanges concurrentiels ne s'utilisent qu'aux fins de stocks. Dans le cas de références multiples, consulter la section des applications du catalogue. / **Nota importante:** Dans le cas de referencias multiples, consultar la sección de aplicaciones del catálogo. / **Nota importante:** Se pueden usar intercambios competitivos para propósitos de almacenamiento solamente. Cuando se identifican intercambios múltiples, consulte la sección de aplicaciones de este catálogo.

**COMPETITIVE & O.E.M. INTERCHANGE LIST**  
**Lista de Intercambios contra Competidores y Equipo Original.**  
**Liste dinterchange de produits comptitifs & dquipement original (OEM)**

**Winnebago... cont'd**

Winnebago	Gabriel	Upgrade	Winnebago	Gabriel	Upgrade	Winnebago	Gabriel	Upgrade	Winnebago	Gabriel	Upgrade
9U9Z18124A	89414		ASH-25820	85005	89430	ASH1229	83209	89414	AT164G	G63623	
9U9Z18125A	83122	89406	ASH-25820	89430		ASH1229	89414		AT620	83209	89414
9U9Z18125A	89406		ASH-25821	85006		ASH1230	83122	89406	AT620	89414	
9U9Z18125B	83122	89406	ASH-25822	83209	89414	ASH1230	89406		AT621	83122	89406
9U9Z18125B	89406		ASH-25822	89414		ASH137	83122	89406	AT621	89406	
ASH-1022	83209	89414	ASH-25823	83209	89414	ASH137	89406		AT766	83209	89414
ASH-1022	89414		ASH-25823	89414		ASH25820	85005	89430	AT766	89414	
ASH-1023	83122	89406	ASH-25824	83122	89406	ASH25820	89430		F4-BE5-A832-MO	85125	
ASH-1023	89406		ASH-25824	89406		ASH25821	85006		F4-BE5-B492-HO	85125	
ASH-1136	G63623		ASH-294	83209	89414	ASH25822	83209	89414	F4-BE5-C832-MO	83124	89407
ASH-1154	G63622		ASH-294	89414		ASH25822	89414		F4-BE5-C832-MO	89407	
ASH-1161	85006		ASH1022	83209	89414	ASH25823	83209	89414	F4-BE5-F324-HO	85125	
ASH-1162	85005	89430	ASH1022	89414		ASH25823	89414		F4-BE5-F325-HO	85124	
ASH-1162	89430		ASH1023	83122	89406	ASH25824	83122	89406	F4BE5A832MO	85125	
ASH-1205	83209	89414	ASH1023	89406		ASH25824	89406		F4BE5B492HO	85125	
ASH-1205	89414		ASH1136	G63623		ASH294	83209	89414	F4BE5C832MO	83124	89407
ASH-1206	83122	89406	ASH1154	G63622		ASH294	89414		F4BE5C832MO	89407	
ASH-1206	89406		ASH1161	85006		AT-163G	G63622		F4BE5F324HO	85125	
ASH-1228	83209	89414	ASH1162	85005	89430	AT-164G	G63623		F4BE5F325HO	85124	
ASH-1228	89414		ASH1162	89430		AT-620	83209	89414	HU9Z-18125-B	83122	89406
ASH-1229	83209	89414	ASH1205	83209	89414	AT-620	89414		HU9Z-18125-B	89406	
ASH-1229	89414		ASH1205	89414		AT-621	83122	89406	HU9Z18125B	83122	89406
ASH-1230	83122	89406	ASH1206	83122	89406	AT-621	89406		HU9Z18125B	89406	
ASH-1230	89406		ASH1206	89406		AT-766	83209	89414	W0005662	85125	
ASH-137	83122	89406	ASH1228	83209	89414	AT-766	89414		W0005663	85124	
ASH-137	89406		ASH1228	89414		AT163G	G63622		W0006254	85125	

**Workhorse**

Workhorse	Gabriel	Upgrade	Workhorse	Gabriel	Upgrade	Workhorse	Gabriel	Upgrade	Workhorse	Gabriel	Upgrade
24-153249	85125		66153-002	89407		F4-BE5-C832-MO	83124	89407	F4BE5F324HO	85125	
24-153256	85124		66153002	83124	89407	F4-BE5-C832-MO	89407		F4BE5F325HO	85124	
24-186629	85125		66153002	89407		F4-BE5-F324-HO	85125		W0005662	85125	
24153249	85125		680672	85919		F4-BE5-F325-HO	85124		W0005663	85124	
24153256	85124		7805-X-1012	85919		F4BE5A832MO	85125		W0006254	85125	
24186629	85125		7805X1012	85919		F4BE5B492HO	85125		W0007365	G63866	
659223	G63866		F4-BE5-A832-MO	85125		F4BE5C832MO	83124	89407	W0011635	83221	
66153-002	83124	89407	F4-BE5-B492-HO	85125		F4BE5C832MO	89407		W0011636	G63366	

**World Trans Bus Co.**

World trans bus co.	Gabriel	Upgrade	World trans bus co.	Gabriel	Upgrade	World trans bus co.	Gabriel	Upgrade	World trans bus co.	Gabriel	Upgrade
ASH-1136	G63623		ASH-1154	G63622		ASH1136	G63623		ASH1154	G63622	

**XOS Truck Company**

Xos truck company	Gabriel	Upgrade	Xos truck company	Gabriel	Upgrade	Xos truck company	Gabriel	Upgrade	Xos truck company	Gabriel	Upgrade
58913-009	85959		58913009L	85959		60665-025L	85036	89405	60665025	89405	
58913-009L	85959		60665-025	85036	89405	60665-025L	89405		60665025L	85036	89405
58913009	85959		60665-025	89405		60665025	85036	89405	60665025L	89405	

**ZF**

Zf	Gabriel	Upgrade	Zf	Gabriel	Upgrade	Zf	Gabriel	Upgrade	Zf	Gabriel	Upgrade
SAC315390	85918	89449	SAC315435	85088		SAC315606	85061	89450	SAC410056	83389	89436
SAC315395	85724	89443	SAC315542	83122	89406	SAC315608	85061	89450			

**Important Note:** Competitive Interchanges are to be used for stocking purposes only. Where multiple crosses are identified, please reference the applications section of this catalog./ **Remarque importante:** Les interchanges concurrentiels ne s'utilisent qu'aux fins de stocks. Dans le cas de rferences multiples, consulter la section des applications du catalogue./ **Nota importante:** Dans le cas de rferences multiples, consulter la section des applications du catalogue./ **Nota importante:** Se pueden usar intercambios competitivos para propósitos de almacenamiento solamente. Cuando se identifican intercambios múltiples, consulte la sección de aplicaciones de este catálogo.



# FleetLine® GasSLX®

## Interchange

Intercambio  
Échange

FleetLine	GasSLX	FleetLine	GasSLX
83123	89405	85058	89431
85036	89405	85046	89434
83122	89406	85047	89435
83124	89407	83128	89436
83207	89407	83203	89436
85906	89407	83389	89436
85062	89408	85000	89436
83312	89409	85323	89436
85001	89410	85055	89439
85003	89411	85030	89440
85012	89413	85053	89442
83209	89414	85724	89443
85013	89414	83456	89447
85023	89415	85705	89447
85300	89419	85066	89448
85302	89420	85918	89449
85303	89422	85061	89450
85308	89422	85067	89451
85310	89423	85932	89453
85311	89424	85933	89454
85314	89425	85069	89455
85316	89426	85936	89456
85033	89427	85924	89457
85319	89428	85923	89458
85320	89429	85931	89458
83126	89430	85070	89459
85005	89430	85084	89460
85916	89430	85920	89503



**IMPORTANT NOTE:** Interchange must only be used for FLEETLINE to GasSLX upgrade. Interchange is **NOT REVERSIBLE**.

**NOTA IMPORTANTE:** El intercambio se debe utilizar solamente de FLEETLINE a GasSLX mejorado. El intercambio **NO ES REVERSIBLE**.

**REMARQUE IMPORTANTE:** L'échange ne peut se faire que pour le surclassement du FLEETLINE au GasSLX. L'échange **N'EST PAS REVERSIBLE**.



# HOW TO DETERMINE THE CORRECT SHOCK FOR YOUR TRUCK

## CÓMO ESCOGER EL MEJOR AMORTIGUADOR PARA SU CAMIÓN

### COMMENT CHOISIR LE BON AMORTISSEUR POUR VOTRE CAMION

**Part Number:** The catalog number for the individual shock absorber.

**Extended Length\*:** The length of the shock absorber when it is fully extended. See "How to Measure" instructions.

**Collapsed Length\*:** The length of the shock absorber when it is fully collapsed. See "How to Measure" instructions

**Stroke:** This is the approximate length of the stroke of the individual shock absorber being described.

**Mounting Codes:** Indicates the type of mounting ends for the upper and lower end of each shock absorber.

They are listed as follows:

- Stud type mounts ("S" & "DS")
- Eye ring and bushing mounts ("EB")
- Eye ring and bushing with sleeve mounts ("ES")
- Eye ring and bushing with bar pin mounts ("BP")
- Special mounting codes ("SP")

**Número de parte:** El número de catálogo para el amortiguador individual.

**Longitud extendida\*:** La longitud del amortiguador cuando está totalmente extendido. Consulte las instrucciones "Cómo medir".

**Longitud colapsada\*:** La longitud del amortiguador cuando está totalmente colapsado. Consulte las instrucciones "Cómo medir".

**Carrera:** Esta es la longitud aproximada de la carrera del amortiguador individual que se está describiendo.

**Códigos de montura:** Indica el tipo de extremos de montura para el extremo superior e inferior de cada amortiguador.

Se enumeran de la siguiente manera:

- Monturas tipo perno ("S" y "DS")
- Monturas de anillo y casquillo ("EB")
- Monturas de anillo y casquillo con funda ("ES")
- Monturas de anillo y casquillo con pasador de barra ("BP")
- Códigos especiales de montura ("SP")

**Numéro de pièce :** Le numéro de catalogue pour l'amortisseur individuel.

**Longueur en extension\*:** La longueur de l'amortisseur lorsqu'il est en extension complète. Voir les instructions « Comment mesurer ».

**Longueur plié\*:** La longueur de l'amortisseur lorsqu'il est complètement plié. Voir les instructions « Comment mesurer ».

**Course:** Ceci est la longueur approximative de la course de l'amortisseur individuel décrit ici.

**Codes de fixation:** Indique le type d'extrémité de fixation pour l'extrémité supérieure et inférieure de chaque amortisseur.

Ils sont classés comme suit :

- Fixations à goujons (« S » et « DS »)
- Fixations à œillet et à douille (« EB »)
- Fixations à œillet et douille de glissement (« ES »)
- Fixations à œillet et à douille avec broche (« BP »)
- Codes de fixations spéciales (« SP »)

#### CONVERSION CHART | TABLA DE CONVERSIÓN | TABLEAU DE CONVERSION

Fraction   Fracción	Decimal   Décimal	Metric   Métrico   Métrique	Fraction   Fracción	Decimal   Décimal	Metric   Métrico   Métrique
(INCHES)	(INCHES)	(MM)	(INCHES)	(INCHES)	(MM)
1/64	0.016	0.397	33/64	0.516	13.097
1/32	0.031	0.794	17/32	0.531	13.494
3/64	0.047	1.191	35/64	0.547	13.891
1/16	0.063	1.588	9/16	0.563	14.288
5/64	0.078	1.984	37/64	0.578	14.684
3/32	0.094	2.381	19/32	0.594	15.081
7/64	0.109	2.778	39/64	0.609	15.478
1/8	0.125	3.175	5/8	0.625	15.875
9/64	0.141	3.572	41/64	0.641	16.272
5/32	0.156	3.969	21/32	0.656	16.669
11/64	0.172	4.366	43/64	0.672	17.066
3/16	0.188	4.763	11/16	0.688	17.463
13/64	0.203	5.159	45/64	0.703	17.859
7/32	0.219	5.556	23/32	0.719	18.256
15/64	0.234	5.953	47/64	0.734	18.653
1/4	0.250	6.350	3/4	0.750	19.050
17/64	0.266	6.747	49/64	0.766	19.447
9/32	0.281	7.144	25/32	0.781	19.844
19/64	0.297	7.541	51/64	0.797	20.241
5/16	0.313	7.938	13/16	0.813	20.638
21/64	0.328	8.334	53/64	0.828	21.034
11/32	0.344	8.731	27/32	0.844	21.431
23/64	0.359	9.128	55/64	0.859	21.828
3/8	0.375	9.525	7/8	0.875	22.225
25/64	0.391	9.922	57/64	0.891	22.622
13/32	0.406	10.319	29/32	0.906	23.019
27/64	0.422	10.716	59/64	0.922	23.416
7/16	0.438	11.113	15/16	0.938	23.813
29/64	0.453	11.509	61/64	0.953	24.209
15/32	0.469	11.906	31/32	0.969	24.606
31/64	0.484	12.303	63/64	0.984	25.003
1/2	0.500	12.700	1	1.000	25.400

#### METRIC CONVERSION CHART | TABLA DE CONVERSIÓN MÉTRICA | TABLEAU DE CONVERSION

(MM)	(INCHES)	(MM)	(INCHES)	(MM)	(INCHES)
1	0.03937	10	0.39370	19	0.74803
2	0.07874	11	0.43307	20	0.78740
3	0.11811	12	0.47244	21	0.82677
4	0.15748	13	0.51181	22	0.86614
5	0.19685	14	0.55118	23	0.90551
6	0.23622	15	0.59055	24	0.94488
7	0.27559	16	0.62992	25	0.98425
8	0.31496	17	0.66929		
9	0.35433	18	0.70866		

# HOW TO DETERMINE THE CORRECT SHOCK FOR YOUR TRUCK

## CÓMO ESCOGER EL MEJOR AMORTIGUADOR PARA SU CAMIÓN

## COMMENT CHOISIR LE BON AMORTISSEUR POUR VOTRE CAMION

**STEP 1:** Measure the diameter of the dust tube and cylinder to determine the series.

**1<sup>ER</sup> PASO:** Mida el diámetro del tubo de polvo y del cilindro para determinar la serie.

**1<sup>RE</sup> ÉTAPE:** Mesurez le diamètre du tube de poussière et du cylindre pour déterminer la série.

### EXTERNAL DIMENSIONS

### DIMENSIONES EXTERNAS

### DIMENSIONS EXTÉRIEURES

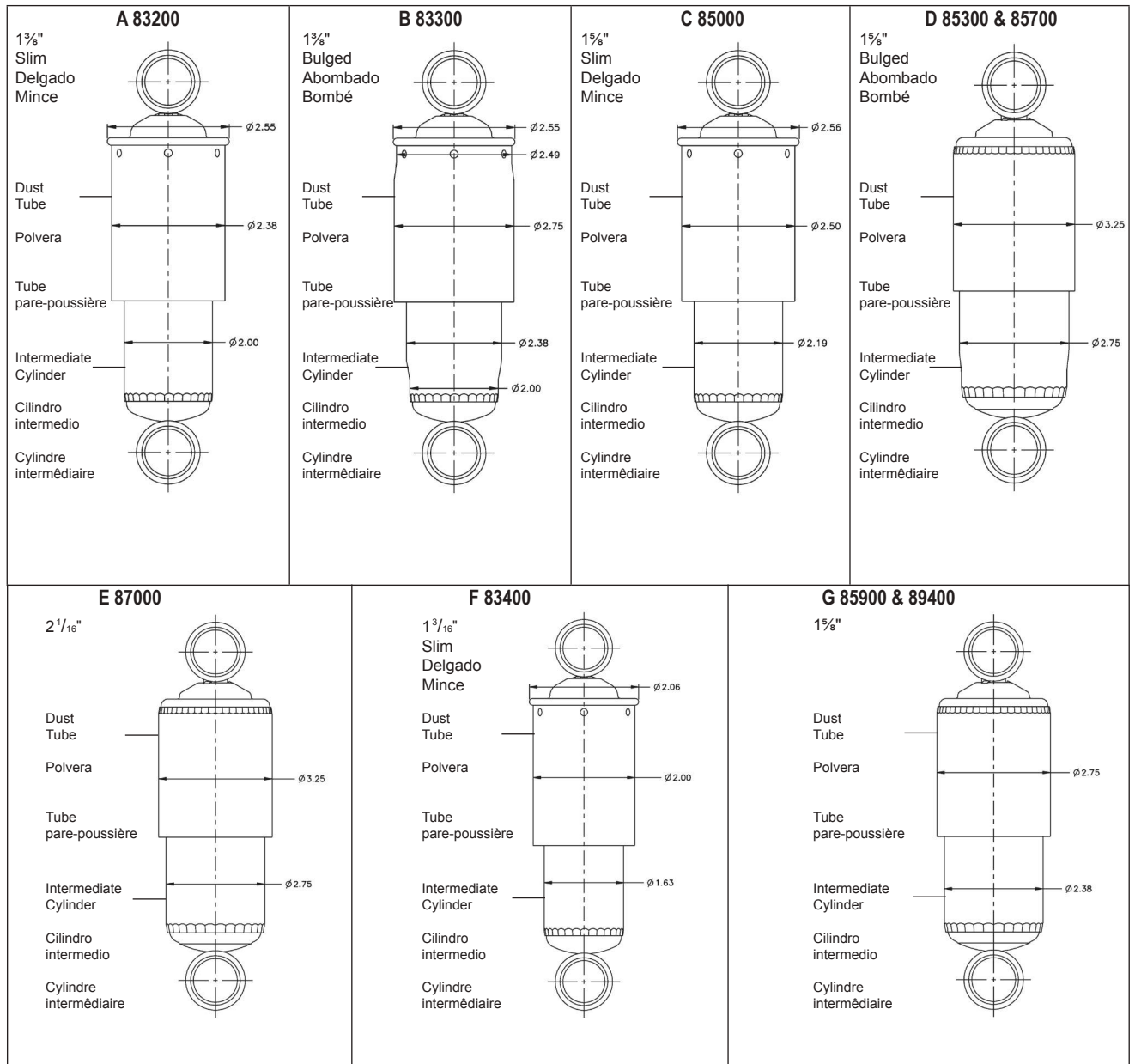

## HOW TO DETERMINE THE CORRECT SHOCK FOR YOUR TRUCK

### CÓMO ESCOGER EL MEJOR AMORTIGUADOR PARA SU CAMIÓN COMMENT CHOISIR LE BON AMORTISSEUR POUR VOTRE CAMION

- STEP 2:** Identify the mounting style. Measure fully extended and fully collapsed lengths at the locations indicated for mounting style.
- 2º PASO:** Identifique el tipo de montaje. Mida la longitud totalmente extendida y totalmente comprimida, en los puntos indicados para cada tipo de montaje.
- 2È ÉTAPE:** Identifiez la méthode de fixation. Mesurez la longueur en pleine extension et en pleine compression, aux endroits indiqués pour la méthode de fixation.

### HOW TO MEASURE EXTENDED & COLLAPSED LENGTHS OF SHOCK ABSORBERS COMO MEDIR LAS LONGITUDES EXTENDIDA Y COMPRIMIDA DE LOS AMORTIGUADORES COMMENT MESURER LES LONGUEURS ALLONGÉ ET COMPRIMÉ DES AMORTISSEURS

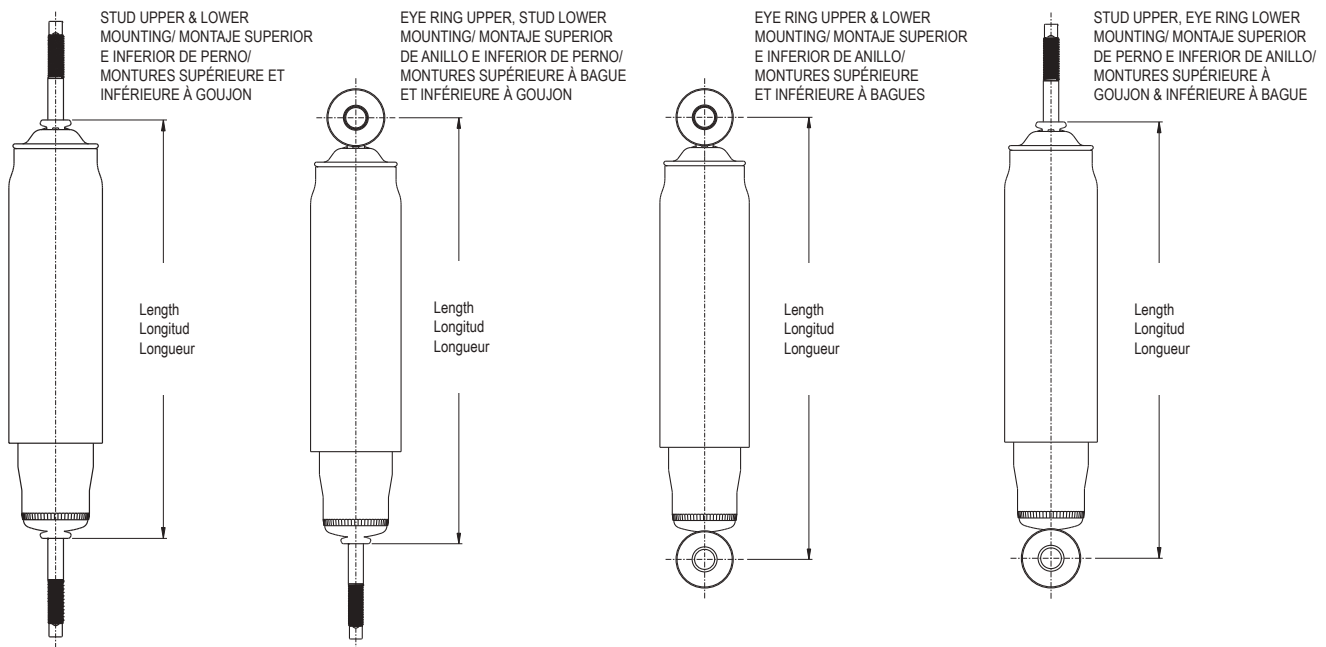

#### INSTRUCTIONS:

1. Using the proper measuring points as shown above find the nearest replacement shock absorber from the listing by increments of extended length.
2. Identify the proper mounting from the mounting codes and match these requirements by carefully measuring the mounting dimensions (top and bottom) of the shock absorber to be replaced.
3. Carefully take note of the following requirements:
  - a. **Dust tubes** - This requirement should be noted in comparison with the shock absorber to be replaced. Shock absorber environment in its application makes this requirement necessary for piston rod protection and extended shock absorber life.
  - b. **Recoil Cutoff and Compression Bumper** - Carefully note these specifications - deviation of length requirements should not exceed  $\pm 1/4$ ". These shock absorber designs are footnoted for easy identification.

**Note:** Shock absorbers used for installations other than those recommended in our catalog are **not subject to warranty**.



# HOW TO DETERMINE THE CORRECT SHOCK FOR YOUR TRUCK

## CÓMO ESCOGER EL MEJOR AMORTIGUADOR PARA SU CAMIÓN

### COMMENT CHOISIR LE BON AMORTISSEUR POUR VOTRE CAMION

#### INSTRUCCIONES:

1. Usando los puntos de medida adecuados como mencionado, encuentre el amortiguador más cercano en la lista por incrementos de la longitud extendida.
  2. Identifique la montaje adecuado por medio de los códigos de fijación y compare estas especificaciones, midiendo cuidadosamente las dimensiones de la montaje (superior e inferior) del amortiguador por reemplazar.
  3. Note cuidadosamente las exigencias siguientes:
    - a. **Polvera** – Este componente debe estar presente en el amortiguador por reemplazar. El ambiente de trabajo del amortiguador hacen a la polvera necesaria para proteger la barra del pisón y extender la vida del producto.
    - b. **Tope de retorno y tope de compresión** - Note cuidadosamente las especificaciones siguientes : las exigencias de longitud no deben de ser excedidas  $\pm 1/4"$ . Estos diseños de amortiguadores están marcados para facilitar su identificación.
- Nota:** Los amortiguadores usados para instalaciones otras que las recomendadas en nuestro catálogo **no son garantizados**.

#### INSTRUCTIONS:

1. En utilisant les points de mesure appropriés comme indiqués ci-dessus, trouvez l'amortisseur de rechange le plus près de cette mesure d'après la longueur allongée.
  2. Repérez les montures appropriées sur les codes des montures et faites correspondre ces exigences en mesurant attentivement les dimensions des montures (haut et bas) de l'amortisseur à replacer.
  3. Avec soin, prenez note des exigences suivantes:
    - a. **Tubes pare-poussière** - Cette exigence devrait être notée en comparaison de l'amortisseur à remplacer. Le milieu de service rend cette exigence nécessaire pour la protection de la tige de piston et une meilleure longévité de l'amortisseur.
    - b. **Arrêt de retour et butée de compression** - Notez avec soin ces spécifications. La déviation par rapport aux exigences de longueurs ne doit pas dépasser  $\pm 1/4$  po. Ces modèles d'amortisseurs portent une note pour une identification facile.
- Note:** Les amortisseurs utilisés pour des installations autres que celles recommandées dans notre catalogue **ne sont pas couverts par la garantie**.

**STEP 3:** Measure end mount diameters, widths, and lengths. Refer to the following end mount tables to determine the appropriate or matching mounting code.

**3ER PASO:** Mida las dimensiones del tubo, así como el diámetro, la anchura y la longitud de las fijaciones. Consulte las tablas siguientes de conteras para determinar el código de montaje apropiado o concorde.

**3E ÉTAPE:** Mesurez le diamètre, la largeur et la longueur des bagues. Consultez les tableaux d'embouts suivants afin d'établir le code de montage approprié ou concordant.

# HOW TO DETERMINE THE CORRECT SHOCK FOR YOUR TRUCK

## CÓMO ESCOGER EL MEJOR AMORTIGUADOR PARA SU CAMIÓN

### COMMENT CHOISIR LE BON AMORTISSEUR POUR VOTRE CAMION

#### MOUNTING CODE "EB" EYE RING AND BUSHING

#### CÓDIGO DE MONTAJE «EB» ANILLO Y BUJE

#### CODE DE MONTURE "EB" A BAGUE ET MANCHON

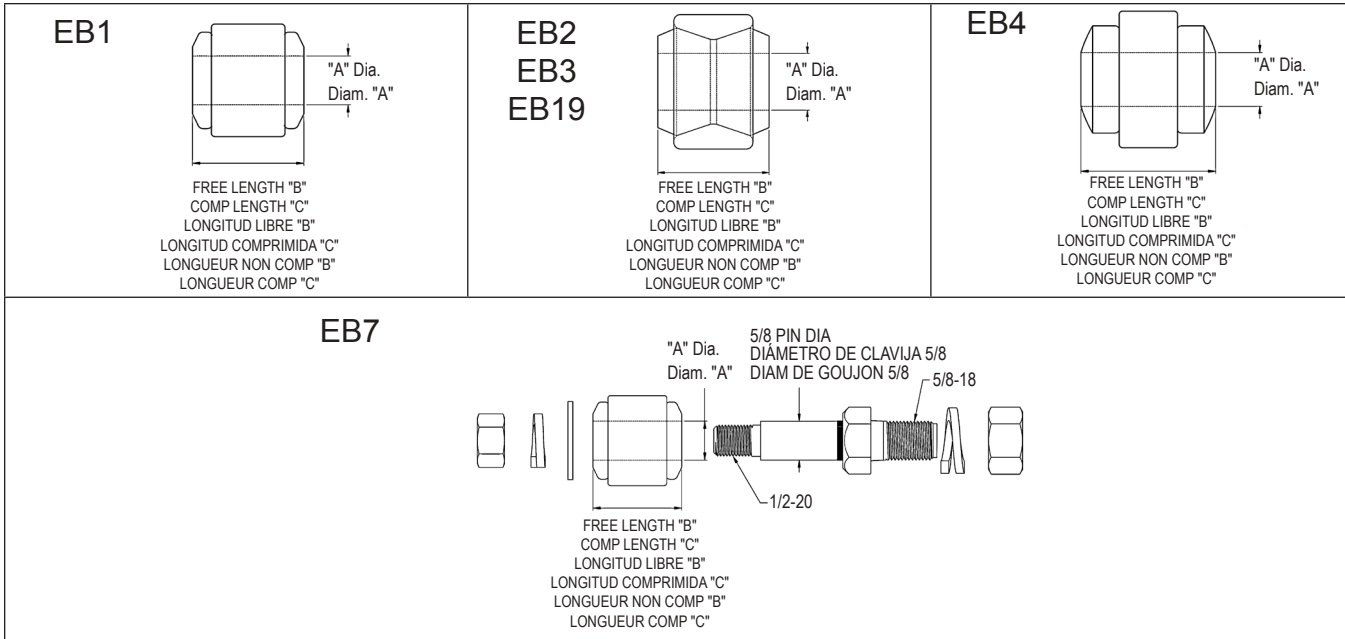

Mounting Code Código de montaje Code de monture	"A" Dia. Diámetro "A" Diam. "A"	B Free Length Longitud libre Long. non comp.	C Comp. Length Longitud comprimida Long. comp.	Vehicle Mounting Pin Dia. Diámetro de clavija de montaje del vehículo Diam. du goujon de montage du véhicule
EB1	5/8	1.44	1.31	5/8
EB2	3/4	1.75	1.50	3/4
EB3	1.00	1.91	1.75	1.00
EB4	11/16	1.72	1.55	11/16
EB7	5/8	1.44	1.31	Mounting pin furnished with shock absorber for 5/8" dia. vehicle mounting hole. Perno proveído con el amortiguador para orificio de montaje de 5/8" de diámetro. Goujon de montage fourni avec l'amortisseur pour trou de montage de 5/8 po de diam. sur véhicule.
EB19	20MM	1.75	--	20MM

# HOW TO DETERMINE THE CORRECT SHOCK FOR YOUR TRUCK

## CÓMO ESCOGER EL MEJOR AMORTIGUADOR PARA SU CAMIÓN COMMENT CHOISIR LE BON AMORTISSEUR POUR VOTRE CAMION

### MOUNTING CODE "ES" EYE RING AND BUSHING WITH STEEL SLEEVE

CÓDIGO DE MONTAJE «ES» ANILLO Y BUJE CON CAMISA DE ACERO

CODE DE MONTURE "ES" BAGUE ET MANCHON AVEC COLLET EN ACIER

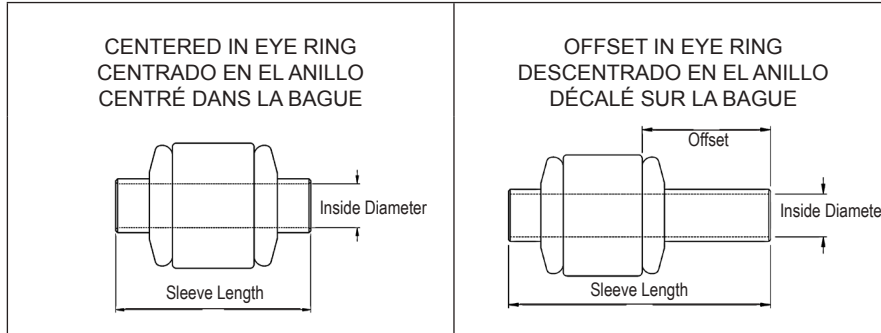

### ES CODES SORTED NUMERICALLY

CÓDIGOS «ES» ORDENADOS NUMÉRICAMENTE

CODES "ES" TRIÉS NUMÉRIQUEMENT

MOUNTING CODE	DIMENSION			
	Inside Diameter		Sleeve Length	
	(inches)	(mm)	(inches)	(mm)
ES18	0.47	12.00	1.65	41.91
ES19	0.47	12.00	1.88	47.75
ES20	0.47	12.00	1.95	49.53
ES24	0.50	12.70	1.38	35.05
ES25	0.50	12.70	1.50	38.10
ES26	0.50	12.70	1.56	39.62
ES27	0.50	12.70	1.62	41.15
ES31*	0.50	12.70	2.25	57.15
ES34	0.56	14.29	1.66	42.16
ES35	0.63	15.88	1.38	35.05
ES36	0.75	19.05	1.75	44.45
ES41	0.47	12.00	3.48	88.39
ES53	0.39	10.00	1.38	35.05
ES56	0.55	14.00	1.58	40.13
ES60	0.55	14.00	1.26	32.00
ES69	0.47	12.00	1.58	40.13
ES83	0.47	12.00	1.48	37.59
ES85	0.47	12.00	2.36	59.94
ES86	0.55	14.00	2.44	61.98
ES90	0.63	15.88	2.00	50.80
ES91	0.50	12.70	2.10	53.34
ES104	0.79	20.00	1.58	40.13
ES106	0.39	10.00	1.48	37.59
ES110	0.63	16.00	1.61	40.89
ES112	0.47	12.00	1.08	27.43
ES113	0.63	16.00	1.49	37.85
ES115	0.39	10.00	2.02	51.31
ES118	0.47	12.00	1.31	33.27
ES120	0.75	19.05	2.76	70.10
ES121	0.75	19.05	2.06	52.32
ES126	0.50	12.70	2.44	61.98
ES128	0.50	12.70	1.66	42.16
ES130	0.50	12.70	1.56	39.62
ES136	0.63	15.88	1.75	44.45
ES138	0.63	15.88	1.70	43.18
ES141	0.47	12.00	1.61	40.89
ES142	0.63	16.00	1.43	36.32
ES147	0.47	12.00	1.97	50.04
ES149	0.50	12.70	2.36	59.94

MOUNTING CODE	DIMENSION			
	Inside Diameter		Sleeve Length	
	(inches)	(mm)	(inches)	(mm)
ES150	0.75	19.05	2.24	56.90
ES152	0.79	20.00	1.69	42.93
ES153	0.55	14.00	1.55	39.37
ES158	0.75	19.05	3.80	96.52
ES159**	0.75	19.05	3.21	81.53
ES160	1.00	25.40	2.01	51.05
ES161	0.63	16.00	3.95	100.33
ES162	0.63	16.00	2.60	66.04
ES163	0.44	11.11	2.50	63.50
ES164	0.50	12.70	2.26	57.40
ES165	0.50	12.70	1.75	44.45
ES166	0.63	15.88	2.97	75.44
ES167	0.55	14.00	2.31	58.67
ES168	0.55	14.00	2.62	66.55
ES169	0.55	14.00	1.91	48.51
ES171	0.50	12.70	1.88	47.75
ES172	0.50	12.70	2.72	69.09
ES173	0.88	22.23	2.28	57.91
ES174	0.63	15.88	3.25	82.55
ES175	0.63	16.00	1.96	49.78
ES176	0.63	16.00	3.72	94.49
ES177	0.63	16.00	3.55	90.17
ES178	0.75	19.05	1.96	49.78
ES179	0.79	20.00	1.75	44.45
ES181	0.44	11.11	1.98	50.29
ES182	0.79	20.00	1.96	49.78
ES183	0.79	20.00	3.80	96.52
ES184	0.79	20.00	2.44	61.98
ES185	0.47	12.00	2.44	61.98
ES187	1.00	25.40	1.75	44.45
ES188	0.63	16.00	1.81	45.97
ES190	0.87	22.00	1.75	44.45
ES193	0.94	24.00	2.28	57.91
ES194	0.88	22.23	2.28	57.91
ES195	0.48	12.30	2.165	54.99
ES206	0.50	12.7	3.13	79.50
ES211	0.47	12.08	3.94	100
ES216	0.57	14.50	3.15	80.00

\* 1.00" Offset

\*\* 1.03" Offset

# HOW TO DETERMINE THE CORRECT SHOCK FOR YOUR TRUCK

## CÓMO ESCOGER EL MEJOR AMORTIGUADOR PARA SU CAMIÓN

## COMMENT CHOISIR LE BON AMORTISSEUR POUR VOTRE CAMION

### MOUNTING CODE "ES" EYE RING AND BUSHING WITH STEEL SLEEVE (Cont'd)

CÓDIGO DE MONTAJE «ES» ANILLO Y BUJE CON CAMISA DE ACERO  
 CODE DE MONTURE "ES" BAGUE ET MANCHON AVEC COLLET EN ACIER

### ES CODES SORTED BY INSIDE DIAMETER / LENGTH

CÓDIGOS «ES» ORDENADOS POR DIÁMETRO INTERIOR / LONGITUD  
 CODES "ES" TRIÉS PAR DIAMÈTRE INTÉRIEUR / LONGUEUR

MOUNTING CODE	DIMENSION			
	Inside Diameter		Length	
	(inches)	(mm)	(inches)	(mm)
ES53	0.39	10.00	1.38	35.05
ES106	0.39	10.00	1.48	37.59
ES115	0.39	10.00	2.02	51.31
ES181	0.44	11.11	1.98	50.29
ES163	0.44	11.11	2.50	63.50
ES112	0.47	12.00	1.08	27.43
ES118	0.47	12.00	1.31	33.27
ES24	0.50	12.70	1.38	35.05
ES83	0.47	12.00	1.48	37.59
ES25	0.50	12.70	1.50	38.10
ES26	0.50	12.70	1.56	39.62
ES130	0.50	12.70	1.56	39.62
ES69	0.47	12.00	1.58	40.13
ES141	0.47	12.00	1.61	40.89
ES27	0.50	12.70	1.62	41.15
ES18	0.47	12.00	1.65	41.91
ES128	0.50	12.70	1.66	42.16
ES165	0.50	12.70	1.75	44.45
ES19	0.47	12.00	1.88	47.75
ES171	0.50	12.70	1.88	47.75
ES20	0.47	12.00	1.95	49.53
ES147	0.47	12.00	1.97	50.04
ES91	0.50	12.70	2.10	53.34
ES195	0.48	12.30	2.165	54.99
ES31*	0.50	12.70	2.25	57.15
ES164	0.50	12.70	2.26	57.40
ES85	0.47	12.00	2.36	59.94
ES149	0.50	12.70	2.36	59.94
ES185	0.47	12.00	2.44	61.98
ES126	0.50	12.70	2.44	61.98
ES172	0.50	12.70	2.72	69.09
ES206	0.50	12.7	3.13	79.50
ES41	0.47	12.00	3.48	88.39
ES211	0.47	12.08	3.94	100
ES60	0.55	14.00	1.26	32.00
ES153	0.55	14.00	1.55	39.37
ES56	0.55	14.00	1.58	40.13
ES34	0.56	14.29	1.66	42.16
ES169	0.55	14.00	1.91	48.51
ES167	0.55	14.00	2.31	58.67
ES86	0.55	14.00	2.44	61.98
ES168	0.55	14.00	2.62	66.55
ES216	0.57	14.50	3.15	80.00

\* 1.00" Offset

MOUNTING CODE	DIMENSION			
	Inside Diameter		Length	
	(inches)	(mm)	(inches)	(mm)
ES35	0.63	15.88	1.38	35.05
ES138	0.63	15.88	1.70	43.18
ES136	0.63	15.88	1.75	44.45
ES90	0.63	15.88	2.00	50.80
ES166	0.63	15.88	2.97	75.44
ES174	0.63	15.88	3.25	82.55
ES142	0.63	16.00	1.43	36.32
ES113	0.63	16.00	1.49	37.85
ES110	0.63	16.00	1.61	40.89
ES188	0.63	16.00	1.81	45.97
ES175	0.63	16.00	1.96	49.78
ES162	0.63	16.00	2.60	66.04
ES177	0.63	16.00	3.55	90.17
ES176	0.63	16.00	3.72	94.49
ES161	0.63	16.00	3.95	100.33
ES36	0.75	19.05	1.75	44.45
ES178	0.75	19.05	1.96	49.78
ES121	0.75	19.05	2.06	52.32
ES150	0.75	19.05	2.24	56.90
ES120	0.75	19.05	2.76	70.10
ES159**	0.75	19.05	3.21	81.53
ES158	0.75	19.05	3.80	96.52
ES104	0.79	20.00	1.58	40.13
ES152	0.79	20.00	1.69	42.93
ES179	0.79	20.00	1.75	44.45
ES182	0.79	20.00	1.96	49.78
ES184	0.79	20.00	2.44	61.98
ES183	0.79	20.00	3.80	96.52
ES190	0.87	22.00	1.75	44.45
ES173	0.88	22.23	2.28	57.91
ES194	0.88	22.23	2.28	57.91
ES193	0.94	24.00	2.28	57.91
ES187	1.00	25.40	1.75	44.45
ES160	1.00	25.40	2.01	51.05

\*\* 1.03" Offset

**MOUNTING CODE "BP" EYE RING AND BUSHING WITH BAR PIN**  
**CÓDIGO DE MONTAJE «BP» ANILLO Y BUJE CON CLAVIJA TIPO BARRA**  
**CODE DE MONTURE "BP" BAGUE ET MANCHON AVEC GOUPILLE**

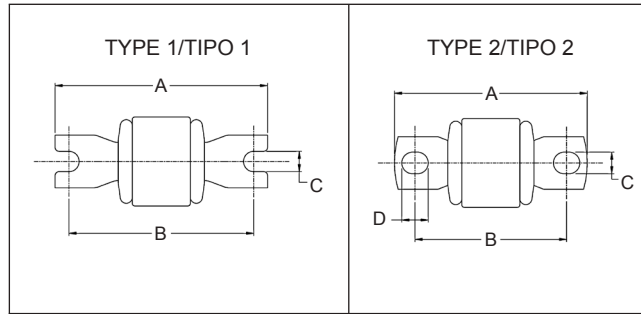

MOUNTING CODE	TYPE	A	B	C	D	E
BP7	2	3.13	2.50	0.35	0.42	--
BP8	2	3.50	2.87	0.35	0.42	--
BP9	1	3.38	2.60	0.35	0.57	--
BP10	2	3.5	2.74	0.50	0.50	--
BP14	2	3.43	2.87	0.45	--	--
BP27	2	4.00	2.95	0.52	0.50	--

# HOW TO DETERMINE THE CORRECT SHOCK FOR YOUR TRUCK

## CÓMO ESCOGER EL MEJOR AMORTIGUADOR PARA SU CAMIÓN

### COMMENT CHOISIR LE BON AMORTISSEUR POUR VOTRE CAMION

#### MOUNTING CODES "S" & "DS" STUD MOUNTS

#### CÓDIGOS DE MONTAJE «S» Y «DS» MONTAJES DE DOBLE PERNO

#### CODES DE MONTURE "S" & "DS" À GOUJON

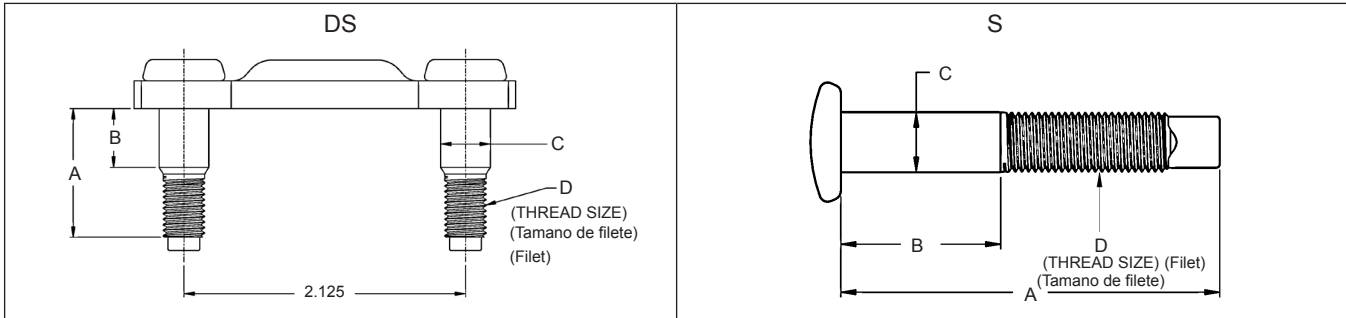

MOUNTING CODE	A	B	C	D
<b>DS1</b>	1.27	0.66	3/8	5/16-24
<b>S1</b>	2.37	1.00	3/8	3/8-24
<b>S10</b>	2.37	1.33	7/16	3/8-24
<b>S11</b>	3.00	1.12	3/8	3/8-24
<b>S12</b>	2.37	1.15	7/16	3/8-24
<b>S16</b>	2.95	1.45	16MM	16MM
<b>S21</b>	3.28	1.75	5/8	5/8-18
<b>S36</b>	2.49	1.33	7/16	3/8-24
<b>S38</b>	2.75	1.70	14MM	12MM
<b>S40</b>	2.52	1.33	7/16	3/8-24
<b>S42</b>	3.50	2.00	5/8	5/8-18
<b>S43</b>	2.75	1.25	5/8	5/8-18
<b>S47</b>	2.20	1.31	10MM	M10x1.25
<b>S61</b>	3.11	1.45	14MM	M12x1.25
<b>S62</b>	3.24	1.70	9/16	M12x1.25
<b>S92</b>	1.42	0.63	0.41	M12x1.25
<b>S104</b>	0.98	0.08	0.47	M12X1.25

**HOW TO DETERMINE THE CORRECT SHOCK FOR YOUR TRUCK**  
**CÓMO ESCOGER EL MEJOR AMORTIGUADOR PARA SU CAMIÓN**  
**COMMENT CHOISIR LE BON AMORTISSEUR POUR VOTRE CAMION**

**SPRING SEAT MOUNTING TYPES**

ASIENTO DE MUELLE  
SIÈGE À RESSORT



**TOP MOUNT - TMT3S**

Triangle Top Mount  
3 Studs



**TOP MOUNT - TMU2B1S**

Unique Top Mount  
2 Bolts, 1 Stud

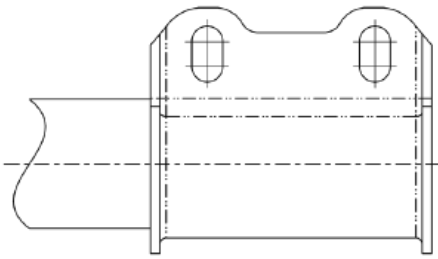

**CLEVIS - CL1**

2 oblong mounting holes

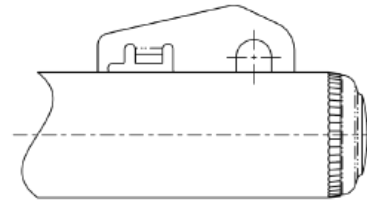

**PINCH SOCKET - LP4**

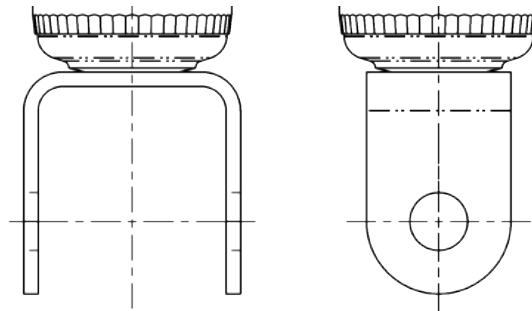

**U JOINT - LU1**

# HOW TO DETERMINE THE CORRECT SHOCK FOR YOUR TRUCK

## CÓMO ESCOGER EL MEJOR AMORTIGUADOR PARA SU CAMIÓN

### COMMENT CHOISIR LE BON AMORTISSEUR POUR VOTRE CAMION

#### EXPLANATION OF COLUMN HEADINGS

#### EXPLICACIÓN DE LOS TÍTULOS DE LAS COLUMNAS

#### EXPLICATION DES EN-TÊTES DE COLONNES

<b>SHOCK ABSORBER PART NUMBER:</b> The catalog number for the individual shock absorber.	<b>Número de parte del amortiguador:</b> El número de catálogo para el amortiguador individual.	<b>Numéro de pièce de l'amortisseur:</b> Le numéro de catalogue pour l'amortisseur individuel.
<b>EXTENDED LENGTH:*</b> The length of the shock absorber when it is fully extended. See "How to Measure" instructions.	<b>Longitud extendida :*</b> La longitud del amortiguador cuando está totalmente extendido. Ver instrucciones «Cómo medir».	<b>Longueur étirée:*</b> La longueur de l'amortisseur entièrement étiré. Voir "Comment mesurer".
<b>COLLAPSED LENGTH:*</b> The length of the shock absorber when it is fully compressed. See "How to Measure" instructions.	<b>Longitud comprimida :*</b> La longitud del amortiguador cuando está totalmente comprimido. Ver instrucciones «Cómo medir».	<b>Longueur comprimée:*</b> La longueur de l'amortisseur entièrement comprimé. Voir "Comment mesurer".
<b>STROKE:</b> This is the approximate length of the stroke of the individual shock absorber being described.	<b>Carrera :</b> Es la longitud aproximada del recorrido del amortiguador descrito.	<b>Course:</b> C'est la longueur approximative de la course de l'amortisseur individuel décrit.
<b>MOUNTING CODES:</b> Indicates the type of mounting ends for the upper and lower end of each shock absorber. They are listed as follows: Stud Type Mounts ("S" & "DS") Eye Ring and Bushing Mounts ("EB") Eye Ring and Bushing with Sleeve Mounts ("ES") Eye Ring and Bushing with Bar Pin Mounts ("BP") Special Mounting Codes ("SP")	<b>Códigos de montaje :</b> Indica el tipo de montantes de montaje superior e inferior para cada amortiguador. Se enlistan como sigue : Montajes tipo perno («S» y «DS») Montajes anillo y buje («EB») Montajes anillo y buje con camisa («ES») Montajes anillo y buje con clavija («BP») Códigos de montajes especiales («SP»)	<b>Codes de montage:</b> Indique le type de montures supérieure et inférieure de chaque amortisseur. Ils sont énumérés comme suit: Montures de type goujon ("S" et "DS") Montures à bague et manchon ("EB") Montures à bague et manchon avec collet ("ES") Montures à bague et manchon avec goupille ("BP") Codes de montures spéciales ("SP")
<b>DUST TUBE:</b> Indicates whether the shock absorber is supplied with a dust tube.	<b>Polvera:</b> Indica si el amortiguador cuenta un polvera.	<b>Tube pare-poussière:</b> Indique que l'amortisseur est fourni avec un tube pare-poussière.
<b>MOUNTING ACCESSORY PACKAGE NUMBER:</b> The part number of the Mount Accessory Package supplied with the shock absorber.	<b>Número de paquete de accesorios de montaje:</b> El número de parte del paquete de accesorios de montaje proveído con el amortiguador.	<b>Numéro d'emballage d'accessoires de montage:</b> Le numéro de pièce de l'emballage d'accessoires de montage fourni avec l'amortisseur.
<b>*NOTE:</b> All dimensions shown are in inches	<b>*Nota :</b> Todas las dimensiones son en pulgadas	<b>*Note:</b> Toutes les dimensions indiquées sont en pouces

**STEP 4:** Refer to shock absorber specifications by end mount. Start first by finding the appropriate series. Next, match the extended/collapsed length and find the correct mounting codes. Refer to the far left column of the chart for the correct Gabriel shock absorber part number.

**4º PASO:** Consulte las especificaciones del amortiguador mostradas al final del catálogo. Encuentre primero la serie adecuada. Luego, compare las longitudes de extensión y de compresión, y encuentre los códigos de montaje correctos. Consulte la columna del extremo izquierdo de la tabla para identificar el número de parte del amortiguador Gabriel correcto.

**4E ÉTAPE:** Reportez-vous aux spécifications d'amortisseur énoncées à la fin du catalogue. Trouvez d'abord la série appropriée. Comparez ensuite les longueurs d'extension et de compression et trouvez les bons codes de fixation. Reportez-vous à la colonne située à la extrême gauche de tableau pour identifier le bon numéro de pièce pour un amortisseur Gabriel.



**SPECIFICATIONS BY END MOUNT**  
**ESPECIFICACIONES POR TIPO DE MONTAJE**  
**SPÉCIFICATIONS PAR FIXATION DES EXTRÉMITÉS**

Gabriel	Mounting		Bore	External Diameter Illustration	Lengths			Dust Tube	Recoil Cutoff	Controls*	
	Upper	Lower			Extended	Collapsed	Stroke			Rebound	Compression
83171		ES36	1-3/8"	A	23.98	14.51	9.47	YES	YES	513	146
83013	BP8	BP8	1-3/16"	2" D/T	7.66	6.63†	1.7	YES	NO	646	480
83015	BP8	S1	1-3/8"	A	9.84	7.59	2.25	YES	YES	735	430
83005	BP8	S10	1-3/16"	2" D/T	7.34	5.87	1.47	YES	NO	858	216
83041	BP27	S10	1-3/8"	A	10.51†	8.34†	3.02	YES	YES	486	189
83060	EB	BP7	1-3/8"	A	9.76	7.98†	2.25	NO	YES	431	441
83401	EB1	EB1	1-3/16"	F	24.09	14.26	9.83	YES	NO	341	252
83007	EB1	EB1	1-3/8"	A	18.55	11.67	6.87	NO	NO	489	343
83011	EB1	EB1	1-3/8"	A	11.55†	8.48	3.61	YES	YES	738	330
83012	EB1	EB1	1-3/8"	A	11.07†	8.21	3.37	YES	YES	738	330
85063	EB2	EB2	1-5/8"	C	32.01	18.85	13.16	YES	NO	762	174
83107	EB2	EB2	1-3/8"	A	31.66	18.4	13.25	YES	NO	352	77
83314	EB2	EB2	1-3/8"	B	30.64	18.11	12.53	YES	YES	633	143
85024	EB2	EB2	1-5/8"	C	28.77	17.25	11.52	YES	YES	1008	539
83309	EB2	EB2	1-3/8"	B	28.64	17.11	11.53	YES	YES	589	135
89416	EB2	EB2	1-5/8"	G	28.62	17.54	11.08	YES	YES	1155‡	514
89401	EB2	EB2	1-5/8"	G	28.41	17.16	11.25	YES	NO	665‡	194
89446	EB2	EB2	1-5/8"	G	28.36	17.41	10.95	YES	YES	702‡	204
85046	EB2	EB2	1-5/8"	C	27.55	16.62	10.93	YES	YES	1008	539
89409	EB2	EB2	1-5/8"	G	27.13	16.92	10.2	YES	YES	567‡	165
89434	EB2	EB2	1-5/8"	G	27.12	16.79	10.33	YES	YES	1155‡	514
89403	EB2	EB2	1-5/8"	G	26.86	17.16	9.7	YES	YES	929‡	281
83312	EB2	EB2	1-3/8"	B	26.64	16.11	10.53	YES	YES	527	152
89439	EB2	EB2	1-5/8"	G	25.67	15.79	9.88	YES	NO	518‡	103
85055	EB2	EB2	1-5/8"	C	25.63	15.63	10	YES	NO	577	102
85047	EB2	EB2	1-5/8"	C	25.31	15.52	9.79	YES	YES	1008	539
83308	EB2	EB2	1-3/8"	B	25.14	15.36	9.78	YES	YES	445	180
89435	EB2	EB2	1-5/8"	G	24.92	15.82	9.1	YES	YES	1155‡	514
83200	EB2	EB2	1-3/8"	A	24.51	15.1	9.53	YES	NO	806	370
89402	EB2	EB2	1-5/8"	G	24.41	15.16	9.25	YES	NO	874‡	206
83519	EB2	EB2	1-3/16"	F	23.83	14.35	9.48	YES	NO	292	132
83216	EB2	EB2	1-3/8"	A	23.51	14.48	9.03	YES	YES	776	262
85054	EB2	EB2	1-5/8"	C	23.26	14.37	8.89	YES	NO	602	104
89438	EB2	EB2	1-5/8"	G	23.17	14.54	8.63	YES	NO	583‡	103
83404	EB2	EB2	1-3/16"	F	22.01	13.44	8.58	YES	NO	545	171
83159	EB2	EB2	1-3/8"	A	21.85	13.56	8.29	YES	NO	658	149
85012	EB2	EB2	1-5/8"	C	21.02	13.23	7.79	YES	NO	523	199
89413	EB2	EB2	1-5/8"	G	20.94	13.53	7.41	YES	NO	536‡	201
85023	EB2	EB2	1-5/8"	C	20.27	13	7.27	YES	YES	1008	539

\* Damping force, in pounds, to either extend or collapse the shock absorber at an average operating velocity. Fuerza de amortiguación en libras para extender o comprimir el amortiguador a una velocidad de operación promedio. La puissance d'amortissement en poids de l'amortisseur, soit comprimé, soit détendu, à une vitesse de fonctionnement moyenne.

† At bumper contact / Al contacto con el tope de goma / Au contact avec le butoir

‡ For GasSLX Series, forces are at the "Firm" (F) setting. / Para la serie GasSLX, las fuerzas están ajustadas en (F) "Firme". / Pour la série GasSLX, le réglage de la force est sur «Firme» (F)

**SPECIFICATIONS BY END MOUNT**  
**ESPECIFICACIONES POR TIPO DE MONTAJE**  
**SPECIFICATIONS PAR FIXATION DES EXTRÉMITÉS**

Gabriel	Mounting		Bore	External Diameter Illustration	Lengths			Dust Tube	Recoil Cutoff	Controls*	
	Upper	Lower			Extended	Collapsed	Stroke			Rebound	Compression
89415	EB2	EB2	1-5/8"	G	20.12	13.29	6.83	YES	YES	1155‡	514
83219	EB2	EB2	1-3/8"	A	20.01	12.73	7.28	YES	YES	299	125
85062	EB2	EB2	1-5/8"	C	19.76	12.6	7.16	YES	NO	523	199
89408	EB2	EB2	1-5/8"	G	19.68	12.9	6.78	YES	NO	536‡	201
85025	EB2	S21	1-5/8"	C	23.02	14.01	9.01	YES	NO	1079	539
85376	EB3	EB3	1-5/8"	D	33.27	19.73	13.54	YES	NO	668	134
85301	EB3	EB3	1-5/8"	D	31.92	19.03	12.89	YES	NO	1442	455
85339	EB3	EB3	1-5/8"	D	31.68	19.02	12.66	YES	YES	804	463
85040	EB3	EB3	1-5/8"	C	30.91	18.51	12.4	YES	NO	889	114
85730	EB3	EB3	1-5/8"	D	30.75	18.72	12.03	YES	YES	1517	293
85315	EB3	EB3	1-5/8"	D	29.61	18.07	11.53	YES	NO	380	142
85901	EB3	EB3	1-5/8"	G	29.09	17.68	11.42	YES	NO	1830	418
85704	EB3	EB3	1-5/8"	D	28.75	18.72	10.03	YES	YES	1435	186
83104	EB3	EB3	1-3/8"	A	28.24	17.12	11.12	YES	NO	698	133
85305	EB3	EB3	1-5/8"	D	27.25	16.7	10.55	YES	NO	1120	225
83362	EB3	EB3	1-3/8"	B	27	16.25	10.75	YES	NO	539	202
87004	EB3	EB3	2-1/16"	E	26.76	16.76	10	YES	YES	1158	190
85735	EB3	EB3	1-5/8"	D	26.72	16.7	10.02	YES	YES	1288	227
83215	EB3	EB3	1-3/8"	A	26.64	16.36	10.28	YES	YES	697	108
89425	EB3	EB3	1-5/8"	G	26.5	16.93	9.57	YES	YES	1352‡	167
85314	EB3	EB3	1-5/8"	D	26.49	16.46	10.03	YES	YES	1216	169
89410	EB3	EB3	1-5/8"	G	26.34	16.57	9.77	YES	NO	1185‡	182
85001	EB3	EB3	1-5/8"	C	26.3	16.39	9.92	YES	NO	1202	186
85313	EB3	EB3	1-5/8"	D	26.26	16.35	9.91	YES	YES	717	111
87003	EB3	EB3	2-1/16"	E	26.26	16.51	9.75	YES	YES	1332	395
89429	EB3	EB3	1-5/8"	G	26.22	16.57	9.65	YES	NO	941‡	266
85320	EB3	EB3	1-5/8"	D	26.15	16.35	9.8	YES	NO	970	308
85700	EB3	EB3	1-5/8"	D	26.09	16.58	9.51	YES	YES	1446	328
83140	EB3	EB3	1-3/8"	A	25.28	15.53	9.75	YES	NO	738	88
83141	EB3	EB3	1-3/8"	A	25.27	15.52	9.75	YES	NO	408	113
83132	EB3	EB3	1-3/8"	A	25.24	15.5	9.74	YES	NO	828	150
85714	EB3	EB3	1-5/8"	D	25.13	15.85	9.28	YES	YES	1220	175
85715	EB3	EB3	1-5/8"	D	25.13	15.85	9.28	YES	YES	1915	200
85717	EB3	EB3	1-5/8"	D	25.13	15.85	9.28	YES	YES	1915	200
89422	EB3	EB3	1-5/8"	G	25.12	16.3	8.83	YES	YES	794‡	253
85308	EB3	EB3	1-5/8"	D	25.11	15.83	9.28	YES	YES	764	254
85303	EB3	EB3	1-5/8"	D	24.76	15.48	9.29	YES	NO	1019	221

\* Damping force, in pounds, to either extend or collapse the shock absorber at an average operating velocity. Fuerza de amortiguación en libras para extender o comprimir el amortiguador a una velocidad de operación promedio. La puissance d'amortissement en poids de l'amortisseur, soit comprimé, doit détendu, à une vitesse de fonctionnement moyenne.

† At bumper contact / Al contacto con el tope de goma / Au contact avec le butoir

‡ For GasSLX Series, forces are at the "Firm" (F) setting. / Para la serie GasSLX, las fuerzas están ajustadas en (F) "Firme". / Pour la série GasSLX, le réglage de la force est sur «Firme» (F)

**SPECIFICATIONS BY END MOUNT**  
**ESPECIFICACIONES POR TIPO DE MONTAJE**  
**SPÉCIFICATIONS PAR FIXATION DES EXTRÉMITÉS**

Gabriel	Mounting		Bore	External Diameter Illustration	Lengths			Dust Tube	Recoil Cutoff	Controls*	
	Upper	Lower			Extended	Collapsed	Stroke			Rebound	Compression
89442	EB3	EB3	1-5/8"	G	24.72	15.74	8.98	YES	NO	1055‡	224
85053	EB3	EB3	1-5/8"	C	24.69	15.52	9.17	YES	NO	1019	227
85329	EB3	EB3	1-5/8"	D	24.52	15.48	9.04	YES	YES	1550	232
85713	EB3	EB3	1-5/8"	D	24.51	15.48	9.04	YES	YES	1157	180
85007	EB3	EB3	1-5/8"	C	24.33	15.4	8.93	YES	YES	1008	171
89412	EB3	EB3	1-5/8"	G	24.26	15.68	8.58	YES	YES	1155‡	169
83225	EB3	EB3	1-3/8"	A	24.14	15.11	9.03	YES	YES	482	159
85307	EB3	EB3	1-5/8"	D	23.98	15.08	8.89	YES	NO	1094	173
85702	EB3	EB3	1-5/8"	D	23.76	15.85	7.91	YES	YES	1093	825
87006	EB3	EB3	2-1/16"	E	23.75	15.25	8.5	YES	YES	1158	272
85736	EB3	EB3	1-5/8"	D	23.61	15.2	8.41	YES	YES	1155	352
87002	EB3	EB3	2-1/16"	E	23.5	15.41	8.09	YES	YES	879	203
89420	EB3	EB3	1-5/8"	G	22.8	14.8	8	YES	NO	862‡	258
83217	EB3	EB3	1-3/8"	A	22.77	14.49	8.28	YES	YES	633	159
85302	EB3	EB3	1-5/8"	D	22.75	14.61	8.14	YES	NO	836	253
85304	EB3	EB3	1-5/8"	D	22.25	14.22	8.03	YES	NO	767	325
85718	EB3	EB3	1-5/8"	D	22.13	15.04	7.09	YES	YES	2506	206
85732	EB3	EB3	2-1/16"	E	22.13	15.11	7.03	YES	YES	2632	382
85716	EB3	EB3	1-5/8"	D	21.99	14.33	7.66	YES	YES	1220	175
87001	EB3	EB3	2-1/16"	E	20.76	13.76	7	YES	YES	1158	190
85734	EB3	EB3	1-5/8"	D	20.73	13.7	7.03	YES	YES	1288	227
85004	EB3	EB3	1-5/8"	C	20.68	13.67	7.01	YES	YES	1019	219
85042	EB3	EB3	1-5/8"	C	20.64	13.61	7.03	YES	YES	333	161
85712	EB3	EB3	1-5/8"	D	20.5	13.47	7.04	YES	YES	1435	562
85720	EB3	EB3	1-5/8"	D	20.5	13.47	7.03	YES	YES	1435	562
85968	EB3	EB3	1-5/8"	G	19.87	13.39	6.48	YES	YES	1069	227
83214	EB3	EB3	1-3/8"	A	19.64	12.86	6.78	YES	YES	269	90
89419	EB3	EB3	1-5/8"	G	18.04	12.67	5.36	YES	YES	1352‡	636
85300	EB3	EB3	1-5/8"	D	17.98	12.21	5.78	YES	YES	1435	676
85719	EB3	EB3	1-5/8"	D	17.25	11.97	5.28	YES	YES	1517	213
85334	EB3	EB3	1-5/8"	D	14.52	10.48	4.04	YES	YES	1271	319
85912	EB3	ES36	1-5/8"	G	18.68	12.57	6.11	YES	YES	1020	219
85327	EB3	ES160	1-5/8"	D	16.01	12.1	3.91	YES	YES	764	162
85322	EB3	ES160	1-5/8"	D	15.26	11.85	3.41	YES	YES	764	162
83353	EB3	S21	1-3/8"	B	24.84	15.06	9.78	YES	NO	432	214
85740	EB3	S21	1-5/8"	D	24.7	15.15	9.55	YES	YES	848	305
85380	EB3	S21	1-5/8"	D	23.95	14.79	9.15	YES	YES	1568	227

\* Damping force, in pounds, to either extend or collapse the shock absorber at an average operating velocity. Fuerza de amortiguación en libras para extender o comprimir el amortiguador a una velocidad de operación promedio. La puissance d'amortissement en poids de l'amortisseur, soit comprimé, doit détendu, à une vitesse de fonctionnement moyenne.

† At bumper contact / Al contacto con el tope de goma / Au contact avec le butoir

‡ For GasSLX Series, forces are at the "Firm" (F) setting. / Para la serie GasSLX, las fuerzas están ajustadas en (F) "Firme". / Pour la série GasSLX, le réglage de la force est sur «Firme» (F)

**SPECIFICATIONS BY END MOUNT**  
**ESPECIFICACIONES POR TIPO DE MONTAJE**  
**SPECIFICATIONS PAR FIXATION DES EXTRÉMITÉS**

Gabriel	Mounting		Bore	External Diameter Illustration	Lengths			Dust Tube	Recoil Cutoff	Controls*	
	Upper	Lower			Extended	Collapsed	Stroke			Rebound	Compression
85312	EB3	S21	1-5/8"	D	23.68	14.8	8.88	YES	YES	717	111
85733	EB3	S21	1-5/8"	D	23.57	14.73	8.84	YES	YES	717	111
85379	EB3	S21	1-5/8"	D	22.69	14.4	8.29	YES	YES	1658	176
85330	EB3	S21	1-5/8"	D	22.44	14.16	8.28	YES	YES	1140	176
85729	EB3	S21	1-5/8"	D	21.55	13.77	7.78	YES	YES	783	111
85723	EB3	S21	1-5/8"	D	19.93	12.9	7.03	YES	YES	1318	248
83117	EB4	EB1	1-3/8"	A	23.98	14.47	9.51	YES	NO	354	300
83119	EB4	ES165	1-3/8"	A	23.96	14.84	9.12	YES	NO	354	300
83303	EB7	ES36	1-3/8"	B	24.86	15.08	9.78	YES	YES	470	122
83304	EB7	ES36	1-3/8"	B	22.86	14.08	8.78	YES	YES	470	122
619501	ES1	ES1	1"		32.65†	19.69	13.22	NO	NO	55	27
83002	ES10	ES10	1-3/8"	A	11.65	8.66	3	YES	YES	3112	590
83024	ES10	ES10	1-3/8"	2-1/2" D/T	11.65	8.66	3	YES	YES	811	320
83031	ES10	ES10	1-3/8"	2-1/2" D/T	11.54	8.66	2.88	YES	YES	811	314
83016	ES10	ES10	1"	1-5/8"	11.51	8.14	3.37	NO	YES	506	139
83021	ES10	ES10	1-3/8"	A	9.41	7.4	2.01	YES	YES	745	315
83051	ES10	ES10	1-3/8"	2-1/2" D/T	9.41	7.4	2.01	YES	YES	579	163
83061	ES10	ES10	1-3/8"	2-1/2" D/T	9.41	7.4	2.01	YES	YES	1030	220
83046	ES10	ES181	1-3/16"		9.23†	7.62†	2.73	NO	YES	514	173
83023	ES10	ES181	1"	1-5/8"	8.7	7.09†	2.14	NO	YES	484	157
83045	ES19	S10	1-3/8"	A	11.53†	8.58†	3.81	YES	NO	510	153
83050	ES19	S10	1-3/8"	A	10.43†	8.38†	2.9	YES	YES	599	321
83058	ES19	S10	1-3/8"	A	10.43†	8.38†	2.9	YES	YES	742	243
83909	ES20	ES211	1-3/8"	A	9.45	7.33	2.12	YES	YES	646	180
83158	ES22	ES22	1-3/8"	A	12.96	8.97	4	YES	NO	783	484
83022	ES24	ES24	1"	2" D/T	14.28	9.33	4.95	YES	NO	840	152
83010	ES24	ES24	1"	2" D/T	14.15†	9.33	5.07	YES	YES	188	70
83026	ES24	ES24	1-3/8"	A	13.11	9.12	3.99	YES	YES	602	104
83027	ES24	S10	1-3/8"	A	13.82	9.2	4.61	YES	YES	602	104
83018	ES24	S10	1-3/8"	A	10.3†	8.42†	3.24	YES	YES	515	174
83019	ES24	S10	1-3/8"	A	9.48	8.21†	2.29	YES	YES	509	121
83908	ES27	ES91	1-3/8"	A	9.3	7.03	2.27	YES	NO	904	279
83044	ES27	ES164	1-3/8"	A	10.91	7.93	2.98	YES	YES	789	296
83153	ES34	ES34	1-3/8"	A	21.69	13.62	8.07	YES	YES	974	206
83155	ES34	ES34	1-3/8"	A	21.69	13.62	8.07	YES	YES	507	80
83059	ES35	ES35	1-3/8"	A	12.06†	8.68	3.88	YES	YES	738	350
83004	ES35	ES136	1"	2" D/T	9.36†	7.29	2.32	YES	YES	539	324
85905	ES36	EB3	1-5/8"	G	23.81	16.16	7.66	YES	YES	1020	219

\* Damping force, in pounds, to either extend or collapse the shock absorber at an average operating velocity. Fuerza de amortiguación en libras para extender o comprimir el amortiguador a una velocidad de operación promedio. La puissance d'amortissement en poids de l'amortisseur, soit comprimé, doit détendu, à une vitesse de fonctionnement moyenne.

† At bumper contact / Al contacto con el tope de goma / Au contact avec le butoir

‡ For GasSLX Series, forces are at the "Firm" (F) setting. / Para la serie GasSLX, las fuerzas están ajustadas en (F) "Firme". / Pour la série GasSLX, le réglage de la force est sur «Firme» (F)

**SPECIFICATIONS BY END MOUNT**  
**ESPECIFICACIONES POR TIPO DE MONTAJE**  
**SPÉCIFICATIONS PAR FIXATION DES EXTRÉMITÉS**

Gabriel	Mounting		Bore	External Diameter Illustration	Lengths			Dust Tube	Recoil Cutoff	Controls*	
	Upper	Lower			Extended	Collapsed	Stroke			Rebound	Compression
85913	ES36	EB3	1-5/8"	G	22.56	15.2	7.36	YES	YES	1020	219
85057	ES36	EB3	1-5/8"	C	21.45	14.23	7.22	YES	YES	1216	115
85907	ES36	EB3	1-5/8"	G	21.43	14.2	7.23	YES	YES	1216	251
83113	ES36	EB3	1-3/8"	A	20.47	13.46	7.01	YES	YES	997	238
85059	ES36	EB3	1-5/8"	C	19.09	12.8	6.29	YES	YES	928	151
85915	ES36	EB3	1-5/8"	G	19.06	12.7	6.36	YES	YES	1020	219
83115	ES36	EB3	1-3/8"	A	16.19	13.32	4.87	YES	YES	997	238
83242	ES36	ES36	1-3/8"	A	33.73	20.98	12.75	YES	YES	721	135
85903	ES36	ES36	1-5/8"	G	31.99	19.13	12.86	YES	YES	666	113
85979	ES36	ES36	1-5/8"	G	31.18	18.66	12.52	YES	YES	582	138
85972	ES36	ES36	1-5/8"	G	30.78	18.26	12.52	YES	NO	1493	261
83121	ES36	ES36	1-3/8"	A	30.25	18.32	11.93	YES	YES	689	126
83137	ES36	ES36	1-3/8"	A	30.04	17.79	12.25	YES	YES	517	132
85976	ES36	ES36	1-5/8"	G	29.92	18.12	11.8	YES	YES	582	138
85013	ES36	ES36	1-5/8"	C	29.79	17.76	12.04	YES	YES	1019	219
83205	ES36	ES36	1-3/8"	A	29.69	17.69	12	YES	YES	660	76
89414	ES36	ES36	1-5/8"	G	29.65	18.18	11.46	YES	YES	1045‡	217
83209	ES36	ES36	1-3/8"	A	29.64	17.61	12.03	YES	YES	670	78
85337	ES36	ES36	1-5/8"	D	28.72	17.44	11.28	YES	YES	1318	374
85006	ES36	ES36	1-5/8"	C	28.54	17.13	11.41	YES	YES	1019	219
83125	ES36	ES36	1-3/8"	A	28.15	17.16	10.99	YES	YES	625	115
85097	ES36	ES36	1-5/8"	C	27.95	17.11	10.84	YES	YES	1086	109
85043	ES36	ES36	1-5/8"	C	27.63	16.85	10.78	YES	YES	628	163
85904	ES36	ES36	1-5/8"	G	27.61	16.88	10.73	YES	YES	666	113
85010	ES36	ES36	1-5/8"	C	26.8	16.26	10.54	YES	YES	1019	219
83123	ES36	ES36	1-3/8"	A	26.65	16.41	10.24	YES	YES	589	119
83176	ES36	ES36	1-3/8"	A	26.62	15.96	10.66	NO	NO	406	275
85036	ES36	ES36	1-5/8"	C	26.38	16.29	10.09	YES	YES	633	119
89405	ES36	ES36	1-5/8"	G	26.3	16.57	9.73	YES	YES	1009‡	249
85099	ES36	ES36	1-5/8"	C	26.02	15.93	10.09	YES	YES	1152	135
85974	ES36	ES36	1-5/8"	G	26.02	16.11	9.91	YES	YES	3087	230
85321	ES36	ES36	1-5/8"	D	25.38	15.59	9.79	YES	YES	1435	676
83122	ES36	ES36	1-3/8"	A	25.28	15.79	9.49	YES	YES	661	201
83149	ES36	ES36	1-3/8"	A	25.28	15.78	9.49	YES	YES	332	101
83218	ES36	ES36	1-3/8"	A	25.19	15.44	9.75	YES	YES	721	194
665472	ES36	ES36	1-5/8"	G	25.14	15.61	9.53	NO	NO	925	977
85005	ES36	ES36	1-5/8"	C	24.76	15.24	9.52	YES	YES	1019	219

\* Damping force, in pounds, to either extend or collapse the shock absorber at an average operating velocity. Fuerza de amortiguación en libras para extender o comprimir el amortiguador a una velocidad de operación promedio. La puissance d'amortissement en poids de l'amortisseur, soit comprimé, doit détendu, à une vitesse de fonctionnement moyenne.

† At bumper contact / Al contacto con el tope de goma / Au contact avec le butoir

‡ For GasSLX Series, forces are at the "Firm" (F) setting. / Para la serie GasSLX, las fuerzas estan ajustada en (F) "Firme". / Pour la série GasSLX, le réglage de la force est sur «Firme» (F)

**SPECIFICATIONS BY END MOUNT**  
**ESPECIFICACIONES POR TIPO DE MONTAJE**  
**SPECIFICATIONS PAR FIXATION DES EXTRÉMITÉS**

Gabriel	Mounting		Bore	External Diameter Illustration	Lengths			Dust Tube	Recoil Cutoff	Controls*	
	Upper	Lower			Extended	Collapsed	Stroke			Rebound	Compression
89406	ES36	ES36	1-5/8"	G	24.76	15.82	8.93	YES	YES	658‡	125
85916	ES36	ES36	1-5/8"	G	24.65	15.55	9.1	YES	YES	1149	219
89430	ES36	ES36	1-5/8"	G	24.61	15.66	8.94	YES	YES	1462‡	279
83126	ES36	ES36	1-3/8"	A	24.41	15.27	9.14	YES	YES	625	115
85909	ES36	ES36	1-5/8"	G	24.25	15.19	9.06	YES	YES	700	255
85975	ES36	ES36	1-5/8"	G	24.24	15.15	9.09	YES	YES	1658	219
83310	ES36	ES36	1-3/8"	B	24.06	14.69	9.37	YES	NO	559	153
85030	ES36	ES36	1-5/8"	C	24.05	14.89	9.16	YES	YES	1019	219
83221	ES36	ES36	1-3/8"	A	24.01	14.73	9.28	YES	YES	599	153
89440	ES36	ES36	1-5/8"	G	23.9	15.31	8.59	YES	YES	1498‡	561
83144	ES36	ES36	1-3/8"	A	23.78	15.03	8.74	YES	YES	596	93
89432	ES36	ES36	1-5/8"	G	23.42	14.79	8.63	YES	NO	1507‡	561
85050	ES36	ES36	1-5/8"	C	23.28	14.5	9.03	YES	NO	525	138
665937	ES36	ES36	1-5/8"	G	22.91	16.09	6.82	YES	NO		
85058	ES36	ES36	1-5/8"	C	22.67	14.26	8.41	YES	YES	722	114
85044	ES36	ES36	1-5/8"	C	22.63	14.1	8.53	YES	NO	722	212
85971	ES36	ES36	1-5/8"	G	22.56	14.17	8.39	YES	NO	2315	451
85919	ES36	ES36	1-5/8"	G	22.52	14.33	8.19	YES	YES	1265	121
646155	ES36	ES36	1-3/16"		22.45	14.1	8.35	YES	NO		
646177	ES36	ES36	1-3/16"		22.45	14.1	8.35	NO	NO		
89431	ES36	ES36	1-5/8"	G	22.41	14.16	8.25	YES	NO	751‡	211
85345	ES36	ES36	1-5/8"	D	21.83	13.82	8.01	YES	YES	1093	219
85906	ES36	ES36	1-5/8"	G	21.77	14.05	7.72	YES	YES	700	255
85014	ES36	ES36	1-5/8"	C	21.76	13.74	8.02	YES	YES	1019	219
83124	ES36	ES36	1-3/8"	A	21.65	13.77	7.88	YES	YES	750	137
83207	ES36	ES36	1-3/8"	A	21.64	13.61	8.03	YES	YES	553	143
89407	ES36	ES36	1-5/8"	G	21.61	14.17	7.45	YES	YES	652‡	218
85091	ES36	ES36	1-5/8"	C	21.38	13.56	7.82	YES	NO	1121	331
85910	ES36	ES36	1-5/8"	G	20.79	13.54	7.25	YES	YES	1074	219
85029	ES36	ES36	1-5/8"	C	20.54	13.11	7.43	YES	YES	1019	219
85382	ES36	ES36	1-5/8"	D	20.22	13.07	7.15	YES	YES	1658	420
83127	ES36	ES36	1-3/8"	A	20.16	13.14	7.01	YES	YES	940	218
83204	ES36	ES36	1-3/8"	A	20.14	12.86	7.28	YES	YES	451	110
89437	ES36	ES36	1-5/8"	G	20.12	13.42	6.7	YES	YES	1155‡	514
85060	ES36	ES36	1-5/8"	C	19.79	12.76	7.04	YES	YES	943	405
85338	ES36	ES36	1-5/8"	D	19.47	12.68	6.79	YES	YES	1664	420
85051	ES36	ES36	1-5/8"	C	18.54	12.13	6.41	YES	YES	1019	139

\* Damping force, in pounds, to either extend or collapse the shock absorber at an average operating velocity. Fuerza de amortiguación en libras para extender o comprimir el amortiguador a una velocidad de operación promedio. La puissance d'amortissement en poids de l'amortisseur, soit comprimé, doit détendu, à une vitesse de fonctionnement moyenne.

† At bumper contact / Al contacto con el tope de goma / Au contact avec le butoir

‡ For GasSLX Series, forces are at the "Firm" (F) setting. / Para la serie GasSLX, las fuerzas están ajustadas en (F) "Firme". / Pour la série GasSLX, le réglage de la force est sur «Firme» (F)

**SPECIFICATIONS BY END MOUNT**  
**ESPECIFICACIONES POR TIPO DE MONTAJE**  
**SPÉCIFICATIONS PAR FIXATION DES EXTRÉMITÉS**

Gabriel	Mounting		Bore	External Diameter Illustration	Lengths			Dust Tube	Recoil Cutoff	Controls*	
	Upper	Lower			Extended	Collapsed	Stroke			Rebound	Compression
85908	ES36	ES36	1-5/8"	G	18.48	12.25	6.23	YES	YES	1020	219
83130	ES36	ES36	1-3/8"	A	18.03	12.04	5.99	YES	YES	871	177
85934	ES36	ES36	1-5/8"	G	17.8	12.04	5.75	YES	YES	3511	1063
85086	ES36	ES36	1-5/8"	C	17.55	11.63	5.92	YES	YES	2027	389
85738	ES36	ES36	1-5/8"	D	17.46	11.69	5.77	YES	YES	1830	416
85323	ES36	ES36	1-5/8"	D	17.36	11.58	5.78	YES	YES	1085	163
87018	ES36	ES36	2-1/16"	E	17.36	11.71	5.65	YES	YES	2479	1000
83389	ES36	ES36	1-3/8"	A	17.32	11.57	5.75	YES	YES	1084	228
85000	ES36	ES36	1-5/8"	C	17.28	11.5	5.78	YES	YES	1019	219
89436	ES36	ES36	1-5/8"	G	17.24	12.04	5.2	YES	YES	998†	217
83203	ES36	ES36	1-3/8"	A	17.1	11.36	5.74	YES	YES	609	114
83128	ES36	ES36	1-3/8"	A	16.89	11.53	5.36	YES	YES	940	218
85911	ES36	ES36	1-5/8"	G	16.89	11.53	5.36	YES	YES	1020	219
83363	ES36	ES36	1-3/8"	A	16.46	11.35	5.11	YES	YES	1084	201
85938	ES36	ES36	1-5/8"	G	16.06	10.82	5.24	YES	YES	1581	432
85064	ES36	ES36	1-5/8"	C	16.02	10.75	5.27	YES	YES	1481	340
83150	ES36	ES36	1-3/8"	A	15.24	10.43	4.81	YES	YES	940	216
85078	ES36	ES36	1-5/8"	C	14.76	10.12	4.64	YES	YES	1409	282
85045	ES36	ES36	1-5/8"	C	14.52	10.12	4.4	YES	YES	1020	219
85939	ES36	ES36	1-5/8"	G	14.44	10.04	4.41	YES	YES	1719	420
85914	ES36	ES36	1-5/8"	G	14.36	10.25	4.11	YES	YES	1020	219
85052	ES36	ES36	1-5/8"	C	13.26	9.49	3.77	YES	YES	1429	335
85344	ES36	ES36	1-5/8"	D	13.22	9.45	3.77	YES	YES	1581	443
85079	ES36	ES36	1-5/8"	C	12.04	8.87	3.17	YES	YES	1494	325
83157	ES36	ES90	1-3/8"	A	26.38	15.76	10.61	YES	NO	446	303
85102	ES36	ES136	1-5/8"	C	21.52	14.93	6.59	YES	YES	1224	342
83164	ES36	ES165	1-3/8"	C	24.22	14.59	9.63	YES	NO	426	274
85072	ES36	ES176	1-5/8"	C	24.17	14.81	9.36	YES	YES	1387	305
85087	ES36	ES176	1-5/8"	C	22.78	14.7	8.08	YES	YES	1568	403
85109	ES36	ES195	1-5/8"	C	24.21	15.14	9.07	YES	YES	1123	149
83635	ES36	S21	1-3/8"	A	21.74	13.25	8.49	YES	NO	558	119
85977	ES36	S42	1-5/8"	G	26.2	15.91	10.29	YES	YES	582	138
83109	ES36	S42	1-3/8"	A	26.17	15.93	10.24	YES	YES	345	78
83111	ES36	S42	1-3/8"	A	26.17	15.93	10.24	YES	YES	560	141
83138	ES36	S42	1-3/8"	A	23.55	14.42	9.12	YES	YES	997	231
83110	ES36	S42	1-3/8"	A	22.94	14.31	8.63	YES	YES	450	143
83112	ES36	S42	1-3/8"	A	21.52	13.41	8.11	YES	YES	1064	343
83033	ES53	ES53	1-3/8"	A	13.99	10.37	3.62	YES	YES	494	312

\* Damping force, in pounds, to either extend or collapse the shock absorber at an average operating velocity. Fuerza de amortiguación en libras para extender o comprimir el amortiguador a una velocidad de operación promedio. La puissance d'amortissement en poids de l'amortisseur, soit comprimé, doit détendu, à une vitesse de fonctionnement moyenne.

† At bumper contact / Al contacto con el tope de goma / Au contact avec le butoir

‡ For GasSLX Series, forces are at the "Firm" (F) setting. / Para la serie GasSLX, las fuerzas están ajustadas en (F) "Firme". / Pour la série GasSLX, le réglage de la force est sur «Firme» (F)



**SPECIFICATIONS BY END MOUNT**  
**ESPECIFICACIONES POR TIPO DE MONTAJE**  
**SPECIFICATIONS PAR FIXATION DES EXTRÉMITÉS**

Gabriel	Mounting		Bore	External Diameter Illustration	Lengths			Dust Tube	Recoil Cutoff	Controls*	
	Upper	Lower			Extended	Collapsed	Stroke			Rebound	Compression
83131	ES83	ES83	1-3/8"	A	27.8	18.18	9.62	YES	NO	212	129
83145	ES83	ES83	1-3/8"	A	19.93	12.32	7.54	YES	NO	479	153
83911	ES85	EB1	1-3/8"	A	10.45†	8.41†	2.99	YES	YES	991	321
83906	ES85	EB1	1-3/8"	2-1/2" D/T	10.45†	8.41†	3.01	YES	YES	586	320
83048	ES86	ES167	1-3/8"	A	9.97	8.43†	2.37	YES	YES	904	415
83028	ES86	ES167	1-3/8"	A	9.96	7.6	2.33	YES	YES	445	531
83905	ES86	ES167	1-3/8"	2-1/2" D/T	9.3†	7.81†	2.21	YES	YES	1105	170
85639	ES90	ES36	1-5/8"	G	27.08	17.79	9.29	YES	NO	795	109
85963	ES90	ES36	1-5/8"	G	25.49	18.68	6.81	YES	YES	1490	206
85964	ES90	ES36	1-5/8"	G	25.49	18.68	6.81	YES	YES	1981	205
85995	ES90	ES36	1-5/8"	G	23.5	14.52	8.98	YES	NO	1830	173
85994	ES90	ES36	1-5/8"	G	21.21	13.4	7.81	YES	NO	1824	263
85637	ES90	ES36	1-5/8"	G	20.74	13.19	7.55	YES	NO	2256	327
85954	ES90	ES36	1-5/8"	G	20.43	13	7.43	YES	NO	1812	148
85924	ES90	ES36	1-5/8"	G	20.39	12.99	7.41	YES	NO	1036	122
89457	ES90	ES36	1-5/8"	G	19.92	13.02	6.89	YES	NO	941‡	156
85969	ES90	ES36	1-5/8"	G	18.38	11.93	6.45	YES	NO	1612	125
83180	ES90	ES83	1-3/8"		30.2	21.24	8.96	YES	NO	909	204
83364	ES90	ES83	1-3/8"	A	24.06	15.07	8.99	YES	YES	855	206
83146	ES90	ES83	1-3/8"	A	24.02	14.68	9.33	YES	YES	479	119
85082	ES90	ES90	1-5/8"	C	28.6	20.64	7.97	YES	YES	1435	266
83636	ES90	ES90	1-3/8"	A	27.72	16.95	10.77	YES	YES	505	148
83100	ES90	ES90	1-3/8"	A	26.6	16.11	10.49	YES	YES	481	142
85926	ES90	ES90	1-5/8"	G	26.5	17.96	8.54	YES	YES	1387	279
85656	ES90	ES90	1-5/8"	G	26.49	16.94	9.55	YES	YES	1225	274
85953	ES90	ES90	1-5/8"	G	26.13	15.86	10.27	YES	NO	2001	153
85003	ES90	ES90	1-5/8"	C	25.42	15.63	9.79	YES	YES	437	182
89411	ES90	ES90	1-5/8"	G	25.39	16.06	9.34	YES	YES	436‡	186
85927	ES90	ES90	1-5/8"	G	24.76	15.47	9.3	YES	YES	1288	388
83101	ES90	ES90	1-3/8"	A	24.63	15.13	9.49	YES	YES	481	142
85998	ES90	ES90	1-5/8"	G	22.83	14.17	8.66	YES	NO	1345	178
85925	ES90	ES90	1-5/8"	G	22.56	15.6	6.95	YES	NO	761	144
85648	ES90	ES90	1-5/8"	G	22.28	13.97	8.31	YES	NO	761	247
85957	ES90	ES90	1-5/8"	G	20.78	13.19	7.6	YES	NO	1583	138
85928	ES90	ES90	1-5/8"	G	20.31	13.24	7.07	YES	NO	957	229
85929	ES90	ES90	1-5/8"	G	20.28	13.21	7.08	YES	NO	2214	267
85999	ES90	ES90	1-5/8"	G	19.84	12.79	7.05	YES	NO	2214	259

\* Damping force, in pounds, to either extend or collapse the shock absorber at an average operating velocity. Fuerza de amortiguación en libras para extender o comprimir el amortiguador a una velocidad de operación promedio. La puissance d'amortissement en poids de l'amortisseur, soit comprimé, doit détendu, à une vitesse de fonctionnement moyenne.

† At bumper contact / Al contacto con el tope de goma / Au contact avec le butoir

‡ For GasSLX Series, forces are at the "Firm" (F) setting. / Para la serie GasSLX, las fuerzas están ajustadas en (F) "Firme". / Pour la série GasSLX, le réglage de la force est sur «Firme» (F)



**SPECIFICATIONS BY END MOUNT**  
**ESPECIFICACIONES POR TIPO DE MONTAJE**  
**SPÉCIFICATIONS PAR FIXATION DES EXTRÉMITÉS**

Gabriel	Mounting		Bore	External Diameter Illustration	Lengths			Dust Tube	Recoil Cutoff	Controls*	
	Upper	Lower			Extended	Collapsed	Stroke			Rebound	Compression
83135	ES90	ES90	1-3/8"	A	19.49	12.38	7.11	YES	NO	519	121
83167	ES90	ES90	1-3/8"	A	19.49	12.38	7.11	YES	NO	285	90
83156	ES90	ES90	1-3/8"	A	18.55	11.91	6.64	YES	NO	778	135
83169	ES90	ES90	1-3/8"	A	18.55	11.91	6.64	YES	NO	599	171
83020	ES91	ES91	1-3/8"	A	9.41	7.17	2.24	YES	YES	796	255
83034	ES115	ES115	1-3/16"	1-5/8"	10.04†	7.32	2.97	NO	YES	430	129
83634	ES120	ES120	1-3/8"	A	27.48	16.23	11.25	YES	YES	779	157
85011	ES120	ES121	1-5/8"	C	27.49	16.46	11.03	YES	NO	1268	186
85122	ES120	S21	1-5/8"	C	22.22	13.78	8.44	YES	YES	926	162
83120	ES120	S21	1-3/8"	A	22.17	13.66	8.51	YES	YES	779	164
85123	ES120	S21	1-5/8"	C	21.49	13.26	8.23	YES	NO	1809	246
83154	ES120	S21	1-3/8"	A	20.78	12.72	8.06	YES	YES	599	140
83081	ES126	ES172	1-3/8"	A	13.39	9.98†	4	YES	YES	1004	232
83160	ES128	ES36	1-3/8"	A	24.31	14.9	9.37	YES	YES	920	161
83174	ES128	ES36	1-3/8"	A	24.31	14.9	9.37	YES	YES	795	160
85650	ES136	ES34	1-5/8"	G	24.88	16.35	8.53	YES	NO	941	463
83008	ES136	ES136	1-3/8"	A	13†	10.13†	4	YES	YES	699	307
83056	ES136	ES136	1-5/8"	C	11.53	8.63	2.89	YES	YES	3830	737
83042	ES136	ES136	1-3/8"	A	9.89†	8.52†	2.39	YES	YES	954	541
83030	ES136	ES136	1-3/8"	A	9.61†	7.61	2.5	YES	YES	308	87
85026	ES136	S21	1-5/8"	C	23.02	14.01	9.01	YES	NO	1079	539
89417	ES136	S21	1-5/8"	G	22.94	14.31	8.63	YES	NO	1226‡	515
83907	ES147	ES147	1-3/8"	A	14.97	10.61	4.36	YES	YES	460	365
83047	ES149	EB1	1-3/8"	A	11.78†	9.74†	3	YES	YES	364	314
83006	ES149	EB1	1-3/8"	A	10.71	8.52†	2.78	YES	YES	525	182
83001	ES149	EB1	1-3/8"	A	10.45†	8.41†	3	YES	YES	793	363
83038	ES149	EB1	1-3/8"	A	10.45†	8.41†	3	YES	YES	336	242
83017	ES149	ES149	1-3/8"	A	10.95	8.41†	3.13	YES	YES	353	138
83009	ES149	ES149	1-3/8"	A	10.45†	8.41†	3	YES	YES	793	363
83039	ES149	ES149	1-3/8"	A	10.44†	8.4†	3	YES	YES	876	326
83064	ES149	ES149	1-3/8"	A	10.41†	8.36†	2.99	YES	YES	635	323
85090	ES150	ES36	1-5/8"	C	25.31	15.52	9.79	YES	YES	943	99
85180	ES150	ES36	1-5/8"	C	20.94	13.83	7.11	YES	YES	681	283
85181	ES150	ES150	1-5/8"	C	26.33	17.06	9.27	YES	YES	681	285
89449	ES150	ES150	1-5/8"	G	23.25	14.9	8.35	YES	NO	1519‡	324
85918	ES150	ES150	1-5/8"	G	22.97	14.58	8.39	YES	NO	1726	412
85958	ES150	ES150	1-5/8"	G	22.89	14.5	8.39	YES	YES	1926	281

\* Damping force, in pounds, to either extend or collapse the shock absorber at an average operating velocity. Fuerza de amortiguación en libras para extender o comprimir el amortiguador a una velocidad de operación promedio. La puissance d'amortissement en poids de l'amortisseur, soit comprimé, doit détendu, à une vitesse de fonctionnement moyenne.

† At bumper contact / Al contacto con el tope de goma / Au contact avec le butoir

‡ For GasSLX Series, forces are at the "Firm" (F) setting. / Para la serie GasSLX, las fuerzas estan ajustada en (F) "Firme". / Pour la série GasSLX, le réglage de la force est sur «Firme» (F)

**SPECIFICATIONS BY END MOUNT**  
**ESPECIFICACIONES POR TIPO DE MONTAJE**  
**SPECIFICATIONS PAR FIXATION DES EXTRÉMITÉS**

Gabriel	Mounting		Bore	External Diameter Illustration	Lengths			Dust Tube	Recoil Cutoff	Controls*	
	Upper	Lower			Extended	Collapsed	Stroke			Rebound	Compression
89503	ES150	ES150	1-5/8"	G	21.28	13.72	7.56	YES	NO	1033‡	123
85106	ES150	ES150	1-5/8"	C	20.03	12.89	7.14	YES	YES	1054	109
85119	ES150	ES150	1-5/8"	C	21.39	13.81	7.68	YES	YES	1387	185
85922	ES150	ES150	1-5/8"	G	21.19	13.53	7.66	YES	NO	878	185
85920	ES150	ES150	1-5/8"	G	21.16	13.57	7.59	YES	NO	845	49
85959	ES150	ES150	1-5/8"	G	21.16	13.57	7.59	YES	YES	1021	123
85092	ES150	S21	1-5/8"	C	21.95	15.04	6.89	YES	YES	1597	138
83066	ES153	ES153	1-3/8"	A	11.15†	9.2†	2.78	YES	YES	599	221
83901	ES153	ES153	1-3/8"	A	11.15†	9.2†	2.78	YES	YES	509	204
85984	ES158	ES150	1-5/8"	G	25.44	15.96	9.48	YES	YES	2248	1168
85125	ES158	ES159	1-5/8"	C	26.9	16.64	10.26	YES	YES	1479	183
85724	ES158	ES159	1-5/8"	D	22.81	14.51	8.3	YES	YES	1235	454
89443	ES158	ES159	1-5/8"	G	22.19	14.66	7.53	YES	YES	1206‡	466
85331	ES158	ES159	1-5/8"	D	19.62	12.85	6.77	YES	YES	1757	396
85335	ES158	ES159	1-5/8"	D	19.62	12.85	6.77	YES	YES	827	107
85126	ES158	S21	1-5/8"	C	21.76	13.63	8.13	YES	YES	1086	215
87019	ES160	ES160	2-1/16"	E	24.84	15.85	8.9	YES	YES	2972	665
87017	ES160	ES160	2-1/16"	E	23.35	15.31	8.07	YES	YES	1876	220
89461	ES160	ES160	1-5/8"	G	19.96	13.58	6.38	YES	YES	897‡	103
85188	ES161	ES162	1-5/8"	C	25.31	15.52	9.79	YES	YES	1074	255
85088	ES161	ES162	1-5/8"	C	25.31	15.52	9.79	YES	YES	616	178
85061	ES161	ES162	1-5/8"	C	24.76	15.25	9.51	YES	YES	1216	195
85066	ES161	ES162	1-5/8"	C	24.64	15.25	9.39	YES	YES	812	322
85205	ES161	ES162	1-5/8"	C	22.41	14.69	7.72	YES	YES	518	422
89448	ES161	ES162	1-5/8"	G	24.61	15.66	8.94	YES	YES	782‡	323
89450	ES161	ES162	1-5/8"	G	24.61	15.66	8.94	YES	YES	1282‡	193
85065	ES161	S21	1-5/8"	C	28.05	17	11.05	YES	YES	1059	300
85083	ES162	S42	1-5/8"	C	27.81	16.53	11.28	YES	YES	1429	184
83142	ES162	S42	1-3/8"	A	23.92	14.49	9.43	YES	YES	367	131
83143	ES162	S42	1-3/8"	A	21.92	13.51	8.41	YES	YES	403	137
83025	ES163	ES163	1-3/8"	A	8.02	6.53	1.48	YES	YES	710	230
83049	ES163	ES163	1-3/8"	A	8.02	6.53	1.48	YES	YES	2879	705
83032	ES163	ES163	1-3/8"	A	7.85	6.36	1.49	NO	YES	779	135
83116	ES164	ES165	1-3/8"	A	23.81	14.68	9.12	YES	NO	354	300
83118	ES164	ES90	1-3/8"	A	24.45	14.71	9.74	YES	NO	410	311
83035	ES166	ES136	1-3/8"	A	13.04†	9.33	4.22	YES	YES	320	100
83067	ES166	ES136	1-3/16"	2" D/T	12.33†	9.27	3.56	YES	YES	424	101

\* Damping force, in pounds, to either extend or collapse the shock absorber at an average operating velocity. Fuerza de amortiguación en libras para extender o comprimir el amortiguador a una velocidad de operación promedio. La puissance d'amortissement en poids de l'amortisseur, soit comprimé, doit détendu, à une vitesse de fonctionnement moyenne.

† At bumper contact / Al contacto con el tope de goma / Au contact avec le butoir

‡ For GasSLX Series, forces are at the "Firm" (F) setting. / Para la serie GasSLX, las fuerzas están ajustadas en (F) "Firme". / Pour la série GasSLX, le réglage de la force est sur «Firme» (F)

**SPECIFICATIONS BY END MOUNT**  
**ESPECIFICACIONES POR TIPO DE MONTAJE**  
**SPÉCIFICATIONS PAR FIXATION DES EXTRÉMITÉS**

Gabriel	Mounting		Bore	External Diameter Illustration	Lengths			Dust Tube	Recoil Cutoff	Controls*	
	Upper	Lower			Extended	Collapsed	Stroke			Rebound	Compression
85670	ES175	ES175	1-5/8"	G	23.19	14.67	8.52	YES	YES	591	176
83029	ES168	ES169	1-5/8"	C	10.35	7.87	2.41	YES	NO	1303	1349
83910	ES169	ES169	1-3/8"	A	11.63†	9.35†	2.28	YES	YES	572	239
83040	ES171	ES172	1-3/8"	A	10.44†	8.4†	3	YES	YES	876	326
83057	ES171	ES172	1-3/8"	2-1/2" D/T	10.44†	8.4†	2.99	YES	YES	364	242
87015	ES173	ES173	45MM	E	15.51	11.18	4.33	YES	YES	4950	900
85737	ES173	ES173	1-5/8"	D	15.11	10.84	4.27	YES	YES	3066	782
89459	ES174	EB3	1-5/8"	G	25.63	16.14	9.49	YES	NO	1179‡	314
85070	ES174	EB3	1-5/8"	C	25.59	15.83	9.76	YES	NO	1100	310
85067	ES174	ES136	1-5/8"	C	30.54	18.15	12.39	YES	YES	676	170
89451	ES174	ES136	1-5/8"	G	30.39	18.54	11.86	YES	YES	645‡	172
85989	ES174	ES136	1-5/8"	G	20.78	13.15	7.63	YES	NO	1812	351
85084	ES174	ES136	1-5/8"	C	20.59	13.03	7.57	YES	NO	1145	407
89460	ES174	ES136	1-5/8"	G	20.58	13.03	7.55	YES	NO	997‡	384
85937	ES174	S43	1-5/8"	G	19.04	12.35	6.7	YES	YES	1479	337
85985	ES174	S43	1-5/8"	G	19.04	12.31	6.73	YES	YES	2068	723
85936	ES174	S43	1-5/8"	G	17.27	11.48	5.79	YES	YES	1479	337
89456	ES174	S43	1-5/8"	G	17.04	11.63	5.4	YES	YES	975‡	377
83063	ES175	ES136	1-3/8"	A	10.76†	9.26†	3.01	YES	YES	954	541
85955	ES175	ES150	1-5/8"	G	21.25	13.66	7.59	YES	YES	1034	397
85986	ES175	ES150	1-5/8"	G	21.25	13.66	7.59	YES	YES	1754	221
83243	ES175	ES175	1-3/8"	A	24.41	15.26	9.15	YES	YES	296	170
85120	ES175	ES175	1-5/8"	C	23.67	15.06	8.61	YES	NO	2083	519
83398	ES175	ES175	1-3/8"	A	23.23	15.38	7.85	YES	YES	293	168
85670	ES175	ES175	1-5/8"	G	23.19	14.67	8.52	YES	YES	591	176
85671	ES175	ES175	1-5/8"	G	21.02	13.8	7.22	YES	NO	3197	315
83163	ES175	ES175	1-3/8"	A	20.75	13.01	7.74	YES	NO	828	98
83175	ES175	ES175	1-3/8"	A	20.48	13.19	7.29	YES	NO	1245	156
83397	ES175	ES175	1-3/8"	A	18.67	11.91	6.76	YES	NO	303	101
85933	ES175	ES175	1-5/8"	G	18.27	12.72	5.54	YES	YES	1089	383
89454	ES175	ES175	1-5/8"	G	18.27	12.91	5.36	YES	YES	938‡	388
85081	ES175	S21	1-5/8"	C	23.44	14.33	9.11	YES	YES	1658	250
85080	ES175	S21	1-5/8"	C	22.51	13.77	8.74	YES	NO	447	138
85031	ES176	EB2	1-5/8"	C	25.63	15.87	9.76	YES	NO	941	257
85642	ES177	ES90	1-5/8"	G	22.52	14.52	8	YES	YES	1920	309
85923	ES177	ES161	1-5/8"	G	22.52	14.52	8	YES	YES	1940	221

\* Damping force, in pounds, to either extend or collapse the shock absorber at an average operating velocity. Fuerza de amortiguación en libras para extender o comprimir el amortiguador a una velocidad de operación promedio. La puissance d'amortissement en poids de l'amortisseur, soit comprimé, soit détendu, à une vitesse de fonctionnement moyenne.

† At bumper contact / Al contacto con el tope de goma / Au contact avec le butoir

‡ For GasSLX Series, forces are at the "Firm" (F) setting. / Para la serie GasSLX, las fuerzas están ajustadas en (F) "Firme". / Pour la série GasSLX, le réglage de la force est sur «Firme» (F)

**SPECIFICATIONS BY END MOUNT**  
**ESPECIFICACIONES POR TIPO DE MONTAJE**  
**SPECIFICATIONS PAR FIXATION DES EXTRÉMITÉS**

Gabriel	Mounting		Bore	External Diameter Illustration	Lengths			Dust Tube	Recoil Cutoff	Controls*	
	Upper	Lower			Extended	Collapsed	Stroke			Rebound	Compression
85931	ES177	ES161	1-5/8"	G	22.52	14.52	8	YES	YES	1435	220
89458	ES177	ES161	1-5/8"	G	22.48	14.6	7.88	YES	YES	1575‡	222
85672	ES177	ES161	1-5/8"	G	22.44	14.55	7.89	YES	YES	3051	245
85930	ES177	ES161	1-5/8"	G	17.86	12	5.86	YES	YES	1617	342
85932	ES178	ES150	1-5/8"	G	21.26	13.7	7.56	YES	YES	1102	430
89453	ES178	ES150	1-5/8"	G	21.14	13.93	7.21	YES	YES	860‡	435
85965	ES178	ES161	1-5/8"	G	24.24	15.15	9.09	YES	YES	2206	238
85966	ES178	ES161	1-5/8"	G	23.25	14.64	8.62	YES	YES	2206	238
85967	ES178	ES176	1-5/8"	G	23.93	14.86	9.07	YES	YES	2206	238
85961	ES178	ES176	1-5/8"	G	22.83	14.17	8.66	YES	YES	2206	240
85962	ES178	ES176	1-5/8"	G	21.8	13.66	8.15	YES	YES	2206	240
85980	ES179	ES179	1-5/8"	G	31.17	18.66	12.52	YES	YES	582	138
83148	ES179	ES179	1-3/8"	A	30	17.83	12.17	YES	YES	604	149
85978	ES179	ES179	1-5/8"	G	29.84	18.16	11.69	YES	YES	582	138
85638	ES179	ES179	1-5/8"	G	28.58	17.4	11.18	YES	YES	643	138
83147	ES179	ES179	1-3/8"	A	28.54	17.4	11.15	YES	YES	358	128
83166	ES179	ES179	1-3/8"	A	25.28	15.78	9.49	YES	YES	622	132
83168	ES179	ES179	1-3/8"	A	25.28	15.78	9.49	YES	YES	246	88
83396	ES179	ES179	1-3/8"	A	20.75	14.04	6.71	YES	YES	583	334
85377	ES182	ES182	1-5/8"	D	23.8	14.84	8.96	YES	YES	1937	570
85378	ES182	ES182	1-5/8"	D	23.8	14.84	8.96	YES	YES	1110	240
85956	ES183	ES184	1-5/8"	G	30.65	18.77	11.88	YES	YES	979	373
83053	ES185	ES185	1-3/8"	A	10.91	7.93	2.98	YES	YES	968	214
83054	ES185	ES185	1-3/8"	A	10.28	7.56	2.72	YES	YES	1004	184
83052	ES185	ES185	1-3/8"	2-1/2" D/T	9.41	7.19	2.23	YES	NO	1101	149
83062	ES185	S42	1-3/8"	A	12.71	9.18	3.53	YES	NO	704	153
85739	ES187	ES187	1-5/8"	D	20.73	13.54	7.19	YES	YES	3247	334
85341	ES188	S21	1-5/8"	D	30.96	18.1	12.86	YES	YES	1807	333
85970	ES188	S21	1-5/8"	G	27.23	16.44	10.79	YES	YES	1092	147
85340	ES188	S21	1-5/8"	D	26.46	15.85	10.61	YES	YES	1807	165
83391	ES190	ES190	1-3/8"	A	25.52	15.61	9.91	YES	NO	590	105
86203	ES193	ES193	45 MM	D	16.88	11.61	5.27	YES	YES	4238	910
86202	ES193	ES193	45 MM	D	14.52	10.43	4.09	YES	YES	4238	688
86201	ES193	ES193	45 MM	D	13.26	9.94	3.32	YES	YES	4238	688
86200	ES194	ES194	45 MM	D	14.24	10.45	3.79	YES	YES	4238	688
83065	ES206	ES171	1-5/8"	G	12.52	9.32	3.2	YES	YES	680	184
83003	S1	BP7	1-3/8"	A	11.76	8.95†	3.4	YES	YES	248	100
83161	S1	EB1	1-3/8"	A	20.82	12.56	8.25	YES	NO	400	70

\* Damping force, in pounds, to either extend or collapse the shock absorber at an average operating velocity. Fuerza de amortiguación en libras para extender o comprimir el amortiguador a una velocidad de operación promedio. La puissance d'amortissement en poids de l'amortisseur, soit comprimé, doit détendu, à une vitesse de fonctionnement moyenne.

† At bumper contact / Al contacto con el tope de goma / Au contact avec le butoir

‡ For GasSLX Series, forces are at the "Firm" (F) setting. / Para la serie GasSLX, las fuerzas están ajustadas en (F) "Firme". / Pour la série GasSLX, le réglage de la force est sur «Firme» (F)

**SPECIFICATIONS BY END MOUNT**  
**ESPECIFICACIONES POR TIPO DE MONTAJE**  
**SPÉCIFICATIONS PAR FIXATION DES EXTRÉMITÉS**

Gabriel	Mounting		Bore	External Diameter Illustration	Lengths			Dust Tube	Recoil Cutoff	Controls*	
	Upper	Lower			Extended	Collapsed	Stroke			Rebound	Compression
83518	S1	EB2	1-3/16"		24.4	14.26	10.14	YES	NO	153	82
83515	S1	EB2	1-3/16"		23.34	13.89	9.45	YES	NO	643	205
83400	S1	S1	1-3/16"	F	22.02	12.82	9.2	YES	NO	301	120
83014	S1	S1	1-3/8"	A	10.48	7.11	3.37	NO	NO	544	501
83317	S16	ES90	1-3/8"	B	27.03	16	11.34	YES	YES		
83301	S16	ES90	1-3/8"	B	24.52	14.74	9.78	YES	YES	653	86
83318	S16	S16	1-3/8"	B	22.53	13.5	9.03	YES	YES	323	77
83613	S16	S16	1-3/8"	A	21.04	12.76	8.28	YES	YES	601	242
85731	S21	EB3	1-5/8"	D	30.57	18.54	12.03	YES	YES	1517	293
85703	S21	EB3	1-5/8"	D	29.57	18.54	11.03	YES	YES	1435	186
85033	S21	EB3	1-5/8"	C	27.26	17.4	9.86	YES	YES	764	254
89427	S21	EB3	1-5/8"	G	27.19	17.62	9.57	YES	YES	794†	253
85317	S21	EB3	1-5/8"	D	27.18	17.42	9.76	YES	YES	764	254
85711	S21	EB3	1-5/8"	D	24.54	15.26	9.27	YES	YES	1435	208
87000	S21	EB3	2-1/16"	E	24.46	15.21	9.25	YES	YES	1332	300
85311	S21	EB3	1-5/8"	D	23.95	14.79	9.16	YES	YES	764	254
85988	S21	EB3	1-5/8"	G	23.84	14.87	8.97	YES	YES	1200	138
89424	S21	EB3	1-5/8"	G	23.73	15.14	8.59	YES	YES	794†	253
85710	S21	EB3	1-5/8"	D	23.45	15.1	8.34	YES	YES	994	248
85343	S21	EB3	1-5/8"	D	22.96	14.79	8.17	YES	YES	858	289
87016	S21	EB3	2-1/16"	E	21.17	13.91	7.26	YES	YES	1808	238
85009	S21	ES36	1-5/8"	C	23.56	14.4	9.16	YES	YES	857	144
83134	S21	ES36	1-3/8"	A	22.27	13.51	8.77	YES	NO	430	49
85921	S21	ES36	1-5/8"	G	22.07	13.57	8.5	YES	NO	2053	339
85316	S21	ES36	1-5/8"	D	20.61	12.82	7.8	YES	NO	943	443
85351	S21	ES36	1-5/8"	D	20.61	12.82	7.79	YES	NO	1887	259
89426	S21	ES36	1-5/8"	G	20.46	13.05	7.41	YES	NO	926†	419
85056	S21	ES36	1-5/8"	C	20.15	12.87	7.28	YES	YES	732	114
89441	S21	ES36	1-5/8"	G	20.14	13.06	7.08	YES	YES	761†	126
85935	S21	ES36	1-5/8"	G	18.7	11.92	6.78	YES	NO	1054	419
85319	S21	ES150	1-5/8"	D	22.22	13.93	8.3	YES	YES	988	454
89428	S21	ES150	1-5/8"	G	22	14.27	7.72	YES	YES	958†	446
83395	S21	ES178	1-3/8"	A	27.19	16.28	10.91	YES	NO	616	105
85709	S21	S21	1-5/8"	D	31.64	18.36	13.28	YES	YES	700	203
85727	S21	S21	1-5/8"	D	29.88	17.34	12.54	YES	YES	783	111
83136	S21	S21	1-3/8"	A	29.31	16.8	12.51	YES	NO	914	65
83106	S21	S21	1-3/8"	A	29.25	16.76	12.49	YES	NO	451	80
85048	S21	S21	1-5/8"	C	29.16	16.88	12.28	YES	NO	432	106

\* Damping force, in pounds, to either extend or collapse the shock absorber at an average operating velocity. Fuerza de amortiguación en libras para extender o comprimir el amortiguador a una velocidad de operación promedio. La puissance d'amortissement en poids de l'amortisseur, soit comprimé, doit détendu, à une vitesse de fonctionnement moyenne.

† At bumper contact / Al contacto con el tope de goma / Au contact avec le butoir

‡ For GasSLX Series, forces are at the "Firm" (F) setting. / Para la serie GasSLX, las fuerzas estan ajustada en (F) "Firme". / Pour la série GasSLX, le réglage de la force est sur «Firme» (F)

**SPECIFICATIONS BY END MOUNT**  
**ESPECIFICACIONES POR TIPO DE MONTAJE**  
**SPÉCIFICATIONS PAR FIXATION DES EXTRÉMITÉS**

Gabriel	Mounting		Bore	External Diameter Illustration	Lengths			Dust Tube	Recoil Cutoff	Controls*	
	Upper	Lower			Extended	Collapsed	Stroke			Rebound	Compression
85318	S21	S21	1-5/8"	D	27.37	16.36	11.01	YES	YES	1372	192
85722	S21	S21	1-5/8"	D	27.16	16.41	10.76	YES	YES	1264	369
85069	S21	S21	1-5/8"	C	26.31	15.97	10.33	YES	YES	762	255
89455	S21	S21	1-5/8"	G	26.31	16.03	10.28	YES	YES	791‡	276
85328	S21	S21	1-5/8"	D	25.64	15.36	10.28	YES	NO	930	383
85071	S21	S21	1-5/8"	C	25.57	15.02	10.55	YES	NO	610	107
85049	S21	S21	1-5/8"	C	25.53	15	10.53	YES	NO	597	107
85085	S21	S21	1-5/8"	C	24.95	14.67	10.23	YES	NO	970	101
85728	S21	S21	1-5/8"	D	24.37	14.86	9.51	YES	YES	1435	510
83456	S21	S21	1-3/8"	B	24.03	14.25	9.78	YES	YES	566	80
85706	S21	S21	1-5/8"	D	23.65	14.24	9.41	YES	YES	1086	696
85707	S21	S21	2-1/16"	D	23.65	14.4	9.25	YES	YES	1761	986
87011	S21	S21	2-1/16"	E	23.65	14.4	9.25	YES	YES	1750	1050
87012	S21	S21	2-1/16"	E	23.65	14.4	9.25	YES	YES	650	364
87013	S21	S21	2-1/16"	E	23.65	14.4	9.25	YES	YES	1075	585
85325	S21	S21	1-5/8"	D	23.64	14.36	9.28	YES	NO	1024	240
89447	S21	S21	1-5/8"	G	23.63	14.69	8.94	YES	YES	702‡	241
85347	S21	S21	1-5/8"	D	23.62	14.22	9.4	YES	YES	961	122
85705	S21	S21	1-5/8"	D	23.62	14.23	9.39	YES	YES	639	436
85342	S21	S21	1-5/8"	D	23.28	13.99	9.29	YES	NO	893	188
83102	S21	S21	1-3/8"	A	22.89	13.54	9.35	YES	YES	513	333
85324	S21	S21	1-5/8"	D	22.14	13.61	8.53	YES	NO	579	114
85346	S21	S21	1-5/8"	D	22.12	13.48	8.64	YES	YES	2016	285
85027	S21	S21	1-5/8"	C	21.59	13.05	8.54	YES	NO	1008	539
89418	S21	S21	1-5/8"	G	21.44	13.19	8.25	YES	NO	1266‡	515
695406	S21	S21	2-1/16"	E	21.39	13.26	8.13	YES	YES	1854	274
85124	S21	S21	1-5/8"	C	20.91	12.9	8.01	YES	YES	1086	222
85708	S21	S21	1-5/8"	D	20.63	12.85	7.78	YES	YES	914	204
85745	S21	S21	1-5/8"	D	19.88	12.34	7.54	YES	YES	3064	231
85746	S21	S21	1-5/8"	D	19.88	12.34	7.54	YES	YES	1754	167
83103	S21	S21	1-3/8"	A	19.66	11.93	7.74	YES	YES	517	301
85326	S21	S21	1-5/8"	D	19.64	12.36	7.28	YES	NO	799	142
85902	S21	S21	1-5/8"	G	19.03	12.09	6.93	YES	YES	1441	267
85336	S21	S21	1-5/8"	D	18.76	11.86	6.9	YES	NO	861	200
89423	S21	S21	1-5/8"	G	18.67	12.21	6.46	YES	YES	1352‡	573
85310	S21	S21	1-5/8"	D	18.63	11.71	6.92	YES	YES	1379	578
85900	S21	S21	1-5/8"	G	17.33	11.23	6.11	YES	YES	1467	337
87007	S21	S21	2-1/16"	E	15.65	10.4	5.25	YES	YES	879	253

\* Damping force, in pounds, to either extend or collapse the shock absorber at an average operating velocity. Fuerza de amortiguación en libras para extender o comprimir el amortiguador a una velocidad de operación promedio. La puissance d'amortissement en poids de l'amortisseur, soit comprimé, doit détendu, à une vitesse de fonctionnement moyenne.

† At bumper contact / Al contacto con el tope de goma / Au contact avec le butoir

‡ For GasSLX Series, forces are at the "Firm" (F) setting. / Para la serie GasSLX, las fuerzas están ajustadas en (F) "Firme". / Pour la série GasSLX, le réglage de la force est sur «Firme» (F)

**SPECIFICATIONS BY END MOUNT**  
**ESPECIFICACIONES POR TIPO DE MONTAJE**  
**SPÉCIFICATIONS PAR FIXATION DES EXTRÉMITÉS**

Gabriel	Mounting		Bore	External Diameter Illustration	Lengths			Dust Tube	Recoil Cutoff	Controls*	
	Upper	Lower			Extended	Collapsed	Stroke			Rebound	Compression
85701	S21	S21	1-5/8"	D	15.64	10.36	5.28	YES	YES	914	204
83178	S38	ES83	1-3/8"	A	21.95	13.26	8.69	YES	NO	690	275
83177	S40	EB1	1-3/8"	A	14.99†	10.12	5.38	YES	NO	690	275
83114	S40	ES35	1-3/8"	A	23.02	13.78	9.24	YES	NO	450	102
83105	S40	ES179	1-3/8"	A	31.91	18.3	13.61	YES	NO	559	150
83162	S40	ES190	1-3/8"	A	24.35	14.69	9.67	YES	NO	877	52
85333	S42	ES36	1-5/8"	D	20.65	12.98	7.67	YES	YES	1241	534
85332	S42	ES36	1-5/8"	D	20.64	12.98	7.66	YES	YES	2351	967
83244	S43	ES175	1-3/8"		27.28	16.38	10.9	YES	NO	502	112
85182	S43	S43	1-5/8"	C	26.86	16.04	10.82	YES	NO	708	232
85649	S62	ES34	1-5/8"	G	23.16	16.46	6.7	YES	NO	875	421

\* Damping force, in pounds, to either extend or collapse the shock absorber at an average operating velocity. Fuerza de amortiguación en libras para extender o comprimir el amortiguador a una velocidad de operación promedio. La puissance d'amortissement en poids de l'amortisseur, soit comprimé, soit détendu, à une vitesse de fonctionnement moyenne.

† At bumper contact / Al contacto con el tope de goma / Au contact avec le butoir

‡ For GasSLX Series, forces are at the "Firm" (F) setting. / Para la serie GasSLX, las fuerzas están ajustadas en (F) "Firme". / Pour la série GasSLX, le réglage de la force est sur «Firme» (F)

**SPECIFICATIONS BY PART NUMBER  
ESPECIFICACIONES POR NÚMERO DE PARTE  
SPÉCIFICATIONS PAR NUMÉRO DE PIÈCE**

Gabriel	Mounting		Bore	External Diameter Illustration	Lengths			Dust Tube	Recoil Cutoff	Controls*	
	Upper	Lower			Extended	Collapsed	Stroke			Rebound	Compression
619501	ES1	ES1	1"		32.65†	19.69	13.22	NO	NO	55	27
632147	0	0	1-3/16"		22.45	14.1	8.35	NO	NO		
646155	ES36	ES36	1-3/16"		22.45	14.1	8.35	YES	NO		
646177	ES36	ES36	1-3/16"		22.45	14.1	8.35	NO	NO		
665472	ES36	ES36	1-5/8"	G	25.14	15.61	9.53	NO	NO	925	977
665937	ES36	ES36	1-5/8"	G	22.91	16.09	6.82	YES	NO		
695406	S21	S21	2-1/16"	E	21.39	13.26	8.13	YES	YES	1854	274
83001	ES149	EB1	1-3/8"	A	10.45†	8.41†	3	YES	YES	793	363
83002	ES10	ES10	1-3/8"	A	11.65	8.66	3	YES	YES	3112	590
83003	S1	BP7	1-3/8"	A	11.76	8.95†	3.4	YES	YES	248	100
83004	ES35	ES136	1"	2" D/T	9.36†	7.29	2.32	YES	YES	539	324
83005	BP8	S10	1-3/16"	2" D/T	7.34	5.87	1.47	YES	NO	858	216
83006	ES149	EB1	1-3/8"	A	10.71	8.52†	2.78	YES	YES	525	182
83007	EB1	EB1	1-3/8"	A	18.55	11.67	6.87	NO	NO	489	343
83008	ES136	ES136	1-3/8"	A	13†	10.13†	4	YES	YES	699	307
83009	ES149	ES149	1-3/8"	A	10.45†	8.41†	3	YES	YES	793	363
83010	ES24	ES24	1"	2" D/T	14.15†	9.33	5.07	YES	YES	188	70
83011	EB1	EB1	1-3/8"	A	11.55†	8.48	3.61	YES	YES	738	330
83012	EB1	EB1	1-3/8"	A	11.07†	8.21	3.37	YES	YES	738	330
83013	BP8	BP8	1-3/16"	2" D/T	7.66	6.63†	1.7	YES	NO	646	480
83014	S1	S1	1-3/8"	A	10.48	7.11	3.37	NO	NO	544	501
83015	BP8	S1	1-3/8"	A	9.84	7.59	2.25	YES	YES	735	430
83016	ES10	ES10	1"	1-5/8"	11.51	8.14	3.37	NO	YES	506	139
83017	ES149	ES149	1-3/8"	A	10.95	8.41†	3.13	YES	YES	353	138
83018	ES24	S10	1-3/8"	A	10.3†	8.42†	3.24	YES	YES	515	174
83019	ES24	S10	1-3/8"	A	9.48	8.21†	2.29	YES	YES	509	121
83020	ES91	ES91	1-3/8"	A	9.41	7.17	2.24	YES	YES	796	255
83021	ES10	ES10	1-3/8"	A	9.41	7.4	2.01	YES	YES	745	315
83022	ES24	ES24	1"	2" D/T	14.28	9.33	4.95	YES	NO	840	152
83023	ES10	ES181	1"	1-5/8"	8.7	7.09†	2.14	NO	YES	484	157
83024	ES10	ES10	1-3/8"	2-1/2" D/T	11.65	8.66	3	YES	YES	811	320
83025	ES163	ES163	1-3/8"	A	8.02	6.53	1.48	YES	YES	710	230
83026	ES24	ES24	1-3/8"	A	13.11	9.12	3.99	YES	YES	602	104
83027	ES24	S10	1-3/8"	A	13.82	9.2	4.61	YES	YES	602	104
83028	ES86	ES167	1-3/8"	A	9.96	7.6	2.33	YES	YES	445	531
83029	ES168	ES169	1-5/8"	C	10.35	7.87	2.41	YES	NO	1303	1349
83030	ES136	ES136	1-3/8"	A	9.61†	7.61	2.5	YES	YES	308	87

\* Damping force, in pounds, to either extend or collapse the shock absorber at an average operating velocity. Fuerza de amortiguación en libras para extender o comprimir el amortiguador a una velocidad de operación promedio. La puissance d'amortissement en poids de l'amortisseur, soit comprimé, doit détendu, à une vitesse de fonctionnement moyenne.

† At bumper contact / Al contacto con el tope de goma / Au contact avec le butoir

‡ For GasSLX Series, forces are at the "Firm" (F) setting. / Para la serie GasSLX, las fuerzas están ajustadas en (F) "Firme". / Pour la série GasSLX, le réglage de la force est sur «Firme» (F)



**SPECIFICATIONS BY PART NUMBER  
ESPECIFICACIONES POR NÚMERO DE PARTE  
SPÉCIFICATIONS PAR NUMÉRO DE PIÈCE**

Gabriel	Mounting		Bore	External Diameter Illustration	Lengths			Dust Tube	Recoil Cutoff	Controls*	
	Upper	Lower			Extended	Collapsed	Stroke			Rebound	Compression
83031	ES10	ES10	1-3/8"	2-1/2" D/T	11.54	8.66	2.88	YES	YES	811	314
83032	ES163	ES163	1-3/8"	A	7.85	6.36	1.49	NO	YES	779	135
83033	ES53	ES53	1-3/8"	A	13.99	10.37	3.62	YES	YES	494	312
83034	ES115	ES115	1-3/16"	1-5/8"	10.04†	7.32	2.97	NO	YES	430	129
83035	ES166	ES136	1-3/8"	A	13.04†	9.33	4.22	YES	YES	320	100
83038	ES149	EB1	1-3/8"	A	10.45†	8.41†	3	YES	YES	336	242
83039	ES149	ES149	1-3/8"	A	10.44†	8.4†	3	YES	YES	876	326
83040	ES171	ES172	1-3/8"	A	10.44†	8.4†	3	YES	YES	876	326
83041	BP27	S10	1-3/8"	A	10.51†	8.34†	3.02	YES	YES	486	189
83042	ES136	ES136	1-3/8"	A	9.89†	8.52†	2.39	YES	YES	954	541
83044	ES27	ES164	1-3/8"	A	10.91	7.93	2.98	YES	YES	789	296
83045	ES19	S10	1-3/8"	A	11.53†	8.58†	3.81	YES	NO	510	153
83046	ES10	ES181	1-3/16"		9.23†	7.62†	2.73	NO	YES	514	173
83047	ES149	EB1	1-3/8"	A	11.78†	9.74†	3	YES	YES	364	314
83048	ES86	ES167	1-3/8"	A	9.97	8.43†	2.37	YES	YES	904	415
83049	ES163	ES163	1-3/8"	A	8.02	6.53	1.48	YES	YES	2879	705
83050	ES19	S10	1-3/8"	A	10.43†	8.38†	2.9	YES	YES	599	321
83051	ES10	ES10	1-3/8"	2-1/2" D/T	9.41	7.4	2.01	YES	YES	579	163
83052	ES185	ES185	1-3/8"	2-1/2" D/T	9.41	7.19	2.23	YES	NO	1101	149
83053	ES185	ES185	1-3/8"	A	10.91	7.93	2.98	YES	YES	968	214
83054	ES185	ES185	1-3/8"	A	10.28	7.56	2.72	YES	YES	1004	184
83056	ES136	ES136	1-5/8"	C	11.53	8.63	2.89	YES	YES	3830	737
83057	ES171	ES172	1-3/8"	2-1/2" D/T	10.44†	8.4†	2.99	YES	YES	364	242
83058	ES19	S10	1-3/8"	A	10.43†	8.38†	2.9	YES	YES	742	243
83059	ES35	ES35	1-3/8"	A	12.06†	8.68	3.88	YES	YES	738	350
83060	EB	BP7	1-3/8"	A	9.76	7.98†	2.25	NO	YES	431	441
83061	ES10	ES10	1-3/8"	2-1/2" D/T	9.41	7.4	2.01	YES	YES	1030	220
83062	ES185	S42	1-3/8"	A	12.71	9.18	3.53	YES	NO	704	153
83063	ES175	ES136	1-3/8"	A	10.76†	9.26†	3.01	YES	YES	954	541
83064	ES149	ES149	1-3/8"	A	10.41†	8.36†	2.99	YES	YES	635	323
83065	ES206	ES171	1-5/8"	G	12.52	9.32	3.2	YES	YES	680	184
83066	ES153	ES153	1-3/8"	A	11.15†	9.2†	2.78	YES	YES	599	221
83067	ES166	ES136	1-3/16"	2" D/T	12.33†	9.27	3.56	YES	YES	424	101
83081	ES126	ES172	1-3/8"	A	13.39	9.98†	4	YES	YES	1004	232
83100	ES90	ES90	1-3/8"	A	26.6	16.11	10.49	YES	YES	481	142
83101	ES90	ES90	1-3/8"	A	24.63	15.13	9.49	YES	YES	481	142
83102	S21	S21	1-3/8"	A	22.89	13.54	9.35	YES	YES	513	333

\* Damping force, in pounds, to either extend or collapse the shock absorber at an average operating velocity. Fuerza de amortiguación en libras para extender o comprimir el amortiguador a una velocidad de operación promedio. La puissance d'amortissement en poids de l'amortisseur, soit comprimé, doit détendu, à une vitesse de fonctionnement moyenne.

† At bumper contact / Al contacto con el tope de goma / Au contact avec le butoir

‡ For GasSLX Series, forces are at the "Firm" (F) setting. / Para la serie GasSLX, las fuerzas están ajustadas en (F) "Firme". / Pour la série GasSLX, le réglage de la force est sur «Firme» (F)

**SPECIFICATIONS BY PART NUMBER**  
**ESPECIFICACIONES POR NÚMERO DE PARTE**  
**SPÉCIFICATIONS PAR NUMÉRO DE PIÈCE**

Gabriel	Mounting		Bore	External Diameter Illustration	Lengths			Dust Tube	Recoil Cutoff	Controls*	
	Upper	Lower			Extended	Collapsed	Stroke			Rebound	Compression
83103	S21	S21	1-3/8"	A	19.66	11.93	7.74	YES	YES	517	301
83104	EB3	EB3	1-3/8"	A	28.24	17.12	11.12	YES	NO	698	133
83105	S40	ES179	1-3/8"	A	31.91	18.3	13.61	YES	NO	559	150
83106	S21	S21	1-3/8"	A	29.25	16.76	12.49	YES	NO	451	80
83107	EB2	EB2	1-3/8"	A	31.66	18.4	13.25	YES	NO	352	77
83109	ES36	S42	1-3/8"	A	26.17	15.93	10.24	YES	YES	345	78
83110	ES36	S42	1-3/8"	A	22.94	14.31	8.63	YES	YES	450	143
83111	ES36	S42	1-3/8"	A	26.17	15.93	10.24	YES	YES	560	141
83112	ES36	S42	1-3/8"	A	21.52	13.41	8.11	YES	YES	1064	343
83113	ES36	EB3	1-3/8"	A	20.47	13.46	7.01	YES	YES	997	238
83114	S40	ES35	1-3/8"	A	23.02	13.78	9.24	YES	NO	450	102
83115	ES36	EB3	1-3/8"	A	16.19	13.32	4.87	YES	YES	997	238
83116	ES164	ES165	1-3/8"	A	23.81	14.68	9.12	YES	NO	354	300
83117	EB4	EB1	1-3/8"	A	23.98	14.47	9.51	YES	NO	354	300
83118	ES164	ES90	1-3/8"	A	24.45	14.71	9.74	YES	NO	410	311
83119	EB4	ES165	1-3/8"	A	23.96	14.84	9.12	YES	NO	354	300
83120	ES120	S21	1-3/8"	A	22.17	13.66	8.51	YES	YES	779	164
83121	ES36	ES36	1-3/8"	A	30.25	18.32	11.93	YES	YES	689	126
83122	ES36	ES36	1-3/8"	A	25.28	15.79	9.49	YES	YES	661	201
83123	ES36	ES36	1-3/8"	A	26.65	16.41	10.24	YES	YES	589	119
83124	ES36	ES36	1-3/8"	A	21.65	13.77	7.88	YES	YES	750	137
83125	ES36	ES36	1-3/8"	A	28.15	17.16	10.99	YES	YES	625	115
83126	ES36	ES36	1-3/8"	A	24.41	15.27	9.14	YES	YES	625	115
83127	ES36	ES36	1-3/8"	A	20.16	13.14	7.01	YES	YES	940	218
83128	ES36	ES36	1-3/8"	A	16.89	11.53	5.36	YES	YES	940	218
83130	ES36	ES36	1-3/8"	A	18.03	12.04	5.99	YES	YES	871	177
83131	ES83	ES83	1-3/8"	A	27.8	18.18	9.62	YES	NO	212	129
83132	EB3	EB3	1-3/8"	A	25.24	15.5	9.74	YES	NO	828	150
83134	S21	ES36	1-3/8"	A	22.27	13.51	8.77	YES	NO	430	49
83135	ES90	ES90	1-3/8"	A	19.49	12.38	7.11	YES	NO	519	121
83136	S21	S21	1-3/8"	A	29.31	16.8	12.51	YES	NO	914	65
83137	ES36	ES36	1-3/8"	A	30.04	17.79	12.25	YES	YES	517	132
83138	ES36	S42	1-3/8"	A	23.55	14.42	9.12	YES	YES	997	231
83140	EB3	EB3	1-3/8"	A	25.28	15.53	9.75	YES	NO	738	88
83141	EB3	EB3	1-3/8"	A	25.27	15.52	9.75	YES	NO	408	113
83142	ES162	S42	1-3/8"	A	23.92	14.49	9.43	YES	YES	367	131
83143	ES162	S42	1-3/8"	A	21.92	13.51	8.41	YES	YES	403	137

\* Damping force, in pounds, to either extend or collapse the shock absorber at an average operating velocity. Fuerza de amortiguación en libras para extender o comprimir el amortiguador a una velocidad de operación promedio. La puissance d'amortissement en poids de l'amortisseur, soit comprimé, doit détendu, à une vitesse de fonctionnement moyenne.

† At bumper contact / Al contacto con el tope de goma / Au contact avec le butoir

‡ For GasSLX Series, forces are at the "Firm" (F) setting. / Para la serie GasSLX, las fuerzas están ajustadas en (F) "Firme". / Pour la série GasSLX, le réglage de la force est sur «Firme» (F)

**SPECIFICATIONS BY PART NUMBER**  
**ESPECIFICACIONES POR NÚMERO DE PARTE**  
**SPÉCIFICATIONS PAR NUMÉRO DE PIÈCE**

Gabriel	Mounting		Bore	External Diameter Illustration	Lengths			Dust Tube	Recoil Cutoff	Controls*	
	Upper	Lower			Extended	Collapsed	Stroke			Rebound	Compression
83144	ES36	ES36	1-3/8"	A	23.78	15.03	8.74	YES	YES	596	93
83145	ES83	ES83	1-3/8"	A	19.93	12.32	7.54	YES	NO	479	153
83146	ES90	ES83	1-3/8"	A	24.02	14.68	9.33	YES	YES	479	119
83147	ES179	ES179	1-3/8"	A	28.54	17.4	11.15	YES	YES	358	128
83148	ES179	ES179	1-3/8"	A	30	17.83	12.17	YES	YES	604	149
83149	ES36	ES36	1-3/8"	A	25.28	15.78	9.49	YES	YES	332	101
83150	ES36	ES36	1-3/8"	A	15.24	10.43	4.81	YES	YES	940	216
83153	ES34	ES34	1-3/8"	A	21.69	13.62	8.07	YES	YES	974	206
83154	ES120	S21	1-3/8"	A	20.78	12.72	8.06	YES	YES	599	140
83155	ES34	ES34	1-3/8"	A	21.69	13.62	8.07	YES	YES	507	80
83156	ES90	ES90	1-3/8"	A	18.55	11.91	6.64	YES	NO	778	135
83157	ES36	ES90	1-3/8"	A	26.38	15.76	10.61	YES	NO	446	303
83158	ES22	ES22	1-3/8"	A	12.96	8.97	4	YES	NO	783	484
83159	EB2	EB2	1-3/8"	A	21.85	13.56	8.29	YES	NO	658	149
83160	ES128	ES36	1-3/8"	A	24.31	14.9	9.37	YES	YES	920	161
83161	S1	EB1	1-3/8"	A	20.82	12.56	8.25	YES	NO	400	70
83162	S40	ES190	1-3/8"	A	24.35	14.69	9.67	YES	NO	877	52
83163	ES175	ES175	1-3/8"	A	20.75	13.01	7.74	YES	NO	828	98
83164	ES36	ES165	1-3/8"	C	24.22	14.59	9.63	YES	NO	426	274
83166	ES179	ES179	1-3/8"	A	25.28	15.78	9.49	YES	YES	622	132
83167	ES90	ES90	1-3/8"	A	19.49	12.38	7.11	YES	NO	285	90
83168	ES179	ES179	1-3/8"	A	25.28	15.78	9.49	YES	YES	246	88
83169	ES90	ES90	1-3/8"	A	18.55	11.91	6.64	YES	NO	599	171
83171		ES36	1-3/8"	A	23.98	14.51	9.47	YES	YES	513	146
83174	ES128	ES36	1-3/8"	A	24.31	14.9	9.37	YES	YES	795	160
83175	ES175	ES175	1-3/8"	A	20.48	13.19	7.29	YES	NO	1245	156
83176	ES36	ES36	1-3/8"	A	26.62	15.96	10.66	NO	NO	406	275
83177	S40	EB1	1-3/8"	A	14.99†	10.12	5.38	YES	NO	690	275
83178	S38	ES83	1-3/8"	A	21.95	13.26	8.69	YES	NO	690	275
83180	ES90	ES83	1-3/8"		30.2	21.24	8.96	YES	NO	909	204
83200	EB2	EB2	1-3/8"	A	24.51	15.1	9.53	YES	NO	806	370
83203	ES36	ES36	1-3/8"	A	17.1	11.36	5.74	YES	YES	609	114
83204	ES36	ES36	1-3/8"	A	20.14	12.86	7.28	YES	YES	451	110
83205	ES36	ES36	1-3/8"	A	29.69	17.69	12	YES	YES	660	76
83207	ES36	ES36	1-3/8"	A	21.64	13.61	8.03	YES	YES	553	143
83209	ES36	ES36	1-3/8"	A	29.64	17.61	12.03	YES	YES	670	78
83214	EB3	EB3	1-3/8"	A	19.64	12.86	6.78	YES	YES	269	90

\* Damping force, in pounds, to either extend or collapse the shock absorber at an average operating velocity. Fuerza de amortiguación en libras para extender o comprimir el amortiguador a una velocidad de operación promedio. La puissance d'amortissement en poids de l'amortisseur, soit comprimé, doit détendu, à une vitesse de fonctionnement moyenne.

† At bumper contact / Al contacto con el tope de goma / Au contact avec le butoir

‡ For GasSLX Series, forces are at the "Firm" (F) setting. / Para la serie GasSLX, las fuerzas están ajustadas en (F) "Firme". / Pour la série GasSLX, le réglage de la force est sur «Firme» (F)

**SPECIFICATIONS BY PART NUMBER**  
**ESPECIFICACIONES POR NÚMERO DE PARTE**  
**SPÉCIFICATIONS PAR NUMÉRO DE PIÈCE**

Gabriel	Mounting		Bore	External Diameter Illustration	Lengths			Dust Tube	Recoil Cutoff	Controls*	
	Upper	Lower			Extended	Collapsed	Stroke			Rebound	Compression
83215	EB3	EB3	1-3/8"	A	26.64	16.36	10.28	YES	YES	697	108
83216	EB2	EB2	1-3/8"	A	23.51	14.48	9.03	YES	YES	776	262
83217	EB3	EB3	1-3/8"	A	22.77	14.49	8.28	YES	YES	633	159
83218	ES36	ES36	1-3/8"	A	25.19	15.44	9.75	YES	YES	721	194
83219	EB2	EB2	1-3/8"	A	20.01	12.73	7.28	YES	YES	299	125
83221	ES36	ES36	1-3/8"	A	24.01	14.73	9.28	YES	YES	599	153
83225	EB3	EB3	1-3/8"	A	24.14	15.11	9.03	YES	YES	482	159
83242	ES36	ES36	1-3/8"	A	33.73	20.98	12.75	YES	YES	721	135
83243	ES175	ES175	1-3/8"	A	24.41	15.26	9.15	YES	YES	296	170
83244	S43	ES175	1-3/8"		27.28	16.38	10.9	YES	NO	502	112
83301	S16	ES90	1-3/8"	B	24.52	14.74	9.78	YES	YES	653	86
83303	EB7	ES36	1-3/8"	B	24.86	15.08	9.78	YES	YES	470	122
83304	EB7	ES36	1-3/8"	B	22.86	14.08	8.78	YES	YES	470	122
83308	EB2	EB2	1-3/8"	B	25.14	15.36	9.78	YES	YES	445	180
83309	EB2	EB2	1-3/8"	B	28.64	17.11	11.53	YES	YES	589	135
83310	ES36	ES36	1-3/8"	B	24.06	14.69	9.37	YES	NO	559	153
83312	EB2	EB2	1-3/8"	B	26.64	16.11	10.53	YES	YES	527	152
83314	EB2	EB2	1-3/8"	B	30.64	18.11	12.53	YES	YES	633	143
83317	S16	ES90	1-3/8"	B	27.03	16	11.34	YES	YES		
83318	S16	S16	1-3/8"	B	22.53	13.5	9.03	YES	YES	323	77
83353	EB3	S21	1-3/8"	B	24.84	15.06	9.78	YES	NO	432	214
83362	EB3	EB3	1-3/8"	B	27	16.25	10.75	YES	NO	539	202
83363	ES36	ES36	1-3/8"	A	16.46	11.35	5.11	YES	YES	1084	201
83364	ES90	ES83	1-3/8"	A	24.06	15.07	8.99	YES	YES	855	206
83389	ES36	ES36	1-3/8"	A	17.32	11.57	5.75	YES	YES	1084	228
83391	ES190	ES190	1-3/8"	A	25.52	15.61	9.91	YES	NO	590	105
83395	S21	ES178	1-3/8"	A	27.19	16.28	10.91	YES	NO	616	105
83396	ES179	ES179	1-3/8"		20.75	14.04	6.71	YES	YES	583	334
83397	ES175	ES175	1-3/8"	A	18.67	11.91	6.76	YES	NO	303	101
83398	ES175	ES175	1-3/8"	A	23.23	15.38	7.85	YES	YES	293	168
83400	S1	S1	1-3/16"	F	22.02	12.82	9.2	YES	NO	301	120
83401	EB1	EB1	1-3/16"	F	24.09	14.26	9.83	YES	NO	341	252
83404	EB2	EB2	1-3/16"	F	22.01	13.44	8.58	YES	NO	545	171
83456	S21	S21	1-3/8"	B	24.03	14.25	9.78	YES	YES	566	80
83515	S1	EB2	1-3/16"		23.34	13.89	9.45	YES	NO	643	205
83518	S1	EB2	1-3/16"		24.4	14.26	10.14	YES	NO	153	82
83519	EB2	EB2	1-3/16"	F	23.83	14.35	9.48	YES	NO	292	132

\* Damping force, in pounds, to either extend or collapse the shock absorber at an average operating velocity. Fuerza de amortiguación en libras para extender o comprimir el amortiguador a una velocidad de operación promedio. La puissance d'amortissement en poids de l'amortisseur, soit comprimé, doit détendu, à une vitesse de fonctionnement moyenne.

† At bumper contact / Al contacto con el tope de goma / Au contact avec le butoir

‡ For GasSLX Series, forces are at the "Firm" (F) setting. / Para la serie GasSLX, las fuerzas están ajustadas en (F) "Firme". / Pour la série GasSLX, le réglage de la force est sur «Firme» (F)

**SPECIFICATIONS BY PART NUMBER**  
**ESPECIFICACIONES POR NÚMERO DE PARTE**  
**SPÉCIFICATIONS PAR NUMÉRO DE PIÈCE**

Gabriel	Mounting		Bore	External Diameter Illustration	Lengths			Dust Tube	Recoil Cutoff	Controls*	
	Upper	Lower			Extended	Collapsed	Stroke			Rebound	Compression
83613	S16	S16	1-3/8"	A	21.04	12.76	8.28	YES	YES	601	242
83634	ES120	ES120	1-3/8"	A	27.48	16.23	11.25	YES	YES	779	157
83635	ES36	S21	1-3/8"	A	21.74	13.25	8.49	YES	NO	558	119
83636	ES90	ES90	1-3/8"	A	27.72	16.95	10.77	YES	YES	505	148
83901	ES153	ES153	1-3/8"	A	11.15†	9.2†	2.78	YES	YES	509	204
83905	ES86	ES167	1-3/8"	2-1/2" D/T	9.3†	7.81†	2.21	YES	YES	1105	170
83906	ES85	EB1	1-3/8"	2-1/2" D/T	10.45†	8.41†	3.01	YES	YES	586	320
83907	ES147	ES147	1-3/8"	A	14.97	10.61	4.36	YES	YES	460	365
83908	ES27	ES91	1-3/8"	A	9.3	7.03	2.27	YES	NO	904	279
83909	ES20	ES211	1-3/8"	A	9.45	7.33	2.12	YES	YES	646	180
83910	ES169	ES169	1-3/8"	A	11.63†	9.35†	2.28	YES	YES	572	239
83911	ES85	EB1	1-3/8"	A	10.45†	8.41†	2.99	YES	YES	991	321
85000	ES36	ES36	1-5/8"	C	17.28	11.5	5.78	YES	YES	1019	219
85001	EB3	EB3	1-5/8"	C	26.3	16.39	9.92	YES	NO	1202	186
85003	ES90	ES90	1-5/8"	C	25.42	15.63	9.79	YES	YES	437	182
85004	EB3	EB3	1-5/8"	C	20.68	13.67	7.01	YES	YES	1019	219
85005	ES36	ES36	1-5/8"	C	24.76	15.24	9.52	YES	YES	1019	219
85006	ES36	ES36	1-5/8"	C	28.54	17.13	11.41	YES	YES	1019	219
85007	EB3	EB3	1-5/8"	C	24.33	15.4	8.93	YES	YES	1008	171
85009	S21	ES36	1-5/8"	C	23.56	14.4	9.16	YES	YES	857	144
85010	ES36	ES36	1-5/8"	C	26.8	16.26	10.54	YES	YES	1019	219
85011	ES120	ES121	1-5/8"	C	27.49	16.46	11.03	YES	NO	1268	186
85012	EB2	EB2	1-5/8"	C	21.02	13.23	7.79	YES	NO	523	199
85013	ES36	ES36	1-5/8"	C	29.79	17.76	12.04	YES	YES	1019	219
85014	ES36	ES36	1-5/8"	C	21.76	13.74	8.02	YES	YES	1019	219
85023	EB2	EB2	1-5/8"	C	20.27	13	7.27	YES	YES	1008	539
85024	EB2	EB2	1-5/8"	C	28.77	17.25	11.52	YES	YES	1008	539
85025	EB2	S21	1-5/8"	C	23.02	14.01	9.01	YES	NO	1079	539
85026	ES136	S21	1-5/8"	C	23.02	14.01	9.01	YES	NO	1079	539
85027	S21	S21	1-5/8"	C	21.59	13.05	8.54	YES	NO	1008	539
85029	ES36	ES36	1-5/8"	C	20.54	13.11	7.43	YES	YES	1019	219
85030	ES36	ES36	1-5/8"	C	24.05	14.89	9.16	YES	YES	1019	219
85031	ES176	EB2	1-5/8"	C	25.63	15.87	9.76	YES	NO	941	257
85033	S21	EB3	1-5/8"	C	27.26	17.4	9.86	YES	YES	764	254
85036	ES36	ES36	1-5/8"	C	26.38	16.29	10.09	YES	YES	633	119
85040	EB3	EB3	1-5/8"	C	30.91	18.51	12.4	YES	NO	889	114
85042	EB3	EB3	1-5/8"	C	20.64	13.61	7.03	YES	YES	333	161

\* Damping force, in pounds, to either extend or collapse the shock absorber at an average operating velocity. Fuerza de amortiguación en libras para extender o comprimir el amortiguador a una velocidad de operación promedio. La puissance d'amortissement en poids de l'amortisseur, soit comprimé, doit détendu, à une vitesse de fonctionnement moyenne.

† At bumper contact / Al contacto con el tope de goma / Au contact avec le butoir

‡ For GasSLX Series, forces are at the "Firm" (F) setting. / Para la serie GasSLX, las fuerzas están ajustadas en (F) "Firme". / Pour la série GasSLX, le réglage de la force est sur «Firme» (F)

**SPECIFICATIONS BY PART NUMBER**  
**ESPECIFICACIONES POR NÚMERO DE PARTE**  
**SPÉCIFICATIONS PAR NUMÉRO DE PIÈCE**

Gabriel	Mounting		Bore	External Diameter Illustration	Lengths			Dust Tube	Recoil Cutoff	Controls*	
	Upper	Lower			Extended	Collapsed	Stroke			Rebound	Compression
85043	ES36	ES36	1-5/8"	C	27.63	16.85	10.78	YES	YES	628	163
85044	ES36	ES36	1-5/8"	C	22.63	14.1	8.53	YES	NO	722	212
85045	ES36	ES36	1-5/8"	C	14.52	10.12	4.4	YES	YES	1020	219
85046	EB2	EB2	1-5/8"	C	27.55	16.62	10.93	YES	YES	1008	539
85047	EB2	EB2	1-5/8"	C	25.31	15.52	9.79	YES	YES	1008	539
85048	S21	S21	1-5/8"	C	29.16	16.88	12.28	YES	NO	432	106
85049	S21	S21	1-5/8"	C	25.53	15	10.53	YES	NO	597	107
85050	ES36	ES36	1-5/8"	C	23.28	14.5	9.03	YES	NO	525	138
85051	ES36	ES36	1-5/8"	C	18.54	12.13	6.41	YES	YES	1019	139
85052	ES36	ES36	1-5/8"	C	13.26	9.49	3.77	YES	YES	1429	335
85053	EB3	EB3	1-5/8"	C	24.69	15.52	9.17	YES	NO	1019	227
85054	EB2	EB2	1-5/8"	C	23.26	14.37	8.89	YES	NO	602	104
85055	EB2	EB2	1-5/8"	C	25.63	15.63	10	YES	NO	577	102
85056	S21	ES36	1-5/8"	C	20.15	12.87	7.28	YES	YES	732	114
85057	ES36	EB3	1-5/8"	C	21.45	14.23	7.22	YES	YES	1216	115
85058	ES36	ES36	1-5/8"	C	22.67	14.26	8.41	YES	YES	722	114
85059	ES36	EB3	1-5/8"	C	19.09	12.8	6.29	YES	YES	928	151
85060	ES36	ES36	1-5/8"	C	19.79	12.76	7.04	YES	YES	943	405
85061	ES161	ES162	1-5/8"	C	24.76	15.25	9.51	YES	YES	1216	195
85062	EB2	EB2	1-5/8"	C	19.76	12.6	7.16	YES	NO	523	199
85063	EB2	EB2	1-5/8"	C	32.01	18.85	13.16	YES	NO	762	174
85064	ES36	ES36	1-5/8"	C	16.02	10.75	5.27	YES	YES	1481	340
85065	ES161	S21	1-5/8"	C	28.05	17	11.05	YES	YES	1059	300
85066	ES161	ES162	1-5/8"	C	24.64	15.25	9.39	YES	YES	812	322
85067	ES174	ES136	1-5/8"	C	30.54	18.15	12.39	YES	YES	676	170
85069	S21	S21	1-5/8"	C	26.31	15.97	10.33	YES	YES	762	255
85070	ES174	EB3	1-5/8"	C	25.59	15.83	9.76	YES	NO	1100	310
85071	S21	S21	1-5/8"	C	25.57	15.02	10.55	YES	NO	610	107
85072	ES36	ES176	1-5/8"	C	24.17	14.81	9.36	YES	YES	1387	305
85078	ES36	ES36	1-5/8"	C	14.76	10.12	4.64	YES	YES	1409	282
85079	ES36	ES36	1-5/8"	C	12.04	8.87	3.17	YES	YES	1494	325
85080	ES175	S21	1-5/8"	C	22.51	13.77	8.74	YES	NO	447	138
85081	ES175	S21	1-5/8"	C	23.44	14.33	9.11	YES	YES	1658	250
85082	ES90	ES90	1-5/8"	C	28.6	20.64	7.97	YES	YES	1435	266
85083	ES162	S42	1-5/8"	C	27.81	16.53	11.28	YES	YES	1429	184
85084	ES174	ES136	1-5/8"	C	20.59	13.03	7.57	YES	NO	1145	407
85085	S21	S21	1-5/8"	C	24.95	14.67	10.23	YES	NO	970	101
85086	ES36	ES36	1-5/8"	C	17.55	11.63	5.92	YES	YES	2027	389

\* Damping force, in pounds, to either extend or collapse the shock absorber at an average operating velocity. Fuerza de amortiguación en libras para extender o comprimir el amortiguador a una velocidad de operación promedio. La puissance d'amortissement en poids de l'amortisseur, soit comprimé, doit détendu, à une vitesse de fonctionnement moyenne.

† At bumper contact / Al contacto cone el tope de goma / Au contact avec le butoir

‡ For GasSLX Series, forces are at the "Firm" (F) setting. / Para la serie GasSLX, las fuerzas estan ajustada en (F) "Firme". / Pour la série GasSLX, le réglage de la force est sur «Firme» (F)

**SPECIFICATIONS BY PART NUMBER**  
**ESPECIFICACIONES POR NÚMERO DE PARTE**  
**SPÉCIFICATIONS PAR NUMÉRO DE PIÈCE**

Gabriel	Mounting		Bore	External Diameter Illustration	Lengths			Dust Tube	Recoil Cutoff	Controls*	
	Upper	Lower			Extended	Collapsed	Stroke			Rebound	Compression
85087	ES36	ES176	1-5/8"	C	22.78	14.7	8.08	YES	YES	1568	403
85088	ES161	ES162	1-5/8"	C	25.31	15.52	9.79	YES	YES	616	178
85090	ES150	ES36	1-5/8"	C	25.31	15.52	9.79	YES	YES	943	99
85091	ES36	ES36	1-5/8"	C	21.38	13.56	7.82	YES	NO	1121	331
85092	ES150	S21	1-5/8"	C	21.95	15.04	6.89	YES	YES	1597	138
85097	ES36	ES36	1-5/8"	C	27.95	17.11	10.84	YES	YES	1086	109
85099	ES36	ES36	1-5/8"	C	26.02	15.93	10.09	YES	YES	1152	135
85102	ES36	ES136	1-5/8"	C	21.52	14.93	6.59	YES	YES	1224	342
85106	ES150	ES150	1-5/8"	C	20.03	12.89	7.14	YES	YES	1054	109
85109	ES36	ES195	1-5/8"	C	24.21	15.14	9.07	YES	YES	1123	149
85119	ES150	ES150	1-5/8"	C	21.39	13.81	7.68	YES	YES	1387	185
85120	ES175	ES175	1-5/8"	C	23.67	15.06	8.61	YES	NO	2083	519
85122	ES120	S21	1-5/8"	C	22.22	13.78	8.44	YES	YES	926	162
85123	ES120	S21	1-5/8"	C	21.49	13.26	8.23	YES	NO	1809	246
85124	S21	S21	1-5/8"	C	20.91	12.9	8.01	YES	YES	1086	222
85125	ES158	ES159	1-5/8"	C	26.9	16.64	10.26	YES	YES	1479	183
85126	ES158	S21	1-5/8"	C	21.76	13.63	8.13	YES	YES	1086	215
85180	ES150	ES36	1-5/8"	C	20.94	13.83	7.11	YES	YES	681	283
85181	ES150	ES150	1-5/8"	C	26.33	17.06	9.27	YES	YES	681	285
85182	S43	S43	1-5/8"	C	26.86	16.04	10.82	YES	NO	708	232
85188	ES161	ES162	1-5/8"	C	25.31	15.52	9.79	YES	YES	1074	255
85200	ES166	ES182	1-5/8"	C	21.18	13.71	7.48	YES	YES	878	141
85205	ES161	ES162	1-5/8"		22.41	14.69	7.72	YES	YES	518	422
85300	EB3	EB3	1-5/8"	D	17.98	12.21	5.78	YES	YES	1435	676
85301	EB3	EB3	1-5/8"	D	31.92	19.03	12.89	YES	NO	1442	455
85302	EB3	EB3	1-5/8"	D	22.75	14.61	8.14	YES	NO	836	253
85303	EB3	EB3	1-5/8"	D	24.76	15.48	9.29	YES	NO	1019	221
85304	EB3	EB3	1-5/8"	D	22.25	14.22	8.03	YES	NO	767	325
85305	EB3	EB3	1-5/8"	D	27.25	16.7	10.55	YES	NO	1120	225
85307	EB3	EB3	1-5/8"	D	23.98	15.08	8.89	YES	NO	1094	173
85308	EB3	EB3	1-5/8"	D	25.11	15.83	9.28	YES	YES	764	254
85310	S21	S21	1-5/8"	D	18.63	11.71	6.92	YES	YES	1379	578
85311	S21	EB3	1-5/8"	D	23.95	14.79	9.16	YES	YES	764	254
85312	EB3	S21	1-5/8"	D	23.68	14.8	8.88	YES	YES	717	111
85313	EB3	EB3	1-5/8"	D	26.26	16.35	9.91	YES	YES	717	111
85314	EB3	EB3	1-5/8"	D	26.49	16.46	10.03	YES	YES	1216	169
85315	EB3	EB3	1-5/8"	D	29.61	18.07	11.53	YES	NO	380	142

\* Damping force, in pounds, to either extend or collapse the shock absorber at an average operating velocity. Fuerza de amortiguación en libras para extender o comprimir el amortiguador a una velocidad de operación promedio. La puissance d'amortissement en poids de l'amortisseur, soit comprimé, doit détendu, à une vitesse de fonctionnement moyenne.

† At bumper contact / Al contacto con el tope de goma / Au contact avec le butoir

‡ For GasSLX Series, forces are at the "Firm" (F) setting. / Para la serie GasSLX, las fuerzas están ajustadas en (F) "Firme". / Pour la série GasSLX, le réglage de la force est sur «Firme» (F)



**SPECIFICATIONS BY PART NUMBER**  
**ESPECIFICACIONES POR NÚMERO DE PARTE**  
**SPÉCIFICATIONS PAR NUMÉRO DE PIÈCE**

Gabriel	Mounting		Bore	External Diameter Illustration	Lengths			Dust Tube	Recoil Cutoff	Controls*	
	Upper	Lower			Extended	Collapsed	Stroke			Rebound	Compression
85316	S21	ES36	1-5/8"	D	20.61	12.82	7.8	YES	NO	943	443
85317	S21	EB3	1-5/8"	D	27.18	17.42	9.76	YES	YES	764	254
85318	S21	S21	1-5/8"	D	27.37	16.36	11.01	YES	YES	1372	192
85319	S21	ES150	1-5/8"	D	22.22	13.93	8.3	YES	YES	988	454
85320	EB3	EB3	1-5/8"	D	26.15	16.35	9.8	YES	NO	970	308
85321	ES36	ES36	1-5/8"	D	25.38	15.59	9.79	YES	YES	1435	676
85322	EB3	ES160	1-5/8"	D	15.26	11.85	3.41	YES	YES	764	162
85323	ES36	ES36	1-5/8"	D	17.36	11.58	5.78	YES	YES	1085	163
85324	S21	S21	1-5/8"	D	22.14	13.61	8.53	YES	NO	579	114
85325	S21	S21	1-5/8"	D	23.64	14.36	9.28	YES	NO	1024	240
85326	S21	S21	1-5/8"	D	19.64	12.36	7.28	YES	NO	799	142
85327	EB3	ES160	1-5/8"	D	16.01	12.1	3.91	YES	YES	764	162
85328	S21	S21	1-5/8"	D	25.64	15.36	10.28	YES	NO	930	383
85329	EB3	EB3	1-5/8"	D	24.52	15.48	9.04	YES	YES	1550	232
85330	EB3	S21	1-5/8"	D	22.44	14.16	8.28	YES	YES	1140	176
85331	ES158	ES159	1-5/8"	D	19.62	12.85	6.77	YES	YES	1757	396
85332	S42	ES36	1-5/8"	D	20.64	12.98	7.66	YES	YES	2351	967
85333	S42	ES36	1-5/8"	D	20.65	12.98	7.67	YES	YES	1241	534
85334	EB3	EB3	1-5/8"	D	14.52	10.48	4.04	YES	YES	1271	319
85335	ES158	ES159	1-5/8"	D	19.62	12.85	6.77	YES	YES	827	107
85336	S21	S21	1-5/8"	D	18.76	11.86	6.9	YES	NO	861	200
85337	ES36	ES36	1-5/8"	D	28.72	17.44	11.28	YES	YES	1318	374
85338	ES36	ES36	1-5/8"	D	19.47	12.68	6.79	YES	YES	1664	420
85339	EB3	EB3	1-5/8"	D	31.68	19.02	12.66	YES	YES	804	463
85340	ES188	S21	1-5/8"	D	26.46	15.85	10.61	YES	YES	1807	165
85341	ES188	S21	1-5/8"	D	30.96	18.1	12.86	YES	YES	1807	333
85342	S21	S21	1-5/8"	D	23.28	13.99	9.29	YES	NO	893	188
85343	S21	EB3	1-5/8"	D	22.96	14.79	8.17	YES	YES	858	289
85344	ES36	ES36	1-5/8"	D	13.22	9.45	3.77	YES	YES	1581	443
85345	ES36	ES36	1-5/8"	D	21.83	13.82	8.01	YES	YES	1093	219
85346	S21	S21	1-5/8"	D	22.12	13.48	8.64	YES	YES	2016	285
85347	S21	S21	1-5/8"	D	23.62	14.22	9.4	YES	YES	961	122
85351	S21	ES36	1-5/8"	D	20.61	12.82	7.79	YES	NO	1887	259
85376	EB3	EB3	1-5/8"	D	33.27	19.73	13.54	YES	NO	668	134
85377	ES182	ES182	1-5/8"	D	23.8	14.84	8.96	YES	YES	1937	570
85378	ES182	ES182	1-5/8"	D	23.8	14.84	8.96	YES	YES	1110	240
85379	EB3	S21	1-5/8"	D	22.69	14.4	8.29	YES	YES	1658	176

\* Damping force, in pounds, to either extend or collapse the shock absorber at an average operating velocity. Fuerza de amortiguación en libras para extender o comprimir el amortiguador a una velocidad de operación promedio. La puissance d'amortissement en poids de l'amortisseur, soit comprimé, doit détendu, à une vitesse de fonctionnement moyenne.

† At bumper contact / Al contacto con el tope de goma / Au contact avec le butoir

‡ For GasSLX Series, forces are at the "Firm" (F) setting. / Para la serie GasSLX, las fuerzas están ajustadas en (F) "Firme". / Pour la série GasSLX, le réglage de la force est sur «Firme» (F)



**SPECIFICATIONS BY PART NUMBER**  
**ESPECIFICACIONES POR NÚMERO DE PARTE**  
**SPÉCIFICATIONS PAR NUMÉRO DE PIÈCE**

Gabriel	Mounting		Bore	External Diameter Illustration	Lengths			Dust Tube	Recoil Cutoff	Controls*	
	Upper	Lower			Extended	Collapsed	Stroke			Rebound	Compression
85380	EB3	S21	1-5/8"	D	23.95	14.79	9.15	YES	YES	1568	227
85382	ES36	ES36	1-5/8"	D	20.22	13.07	7.15	YES	YES	1658	420
85637	ES90	ES36	1-5/8"	G	20.74	13.19	7.55	YES	NO	2256	327
85638	ES179	ES179	1-5/8"	G	28.58	17.4	11.18	YES	YES	643	138
85639	ES90	ES36	1-5/8"	G	27.08	17.79	9.29	YES	NO	795	109
85642	ES177	ES90	1-5/8"	G	22.52	14.52	8	YES	YES	1920	309
85648	ES90	ES90	1-5/8"	G	22.28	13.97	8.31	YES	NO	761	247
85649	S62	ES34	1-5/8"	G	23.16	16.46	6.7	YES	NO	875	421
85650	ES136	ES34	1-5/8"	G	24.88	16.35	8.53	YES	NO	941	463
85656	ES90	ES90	1-5/8"	G	26.49	16.94	9.55	YES	YES	1225	274
85670	ES175	ES175	1-5/8"	G	23.19	14.67	8.52	YES	YES	591	176
85671	ES175	ES175	1-5/8"	G	21.02	13.8	7.22	YES	NO	3197	315
85672	ES177	ES161	1-5/8"	G	22.44	14.55	7.89	YES	YES	3051	245
85700	EB3	EB3	1-5/8"	D	26.09	16.58	9.51	YES	YES	1446	328
85701	S21	S21	1-5/8"	D	15.64	10.36	5.28	YES	YES	914	204
85702	EB3	EB3	1-5/8"	D	23.76	15.85	7.91	YES	YES	1093	825
85703	S21	EB3	1-5/8"	D	29.57	18.54	11.03	YES	YES	1435	186
85704	EB3	EB3	1-5/8"	D	28.75	18.72	10.03	YES	YES	1435	186
85705	S21	S21	1-5/8"	D	23.62	14.23	9.39	YES	YES	639	436
85706	S21	S21	1-5/8"	D	23.65	14.24	9.41	YES	YES	1086	696
85707	S21	S21	2-1/16"	D	23.65	14.4	9.25	YES	YES	1761	986
85708	S21	S21	1-5/8"	D	20.63	12.85	7.78	YES	YES	914	204
85709	S21	S21	1-5/8"	D	31.64	18.36	13.28	YES	YES	700	203
85710	S21	EB3	1-5/8"	D	23.45	15.1	8.34	YES	YES	994	248
85711	S21	EB3	1-5/8"	D	24.54	15.26	9.27	YES	YES	1435	208
85712	EB3	EB3	1-5/8"	D	20.5	13.47	7.04	YES	YES	1435	562
85713	EB3	EB3	1-5/8"	D	24.51	15.48	9.04	YES	YES	1157	180
85714	EB3	EB3	1-5/8"	D	25.13	15.85	9.28	YES	YES	1220	175
85715	EB3	EB3	1-5/8"	D	25.13	15.85	9.28	YES	YES	1915	200
85716	EB3	EB3	1-5/8"	D	21.99	14.33	7.66	YES	YES	1220	175
85717	EB3	EB3	1-5/8"	D	25.13	15.85	9.28	YES	YES	1915	200
85718	EB3	EB3	1-5/8"	D	22.13	15.04	7.09	YES	YES	2506	206
85719	EB3	EB3	1-5/8"	D	17.25	11.97	5.28	YES	YES	1517	213
85720	EB3	EB3	1-5/8"	D	20.5	13.47	7.03	YES	YES	1435	562
85722	S21	S21	1-5/8"	D	27.16	16.41	10.76	YES	YES	1264	369
85723	EB3	S21	1-5/8"	D	19.93	12.9	7.03	YES	YES	1318	248
85724	ES158	ES159	1-5/8"	D	22.81	14.51	8.3	YES	YES	1235	454

\* Damping force, in pounds, to either extend or collapse the shock absorber at an average operating velocity. Fuerza de amortiguación en libras para extender o comprimir el amortiguador a una velocidad de operación promedio. La puissance d'amortissement en poids de l'amortisseur, soit comprimé, doit détendu, à une vitesse de fonctionnement moyenne.

† At bumper contact / Al contacto con el tope de goma / Au contact avec le butoir

‡ For GasSLX Series, forces are at the "Firm" (F) setting. / Para la serie GasSLX, las fuerzas están ajustadas en (F) "Firme". / Pour la série GasSLX, le réglage de la force est sur «Firme» (F)

**SPECIFICATIONS BY PART NUMBER  
ESPECIFICACIONES POR NÚMERO DE PARTE  
SPÉCIFICATIONS PAR NUMÉRO DE PIÈCE**

Gabriel	Mounting		Bore	External Diameter Illustration	Lengths			Dust Tube	Recoil Cutoff	Controls*	
	Upper	Lower			Extended	Collapsed	Stroke			Rebound	Compression
85727	S21	S21	1-5/8"	D	29.88	17.34	12.54	YES	YES	783	111
85728	S21	S21	1-5/8"	D	24.37	14.86	9.51	YES	YES	1435	510
85729	EB3	S21	1-5/8"	D	21.55	13.77	7.78	YES	YES	783	111
85730	EB3	EB3	1-5/8"	D	30.75	18.72	12.03	YES	YES	1517	293
85731	S21	EB3	1-5/8"	D	30.57	18.54	12.03	YES	YES	1517	293
85732	EB3	EB3	2-1/16"	E	22.13	15.11	7.03	YES	YES	2632	382
85733	EB3	S21	1-5/8"	D	23.57	14.73	8.84	YES	YES	717	111
85734	EB3	EB3	1-5/8"	D	20.73	13.7	7.03	YES	YES	1288	227
85735	EB3	EB3	1-5/8"	D	26.72	16.7	10.02	YES	YES	1288	227
85736	EB3	EB3	1-5/8"	D	23.61	15.2	8.41	YES	YES	1155	352
85737	ES173	ES173	1-5/8"	D	15.11	10.84	4.27	YES	YES	3066	782
85738	ES36	ES36	1-5/8"	D	17.46	11.69	5.77	YES	YES	1830	416
85739	ES187	ES187	1-5/8"	D	20.73	13.54	7.19	YES	YES	3247	334
85740	EB3	S21	1-5/8"	D	24.7	15.15	9.55	YES	YES	848	305
85745	S21	S21	1-5/8"	D	19.88	12.34	7.54	YES	YES	3064	231
85746	S21	S21	1-5/8"	D	19.88	12.34	7.54	YES	YES	1754	167
85900	S21	S21	1-5/8"	G	17.33	11.23	6.11	YES	YES	1467	337
85901	EB3	EB3	1-5/8"	G	29.09	17.68	11.42	YES	NO	1830	418
85902	S21	S21	1-5/8"	G	19.03	12.09	6.93	YES	YES	1441	267
85903	ES36	ES36	1-5/8"	G	31.99	19.13	12.86	YES	YES	666	113
85904	ES36	ES36	1-5/8"	G	27.61	16.88	10.73	YES	YES	666	113
85905	ES36	EB3	1-5/8"	G	23.81	16.16	7.66	YES	YES	1020	219
85906	ES36	ES36	1-5/8"	G	21.77	14.05	7.72	YES	YES	700	255
85907	ES36	EB3	1-5/8"	G	21.43	14.2	7.23	YES	YES	1216	251
85908	ES36	ES36	1-5/8"	G	18.48	12.25	6.23	YES	YES	1020	219
85909	ES36	ES36	1-5/8"	G	24.25	15.19	9.06	YES	YES	700	255
85910	ES36	ES36	1-5/8"	G	20.79	13.54	7.25	YES	YES	1074	219
85911	ES36	ES36	1-5/8"	G	16.89	11.53	5.36	YES	YES	1020	219
85912	EB3	ES36	1-5/8"	G	18.68	12.57	6.11	YES	YES	1020	219
85913	ES36	EB3	1-5/8"	G	22.56	15.2	7.36	YES	YES	1020	219
85914	ES36	ES36	1-5/8"	G	14.36	10.25	4.11	YES	YES	1020	219
85915	ES36	EB3	1-5/8"	G	19.06	12.7	6.36	YES	YES	1020	219
85916	ES36	ES36	1-5/8"	G	24.65	15.55	9.1	YES	YES	1149	219
85918	ES150	ES150	1-5/8"	G	22.97	14.58	8.39	YES	NO	1726	412
85919	ES36	ES36	1-5/8"	G	22.52	14.33	8.19	YES	YES	1265	121
85920	ES150	ES150	1-5/8"	G	21.16	13.57	7.59	YES	NO	845	49
85921	S21	ES36	1-5/8"	G	22.07	13.57	8.5	YES	NO	2053	339

\* Damping force, in pounds, to either extend or collapse the shock absorber at an average operating velocity. Fuerza de amortiguación en libras para extender o comprimir el amortiguador a una velocidad de operación promedio. La puissance d'amortissement en poids de l'amortisseur, soit comprimé, doit détendu, à une vitesse de fonctionnement moyenne.

† At bumper contact / Al contacto con el tope de goma / Au contact avec le butoir

‡ For GasSLX Series, forces are at the "Firm" (F) setting. / Para la serie GasSLX, las fuerzas están ajustadas en (F) "Firme". / Pour la série GasSLX, le réglage de la force est sur «Firme» (F)

**SPECIFICATIONS BY PART NUMBER  
ESPECIFICACIONES POR NÚMERO DE PARTE  
SPÉCIFICATIONS PAR NUMÉRO DE PIÈCE**

Gabriel	Mounting		Bore	External Diameter Illustration	Lengths			Dust Tube	Recoil Cutoff	Controls*	
	Upper	Lower			Extended	Collapsed	Stroke			Rebound	Compression
85922	ES150	ES150	1-5/8"	G	21.19	13.53	7.66	YES	NO	878	185
85923	ES177	ES161	1-5/8"	G	22.52	14.52	8	YES	YES	1940	221
85924	ES90	ES36	1-5/8"	G	20.39	12.99	7.41	YES	NO	1036	122
85925	ES90	ES90	1-5/8"	G	22.56	15.6	6.95	YES	NO	761	144
85926	ES90	ES90	1-5/8"	G	26.5	17.96	8.54	YES	YES	1387	279
85927	ES90	ES90	1-5/8"	G	24.76	15.47	9.3	YES	YES	1288	388
85928	ES90	ES90	1-5/8"	G	20.31	13.24	7.07	YES	NO	957	229
85929	ES90	ES90	1-5/8"	G	20.28	13.21	7.08	YES	NO	2214	267
85930	ES177	ES161	1-5/8"	G	17.86	12	5.86	YES	YES	1617	342
85931	ES177	ES161	1-5/8"	G	22.52	14.52	8	YES	YES	1435	220
85932	ES178	ES150	1-5/8"	G	21.26	13.7	7.56	YES	YES	1102	430
85933	ES175	ES175	1-5/8"	G	18.27	12.72	5.54	YES	YES	1089	383
85934	ES36	ES36	1-5/8"	G	17.8	12.04	5.75	YES	YES	3511	1063
85935	S21	ES36	1-5/8"	G	18.7	11.92	6.78	YES	NO	1054	419
85936	ES174	S43	1-5/8"	G	17.27	11.48	5.79	YES	YES	1479	337
85937	ES174	S43	1-5/8"	G	19.04	12.35	6.7	YES	YES	1479	337
85938	ES36	ES36	1-5/8"	G	16.06	10.82	5.24	YES	YES	1581	432
85939	ES36	ES36	1-5/8"	G	14.44	10.04	4.41	YES	YES	1719	420
85953	ES90	ES90	1-5/8"	G	26.13	15.86	10.27	YES	NO	2001	153
85954	ES90	ES36	1-5/8"	G	20.43	13	7.43	YES	NO	1812	148
85955	ES175	ES150	1-5/8"	G	21.25	13.66	7.59	YES	YES	1034	397
85956	ES183	ES184	1-5/8"	G	30.65	18.77	11.88	YES	YES	979	373
85957	ES90	ES90	1-5/8"	G	20.78	13.19	7.6	YES	NO	1583	138
85958	ES150	ES150	1-5/8"	G	22.89	14.5	8.39	YES	YES	1926	281
85959	ES150	ES150	1-5/8"	G	21.16	13.57	7.59	YES	YES	1021	123
85961	ES178	ES176	1-5/8"	G	22.83	14.17	8.66	YES	YES	2206	240
85962	ES178	ES176	1-5/8"	G	21.8	13.66	8.15	YES	YES	2206	240
85963	ES90	ES36	1-5/8"	G	25.49	18.68	6.81	YES	YES	1490	206
85964	ES90	ES36	1-5/8"	G	25.49	18.68	6.81	YES	YES	1981	205
85965	ES178	ES161	1-5/8"	G	24.24	15.15	9.09	YES	YES	2206	238
85966	ES178	ES161	1-5/8"	G	23.25	14.64	8.62	YES	YES	2206	238
85967	ES178	ES176	1-5/8"	G	23.93	14.86	9.07	YES	YES	2206	238
85968	EB3	EB3	1-5/8"	G	19.87	13.39	6.48	YES	YES	1069	227
85969	ES90	ES36	1-5/8"	G	18.38	11.93	6.45	YES	NO	1612	125
85970	ES188	S21	1-5/8"	G	27.23	16.44	10.79	YES	YES	1092	147
85971	ES36	ES36	1-5/8"	G	22.56	14.17	8.39	YES	NO	2315	451
85972	ES36	ES36	1-5/8"	G	30.78	18.26	12.52	YES	NO	1493	261

\* Damping force, in pounds, to either extend or collapse the shock absorber at an average operating velocity. Fuerza de amortiguación en libras para extender o comprimir el amortiguador a una velocidad de operación promedio. La puissance d'amortissement en poids de l'amortisseur, soit comprimé, doit détendu, à une vitesse de fonctionnement moyenne.

† At bumper contact / Al contacto cone el tope de goma / Au contact avec le butoir

‡ For GasSLX Series, forces are at the "Firm" (F) setting. / Para la serie GasSLX, las fuerzas estan ajustada en (F) "Firme". / Pour la série GasSLX, le réglage de la force est sur «Firme» (F)

**SPECIFICATIONS BY PART NUMBER**  
**ESPECIFICACIONES POR NÚMERO DE PARTE**  
**SPÉCIFICATIONS PAR NUMÉRO DE PIÈCE**

Gabriel	Mounting		Bore	External Diameter Illustration	Lengths			Dust Tube	Recoil Cutoff	Controls*	
	Upper	Lower			Extended	Collapsed	Stroke			Rebound	Compression
85974	ES36	ES36	1-5/8"	G	26.02	16.11	9.91	YES	YES	3087	230
85975	ES36	ES36	1-5/8"	G	24.24	15.15	9.09	YES	YES	1658	219
85976	ES36	ES36	1-5/8"	G	29.92	18.12	11.8	YES	YES	582	138
85977	ES36	S42	1-5/8"	G	26.2	15.91	10.29	YES	YES	582	138
85978	ES179	ES179	1-5/8"	G	29.84	18.16	11.69	YES	YES	582	138
85979	ES36	ES36	1-5/8"	G	31.18	18.66	12.52	YES	YES	582	138
85980	ES179	ES179	1-5/8"	G	31.17	18.66	12.52	YES	YES	582	138
85984	ES158	ES150	1-5/8"	G	25.44	15.96	9.48	YES	YES	2248	1168
85985	ES174	S43	1-5/8"	G	19.04	12.31	6.73	YES	YES	2068	723
85986	ES175	ES150	1-5/8"	G	21.25	13.66	7.59	YES	YES	1754	221
85988	S21	EB3	1-5/8"	G	23.84	14.87	8.97	YES	YES	1200	138
85989	ES174	ES136	1-5/8"	G	20.78	13.15	7.63	YES	NO	1812	351
85994	ES90	ES36	1-5/8"	G	21.21	13.4	7.81	YES	NO	1824	263
85995	ES90	ES36	1-5/8"	G	23.5	14.52	8.98	YES	NO	1830	173
85998	ES90	ES90	1-5/8"	G	22.83	14.17	8.66	YES	NO	1345	178
85999	ES90	ES90	1-5/8"	G	19.84	12.79	7.05	YES	NO	2214	259
86200	ES194	ES194	45 MM	D	14.24	10.45	3.79	YES	YES	4238	688
86201	ES193	ES193	45 MM	D	13.26	9.94	3.32	YES	YES	4238	688
86202	ES193	ES193	45 MM	D	14.52	10.43	4.09	YES	YES	4238	688
86203	ES193	ES193	45 MM	D	16.88	11.61	5.27	YES	YES	4238	910
87000	S21	EB3	2-1/16"	E	24.46	15.21	9.25	YES	YES	1332	300
87001	EB3	EB3	2-1/16"	E	20.76	13.76	7	YES	YES	1158	190
87002	EB3	EB3	2-1/16"	E	23.5	15.41	8.09	YES	YES	879	203
87003	EB3	EB3	2-1/16"	E	26.26	16.51	9.75	YES	YES	1332	395
87004	EB3	EB3	2-1/16"	E	26.76	16.76	10	YES	YES	1158	190
87006	EB3	EB3	2-1/16"	E	23.75	15.25	8.5	YES	YES	1158	272
87007	S21	S21	2-1/16"	E	15.65	10.4	5.25	YES	YES	879	253
87011	S21	S21	2-1/16"	E	23.65	14.4	9.25	YES	YES	1750	1050
87012	S21	S21	2-1/16"	E	23.65	14.4	9.25	YES	YES	650	364
87013	S21	S21	2-1/16"	E	23.65	14.4	9.25	YES	YES	1075	585
87015	ES173	ES173	45MM	E	15.51	11.18	4.33	YES	YES	4950	900
87016	S21	EB3	2-1/16"	E	21.17	13.91	7.26	YES	YES	1808	238
87017	ES160	ES160	2-1/16"	E	23.35	15.31	8.07	YES	YES	1876	220
87018	ES36	ES36	2-1/16"	E	17.36	11.71	5.65	YES	YES	2479	1000
87019	ES160	ES160	2-1/16"	E	24.84	15.85	8.9	YES	YES	2972	665
89401	EB2	EB2	1-5/8"	G	28.41	17.16	11.25	YES	NO	665†	194
89402	EB2	EB2	1-5/8"	G	24.41	15.16	9.25	YES	NO	874‡	206

\* Damping force, in pounds, to either extend or collapse the shock absorber at an average operating velocity. Fuerza de amortiguación en libras para extender o comprimir el amortiguador a una velocidad de operación promedio. La puissance d'amortissement en poids de l'amortisseur, soit comprimé, doit détendu, à une vitesse de fonctionnement moyenne.

† At bumper contact / Al contacto con el tope de goma / Au contact avec le butoir

‡ For GasSLX Series, forces are at the "Firm" (F) setting. / Para la serie GasSLX, las fuerzas están ajustadas en (F) "Firme". / Pour la série GasSLX, le réglage de la force est sur «Firme» (F)

**SPECIFICATIONS BY PART NUMBER  
ESPECIFICACIONES POR NÚMERO DE PARTE  
SPÉCIFICATIONS PAR NUMÉRO DE PIÈCE**

Gabriel	Mounting		Bore	External Diameter Illustration	Lengths			Dust Tube	Recoil Cutoff	Controls*	
	Upper	Lower			Extended	Collapsed	Stroke			Rebound	Compression
89403	EB2	EB2	1-5/8"	G	26.86	17.16	9.7	YES	YES	929‡	281
89405	ES36	ES36	1-5/8"	G	26.3	16.57	9.73	YES	YES	1009‡	249
89406	ES36	ES36	1-5/8"	G	24.76	15.82	8.93	YES	YES	658‡	125
89407	ES36	ES36	1-5/8"	G	21.61	14.17	7.45	YES	YES	652‡	218
89408	EB2	EB2	1-5/8"	G	19.68	12.9	6.78	YES	NO	536‡	201
89409	EB2	EB2	1-5/8"	G	27.13	16.92	10.2	YES	YES	567‡	165
89410	EB3	EB3	1-5/8"	G	26.34	16.57	9.77	YES	NO	1185‡	182
89411	ES90	ES90	1-5/8"	G	25.39	16.06	9.34	YES	YES	436‡	186
89412	EB3	EB3	1-5/8"	G	24.26	15.68	8.58	YES	YES	1155‡	169
89413	EB2	EB2	1-5/8"	G	20.94	13.53	7.41	YES	NO	536‡	201
89414	ES36	ES36	1-5/8"	G	29.65	18.18	11.46	YES	YES	1045‡	217
89415	EB2	EB2	1-5/8"	G	20.12	13.29	6.83	YES	YES	1155‡	514
89416	EB2	EB2	1-5/8"	G	28.62	17.54	11.08	YES	YES	1155‡	514
89417	ES136	S21	1-5/8"	G	22.94	14.31	8.63	YES	NO	1226‡	515
89418	S21	S21	1-5/8"	G	21.44	13.19	8.25	YES	NO	1266‡	515
89419	EB3	EB3	1-5/8"	G	18.04	12.67	5.36	YES	YES	1352‡	636
89420	EB3	EB3	1-5/8"	G	22.8	14.8	8	YES	NO	862‡	258
89422	EB3	EB3	1-5/8"	G	25.12	16.3	8.83	YES	YES	794‡	253
89423	S21	S21	1-5/8"	G	18.67	12.21	6.46	YES	YES	1352‡	573
89424	S21	EB3	1-5/8"	G	23.73	15.14	8.59	YES	YES	794‡	253
89425	EB3	EB3	1-5/8"	G	26.5	16.93	9.57	YES	YES	1352‡	167
89426	S21	ES36	1-5/8"	G	20.46	13.05	7.41	YES	NO	926‡	419
89427	S21	EB3	1-5/8"	G	27.19	17.62	9.57	YES	YES	794‡	253
89428	S21	ES150	1-5/8"	G	22	14.27	7.72	YES	YES	958‡	446
89429	EB3	EB3	1-5/8"	G	26.22	16.57	9.65	YES	NO	941‡	266
89430	ES36	ES36	1-5/8"	G	24.61	15.66	8.94	YES	YES	1462‡	279
89431	ES36	ES36	1-5/8"	G	22.41	14.16	8.25	YES	NO	751‡	211
89432	ES36	ES36	1-5/8"	G	23.42	14.79	8.63	YES	NO	1507‡	561
89434	EB2	EB2	1-5/8"	G	27.12	16.79	10.33	YES	YES	1155‡	514
89435	EB2	EB2	1-5/8"	G	24.92	15.82	9.1	YES	YES	1155‡	514
89436	ES36	ES36	1-5/8"	G	17.24	12.04	5.2	YES	YES	998‡	217
89437	ES36	ES36	1-5/8"	G	20.12	13.42	6.7	YES	YES	1155‡	514
89438	EB2	EB2	1-5/8"	G	23.17	14.54	8.63	YES	NO	583‡	103
89439	EB2	EB2	1-5/8"	G	25.67	15.79	9.88	YES	NO	518‡	103
89440	ES36	ES36	1-5/8"	G	23.9	15.31	8.59	YES	YES	1498‡	561
89441	S21	ES36	1-5/8"	G	20.14	13.06	7.08	YES	YES	761‡	126
89442	EB3	EB3	1-5/8"	G	24.72	15.74	8.98	YES	NO	1055‡	224

\* Damping force, in pounds, to either extend or collapse the shock absorber at an average operating velocity. Fuerza de amortiguación en libras para extender o comprimir el amortiguador a una velocidad de operación promedio. La puissance d'amortissement en poids de l'amortisseur, soit comprimé, doit détendu, à une vitesse de fonctionnement moyenne.

† At bumper contact / Al contacto con el tope de goma / Au contact avec le butoir

‡ For GasSLX Series, forces are at the "Firm" (F) setting. / Para la serie GasSLX, las fuerzas están ajustadas en (F) "Firme". / Pour la série GasSLX, le réglage de la force est sur «Firme» (F)

**SPECIFICATIONS BY PART NUMBER**  
**ESPECIFICACIONES POR NÚMERO DE PARTE**  
**SPÉCIFICATIONS PAR NUMÉRO DE PIÈCE**

Gabriel	Mounting		Bore	External Diameter Illustration	Lengths			Dust Tube	Recoil Cutoff	Controls*	
	Upper	Lower			Extended	Collapsed	Stroke			Rebound	Compression
89443	ES158	ES159	1-5/8"	G	22.19	14.66	7.53	YES	YES	1206‡	466
89446	EB2	EB2	1-5/8"	G	28.36	17.41	10.95	YES	YES	702‡	204
89447	S21	S21	1-5/8"	G	23.63	14.69	8.94	YES	YES	702‡	241
89448	ES161	ES162	1-5/8"	G	24.61	15.66	8.94	YES	YES	782‡	323
89449	ES150	ES150	1-5/8"	G	23.25	14.9	8.35	YES	NO	1519‡	324
89450	ES161	ES162	1-5/8"	G	24.61	15.66	8.94	YES	YES	1282‡	193
89451	ES174	ES136	1-5/8"	G	30.39	18.54	11.86	YES	YES	645‡	172
89453	ES178	ES150	1-5/8"	G	21.14	13.93	7.21	YES	YES	860‡	435
89454	ES175	ES175	1-5/8"	G	18.27	12.91	5.36	YES	YES	938‡	388
89455	S21	S21	1-5/8"	G	26.31	16.03	10.28	YES	YES	791‡	276
89456	ES174	S43	1-5/8"	G	17.04	11.63	5.4	YES	YES	975‡	377
89457	ES90	ES36	1-5/8"	G	19.92	13.02	6.89	YES	NO	941‡	156
89458	ES177	ES161	1-5/8"	G	22.48	14.6	7.88	YES	YES	1575‡	222
89459	ES174	EB3	1-5/8"	G	25.63	16.14	9.49	YES	NO	1179‡	314
89460	ES174	ES136	1-5/8"	G	20.58	13.03	7.55	YES	NO	997‡	384
89461	ES160	ES160	1-5/8"	G	19.96	13.58	6.38	YES	YES	897‡	103
89503	ES150	ES150	1-5/8"	G	21.28	13.72	7.56	YES	NO	1033‡	123

\* Damping force, in pounds, to either extend or collapse the shock absorber at an average operating velocity. Fuerza de amortiguación en libras para extender o comprimir el amortiguador a una velocidad de operación promedio. La puissance d'amortissement en poids de l'amortisseur, soit comprimé, doit détendu, à une vitesse de fonctionnement moyenne.

† At bumper contact / Al contacto con el tope de goma / Au contact avec le butoir

‡ For GasSLX Series, forces are at the "Firm" (F) setting. / Para la serie GasSLX, las fuerzas están ajustadas en (F) "Firme". / Pour la série GasSLX, le réglage de la force est sur «Firme» (F)

**MOUNTING ACCESSORY PACKAGES AND COMPONENT PARTS**  
**KITS DE ACCESORIOS Y COMPONENTES**  
**ENSEMBLES D'ACCESSOIRES DE MONTURES ET DE PIÈCES DÉTACHÉES**

<b>140126</b>	401006	1	Hex nut / Tuerca hexagonal / Écrou hexagonal	3/8" x 24 UNF thread
	401383	2	Retainer (washer) / Seguro (arandela) / Arrêt (rondelle)	3/8 in. I.D. x 1-1/2 in. O.D. x .093 in. thick
	402263	2	Bushing / Buje / Bague	7/8" centering lip for 3/8" O.D. stud
<b>140149</b>	401011	4	Bushing / Buje / Bague	EB2 style - for 1-3/4" O.D. eye ring - 3/4" diam. Stud
<b>140169</b>	401011	2	Bushing / Buje / Bague	EB2 style - for 1-3/4" O.D. eye ring - 3/4" diam. Stud
<b>140357</b>	401164	1	Hex nut / Tuerca hexagonal / Écrou hexagonal	1/2" x 20 UNF Thread
	401166	1	Lock washer / Arandela de seguridad / Rondelle-frein	1/2" lock washer
	401174	1	Hex nut / Tuerca hexagonal / Écrou hexagonal	5/8" x 18 thread
	401193	1	Lock washer / Arandela de seguridad / Rondelle-frein	5/8" I.D. (thin)
	401266	1	Retainer (washer) / Seguro (arandela) / Arrêt (rondelle)	5/8" I.D. x 1-1/4" O.D. x .075" thick
	402519	1	Retainer (washer) / Seguro (arandela) / Arrêt (rondelle)	1/2" I.D. x 1-1/4" O.D. x .104" thick
	403050	1	Stud / Perno / Goujon	1/2" x 20 and 5/8" x 18 thread
<b>140455</b>	401006	1	Hex nut / Tuerca hexagonal / Écrou hexagonal	3/8" x 24 UNF thread
	401008	2	Retainer (washer) / Seguro (arandela) / Arrêt (rondelle)	3/8 in. I.D. x 1-1/4 in. O.D. x .075 in. thick
	403489	2	Bushing / Buje / Bague	5/8" centering lip for 3/8" O.D. stud
<b>140524</b>	401006	1	Hex nut / Tuerca hexagonal / Écrou hexagonal	3/8" x 24 UNF thread
	401376	2	Retainer (washer) / Seguro (arandela) / Arrêt (rondelle)	3/8 in. I.D. x 1-3/8 in. O.D. x .089 in. thick
	402294	2	Bushing / Buje / Bague	5/8" lip for 3/8" dia. stud-5/8" or 7/8" holes
<b>140526</b>	403813	2	Boot / Bota / Gaine	
	403815	2	Cotter pin / Chaveta / Goupille	
	404046	2	Nut / Tuerca / Écrou	1/2" x 20 UNF Thread
<b>140673</b>	401006	1	Hex nut / Tuerca hexagonal / Écrou hexagonal	3/8" x 24 UNF thread
	401008	2	Retainer (washer) / Seguro (arandela) / Arrêt (rondelle)	3/8 in. I.D. x 1-1/4 in. O.D. x .075 in. thick
	403962	2	Bushing / Buje / Bague	1/2" centering lip for 3/8" O.D. stud
<b>140689</b>	401006	3	Hex nut / Tuerca hexagonal / Écrou hexagonal	3/8" x 24 UNF thread
	402263	2	Bushing / Buje / Bague	7/8" centering lip for 3/8" O.D. stud
	404001	2	Retainer (washer) / Seguro (arandela) / Arrêt (rondelle)	10 mm I.D. x 1-1/2" O.D. x .120" thick
<b>140702</b>	401174	1	Hex nut / Tuerca hexagonal / Écrou hexagonal	5/8" x 18 thread
	401184	1	Lock washer / Arandela de seguridad / Rondelle-frein	7/16" Lock washer
	401193	1	Lock washer / Arandela de seguridad / Rondelle-frein	5/8" I.D. (thin)
	402844	1	Hex nut / Tuerca hexagonal / Écrou hexagonal	7/16" x 20 UNF Thread
	403878	1	Washer / Arandela / Rondelle	0.453" I.D. x 1.25" O.D. x .075" thick
	404782	1	Stud / Perno / Goujon	5/8" x 18 and 7/16" x 20
<b>140719</b>	402653-001	2	Lock washer / Arandela de seguridad / Rondelle-frein	5/16" I.D. (med.)
	403870-001	2	Bolt / Tornillo / Boulon	Hex Head 5/16" x 18 x 3/4 in. long
	403871-001	2	Hex nut / Tuerca hexagonal / Écrou hexagonal	5/16" x 18 thread
<b>140780</b>	401006	1	Hex nut / Tuerca hexagonal / Écrou hexagonal	3/8" x 24 UNF thread
	402943	1	Retainer (washer) / Seguro (arandela) / Arrêt (rondelle)	0.457" I.D. x 1.68" O.D. x .120" thick
	403298	1	Retainer (washer) / Seguro (arandela) / Arrêt (rondelle)	0.390" I.D. x 1.68" O.D. x .120" thick
	403299	2	Bushing / Buje / Bague	7/8" centering lip for 7/16" O.D. stud
<b>140857</b>	401006	1	Hex nut / Tuerca hexagonal / Écrou hexagonal	3/8" x 24 UNF thread
	401008	1	Retainer (washer) / Seguro (arandela) / Arrêt (rondelle)	3/8 in. I.D. x 1-1/4 in. O.D. x .075 in. thick
	401383	1	Retainer (washer) / Seguro (arandela) / Arrêt (rondelle)	3/8 in. I.D. x 1-1/2 in. O.D. x .093 in. thick
	403489	2	Bushing / Buje / Bague	5/8" centering lip for 3/8" O.D. stud
	429680-030	1	Instruction sheet / Hoja de instr. / Feuillet d'instr.	
<b>140884</b>	401267	1	Retainer (washer) / Seguro (arandela) / Arrêt (rondelle)	5/8" I.D. x 1-1/4" O.D. x .075" thick
	402662	1	Spacer / Espaciador / Entretoise	5/8" I.D. x 1-1/4" O.D. x 1/4" thick
	412016	1	Extn nut / Tuerca ext. / Écrou ext.	7/16" x 20 UNF Thread
	427030	1	Instruction sheet / Hoja de instr. / Feuillet d'instr.	



**MOUNTING ACCESSORY PACKAGES AND COMPONENT PARTS**  
**KITS DE ACCESORIOS Y COMPONENTES**  
**ENSEMBLES D'ACCESSOIRES DE MONTURES ET DE PIÈCES DÉTACHÉES**

<b>140885</b>	401267	1	Retainer (washer) / Seguro (arandela) / Arrêt (rondelle)	5/8" I.D. x 1-1/4" O.D. x .075" thick
	402662	1	Spacer / Espaciador / Entretoise	5/8" I.D. x 1-1/4" O.D. x 1/4" thick
	403189	2	Spacer / Espaciador / Entretoise	1/2" I.D. x 1-1/4" O.D.
	411012	2	Sleeve / Camisa / Manchon	13 mm I.D. x 5/8 in. O.D. x 1-5/16 in. long
	412016	1	Extn nut / Tuerca ext. / Écrou ext.	7/16" x 20 UNF Thread
	427031	1	Instruction sheet / Hoja de instr. / Feuillet d'instr.	
<b>140921</b>	401006	1	Hex nut / Tuerca hexagonal / Écrou hexagonal	3/8" x 24 UNF thread
	401007	1	Pal nut / Tuerca de cierre / Écrou Pal	3/8" x 24 UNF thread
	401011	2	Bushing / Buje / Bague	EB2 style - for 1-3/4" O.D. eye ring - 3/4" diam. Stud
	401377	1	Retainer (washer) / Seguro (arandela) / Arrêt (rondelle)	1/2" I.D. x 1-3/8" O.D. x .075" thick
	401383	1	Retainer (washer) / Seguro (arandela) / Arrêt (rondelle)	3/8 in. I.D. x 1-1/2 in. O.D. x .093 in. thick
	402267	2	Bushing / Buje / Bague	9/16" centering lip for 7/16" O.D. stud
<b>140947</b>	401193	1	Lock washer / Arandela de seguridad / Rondelle-frein	5/8" I.D. (thin)
	404451	2	Hex nut / Tuerca hexagonal / Écrou hexagonal	16 x 1.5 metric thread
	404452	4	Retainer (washer) / Seguro (arandela) / Arrêt (rondelle)	5/8" I.D. x 2-3/4" O.D. x .180" thick
	404453	2	Sleeve / Camisa / Manchon	16 mm I.D. x 1-3/16" O.D. x 1-1/2" long
	404454	4	Bushing / Buje / Bague	1-3/16" centering lip for 13/16" O.D. stud
<b>141041</b>	401006	1	Hex nut / Tuerca hexagonal / Écrou hexagonal	3/8" x 24 UNF thread
	401376	2	Retainer (washer) / Seguro (arandela) / Arrêt (rondelle)	3/8 in. I.D. x 1-3/8 in. O.D. x .089 in. thick
	404652	2	Bushing / Buje / Bague	Used with 5/8" dia. hole or 7/8" dia. Hole
<b>141045</b>	401006	1	Hex nut / Tuerca hexagonal / Écrou hexagonal	3/8" x 24 UNF thread
	401377	1	Retainer (washer) / Seguro (arandela) / Arrêt (rondelle)	1/2" I.D. x 1-3/8" O.D. x .075" thick
	401383	1	Retainer (washer) / Seguro (arandela) / Arrêt (rondelle)	3/8 in. I.D. x 1-1/2 in. O.D. x .093 in. thick
	402284	2	Bushing / Buje / Bague	5/8" centering lip for 3/8" O.D. stud
<b>141047</b>	401006	1	Hex nut / Tuerca hexagonal / Écrou hexagonal	3/8" x 24 UNF thread
	401164	1	Hex nut / Tuerca hexagonal / Écrou hexagonal	1/2" x 20 UNF Thread
	401166	1	Lock washer / Arandela de seguridad / Rondelle-frein	1/2" lock washer
	401184	1	Lock washer / Arandela de seguridad / Rondelle-frein	7/16" Lock washer
	402844	1	Hex nut / Tuerca hexagonal / Écrou hexagonal	7/16" x 20 UNF Thread
	402943	1	Retainer (washer) / Seguro (arandela) / Arrêt (rondelle)	0.457" I.D. x 1.68" O.D. x .120" thick
	403298	1	Retainer (washer) / Seguro (arandela) / Arrêt (rondelle)	0.390" I.D. x 1.68" O.D. x .120" thick
	403299	2	Bushing / Buje / Bague	7/8" centering lip for 7/16" O.D. stud
	403877	1	Stud / Perno / Goujon	1/2" x 20 and 7/16" x 20
	403878	1	Washer / Arandela / Rondelle	0.453" I.D. x 1.25" O.D. x .075" thick
<b>141083</b>	401193	1	Lock washer / Arandela de seguridad / Rondelle-frein	5/8" I.D. (thin)
	404451	1	Hex nut / Tuerca hexagonal / Écrou hexagonal	16 x 1.5 metric thread
	404452	2	Retainer (washer) / Seguro (arandela) / Arrêt (rondelle)	5/8" I.D. x 2-3/4" O.D. x .180" thick
	404453	1	Sleeve / Camisa / Manchon	16 mm I.D. x 1-3/16" O.D. x 1-1/2" long
	404454	2	Bushing / Buje / Bague	1-3/16" centering lip for 13/16" O.D. stud
<b>141108</b>	401174	2	Hex nut / Tuerca hexagonal / Écrou hexagonal	5/8" x 18 thread
	405360	4	Retainer (washer) / Seguro (arandela) / Arrêt (rondelle)	5/8" I.D. x 2-3/16" O.D. x .120" thick
	405361-000	4	Bushing / Buje / Bague	1" centering lip for 5/8" O.D. stud (1.00" thick)
<b>141137</b>	402812	1	Sleeve / Camisa / Manchon	13 mm I.D. x 5/8 in. O.D. x 1-5/16 in. long
<b>141138</b>	401006	2	Hex nut / Tuerca hexagonal / Écrou hexagonal	3/8" x 24 UNF thread
	403489	4	Bushing / Buje / Bague	5/8" centering lip for 3/8" O.D. stud
	403575	4	Retainer (washer) / Seguro (arandela) / Arrêt (rondelle)	25/64" I.D. x 1-1/4" O.D. x .12" thick
	404949	4	Washer / Arandela / Rondelle	1/2" I.D. x 1-1/2" O.D. x .04" thick



**MOUNTING ACCESSORY PACKAGES AND COMPONENT PARTS**  
**KITS DE ACCESORIOS Y COMPONENTES**  
**ENSEMBLES D'ACCESSOIRES DE MONTURES ET DE PIÈCES DÉTACHÉES**

<b>141168</b>	401006	1	Hex nut / Tuerca hexagonal / Écrou hexagonal	3/8" x 24 UNF thread
	401008	1	Retainer (washer) / Seguro (arandela) / Arrêt (rondelle)	3/8 in. I.D. x 1-1/4 in. O.D. x .075 in. thick
	404350	1	Retainer (washer) / Seguro (arandela) / Arrêt (rondelle)	3/8 in. I.D. x 1-5/8 in. O.D. x .119 in. thick
	404985	1	Bushing / Buje / Bague	5/8" centering lip for 3/8" O.D. stud
	404986	1	Bushing / Buje / Bague	5/8" centering lip for 3/8" O.D. stud
	429680-015	1	Instruction sheet / Hoja de instr. / Feuillet d'instr.	
<b>141247</b>	401174	1	Hex nut / Tuerca hexagonal / Écrou hexagonal	5/8" x 18 thread
	401754	2	Bushing / Buje / Bague	EB3 - style for 2.39 in. O.D. eye ring - 1" diam. Stud
	405360	2	Retainer (washer) / Seguro (arandela) / Arrêt (rondelle)	5/8" I.D. x 2-3/16" O.D. x .120" thick
	405361	2	Bushing / Buje / Bague	1" centering lip for 5/8" O.D. stud
<b>141349</b>	401006	1	Hex nut / Tuerca hexagonal / Écrou hexagonal	3/8" x 24 UNF thread
	401007	1	Pal nut / Tuerca de cierre / Écrou Pal	3/8" x 24 UNF thread
	401376	2	Retainer (washer) / Seguro (arandela) / Arrêt (rondelle)	3/8 in. I.D. x 1-3/8 in. O.D. x .089 in. thick
	404652	2	Bushing / Buje / Bague	Used with 5/8" dia. hole or 7/8" dia. Hole
	429680-030	1	Instruction sheet / Hoja de instr. / Feuillet d'instr.	
<b>141350</b>	401006	1	Hex nut / Tuerca hexagonal / Écrou hexagonal	3/8" x 24 UNF thread
	401376	2	Retainer (washer) / Seguro (arandela) / Arrêt (rondelle)	3/8 in. I.D. x 1-3/8 in. O.D. x .089 in. thick
	402294	2	Bushing / Buje / Bague	5/8" lip for 3/8" dia. stud-5/8" or 7/8" holes
	411520	1	Jam nut / Contratuerca / Contre-Écrou	3/8" x 24 UNF thread
<b>141353</b>	401006	1	Hex nut / Tuerca hexagonal / Écrou hexagonal	3/8" x 24 UNF thread
	401007	1	Jam nut / Contratuerca / Contre-Écrou	3/8" x 24 UNF thread
	401383	2	Retainer (washer) / Seguro (arandela) / Arrêt (rondelle)	3/8 in. I.D. x 1-1/2 in. O.D. x .093 in. thick
	402263	2	Bushing / Buje / Bague	7/8" centering lip for 3/8" O.D. stud
<b>141354</b>	401006	1	Hex nut / Tuerca hexagonal / Écrou hexagonal	3/8" x 24 UNF thread
	401007	1	Pal nut / Tuerca de cierre / Écrou Pal	3/8" x 24 UNF thread
	404350	1	Retainer (washer) / Seguro (arandela) / Arrêt (rondelle)	3/8 in. I.D. x 1-5/8 in. O.D. x .119 in. thick
	404485	1	Retainer (washer) / Seguro (arandela) / Arrêt (rondelle)	0.453" I.D. x 1.63" O.D. x 0.120" thick
	404959	2	Bushing / Buje / Bague	3/4" centering lip for 7/16" O.D. stud
<b>141356</b>	401006	1	Hex nut / Tuerca hexagonal / Écrou hexagonal	3/8" x 24 UNF thread
	401007	1	Pal nut / Tuerca de cierre / Écrou Pal	3/8" x 24 UNF thread
	401008	2	Retainer (washer) / Seguro (arandela) / Arrêt (rondelle)	3/8 in. I.D. x 1-1/4 in. O.D. x .075 in. thick
	403962	2	Bushing / Buje / Bague	1/2" centering lip for 3/8" O.D. stud
<b>141368</b>	401006	1	Hex nut / Tuerca hexagonal / Écrou hexagonal	3/8" x 24 UNF thread
	401007	1	Jam nut / Contratuerca / Contre-Écrou	3/8" x 24 UNF thread
	401008	1	Retainer (washer) / Seguro (arandela) / Arrêt (rondelle)	3/8 in. I.D. x 1-1/4 in. O.D. x .075 in. thick
	401383	1	Retainer (washer) / Seguro (arandela) / Arrêt (rondelle)	3/8 in. I.D. x 1-1/2 in. O.D. x .093 in. thick
	403489	2	Bushing / Buje / Bague	5/8" centering lip for 3/8" O.D. stud
	429680-030	1	Instruction sheet / Hoja de instr. / Feuillet d'instr.	
<b>141376</b>	401006	1	Hex nut / Tuerca hexagonal / Écrou hexagonal	3/8 in.-24 thread
	401007	1	Pal nut / Tuerca de cierre / Écrou Pal	3/8" x 24 UNF thread
	401008	2	Retainer (washer) / Seguro (arandela) / Arrêt (rondelle)	3/8 in. I.D. x 1-1/4 in. O.D. x .075 in. thick
	403489	2	Bushing / Buje / Bague	5/8" centering lip for 3/8" O.D. stud
<b>141439</b>	401011	2	Bushing / Buje / Bague	EB2 style - for 1-3/4" O.D. eye ring - 3/4" diam. Stud
	411165	1	Lock nut / Contratuerca / Contre-Écrou	12 x 1.25 metric thread
	411445	2	Bushing / Buje / Bague	Flat Bushing for 9/16" O.D. stud
	411446	2	Retainer (washer) / Seguro (arandela) / Arrêt (rondelle)	3/4" I.D. x 1 7/8" O.D. x .047" thick
	411447	1	Retainer (washer) / Seguro (arandela) / Arrêt (rondelle)	9/16" I.D. x 1-3/4" O.D. x .087" thick
	412554	1	Retainer (washer) / Seguro (arandela) / Arrêt (rondelle)	0.485" O.D. x 1.76" O.D. x .089" thick

**MOUNTING ACCESSORY PACKAGES AND COMPONENT PARTS**  
**KITS DE ACCESORIOS Y COMPONENTES**  
**ENSEMBLES D'ACCESSOIRES DE MONTURES ET DE PIÈCES DÉTACHÉES**

<b>141448</b>	404715	1	Spacer / Espaciador / Entretoise	0.737" I.D x 1.75" O.D. x .120 thick
	411165	1	Lock nut / Contratuerca / Contre-Écrou	12 x 1.25 metric thread
	411445	2	Bushing / Buje / Bague	Flat Bushing for 9/16" O.D. stud
	411446	1	Retainer (washer) / Seguro (arandela) / Arrêt (rondelle)	3/4" I.D. x 1 7/8" O.D. x .047" thick
	411447	1	Washer / Arandela / Rondelle	9/16" I.D. x 1-3/4" O.D. x .087" thick
	412554	1	Retainer (washer) / Seguro (arandela) / Arrêt (rondelle)	0.485" O.D x 1.76" O.D. x .089" thick
<b>141514</b>	401006	1	Hex nut / Tuerca hexagonal / Écrou hexagonal	3/8" x 24 UNF thread
	401007	1	Pal nut / Tuerca de cierre / Écrou Pal	3/8" x 24 UNF thread
	401383	2	Retainer (washer) / Seguro (arandela) / Arrêt (rondelle)	3/8 in. I.D. x 1-1/2 in. O.D. x .093 in. thick
	404947	2	Bushing / Buje / Bague	3/8 in. I.D. x 1-3/16 in. x 9/16 in. thick
<b>141537</b>	401006	1	Hex nut / Tuerca hexagonal / Écrou hexagonal	3/8" x 24 UNF thread
	404350	2	Retainer (washer) / Seguro (arandela) / Arrêt (rondelle)	3/8 in. I.D. x 1-5/8 in. O.D. x .119 in. thick
	404985	2	Bushing / Buje / Bague	5/8" centering lip for 3/8" O.D. stud
<b>141665</b>	401006	1	Hex nut / Tuerca hexagonal / Écrou hexagonal	3/8" x 24 UNF thread
	402943	1	Retainer (washer) / Seguro (arandela) / Arrêt (rondelle)	0.457" I.D. x 1.68" O.D. x .120" thick
	403298	1	Retainer (washer) / Seguro (arandela) / Arrêt (rondelle)	0.390" I.D. x 1.68" O.D. x .120" thick
	404959	2	Bushing / Buje / Bague	3/4" centering lip for 7/16" O.D. stud
	411520	1	Jam nut / Contratuerca / Contre-Écrou	3/8" x 24 UNF thread
<b>142036</b>	411497	1	Lock nut / Contratuerca / Contre-Écrou	10 x 1.25 metric thread
<b>142069</b>	411165	2	Lock nut / Contratuerca / Contre-Écrou	12 x 1.25 metric thread
	411447	2	Washer / Arandela / Rondelle	9/16" I.D. x 1-3/4" O.D. x .087" thick
	412103	2	Retainer (washer) / Seguro (arandela) / Arrêt (rondelle)	9/16" I.D. x 1-3/4" O.D. x 1/4" thick
	412116	4	Bushing / Buje / Bague	Flat bushing for 9/16" O.D. Stud
	412554	2	Retainer (washer) / Seguro (arandela) / Arrêt (rondelle)	0.485" O.D x 1.76" O.D. x .089" thick
<b>142095</b>	411165	1	Lock nut / Contratuerca / Contre-Écrou	12 x 1.25 metric thread
	411447	2	Retainer (washer) / Seguro (arandela) / Arrêt (rondelle)	9/16" I.D. x 1-3/4" O.D. x .087" thick
	412103	1	Retainer (washer) / Seguro (arandela) / Arrêt (rondelle)	9/16" I.D. x 1-3/4" O.D. x 1/4" thick
	412116	2	Bushing / Buje / Bague	Flat bushing for 9/16" O.D. Stud
<b>142280</b>	411633	2	Bushing / Buje / Bague	0.810" centering lip for 7/16" O.D. stud
	411672	1	Retainer (washer) / Seguro (arandela) / Arrêt (rondelle)	0.410" I.D. x 2.05" O.D. x 0.175" thick
	412046	1	Lock nut / Contratuerca / Contre-Écrou	10 x 1.5 metric thread
	412479	1	Retainer (washer) / Seguro (arandela) / Arrêt (rondelle)	0.490" I.D. x 2.15" O.D. x 0.180" thick
<b>142389</b>	404287	2	Retainer (washer) / Seguro (arandela) / Arrêt (rondelle)	0.453" I.D x 1.50" O.D x 0.090" thick
	404947	2	Bushing / Buje / Bague	For 3/8" O.D. stud- no centering lip
	411497	1	Lock nut / Contratuerca / Contre-Écrou	10 x 1.25 metric thread
<b>142592</b>	402539	2	Bolt / Tornillo / Boulon	5/16" x 24 UNF thread x 1" long
	402573	2	Nut / Tuerca / Écrou	5/16" x 24 UNF thread
	402653	2	Lock washer / Arandela de seguridad / Rondelle-frein	5/16" Lock washer
	411385	2	Retainer (washer) / Seguro (arandela) / Arrêt (rondelle)	0.355" I.D x 0.74" O.D. x 0.075" thick
<b>142615</b>	401006	1	Hex nut / Tuerca hexagonal / Écrou hexagonal	3/8" x 24 UNF thread
	401376	1	Retainer (washer) / Seguro (arandela) / Arrêt (rondelle)	3/8 in. I.D. x 1-3/8 in. O.D. x .089 in. thick
	402943	1	Retainer (washer) / Seguro (arandela) / Arrêt (rondelle)	0.457" I.D. x 1.68" O.D. x .120" thick
	404652	2	Bushing / Buje / Bague	Used with 5/8" dia. hole or 7/8" dia. Hole
<b>142617</b>	401006	1	Hex nut / Tuerca hexagonal / Écrou hexagonal	3/8" x 24 UNF thread
	402943	1	Retainer (washer) / Seguro (arandela) / Arrêt (rondelle)	0.457" I.D. x 1.68" O.D. x .120" thick
	403298	1	Retainer (washer) / Seguro (arandela) / Arrêt (rondelle)	0.390" I.D. x 1.68" O.D. x .120" thick
	412661	2	Bushing / Buje / Bague	0.790" centering lip for 7/16" O.D. stud

**MOUNTING ACCESSORY PACKAGES AND COMPONENT PARTS**  
**KITS DE ACCESORIOS Y COMPONENTES**  
**ENSEMBLES D'ACCESSOIRES DE MONTURES ET DE PIÈCES DÉTACHÉES**

<b>142656</b>	411165	1	Lock nut / Contratuerca / Contre-Écrou	12 x 1.25 metric thread
	411446	1	Retainer (washer) / Seguro (arandela) / Arrêt (rondelle)	3/4" I.D. x 1 7/8" O.D. x .047" thick
	411447	1	Retainer (washer) / Seguro (arandela) / Arrêt (rondelle)	9/16" I.D. x 1-3/4" O.D. x .087" thick
	412103	1	Retainer (washer) / Seguro (arandela) / Arrêt (rondelle)	9/16" I.D. x 1-3/4" O.D. x 1/4" thick
	412116	2	Bushing / Buje / Bague	Flat bushing for 9/16" O.D. Stud
	412554	1	Retainer (washer) / Seguro (arandela) / Arrêt (rondelle)	0.485" O.D x 1.76" O.D. x .089" thick
<b>142657</b>	411165	2	Lock nut / Contratuerca / Contre-Écrou	12 x 1.25 metric thread
	411446	2	Retainer (washer) / Seguro (arandela) / Arrêt (rondelle)	3/4" I.D. x 1 7/8" O.D. x .047" thick
	411447	2	Retainer (washer) / Seguro (arandela) / Arrêt (rondelle)	9/16" I.D. x 1-3/4" O.D. x .087" thick
	412103	2	Retainer (washer) / Seguro (arandela) / Arrêt (rondelle)	9/16" I.D. x 1-3/4" O.D. x 1/4" thick
	412116	4	Bushing / Buje / Bague	Flat bushing for 9/16" O.D. Stud
	412554	2	Retainer (washer) / Seguro (arandela) / Arrêt (rondelle)	0.485" O.D x 1.76" O.D. x .089" thick
<b>142700</b>	401006	1	Hex nut / Tuerca hexagonal / Écrou hexagonal	3/8" x 24 UNF thread
	402943	1	Retainer (washer) / Seguro (arandela) / Arrêt (rondelle)	0.457" I.D. x 1.68" O.D. x .120" thick
	403298	1	Retainer (washer) / Seguro (arandela) / Arrêt (rondelle)	0.390" I.D. x 1.68" O.D. x .120" thick
	404959	2	Bushing / Buje / Bague	3/4" centering lip for 7/16" O.D. stud
	411520	1	Jam nut / Contratuerca / Contre-Écrou	3/8" x 24 UNF thread
	412682	1	Sleeve / Camisa / Manchon	0.479" I.D. x 0.548" O.D. x 1.48" long
	429680-008	1	Instruction sheet / Hoja de instr. / Feuillet d'instr.	
<b>142731</b>	411165	1	Lock nut / Contratuerca / Contre-Écrou	12 x 1.25 metric thread
	411447	1	Retainer (washer) / Seguro (arandela) / Arrêt (rondelle)	9/16" I.D. x 1-3/4" O.D. x .087" thick
	412554	1	Retainer (washer) / Seguro (arandela) / Arrêt (rondelle)	0.485" O.D x 1.76" O.D. x .089" thick
	412675	2	Bushing / Buje / Bague	0.950" centering lip for 9/16" O.D. stud
<b>142973</b>	411633	2	Bushing / Buje / Bague	0.810" centering lip for 7/16" O.D. stud
	411672	1	Retainer (washer) / Seguro (arandela) / Arrêt (rondelle)	0.410" I.D. x 2.05" O.D. x 0.175" thick
	412046	1	Lock nut / Contratuerca / Contre-Écrou	10 x 1.5 metric thread
	412479	1	Retainer (washer) / Seguro (arandela) / Arrêt (rondelle)	0.490" I.D. x 2.15" O.D. x 0.180" thick
<b>142976</b>	401174	1	Hex nut / Tuerca hexagonal / Écrou hexagonal	5/8" x 18 thread
	405360	2	Retainer (washer) / Seguro (arandela) / Arrêt (rondelle)	5/8" I.D. x 2-3/16" O.D. x .120" thick
	405361-000	2	Bushing / Buje / Bague	1" centering lip for 5/8" O.D. stud (1.00" thick)
	429680-031	1	Instruction sheet / Hoja de instr. / Feuillet d'instr.	
<b>142998</b>	404452	2	Retainer (washer) / Seguro (arandela) / Arrêt (rondelle)	5/8" I.D. x 2-3/4" O.D. x .180" thick
	404454	2	Bushing / Buje / Bague	1-3/16" centering lip for 13/16" O.D. stud
	405862	1	Self locking nut / Tuerca de seguridad / Écrou indesserrable	5/8" x 18 thread
	412872	1	Sleeve / Camisa / Manchon	0.643" I.D. x .815" O.D. x 1.44" long
<b>143000</b>	404695	1	Retainer (washer) / Seguro (arandela) / Arrêt (rondelle)	0.709" centering lip x 1.97" O.D. x .060" thick
	404715	1	Spacer / Espaciador / Entretoise	0.737" I.D x 1.75" O.D. x .120 thick
	411165	1	Lock nut / Contratuerca / Contre-Écrou	12 x 1.25 metric thread
	411447	1	Retainer (washer) / Seguro (arandela) / Arrêt (rondelle)	9/16" I.D. x 1-3/4" O.D. x .087" thick
	412116	2	Bushing / Buje / Bague	Flat bushing for 9/16" O.D. Stud
	412554	1	Retainer (washer) / Seguro (arandela) / Arrêt (rondelle)	0.485" O.D x 1.76" O.D. x .089" thick
	429680-033	1	Instruction sheet / Hoja de instr. / Feuillet d'instr.	
<b>143078</b>	401006	1	Hex nut / Tuerca hexagonal / Écrou hexagonal	3/8" x 24 UNF thread
	404969	1	Sleeve / Camisa / Manchon	0.400" I.D. x .620" O.D. x 1.48" long
	412554	2	Retainer (washer) / Seguro (arandela) / Arrêt (rondelle)	0.485" O.D x 1.76" O.D. x .089" thick
	412675	2	Bushing / Buje / Bague	0.950" centering lip for 9/16" O.D. stud
<b>143146</b>	411165	1	Lock nut / Contratuerca / Contre-Écrou	12 x 1.25 metric thread
	411447	2	Retainer (washer) / Seguro (arandela) / Arrêt (rondelle)	9/16" I.D. x 1-3/4" O.D. x .087" thick
	412675	2	Bushing / Buje / Bague	0.950" centering lip for 9/16" O.D. stud

**MOUNTING ACCESSORY PACKAGES AND COMPONENT PARTS**  
**KITS DE ACCESORIOS Y COMPONENTES**  
**ENSEMBLES D'ACCESSOIRES DE MONTURES ET DE PIÈCES DÉTACHÉES**

<b>145054</b>	401174	1	Hex nut / Tuerca hexagonal / Écrou hexagonal	5/8 in. -18 thread
	401175	1	Lock washer / Arandela de seguridad / Rondelle-frein	
	405360	2	Retainer (washer) / Seguro (arandela) / Arrêt (rondelle)	5/8" I.D. x 2-3/16" O.D. x .120" thick
	405361-000	2	Bushing / Buje / Bague	1" centering lip for 5/8" O.D. stud (1.00" thick)
<b>145075</b>	401750	1	Retainer (washer) / Seguro (arandela) / Arrêt (rondelle)	3/4" I.D. x 2-3/8" O.D. x .105" thick
	401752	1	Retainer (washer) / Seguro (arandela) / Arrêt (rondelle)	1" I.D. x 2-3/8" O.D. x .105" thick
	401754	2	Bushing / Buje / Bague	EB3 - style for 2.39 in. O.D. eye ring - 1" diam. Stud
	405360	2	Retainer (washer) / Seguro (arandela) / Arrêt (rondelle)	5/8" I.D. x 2-3/16" O.D. x .120" thick
	405361-000	2	Bushing / Buje / Bague	1" centering lip for 5/8" O.D. stud (1.00" thick)
	<b>145080</b>	401011	2	Bushing / Buje / Bague
401429		1	Retainer (washer) / Seguro (arandela) / Arrêt (rondelle)	1/2" I.D. x 1-5/8" O.D. x .090" thick
401430		1	Retainer (washer) / Seguro (arandela) / Arrêt (rondelle)	3/4" I.D. x 1-5/8" O.D. x .090" thick
<b>145089-000</b>	405360	2	Retainer (washer) / Seguro (arandela) / Arrêt (rondelle)	5/8" I.D. x 2-3/16" O.D. x .120" thick
	405361-000	2	Bushing / Buje / Bague	1" centering lip for 5/8" O.D. stud (1.00" thick)
	405862	1	Self locking nut / Tuerca de seguridad / Écrou indesserrable	5/8" x 18 thread
<b>145089-200</b>	405360	2	Retainer (washer) / Seguro (arandela) / Arrêt (rondelle)	5/8" I.D. x 2-3/16" O.D. x .120" thick
	405361-100	2	Bushing / Buje / Bague	1" centering lip for 5/8" O.D. stud (0.75" thick)
	415196-001	1	Nylon lock nut / Contratuerca / Contre-Écrou	5/8" x 18 thread
<b>145090</b>	405643	1	Sleeve / Camisa / Manchon	0.645" I.D x 0.810" O.D. x 2.00" long
	405859	2	Bushing / Buje / Bague	0.815" I.D. x 2.35" O.D x 1.05" thick with 1.15" centering lip
	405860	2	Retainer (washer) / Seguro (arandela) / Arrêt (rondelle)	0.650" I.D. x 2.75" O.D. x .180" thick
	405862	1	Self locking nut / Tuerca de seguridad / Écrou indesserrable	5/8" x 18 thread
	424276	1	Instruction sheet / Hoja de instr. / Feuillet d'instr.	
	<b>145093</b>	401750	2	Retainer (washer) / Seguro (arandela) / Arrêt (rondelle)
401752		2	Retainer (washer) / Seguro (arandela) / Arrêt (rondelle)	1" I.D. x 2-3/8" O.D. x .105" thick
401754		4	Bushing / Buje / Bague	EB3 - style for 2.39 in. O.D. eye ring - 1" diam. Stud
<b>145099</b>	401174	1	Hex nut / Tuerca hexagonal / Écrou hexagonal	5/8" x 18 thread
	401175	1	Lock washer / Arandela de seguridad / Rondelle-frein	
	401754	2	Bushing / Buje / Bague	EB3 - style for 2.39 in. O.D. eye ring - 1" diam. Stud
	405360	2	Retainer (washer) / Seguro (arandela) / Arrêt (rondelle)	5/8" I.D. x 2-3/16" O.D. x .120" thick
	405361-000	2	Bushing / Buje / Bague	1" centering lip for 5/8" O.D. stud (1.00" thick)
	424274	1	Instruction sheet / Hoja de instr. / Feuillet d'instr.	
<b>145112</b>	401164	1	Hex nut / Tuerca hexagonal / Écrou hexagonal	1/2" x 20 UNF Thread
	401165	1	Lock washer / Arandela de seguridad / Rondelle-frein	1/2" lock washer
	405360	1	Retainer (washer) / Seguro (arandela) / Arrêt (rondelle)	5/8" I.D. x 2-3/16" O.D. x .120" thick
	405361-000	2	Bushing / Buje / Bague	1" centering lip for 5/8" O.D. stud (1.00" thick)
	405934	1	Retainer (washer) / Seguro (arandela) / Arrêt (rondelle)	0.530" I.D. x 2-3/16" O.D. x .120" thick
	<b>145116</b>	401750	1	Retainer (washer) / Seguro (arandela) / Arrêt (rondelle)
401752		1	Retainer (washer) / Seguro (arandela) / Arrêt (rondelle)	1" I.D. x 2-3/8" O.D. x .105" thick
415169		2	Bushing / Buje / Bague (Durometer 80)	EB3 - style for 2.39 in. O.D. eye ring - 1" diam. Stud
<b>145123</b>	405360	2	Retainer (washer) / Seguro (arandela) / Arrêt (rondelle)	5/8" I.D. x 2-3/16" O.D. x .120" thick
	405862	1	Self locking nut / Tuerca de seguridad / Écrou indesserrable	5/8" x 18 thread
	415017-001	2	Bushing / Buje / Bague	1" centering lip for a 5/8" O.D. stud
<b>145126</b>	401750	2	Retainer (washer) / Seguro (arandela) / Arrêt (rondelle)	3/4" I.D. x 2-3/8" O.D. x .105" thick
	401754	2	Bushing / Buje / Bague	EB3 - style for 2.39 in. O.D. eye ring - 1" diam. Stud
	403752	1	Sleeve / Camisa / Manchon	3/4" I.D. x 15/16" O.D. x 1-3/4" long
	415277	1	Spacer / Espaciador / Entretoise	1-3/16" I.D. x 1-1/4" O.D. x .200" thick
	424281	1	Instruction sheet / Hoja de instr. / Feuillet d'instr.	

**MOUNTING ACCESSORY PACKAGES AND COMPONENT PARTS**  
**KITS DE ACCESORIOS Y COMPONENTES**  
**ENSEMBLES D'ACCESSOIRES DE MONTURES ET DE PIÈCES DÉTACHÉES**

<b>145128</b>	405360	2	Retainer (washer) / Seguro (arandela) / Arrêt (rondelle)	5/8" I.D. x 2-3/16" O.D. x .120" thick
	405361-000	2	Bushing / Buje / Bague	1" centering lip for 5/8" O.D. stud (1.00" thick)
	415196-001	1	Nylon lock nut / Contratuercia / Contre-Écrou	5/8" x 18 thread
<b>145132</b>	415305-000	2	Rubber spacer / Espaciador de goma / Entretoise de caout.	0.910" I.D. x 1.58" O.D. x 1.1" long
	415305-001	2	Rubber spacer / Espaciador de goma / Entretoise de caout.	0.910" I.D. x 1.58" O.D. x 0.427" long
	424282	1	Instruction sheet / Hoja de instr. / Feuillet d'instr.	
<b>145140</b>	405360	2	Retainer (washer) / Seguro (arandela) / Arrêt (rondelle)	5/8" I.D. x 2-3/16" O.D. x .120" thick
	405862	1	Self locking nut / Tuerca de seguridad / Écrou indesserrable	5/8" x 18 thread
	415326-001	2	Urethane bushing / Buje de uretano / Bague urÉthane	1" centering lip for 5/8" O.D. stud (replacing Bushing P/N 415017)
<b>145143</b>	415305-001	2	Rubber spacer / Espaciador de goma / Entretoise de caout.	0.910" I.D. x 1.58" O.D. x 0.427" long
	424284	1	Instruction sheet / Hoja de instr. / Feuillet d'instr.	
<b>145144</b>	415305-000	2	Rubber spacer / Espaciador de goma / Entretoise de caout.	0.910" I.D. x 1.58" O.D. x 1.1" long
	424284	1	Instruction sheet / Hoja de instr. / Feuillet d'instr.	
<b>145147</b>	401429	1	Retainer (washer) / Seguro (arandela) / Arrêt (rondelle)	1/2" I.D. x 1-5/8" O.D. x .090" thick
	401430	1	Retainer (washer) / Seguro (arandela) / Arrêt (rondelle)	3/4" I.D. x 1-5/8" O.D. x .090" thick
<b>145148</b>	401750	1	Retainer (washer) / Seguro (arandela) / Arrêt (rondelle)	3/4" I.D. x 2-3/8" O.D. x .105" thick
	401752	1	Retainer (washer) / Seguro (arandela) / Arrêt (rondelle)	1" I.D. x 2-3/8" O.D. x .105" thick
<b>145149</b>	401265	1	Retainer (washer) / Seguro (arandela) / Arrêt (rondelle)	1/2" I.D. x 1-1/4" O.D. x .075" thick
	401266	1	Retainer (washer) / Seguro (arandela) / Arrêt (rondelle)	5/8" I.D. x 1-1/4" O.D. x .075" thick
<b>145168</b>	405643-100	1	Sleeve / Camisa / Manchon	0.645" I.D. x 0.810" O.D. x 1.50" long
	405859-100	2	Bushing / Buje / Bague	0.815" I.D. x 2.35" O.D. x 0.800" thick with 1.15" centering lip
	405860	2	Retainer (washer) / Seguro (arandela) / Arrêt (rondelle)	0.650" I.D. x 2.75" O.D. x .180" thick
	405862	1	Self locking nut / Tuerca de seguridad / Écrou indesserrable	5/8" x 18 thread
	424276	1	Instruction sheet / Hoja de instr. / Feuillet d'instr.	
<b>145177</b>	401754	2	Bushing / Buje / Bague	EB3 - style for 2.39 in. O.D. eye ring - 1" diam. Stud
	406422-000	2	Retainer (washer) / Seguro (arandela) / Arrêt (rondelle)	22 mm I.D. x 60.2 mm O.D. x 2.7 mm thick
	415010-802	1	Sleeve / Camisa / Manchon	22 mm I.D. x 1.00" O.D. x 1-3/4" long
	424296-000	1	Instruction sheet / Hoja de instr. / Feuillet d'instr.	
<b>145178</b>	404452	2	Retainer (washer) / Seguro (arandela) / Arrêt (rondelle)	5/8" I.D. x 2-3/4" O.D. x .180" thick
	404454	2	Bushing / Buje / Bague	1-3/16" centering lip for 13/16" O.D. stud
	412872	1	Sleeve / Camisa / Manchon	0.643" I.D. x .815" O.D. x 1.44" long
	415196-001	1	Nylon lock nut / Contratuercia / Contre-Écrou	5/8" x 18 thread
<b>401011</b>		1	Bushing / Buje / Bague	EB2 style - for 1-3/4" O.D. eye ring - 3/4" diam. Stud - Replaced by TR0027
<b>401754</b>		1	Bushing / Buje / Bague	EB3 - style for 2.39 in. O.D. eye ring - 1" diam. Stud
<b>404702</b>		1	Bushing / Buje / Bague	EB1 style - 1 pc Spool shaped bushing (5/8" I.D.)
<b>405360</b>		1	Retainer (washer) / Seguro (arandela) / Arrêt (rondelle)	5/8" I.D. x 2-3/16" O.D. x .120" thick
<b>405361-000</b>		1	Bushing / Buje / Bague	1" centering lip for 5/8" O.D. stud (1.00" thick)
<b>406422</b>		1	Retainer (washer) / Seguro (arandela) / Arrêt (rondelle)	22 mm I.D. x 60.2 mm O.D. x 2.7 mm thick
<b>415010-802</b>		1	Sleeve / Camisa / Manchon	22 mm I.D. x 1.00" O.D. x 1-3/4" long
<b>415015-001</b>		1	Urethane bushing / Buje de uretano / Bague urÉthane	EB3 - style for 2.39 in. O.D. eye ring - 1" diam. Stud
<b>415017</b>		1	Urethane bushing / Buje de uretano / Bague urÉthane	1" centering lip for 5/8" O.D. stud
<b>415025-001</b>		1	Urethane bushing / Buje de uretano / Bague urÉthane	EB2 style for 1-3/4" O.D. eye ring - 3/4" diam. Stud
<b>415326-001</b>		1	Urethane bushing / Buje de uretano / Bague urÉthane	1" centering lip for 5/8" O.D. stud (replacing Bushing P/N 415017)
<b>TR0027</b>		1	Bushing / Buje / Bague	EB2 style - for 1-3/4" O.D. eye ring - 3/4" diam. Stud - (Replaces 401011)

**MOUNTING ACCESSORY PACKAGES - BUYER'S GUIDE**  
**KITS DE ACCESORIOS – GUÍA DEL COMPRADOR**  
**ENSEMBLE D'ACCESSOIRES POUR LA FIXATION - GUIDE DE L'ACHETEUR**

Kit #	Gabriel #
<b>140126</b>	83027
	G63350
	G63359
	G63360
	G63387
	G63457
	G63881
<b>140149</b>	83200
	83216
	83219
	83308
	83309
	83312
	83314
	85023
	85024
	85046
	85047
	89401
	89402
	89403
	89409
	89415
	89416
	89434
	89435
G63494	
G63510	
<b>140169</b>	85025
	G63432
	G63605
	G63616
	G63708
<b>140357</b>	G63349
	G63438
<b>140455</b>	83003
	83005
	83014
	83015
	83400
	G63421
	G63798
	G63860

Kit #	Gabriel #
	G63862
	G63950
<b>140524</b>	83161
	G63479
	G63484
	G63491
	G63611
	G63635
<b>140673</b>	G63900
	G63937
<b>140702</b>	83007
	83303
	83304
	G63355
	G63394
	G63625
<b>140719</b>	G63607
	G63679
<b>140780</b>	83018
	83019
	83041
	83045
	83050
	83058
	83105
	83114
	83162
	83177
	G63386
	G63396
	G63414
G63416	
G63445	
G63447	
G63500	
G63603	
G63608	
G63614	
G63621	
G63624	
G63929	
<b>140857</b>	G63902

Kit #	Gabriel #
<b>140884</b>	G63405
<b>140885</b>	G63299
<b>140921</b>	G63548
	G63726
<b>141041</b>	83515
	83518
	G63444
	G63889
	G64004
	G64005
	G64006
	G64007
<b>141047</b>	G63410
	G63446
<b>141083</b>	83301
	83317
	83318
	83613
<b>141108</b>	85310
	89423
	89447
	89455
<b>141137</b>	G63377
	G63492
	G63712
<b>141138</b>	G63187
	G63398
<b>141247</b>	85311
	85312
	85317
	85703
	87000
	89424
<b>141277</b>	G63489
<b>143146</b>	85649
<b>141349</b>	G63404
	G63432
<b>141350</b>	G63495
	G63547
	G63781
	G63782
<b>141353</b>	G63424

**MOUNTING ACCESSORY PACKAGES - BUYER'S GUIDE**  
**KITS DE ACCESORIOS – GUÍA DEL COMPRADOR**  
**ENSEMBLE D'ACCESSOIRES POUR LA FIXATION - GUIDE DE L'ACHETEUR**

Kit #	Gabriel #
	G63511
	G63847
<b>141354</b>	G63707
<b>141356</b>	G63418
	G63904
<b>141368</b>	G63909
<b>141376</b>	G63903
<b>141405</b>	G63620
<b>141439</b>	G63434
<b>141448</b>	G63506
	G63694
<b>141514</b>	G63799
<b>141665</b>	G63721
	G63772
	G63783
	G63803
	G63817
<b>142036</b>	G63884
<b>142095</b>	83178
<b>142280</b>	G63885
<b>142389</b>	G63610
	G63865
<b>142592</b>	G63847
<b>142615</b>	G63375
<b>142617</b>	G63622
	G63623
<b>142656</b>	G63616
<b>142657</b>	G63615
<b>142700</b>	G63715
	G63778
<b>142731</b>	G63674
	G63714
	G63716
	G63848
	G63886
	G64009
	G64011
<b>142973</b>	G64008
<b>142976</b>	G63828
	G63832
<b>142998</b>	83456
<b>143000</b>	G63661
	G63673
<b>143078</b>	G63894

Kit #	Gabriel #
	G63895
	G63958
	G64001
<b>143146</b>	85649
	G63969
<b>143276</b>	G63893
	G63894
	G63895
<b>145054</b>	83103
	83106
	83134
	83136
	83395
	83635
	85009
	85025
	85026
	85027
	85049
	85071
	85080
	85085
	85092
	85124
	85126
	85318
	85324
	85325
	85326
	85328
	85330
	85336
	85342
	85379
	85701
	85710
	85711
	85731
	85900
	85902
	85921
	89417
	89418
	89441

Kit #	Gabriel #
<b>145075</b>	85723
<b>145080</b>	83107
	85012
	85054
	85055
	85062
	85063
	89408
	89413
	89438
	89439
<b>145089-000</b>	83102
	83120
	83154
	85069
	85122
	85319
	85340
	85341
	85343
	85733
	85970
	89428
<b>145089-200</b>	85182
	85936
	85937
	85985
	89456
<b>145090</b>	87016
	695406
	85081
	85123
	85316
	85346
	85347
	85351
	85380
	85705
	85706
	85707
	85708
	85709
	85722
	85740



**MOUNTING ACCESSORY PACKAGES - BUYER'S GUIDE**  
**KITS DE ACCESORIOS – GUÍA DEL COMPRADOR**  
**ENSEMBLE D'ACCESSOIRES POUR LA FIXATION - GUIDE DE L'ACHETEUR**

Kit #	Gabriel #
	85745
	85746
	85935
	89426
<b>145093</b>	85714
	85715
	85716
	85717
	85718
	85719
<b>145099</b>	83353
	85033
	85988
	89427
<b>145116</b>	83162
	85732
	87016
<b>145126</b>	85053
	89442
<b>145128</b>	83062
	83109
	83110
	83111
	83112
	83138
	83142
	83143
	85065
	85083
	85332
	85333
	85977
<b>145143</b>	83120
<b>145147</b>	85031
<b>145148</b>	83140
	83141
<b>145176</b>	85727
	85728
	85729
<b>145177</b>	83391
<b>145178</b>	83244
<b>401011</b>	83519

Kit #	Gabriel #
<b>401754</b>	85343
	85380
	85740
	83132
	83214
	83215
	83217
	83225
	83362
	85001
	85004
	85007
	85040
	85042
	85057
	85070
	85300
	85301
	85302
	85303
	85304
	85305
	85307
	85308
	85313
	85314
	85315
	85320
	85322
	85327
	85329
	85334
	85339
	85376
	85700
	85702
	85703
	85704
	85710
	85711
	85712
	85713

Kit #	Gabriel #
	85720
	85729
	85730
	85731
	85734
	85735
	85736
	85901
	85905
	85912
	85913
	85915
	85968
	87001
	87002
	87003
	87004
	87006
	89410
	89412
	89419
	89420
	89422
	89425
	89429
	89459
<b>406422</b>	83162
<b>415010-802</b>	83140
	83141
	83162
<b>TR0027</b>	83159
	83404
	83518
	83519
	85031
	89446





# HERE TO HELP



**800.999.3903 | ANSWERGARAGE.COM**



**Ride Control Answer Garage/Tech Line:**

**800.999.3903**

For application, technical and product questions  
Monday - Friday, 9AM - 4PM ET

**Gabriel Customer Service:**

**800.251.5932**

To place and track orders  
Monday - Friday, 7AM - 5PM CT

## Check out our Training Videos:

**How to Check Your HD Shocks**



**Installation Tips**



**How to Maximize Tire & Air Spring Life**



**Misting vs. Leaking Shocks**



**Top 5 Reasons why FleetLine® is the best HD shock**



**FIND MORE AT GABRIEL.COM**  
part lookup, product info, technical help & training



Ride Control, LLC, 39300 Country Club Dr.  
Farmington Hills, MI 48331, 248.247.7600